

PRODUCT CATALOGUE

CLA
Lighting



ISSUE 2024-2025



CLA LIGHTING

Operating as a 100% Australian owned company, we are proud to have come a long way since we began in 1999, on the Northern Beaches of Sydney. Since its inception, CLA has continuously evolved to keep abreast of the latest in national and international lighting trends to provide benchmark technology in our diverse range of lighting products. These include indoor and outdoor decorative lighting, high-quality energy saving lamps, trendy lighting fixtures and related products for all commercial, industrial, residential and utility markets.

All our products are manufactured to comply with all Australian and New Zealand standards and we are a proud member of the Australian Lighting Council. With warehouses strategically located across Australia & New Zealand, we ensure prompt dispatch and delivery. We use our strength as a lighting leader to provide you with superior customer service, innovative lighting solutions, quality and performance.

This New 2024-2025 catalogue makes us proud to show case the depth in niche product range CLA has to offer.

Decor Lighting

Interior Pendant Lights	18-162
Ceiling Spot Lights	163-170
Table & Floor Lamps	171-182
Interior Wall Lights	183-213
D.I.Y. Decor Lighting	214-223

Exterior Lighting

Exterior Pendant Lights	226-227
Exterior Wall Lights	225-226, 228-260
Bulkheads	261-266
Exterior Ceiling / Oyster Lights	267-269
Exterior Step Lights	270-277
Pillar Lights	278-307
Pillar, Wall & Bollard Lights	308-322
Garden Spike Lights	323-327
Pond Light	328
Deck Lights & Inground Up Lights	329-333
Flood Lights	334-337
Exterior Battens	338

General Lighting

Downlights	339-356
Spot Lights	357-364
Oyster Lights	365-369
Battens	370-374
Connectable Track Systems	375-391
Interior Utility Lights	392-397
High Bay	398-399
Security Lights	400-406

Globes

LED Globes	407-442
Fluorescent Globes	443-446
Carbon Filament Globes	447-450
Heat Lamp Globes	451-452

Accessories

Electrical Accessories	453-471
Control Gear	472-476
Team Brand Products	477-494

Decor

Interior Pendant Lights



CLESSIDRA
P 19-21



MANGA
P 22-23



BANQUET
P 24



VIRUN
P 25



BARRIQUE
P 26-27



VOTIF
P 28



DIABLO
P 29



MARACA
P 30



BROTE
P 31



PELOTA
P 32-33



VINTAJ1-6
P 35



VINTAJ7-12
P 36



VINTAJ13-18
P 37



MARBRE
P 38



GOLPE
P 39



CEREMA
P 40-41



SARI
P 42



CANAMO
P 43



COUP
P 44-45



ROTA
P 46



CESTA
P 47



CANASTA
P 48



ORIGAMI
P 49



TUILE
P 50



BOTANICA
P 51



MARRAKESH
P 52-55



PATERA
P 56



PESINI
P 57



VINUM
P 58



ROCHE
P 59



JEREZ
P 60-61



CHAMPAN
P 62-63



TRATTINO
P 64-65



TULIP
P 66-67



ESPEJO
P 68-71



CIOTOLA
P 72-73



FOSSETTE
P 74-75



MIKRO
P 76



CORAZON
P 77



IDA
P 78



GOLDA
P 79



VAINA
P 80



BELLA
P 81



ESCAMA
P 82



CLEO
P 83



PASTILLE
P 84



PAPILLON
P 85



CHAPEAU
P 86



CONTOUR
P 87



ABBEY
P 88-89



HEXADE
P 90



HEXA
P 91



STRATO
P 92



MAZZA
P 93



SPUTNIK
P 94



HOPI
P 95



BONITO
P 96-97



KHALEESI
P 98



METI
P 99



SENRITA
P 100



PENDOLO
P 101



AUTUMN
P 102-103



TAMBURA
P 104-105



SWING
P 106-107



NORDIC
P 108



HORTEN
P 109



FARO
P 110



LANTERNA
P 111



LIGNA
P 112-113



ZARA
P 114-115



ARMIS
P 116-117



FINN
P 118



LEGNA
P 119



CELESTE
P 120



KOPER
P 121



MODELLO
P 122



RICTUS
P 123



GLAZE1-5
P 124



GLAZE10-11
P 125



ORDITO
P 126



CHUVA
P 127



MASON
P 128-129



CASA
P 130



FUMOSO
P 131



LAMINA
P 132



TONO
P 133



PENOLA
P 134



RIVERINA
P 134



MARTE
P 135



GAMBA
P 136-137



CHEVEUX
P 138-139



STRAND
P 140



SPIAGGIA
P 141



MANU
P 142



VENETO
P 143



SENTINEL
P 144



BLACKBAND
P 145-148



WHITEBAND
P 147-148



MATRIX
P 149



PASTEL01-07
P 150



PASTEL08-14
P 151



ALTA
P 152



NARVIK
P 153



DIVO
P 154-155



DEKSEL
P 156-157



CAVIAR
P 158



CLASSIC
P 159



PIATTO
P 160



PEN
P 161



CLUSTER
P 162

Decor Ceiling Spot Lights



SPOT
P 164-165

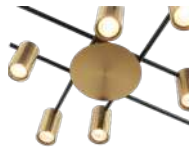

TACHE
P 166-170

Decor Table and Floor Lamps



FLATMATE
P 172



PENMATE
P 173



BUDDY
P 174



LOTUS
P 175



TAMBURA TL
P 176



TAMBURA FL
P 177



PASTEL TL
P 178



PASTEL FL
P 179



FOKUS
P 180



VENETO
P 181



AUTUMN
P 182

Decor

Interior Wall Lights



CLESSIDRA
P 184



VINUM
P 185



PESINI
P 186



STRUNG
P 187



ALTA
P 188



STEAM
P 189



AUTUMN
P 189



VENETO
P 190



DEKSEL
P 191



METI
P 192



SPUTNIK
P 192

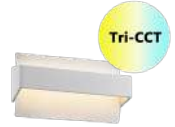

ATLANTA
P 193

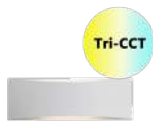

BRISTOL
P 193



BAGOTA
P 194

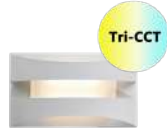

CARDIFF
P 195



DHAKA
P 195



HELSINKI
P 195

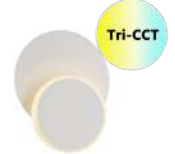

LIMA1
P 196



LIMA2
P 196

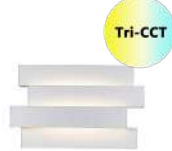

NAGOYA
P 197



SANTIAGO
P 198



SURAT
P 198



TIJUANA
P 198



ATHENS
P 199



BARCELONA
P 199



CANNES
P 199



DAVOS
P 200



DELHI
P 200

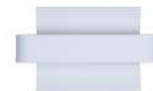

DUBAI
P 200



LONDON
P 201



NEW YORK
P 201



PARIS
P 202



PHOENIX
P 202



RIO
P 202



ROME
P 203



SYDNEY
P 203



VENICE
P 203



VIENNA
P 204



CHESTER
P 204



SEATTLE
P 205



LYON
P 206



VIGO
P 206



BRIGHTON
P 207



VANITAS
P 208-209



LINEAL
P 210-211



VANIDAD
P 212



VANITY
P 213

Decor D.I.Y. Decor Lighting



DIYPEN
P 215



DIYBAT01-04
P 216



DIYBAT05-08
P 217



DIYBAT09-12
P 218



DIYBAT13-16
P 219



DIYBAT17-20
P 220



DIYBATC
P 221



SHADE01-04
P 222



SHADE05-08
P 223

Exterior Lighting



RUBIK
P 225



SPY
P 226



TREET
P 227



SKOPA
P 228



DEKSEL
P 229



HINK
P 230



MAGNUM
P 231



TORQUE1-2
P 232



TORQUE3-4
P 233



CRISTAL
P 234



GIROTRI
P 235



HAK
P 236

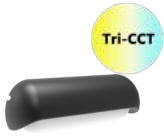

AKENTRI
P 237

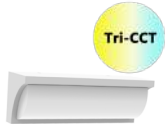

REPISATRI
P 238

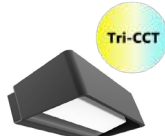

TOPATRI
P 239



BOCINA
P 240



PLANA
P 241



SOMBRA
P 242



WIG
P 243



BES
P 244



OLA
P 245



GLANS
P 246



APIS
P 247



ATEN
P 248



MARINA
P 249



HEKA
P 250



KUK
P 251



TOCA1-2
P 252



TOCA3-4
P 253



VOX
P 254



TAMA
P 255



REMO
P 255



WEDGEG
P 256



NED
P 257

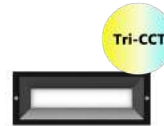

BRICKTRI
P 258-259

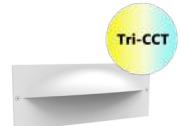

OGA
P 260



BULK1-2
P 261



BULK3
P 262



BULK5
P 262



BULK7
P 262



BULK9-10
P 263



BULK11-14
P 264



BULK15-18
P 265



CLA4736CB
P 266



OYSDIM001-002
P 267



ULAN
P 268



DOCCIA
P 269



STE3-4
P 270



STE5-6
P 271



STE7-8
P 272



STE9-10
P 273



STE12 & 23
P 274



STE13-14
P 275



STE15-18
P 276



STE19-22
P 277



PDL Pillar Lights
P 278-279

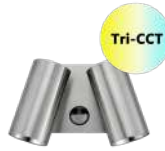

SEC05-10
P 280-282



Spot Pillar Lights
P 283



Pillar Lights
P 284-307



Bar Pillar Lights
P 293, 295, 297



BORDA
P 308



TORRE
P 309



PHARE
P 310-311



ELANORA
P 312



PORTUS
P 313



SHU
P 314



GEB
P 315



AMUN
P 316



HATHOR
P 317



SETH
P 318



HORUS
P 319

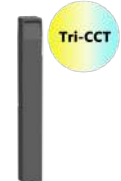

TOREN
P 320



SEKER
P 321



BOL
P 322



COOLIE
P 323



SPMS
P 324



SPM1A/2A
P 325



PHARE Spike Lights
P 326



KOLEC
P 327



KAM
P 327



Pond Light
P 328



DECK
P 329



Inground Up Lights
P 330-333



SMTFLOOD
P 334



SEC11S
P 335



TABLET
P 336



FLOOD15-16
P 336



FLOOD14 & 22
P 337



SHIELDTRI
P 338

General Downlights



TELE
P 340



TUBO
P 341



SMTNOVA
P 342



GALTRI
P 343



NOVADLUX
P 344-345



COMET01-04
P 346



COMET05-08
P 347



COSMOTRI
P 348



FIREFLY
P 349



NOVATRIS
P 350



MOTION
P 351



SLICKTRI
P 352



SHOPTRI01
P 353



SHOPTRI
P 354



SURFACE
P 355-356

General ___
Interior Spot Lights



SPOT
P 358-359

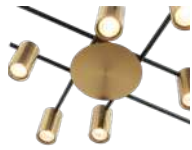

TACHE
P 360-364

General ___
Oyster Lights



SMTOYS
P 366



OYSDIM
P 367-368



SURFACETRI
P 369

General ___
Battens



BAT001-002
P 371



RAZOR
P 372



RAZOR (Wide)
P 373



SHIELDTRI
P 374

General ___
Connectable Track Systems



TRKTRI
P 376-377



GU10 Track Heads
P 378



Accessories
P 379-391

General Interior Utility Lights

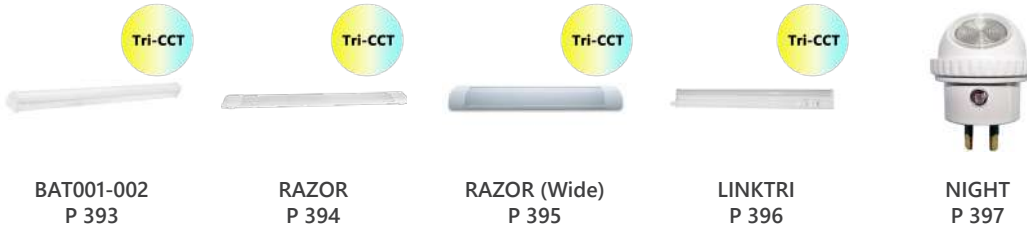

BAT001-002
P 393

RAZOR
P 394

RAZOR (Wide)
P 395

LINKTRI
P 396

NIGHT
P 397

General High Bays & Security Lights



HIBTRI
P 399

SEC01-02
P 401

SEC03-04
P 402

SEC05-10
P 403-405

SEC11S
P 406

Globes LED Globes



SMTGU10
P 408

GU10TRI
P 409

GU10
P 409

GU10 Dimmable
P 410

GU10 RGB
P 410

MR16TRI
P 411

MR16
P 411

MR16 RGB
P 412

MR11
P 412

SMTGLS
P 413

GLSTRI
P 414

GLS Filament
P 414-415



GLS Filament
P 415



GLS
P 416-417



FR Filament
P 418



FR Filament
P 418-419



FR
P 419



Candle Filament
P 420



Candle Filament
P 420-421



Candle
P 419



T40
P 422-423



G95 Filament
P 423



G95 Filament
P 424



G95
P 424-425



G125 Filament
P 425



G125 Filament
P 426



G125 Filament
P 426



G125 Filament
P 427



Pear Filament
P 428



ST57 Filament
P 428



PAR38
P 429



PAR30
P 430



R63 & R80
P 430



PILOT
P 431



T30 Filament
P 431



R7S
P 432



R7
P 432



SPECTRA
P 433



CHAMA
P 434



BUG
P 434



3U
P 435



GX53
P 435



G4 Bi-Pin
P 436



G4 Bi-Pin
P 436



G9
P 437



PLC
P 438



ELLIP
P 439



PT8
P 440-441



CKTRI
P 442

Globes ___ Fluorescent Globes



2D FL
P 444



T5 FL
P 444



T9 FL
P 445



PL DU FL
P 445



PL DUE FL
P 446

Globes ___ Carbon Filament Globes



G95
P 448



G125
P 448



ST57
P 449



T45
P 449



T9
P 450

Globes ___ Heat Lamp Globes



CLAHL
P 452

Accessories

Electrical Accessories



CLUSTER
P 454



LYNX
P 455



VELA
P 456



SENS001-002
P 457



SENS003
P 458



SENS004
P 459



SENS005
P 460

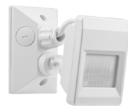

SENS007-008
P 461



SENS009-010
P 462



SENS011
P 463



CONN003-004
P 464



CONN005-007
P 465



SOCK
P 466



GPO
P 467



BATFIX
P 467



SADDLE
P 468



Flex & Plug
P 469



Lamp Holder
P 469



PLUG
P 470



LEAD
P 470



Power Board
P 471

Accessories

Control Gear



OTTER IP67
P 473



12V Drivers IP67
P 474



24V Drivers IP67
P 474



DRIV IP20
P 475



12V Driver IP20
P 475



Transformer IP20
P 476

Accessories

Team Brand Products



Tyre Pump
P 478



Jump Start Charger
P 478-481



LED Load Resistor
P 481



Auto Globes
P 482-484



Rags
P 485



Synthetic Chamois
Cloth P 486



Drying Towel
P 486



Headlight Resto-
ration Kit P 487



Window Repair Kit
P 487



Head Light Torch
P 488



COUGAR
P 489



GRAB-AND-GO
P 489



LED65WKL
P 489



BIG SLIM
P 490



SLIM BENDY
P 491



ROCKY
P 491



LITTLEKRAKKA
P 492



EXELRIPPA
P 492



LED41WKL
P 493



TOE2530PRO
P 493



EX-288
P 493



EX-10812V
P 494



EX-108
P 494

ATTENTION:

The pendant lights are hand made items, so the colour and shape of each piece may vary slightly. Please check that you are happy with the quality and finish of these products BEFORE INSTALLATION. CLA LIGHTING offer a replacement warranty only. Installation costs will not be borne by CLA Lighting.

All products comply with "all Australian and NZ Standards"

All images and information in this publication are current at the time of print and are to be used as a guide only. Please refer to our website www.clalighting.com.au prior to purchase for updates since the print of this publication or email us at sales@clalighting.com.au or call our Sydney office on (02) 9938 7100.



DECOR LIGHTING

Interior Pendant Lights

This is a hand made item, so the colour and shape of each piece may vary slightly. Actual colours may vary. This is due to the fact that every computer monitor has a different capability to display colours and that everyone sees these colours differently. We try to edit our photos to show the samples as life-like as possible, but please understand the actual colour may vary slightly from your monitor. We cannot guarantee that the colour you see accurately portrays the true colour of the product. Please check that you are happy with the quality and finish of this product BEFORE INSTALLATION.



Clessidra Interior Pendant Lights



CLESSIDRA3
(12XE27)



CLESSIDRA1
(1XE27)



CLESSIDRA1X3R
(3XE27)

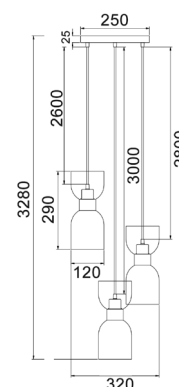
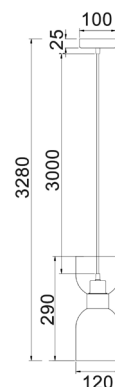
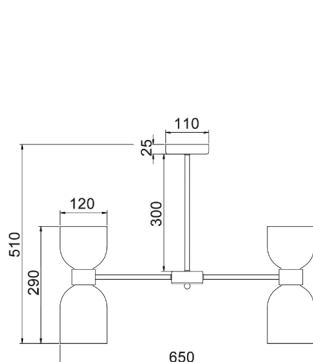

- Interior ellipse smokey black mirror finished glass pendant lights
- Material: glass & iron
- Globe not included
- For indoor use only



Part No.	CLESSIDRA1, CLESSIDRA1X3R, CLESSIDRA3
Description	PENDANT Smokey Black Mirror Finished Glass Ellipse
Material	Iron & glass
Lamp holder	E27 (Max.72W)
Product Dimensions	Please see the line drawing
Suspension	CLESSIDRA1: 3000mm cable CLESSIDRA1X3R: 2600/ 2800/ 3000mm cable CLESSIDRA3: 300mm Rod
Canopy size	CLESSIDRA1: Ø100x25mm CLESSIDRA1X3R: Ø250x25mm CLESSIDRA3: Ø110x25mm
Carton QTY	1/1



CLESSIDRA4
(12XE27)



CLESSIDRA2
(1XE27)



CLESSIDRA2X3R
(3XE27)

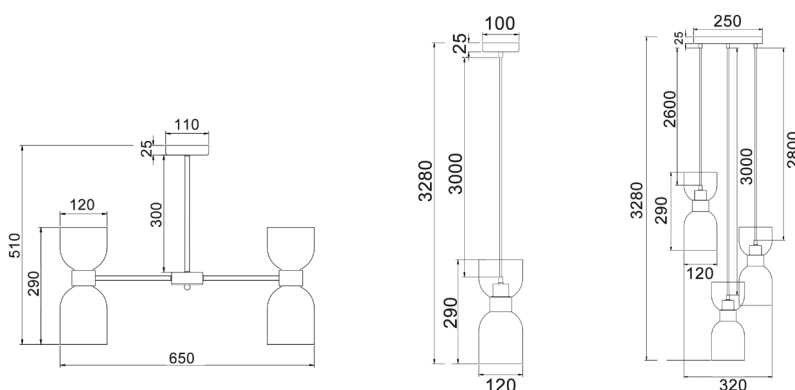

- Interior ellipse opal glass pendant lights
- Material: glass & iron
- Globe not included
- For indoor use only



CLESSIDRA Interior wall lights are also available

Part No.	CLESSIDRA2, CLESSIDRA2X3R, CLESSIDRA4
Description	PENDANT Opal Glass Ellipse
Material	Iron & glass
Lamp holder	E27 (Max.72W)
Product Dimensions	Please see the line drawing
Suspension	CLESSIDRA2: 3000mm cable CLESSIDRA2X3R: 2600/ 2800/ 3000mm cable CLESSIDRA4: 300mm Rod
Canopy size	CLESSIDRA2: Ø100x25mm CLESSIDRA2X3R: Ø250x25mm CLESSIDRA4: Ø110x25mm
Carton QTY	1/1



Manga Interior Pendant Lights



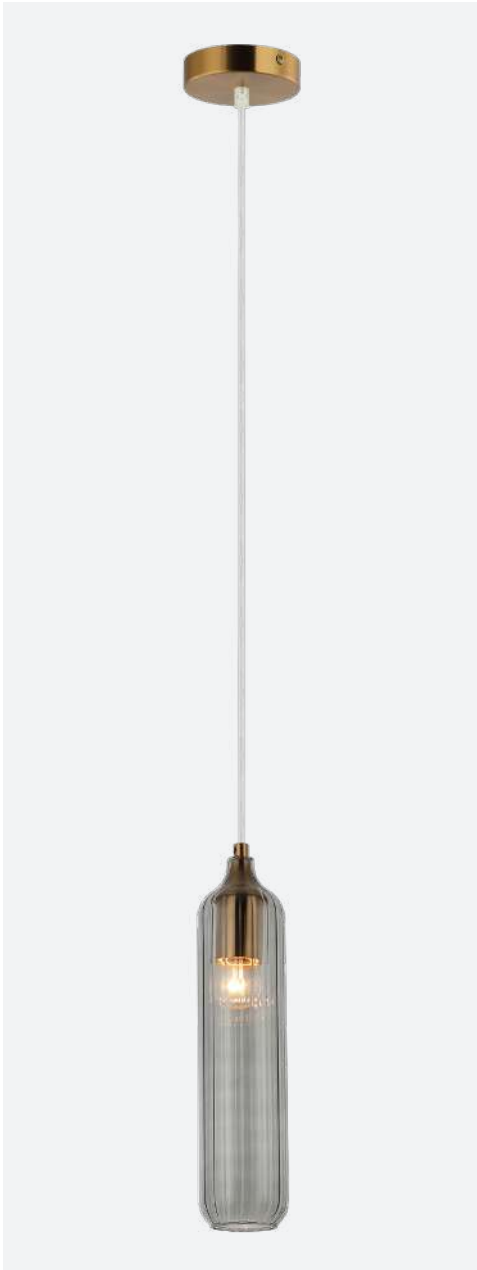

MANGA1
(Smokey Black)



MANGA2
(Green)

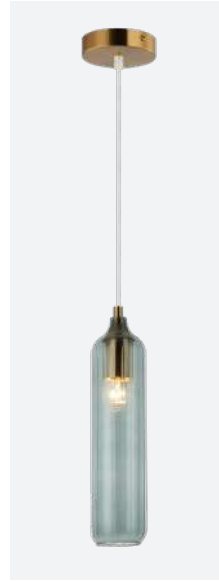

MANGA3
(Blue)



MANGA4
(Amber)



MANGA5
(Clear)

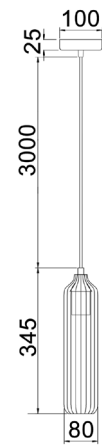

- Interior glass cylinder pendant light
- Material: glass
- Globe not included
- For indoor use only



Part No.	MANGA1-5
Description	PENDANT ES Glass Cylinder OD80mm
Material	Glass
Lamp holder	1xE27 (Max.72W)
Dimensions	Ø80 x H345mm
Suspension	3000mm clear cable
Canopy size	Ø100 x H25mm
Carton QTY	1/10

Banquet Interior Pendant Lights

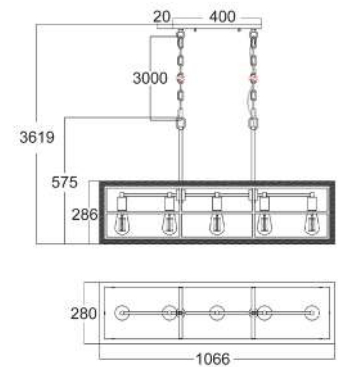

BANQUET1

- Interior rectangular wood frame pendant light
- Material: wood & iron
- Globe not included
- For indoor use only



Part No.	BANQUET1
Description	PENDANT ES 5 x 60W Rect Frame Medium Oak Wood With Oil Rubbed Bronze Hardware
Material	Wood & iron
Lamp holder	5xE27 (Max.60W)
Dimensions	L1066 x W280 x H286mm
Suspension	3000mm cable & chain + 289mm rod
Canopy size	L400 x W130 x H20mm
Carton QTY	1/1



Virun Interior Pendant Lights

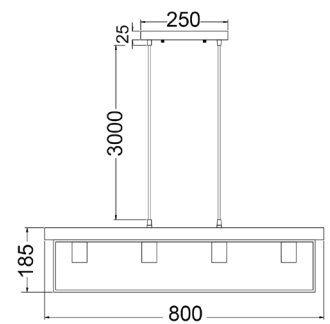

VIRUN1

- Interior rectangular wood frame pendant light
- Material: wood & iron
- Globe not included
- For indoor use only



Part No.	VIRUN1
Description	PENDANT ES 4 x 72W Rectangular Natural wood & iron
Material	Wood & iron
Lamp holder	4xE27 (Max.72W)
Dimensions	L800 x W150 x H185mm
Suspension	3000mm black cable
Canopy size	L250 x W50 x H25mm
Carton QTY	1/1



Barrique Interior Pendant Lights



BARRIQUE1
(Medium Oak Wood with Satin Brass Hardware)



BARRIQUE2
(Natural Wood with Oil Rubbed Bronze Hardware)

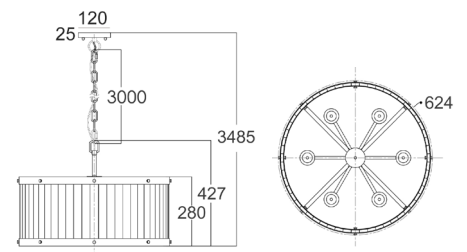

- Interior drum wood pendant lights
- Material: wood & iron
- Globe not included
- For indoor use only



Part No.	BARRIQUE1-2
Description	PENDANT ES 6 x 60W Large Drum Wood With hardware
Material	wood
Lamp holder	6xE27 (Max.60W)
Dimensions	Ø624 x H427mm
Suspension	3000mm cable & chain
Canopy size	Ø120 x H25mm
Carton QTY	1/1



Votif Interior Pendant Lights

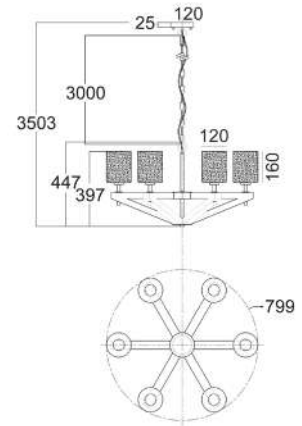

VOTIF1

- Interior candelabra wood pendant light
- Material: wood, iron & glass
- Globe not included
- For indoor use only



Part No.	VOTIF1
Description	PENDANT ES 6 x 60W Candelabra Oak Wood Oil Rubbed Bronze Hardware & Clear blown Glass
Material	Wood, iron & glass
Lamp holder	6xE27 (Max.60W)
Dimensions	Ø799 x H447mm
Suspension	3000mm cable & chain
Canopy size	Ø120x 25mm
Carton QTY	1/1



Diablo Interior Pendant Lights



DIABLO1
(Black)

- Interior cone flat top pendant light
- Material: iron
- Globe not included
- For indoor use only



Part No.	DIABLO1-2
Description	PENDANT ES Cone Flat Top
Material	Iron
Lamp holder	1xE27 (Max.72W)
Dimensions	Ø250 x H235mm
Suspension	3000mm cable
Canopy size	Ø100 x 25mm
Carton QTY	1/1



DIABLO2
(White)



Maraca Interior Pendant Lights



MARACA1
(Smokey Glass & Antique Brass Highlight)



MARACA2
(Green Glass & Black Highlight)



MARACA3
(Amber Glass & Black Highlight)

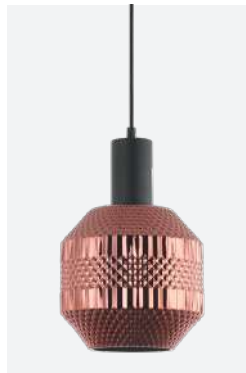

MARACA4
(Copper Glass & Black Highlight)

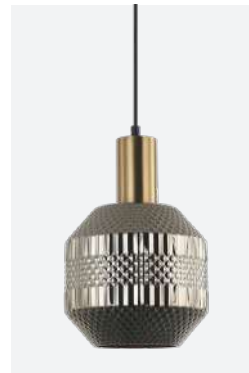

MARACA5
(Matte Gold Glass & Antique Brass Highlight)

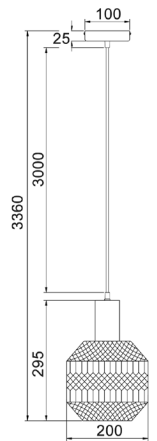

- Interior wine glass quadrilateral segment pendant lights
- Material: glass
- Globe not included
- For indoor use only



Part No.	MARACA1-5
Description	PENDANT ES 72W Wine Glass with Quadrilateral Segment & Highlight
Material	Glass
Lamp Holder	1xE27 (Max.72W)
Dimensions	Ø200 x H295mm
Suspension	3000mm black cable
Canopy Size	Ø100 x 25mm
Carton QTY	1/1



Brote Interior Pendant Lights



BROTE1
(Amber Glass & Bronze Highlight)

- Interior wine glass shape pendant lights
- Material: glass
- Globe not included
- For indoor use only



Part No.	BROTE1-2
Description	PENDANT ES 72W Wine Glass
Material	Glass
Lamp Holder	1xE27 (Max.72W)
Dimensions	Ø180 x H350mm
Suspension	3000mm PVC cable
Canopy Size	Ø100 x 25mm
Carton QTY	1/1



BROTE2
(Smoky Black Mirror Finished Glass & Black Highlight)

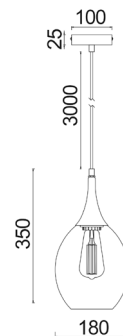

Pelota Interior Pendant Lights





PELOTA1
(Smokey Black)



PELOTA2
(Green)

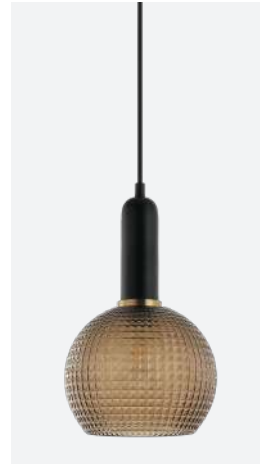

PELOTA3
(Amber)

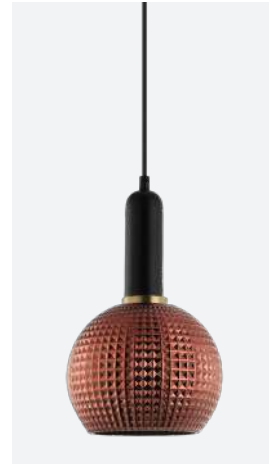

PELOTA4
(Copper Painted)



PELOTA5
(Chrome)



PELOTA6
(Clear)

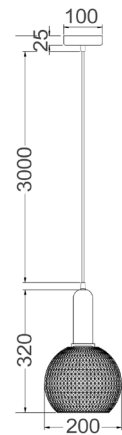

- Interior wine glass segmented glass pendant lights
- Material: glass
- Globe not included
- For indoor use only



Part No.	PELOTA1-6
Description	PENDANT ES Wine Glass Segmented Glass
Material	Glass
Lamp holder	1xE27 (Max.72W)
Dimensions	Ø200 x H320mm
Suspension	3000mm black cable
Canopy size	Ø100 x 25mm
Carton QTY	1/1

Vintaj Interior Pendant Lights





VINTAJ1
(Smokey Black)



VINTAJ2
(Green)

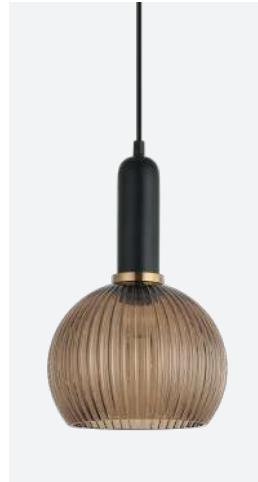

VINTAJ3
(Amber)



VINTAJ4
(Copper Painted)



VINTAJ5
(Chrome)



VINTAJ6
(Clear)

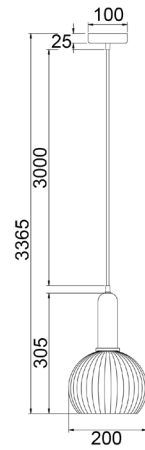

- Interior wine glass ribbed glass pendant lights
- Material: glass
- Globe not included
- For indoor use only



Part No.	VINTAJ1-6
Description	PENDANT ES Wine Glass Ribbed Glass with Brass
Material	Glass
Lamp holder	1xE27 (Max.72W)
Dimensions	Ø200 x H305mm
Suspension	3000mm black cable
Canopy size	Ø100 x 25mm
Carton QTY	1/1



DECOR LIGHTING



VINTAJ7
(Smokey black)



VINTAJ8
(Green)



VINTAJ9
(Amber)



VINTAJ10
(Copper Painted)



VINTAJ11
(Chrome)



VINTAJ12
(Clear)

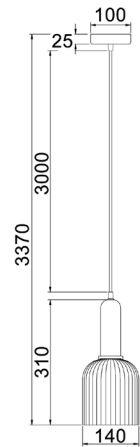

- Interior ellipse ribbed glass pendant lights
- Material: glass
- Globe not included
- For indoor use only



Part No.	VINTAJ7-12
Description	PENDANT ES Ellipse Ribbed Glass with Brass
Material	Glass
Lamp holder	1xE27 (Max.72W)
Dimensions	Ø140 x H310mm
Suspension	3000mm black cable
Canopy size	Ø100 x 25mm
Carton QTY	1/1



VINTAJ13
(Smokey black)



VINTAJ14
(Green)



VINTAJ15
(Amber)



VINTAJ16
(Copper Painted)



VINTAJ17
(Chrome)



VINTAJ18
(Clear)

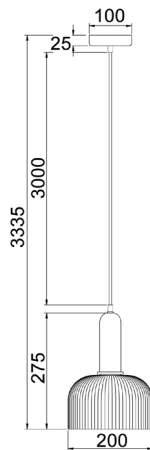

- Interior dome ribbed glass pendant lights
- Material: glass
- Globe not included
- For indoor use only



Part No.	VINTAJ13-18
Description	PENDANT ES Dome Ribbed Glass with Brass
Material	Glass
Lamp holder	1xE27 (Max.72W)
Dimensions	Ø200 x H275mm
Suspension	3000mm black cable
Canopy size	Ø100 x 25mm
Carton QTY	1/1

Marbre Interior Pendant Lights



MARBRE1
(Smokey Black)



MARBRE2
(Green)



MARBRE3
(Amber)

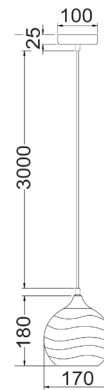

- Interior wine glass shape pendant lights
- Material: glass
- Globe not included
- For indoor use only



Part No.	MARBRE1-3
Description	PENDANT ES Wine Glass Wavy Glass
Material	Glass
Lamp Holder	1xE27 (Max.72W)
Dimensions	Ø170 x H180mm
Suspension	3000mm black cable
Canopy Size	Ø100 x 25mm
Carton QTY	1/1



Golpe Interior Pendant Lights



GOLPE1 - Black / Small
GOLPE3 - Black / Large



GOLPE2 - Champagne Gold / Small
GOLPE4 - Champagne Gold / Large

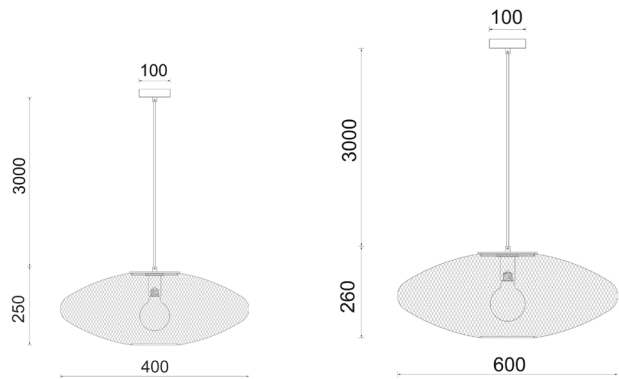

- Interior oval stainless steel pendant lights
- Material: stainless steel
- Globe not included
- For indoor use only



Part No.	GOLPE1-4
Description	PENDANT ES 60W Oval Black / Champagne Gold Small / Large Stainless Steel
Material	Stainless steel
Lamp Holder	1xE27 (Max.60W)
Dimensions	GOLPE1-2: Ø400 x H250mm GOLPE3-4: Ø600 x H260mm
Suspension	3000mm PVC black cable
Canopy Size	Ø100mm
Carton QTY	1/1



Cerema Interior Pendant Lights



CEREMA1
(Ellipse)



CEREMA2
(Angled dome)



CEREMA3
(Coolie)



CEREMA4
(Small Coolie)

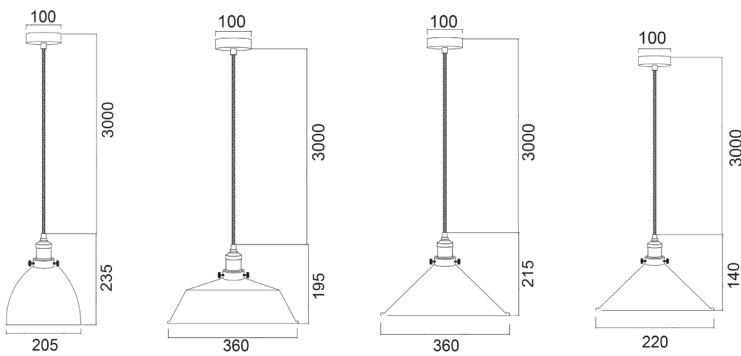

- Interior white with antique brass and black highlight pendant lights
- Material: bamboo
- Globe not included
- For indoor use only



Part No.	CEREMA1-4
Description	PENDANT ES 40W White With Antique Brass & Black Highlight
Material	Metal
Lamp holder	1xE27 (Max.40W)
Dimensions	CEREMA1: Ø205 x H235mm CEREMA2: Ø360 x H195mm CEREMA3: Ø360 x H215mm CEREMA4: Ø220 x H140mm
Suspension	3000mm white cable
Canopy size	Ø100mm
Carton QTY	1/1



Sari Interior Pendant Lights



SARI1
(Aged Brass Steel)



SARI12
(Chrome Steel)

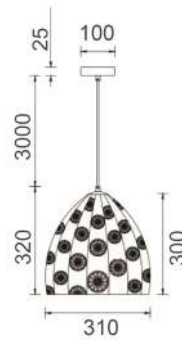

- Interior embossed ellipse pendant lights
- Material: metal
- Globe not included
- For indoor use only



Part No.	SARI1-2
Description	PENDANT ES 60W Embossed Ellipse
Material	Metal
Lamp holder	1xE27 (Max.60W)
Dimensions	Ø310 x H320mm
Suspension	3000mm black cable
Canopy size	Ø100 x H25mm
Carton QTY	1/1



Canamo Interior Pendant Lights

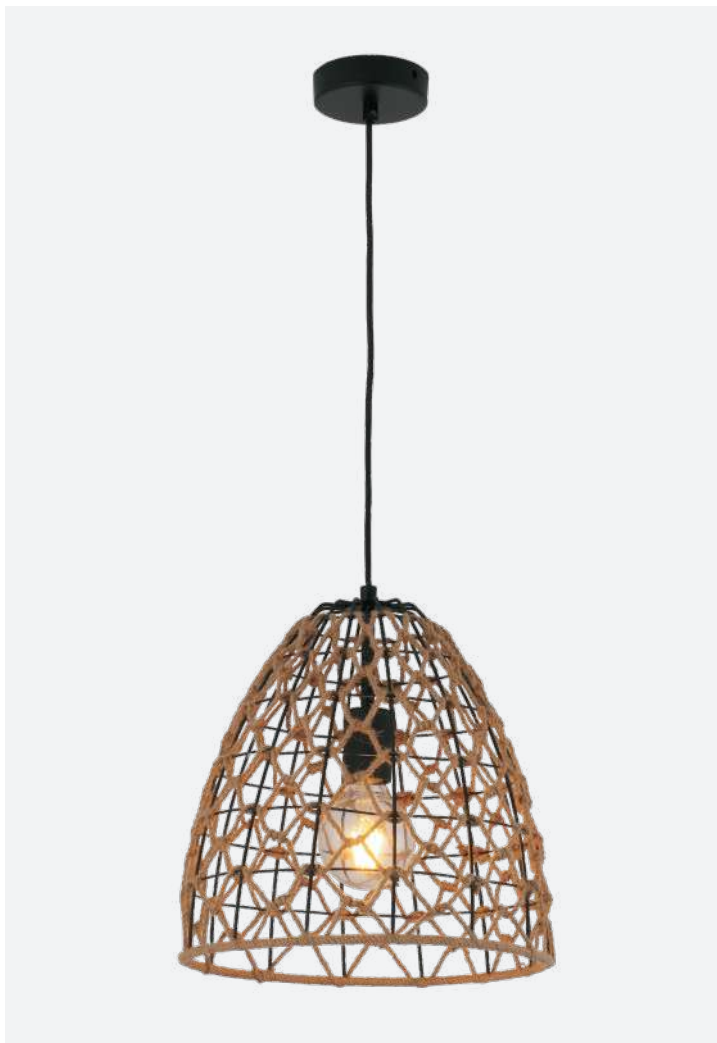

CANAMO1
(Ellipse Shape)

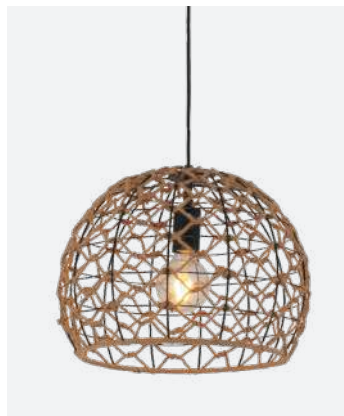

CANAMO2
(Wine Glass Shape)

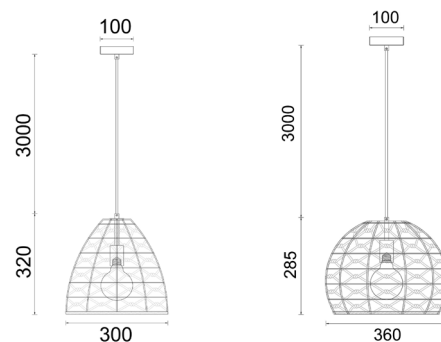

- Interior hemp rope pendant lights
- Material: steel and hemp rope
- Globe not included
- For indoor use only



Part No.	CANAMO1-2
Description	PENDANT ES 40W Natural Hemp Rope & Black Hardware
Material	Steel & Hemp rope
Lamp holder	1xE27 (Max.40W)
Dimensions	CANAMO1: Ø300 x H320mm CANAMO2: Ø360 x H285mm
Suspension	3000mm black cable
Canopy size	Ø100mm
Carton QTY	1/1



Coup Interior Pendant Lights



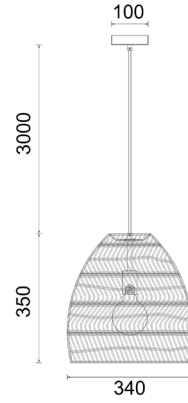

COUP1

- Interior rattan ellipse pendant lights
- Material: rattan
- Globe not included
- For indoor use only



Part No.	COUP1
Description	PENDANT ES 60W Rattan Ellipse Matte Black
Material	Rattan
Lamp holder	1xE27 (Max.40W)
Dimensions	Ø340 x H350mm
Suspension	3000mm black cable
Canopy size	Ø100mm
Carton QTY	1/1



Rota Interior Pendant Lights

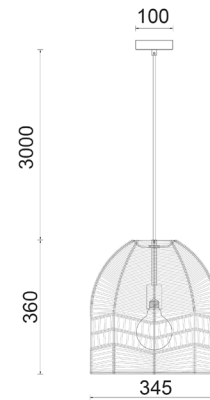

ROTA1

- Interior rattan ellipse pendant light
- Material: rattan
- Globe not included
- For indoor use only



Part No.	ROTA1
Description	PENDANT ES 40W Natural Rattan Ellipse White
Material	Rattan
Lamp holder	1xE27 (Max.40W)
Dimensions	Ø345 x H360mm
Suspension	3000mm white cable
Canopy size	Ø100mm
Carton QTY	1/1



Cesta Interior Pendant Lights



CESTA1



- Interior cylinder brown/natural bamboo cage pendant light
- Material: bamboo
- Globe not included
- For indoor use only



Part No.	CESTA1
Description	PENDANT ES 40W Cylinder Natural / Brown Bamboo Cage With Black High-light & Cable
Material	Bamboo
Lamp holder	1xE27 (Max.40W)
Dimensions	Ø250 x H360mm
Suspension	3000mm black cable
Canopy size	Ø100mm
Carton QTY	1/1

DECOR LIGHTING

Canasta Interior Pendant Lights

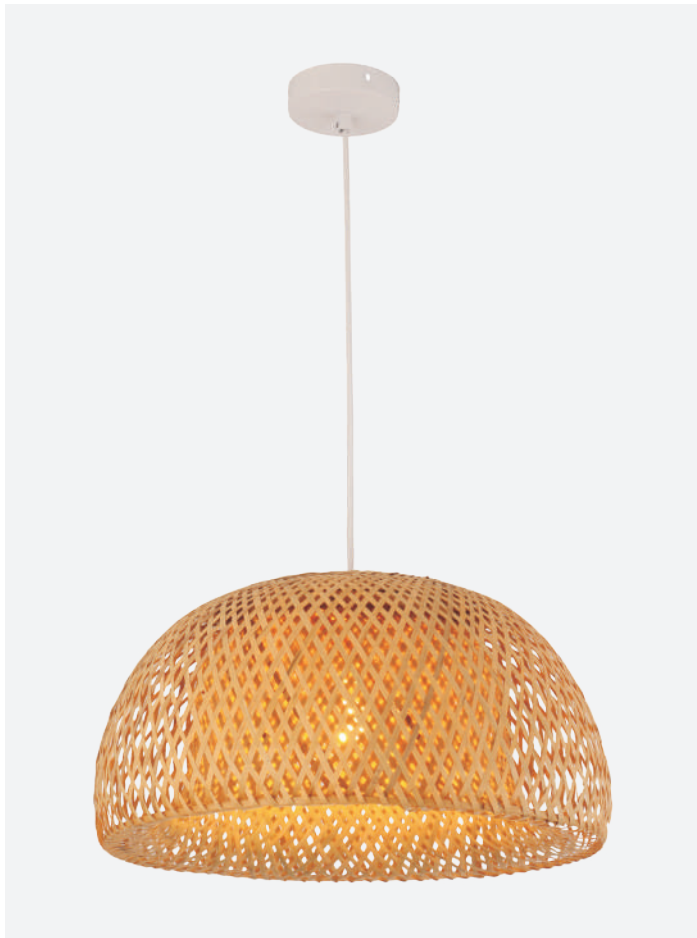

CANASTA1 - Small
CANASTA2 - Large

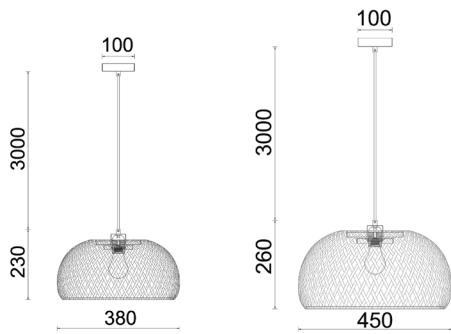

- Interior bamboo finish pendant lights
- Material: bamboo
- Globe not included
- For indoor use only



Part No.	CANASTA1-2
Description	Pendant ES 40W Small/ Large Natural Bamboo Finish
Material	Bamboo
Lamp holder	1xE27 (Max.40W)
Dimensions	CANASTA1: Ø380 x H230mm CANASTA2: Ø450 x H260mm
Suspension	3000mm white cable
Canopy size	Ø100mm
Carton QTY	1/1

Origami Interior Pendant Lights

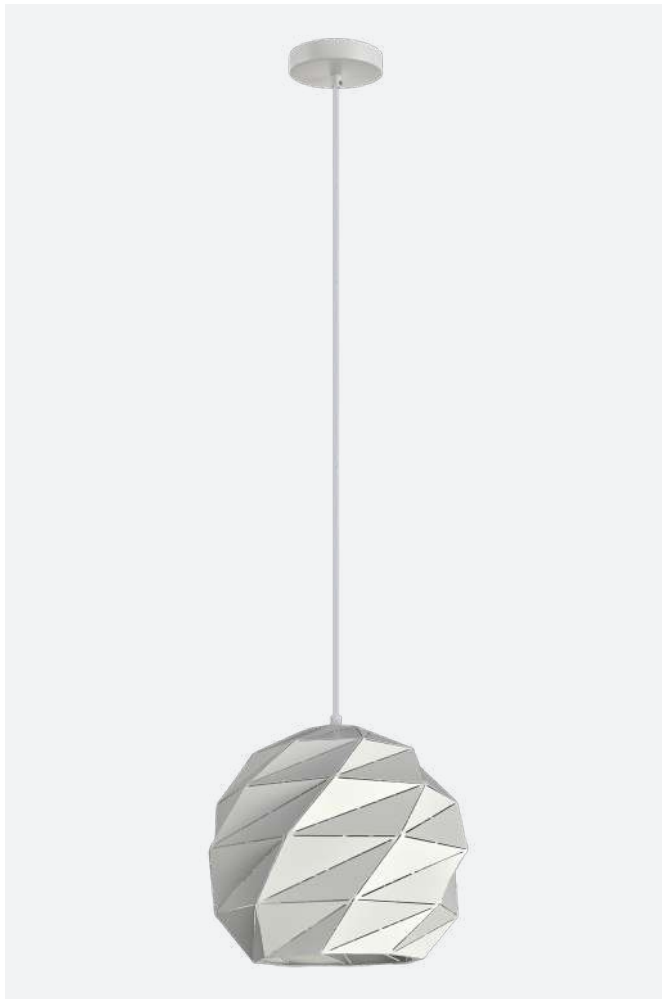

ORIGAMI1 - Small
ORIGAMI4 - Large
 (White & White Interior)

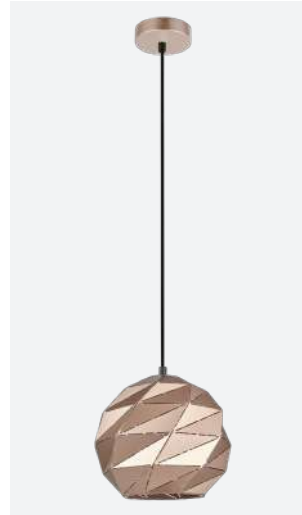

ORIGAMI2 - Small
ORIGAMI5 - Large
 (Rose Gold & Gold Interior)



ORIGAMI3 - Small
ORIGAMI6 - Large
 (Matte Grey & Gold Interior)

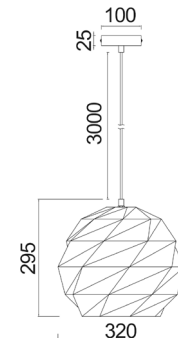
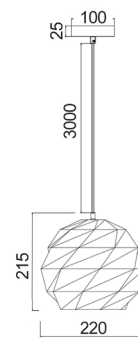

- Interior iron wine glass triangular tiled pendant lights
- Material: iron
- Globe not included
- For indoor use only



Part No.	ORIGAMI1-6
Description	PENDANT ES 72W SML/ LRG Wine Glass Triangular Tiled Iron
Material	Iron
Lamp holder	1xE27 (Max.72W)
Dimensions	ORIGAMI1-3: Ø220 x H215mm ORIGAMI4-6: Ø320 x H295mm
Suspension	3000mm PVC cable
Canopy size	Ø100 x 25mm
Carton QTY	1/1



Tuile Interior Pendant Lights

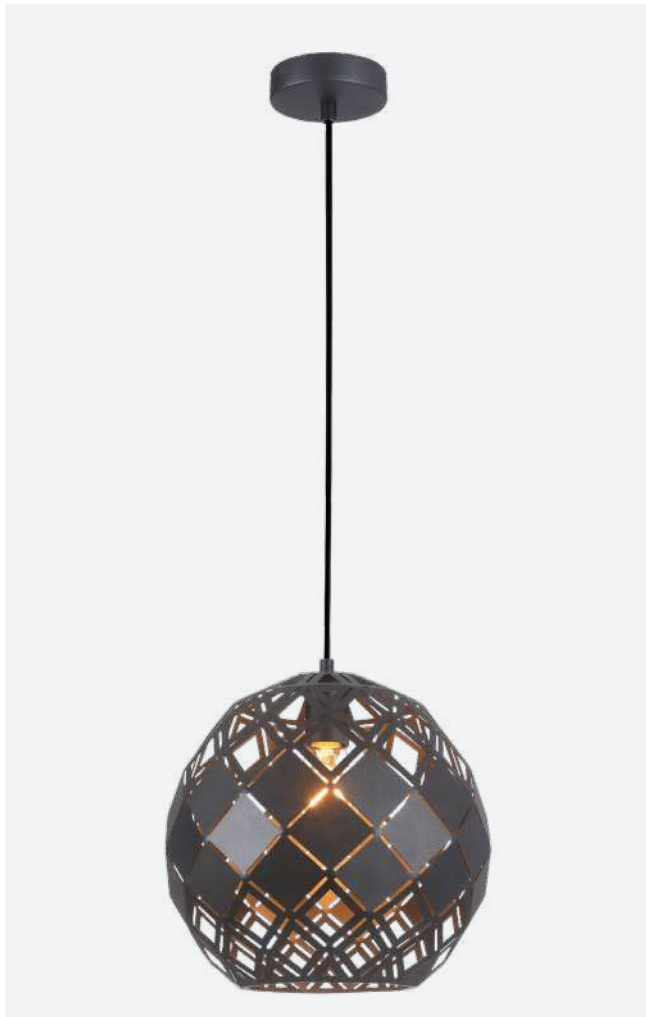

TUILE1 - Small
TUILE4 - Large
(Matte Black)

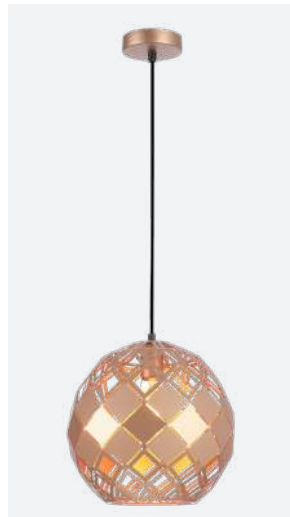

TUILE2 - Small
TUILE5 - Large
(Champagne Gold)

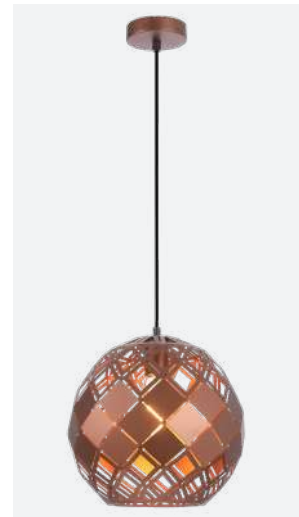

TUILE3 - Small
TUILE6 - Large
(Coffee)

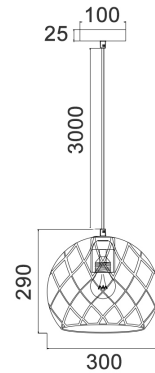
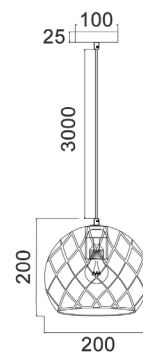

- Interior iron wine glass perforated(Diamond) tiles pendant lights
- Material: iron
- Globe not included
- For indoor use only



Part No.	TUILE1-6
Description	PENDANT ES 72W Wine Glass Perforated (Diamond) Tiles
Material	Iron
Lamp Holder	1xE27 (Max.72W)
Dimensions	TUILE1-3: Ø200 x H200mm TUILE4-6: Ø300 x H290mm
Suspension	3000mm PVC black cable
Canopy Size	Ø100 x 25mm
Carton QTY	1/1

*Product images have a warm white light source 'on'



Botanica Interior Pendant Lights



BOTANICA01A
(White)



BOTANICA02A
(Black)

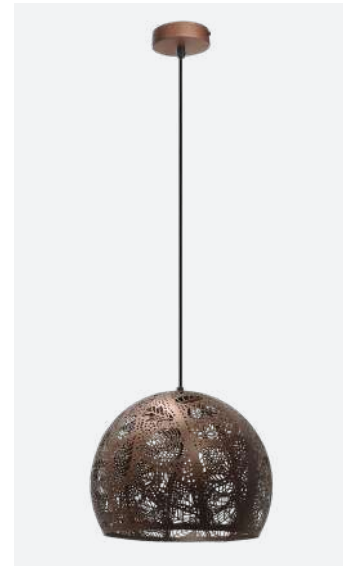

BOTANICA03A
(Coffee)

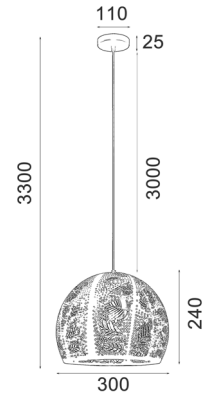

- Interior iron dome perforated (Leaves) pendant lights
- Material: iron
- Globe not included
- For indoor use only



Part No.	BOTANICA01A-03A
Description	PENDANT ES 72W Dome Perforated (Leaves)
Material	Iron
Lamp Holder	1xE27 (Max.72W)
Dimensions	Ø300 x H240mm
Suspension	3000mm PVC cable
Canopy Size	Ø110 x 25mm
Carton QTY	1/1



Marrakesh Interior Pendant Lights



MARRAKESH01
(Margarita Glass Shape)



MARRAKESH02
(Tear Drop Shape)



MARRAKESH03A
(Dome Shape)



MARRAKESH04
(Margarita Glass Shape)



MARRAKESH05
(Bottle Shape)

- Interior black iron pendant lights
- Material: iron
- Shade interior colour: gold
- Globe not included
- For indoor use only



Part No.	MARRAKESH01-05
Description	PENDANT ES 72W Perforated (Morrocan) Black with Gold Interior
Material	Iron
Lamp Holder	1xE27 (Max.72W)
Dimensions	MARRAKESH01: Ø300 x H390mm MARRAKESH02: Ø300 x H280mm MARRAKESH03A: Ø400 x H200mm MARRAKESH04: Ø250 x H175mm MARRAKESH05: Ø160 x H510mm
Suspension	3000mm PVC black cable
Canopy Size	Ø110 x 25mm
Carton QTY	1/1

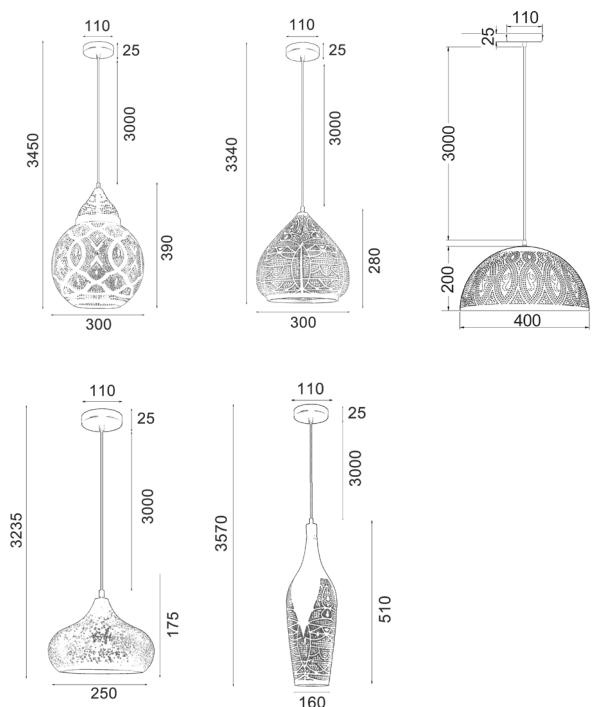

*Product images have a warm white light source 'on'

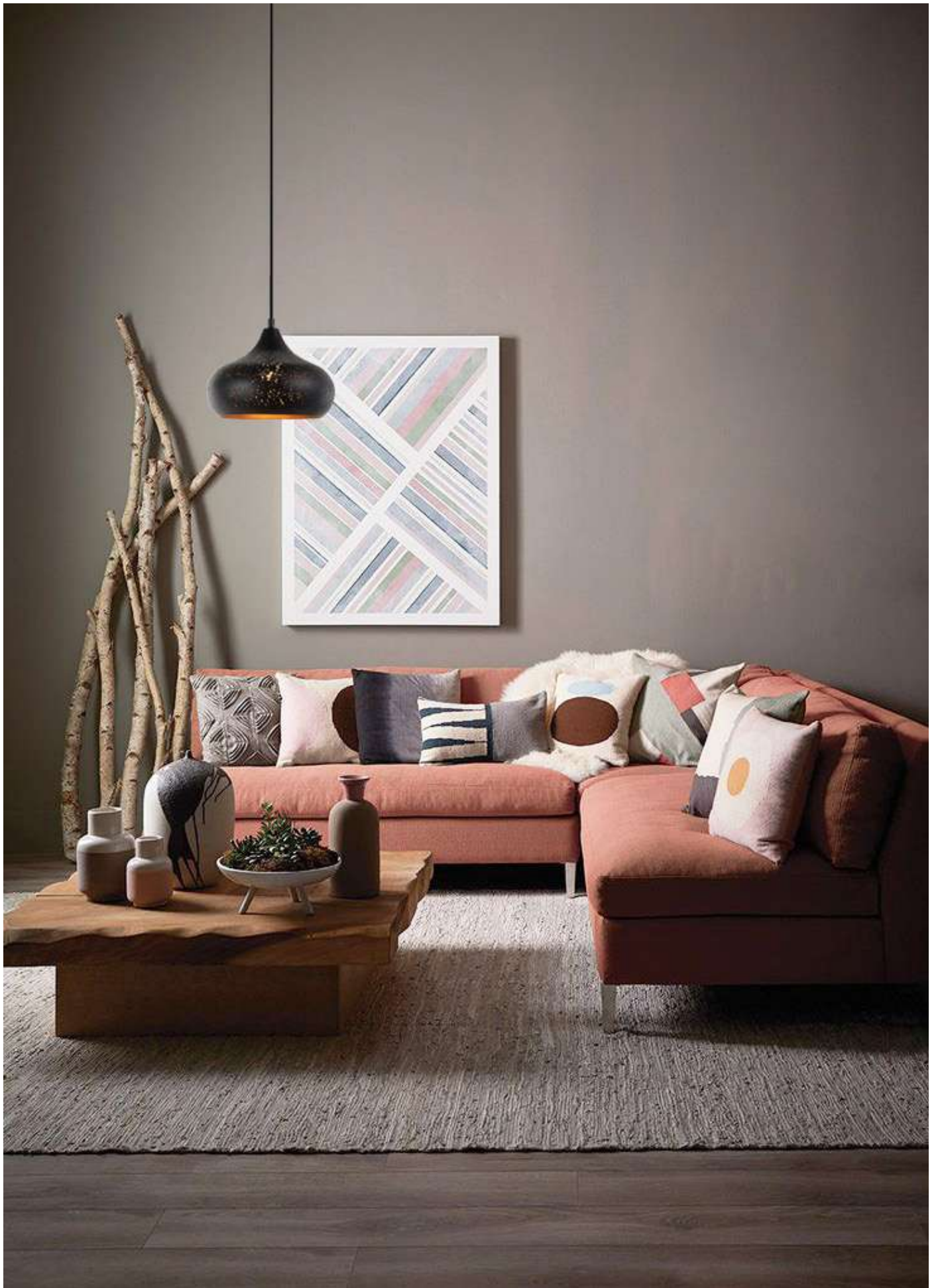



MARRAKESH06
(Margarita Glass Shape)



MARRAKESH07
(Tear Drop Shape)



MARRAKESH08
(Dome Shape)



MARRAKESH09
(Margarita Glass Shape)



MARRAKESH10
(Bottle Shape)

- Interior white iron pendant lights
- Material: iron
- Globe not included
- For indoor use only



Part No.	MARRAKESH06-10
Description	PENDANT ES 72W Perforated (Morrocan) White
Material	Iron
Lamp Holder	1xE27 (Max.72W)
Dimensions	MARRAKESH06: Ø300 x H390mm MARRAKESH07: Ø300 x H280mm MARRAKESH08: Ø400 x H200mm MARRAKESH09: Ø250 x H175mm MARRAKESH10: Ø160 x H510mm
Suspension	3000mm PVC white cable
Canopy Size	Ø110 x 25mm
Carton QTY	1/1

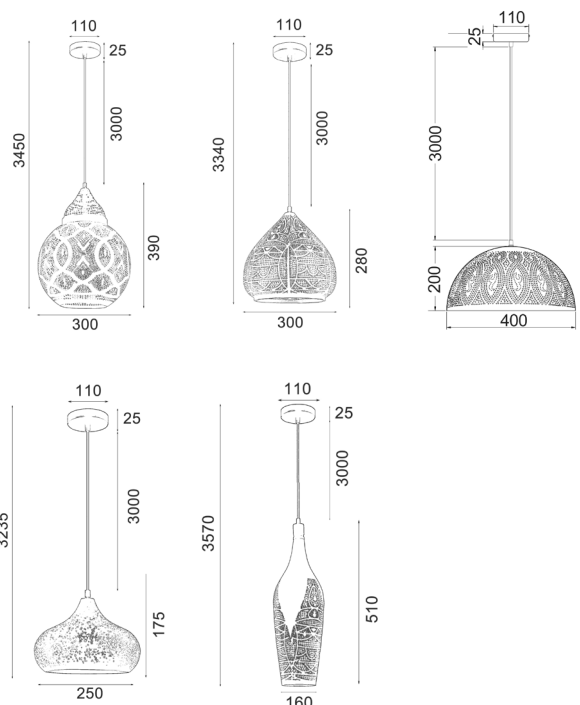



Patera Interior Pendant Lights



PATERA1
(Clear Glass)



PATERA2
(Smokey Black Glass)



PATERA3
(Amber Glass)

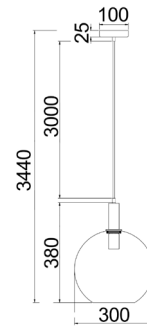

- Interior glass with extended bronze highlight pendant lights
- Material: iron & glass
- Globe not included
- For indoor use only



Part No.	PATERA1-3
Description	PENDANT ES 72W Wine Glass With Extended Bronze Highlight
Material	Iron & glass
Lamp Holder	1xE27 (Max.72W)
Dimensions	Ø300 x H380mm
Suspension	3000mm PVC cable
Canopy Size	Ø100 x 25mm
Carton QTY	1/1



Pesini Interior Pendant Lights



PESINI1
(Clear Glass/Antique Brass Highlight/Black Canopy)



PESINI4
(Clear Glass/Chrome Highlight/Chrome Canopy)



PESINI2
(Smokey Black Glass/Antique Brass Highlight/Black Canopy)



PESINI5
(Smokey Black Glass/Chrome Highlight/Chrome Canopy)



PESINI3
(Amber Glass/Antique Brass Highlight/Black Canopy)



PESINI6
(Amber Glass/Chrome Highlight/Chrome Canopy)

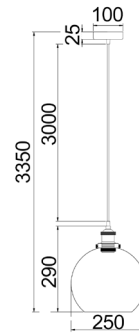

- Interior glass with antique brass / chrome highlight pendant lights
- Material: iron & glass
- Globe not included
- For indoor use only



Part No.	PESINI1-6
Description	PENDANT ES 72W Wine Glass With Antique Brass / Chrome Highlight
Material	Iron & glass
Lamp Holder	1xE27 (Max.72W)
Dimensions	Ø250 x H290mm
Suspension	3000mm PVC cable
Canopy Size	Ø100 x 25mm
Carton QTY	1/1



Pesini interior wall lights are also available

Vinum Interior Pendant Lights



VINUM1
(Chrome Glass)

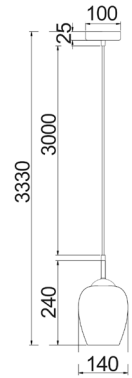

VINUM2
(Copper Coloured Glass)

- Interior wine glass shape with chrome highlight pendant lights
- Material: glass
- Globe not included
- For indoor use only



Part No.	VINUM1-2
Description	PENDANT ES 72W Wine Glass With Chrome Highlight
Material	Glass
Lamp Holder	1xE27 (Max.72W)
Dimensions	Ø140 x H240mm
Suspension	3000mm PVC cable
Canopy Size	Ø100 x 25mm
Carton QTY	1/1



Vinum interior wall lights are also available



Roche Interior Pendant Lights

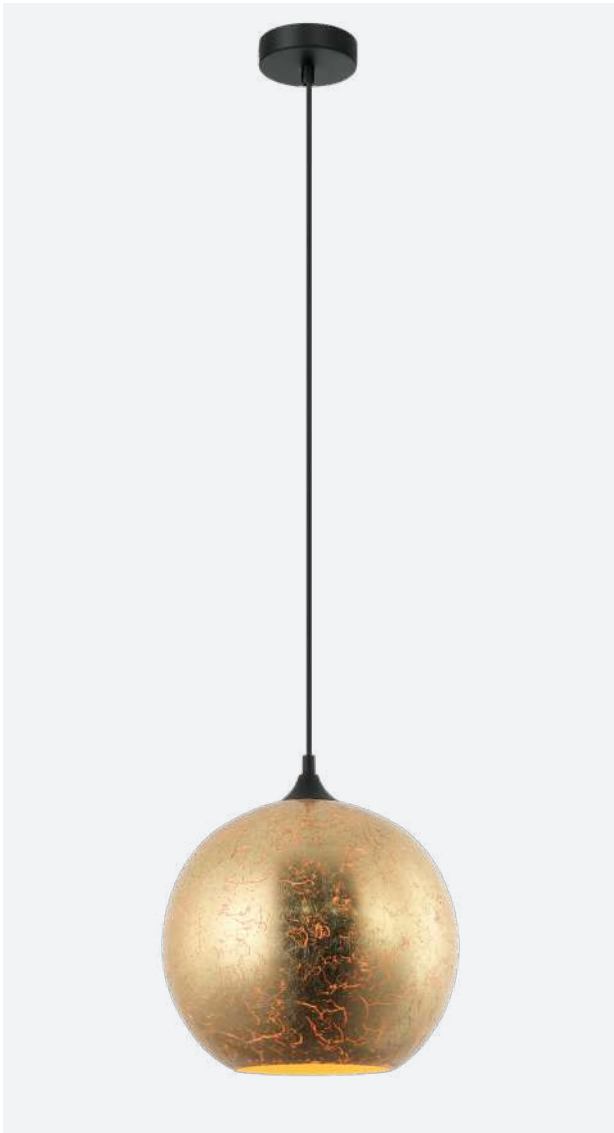

ROCHE1
(Crackled Matte Gold)

- Interior wine glass shape pendant lights
- Material: glass
- Shade interior colour: white
- Globe not included
- For indoor use only



Part No.	ROCHE1-2
Description	PENDANT ES 72W Wine Glass With White Interior
Material	Glass
Lamp Holder	1xE27 (Max.72W)
Dimensions	Ø300 x H310mm
Suspension	3000mm black cable
Canopy Size	Ø110 x 25mm
Carton QTY	1/1



ROCHE2
(Crackled Satin Chrome)

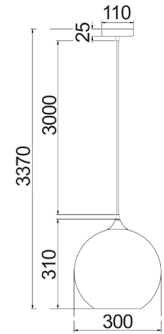

*Product images have a warm white light source 'on'

Jerez Interior Pendant Lights

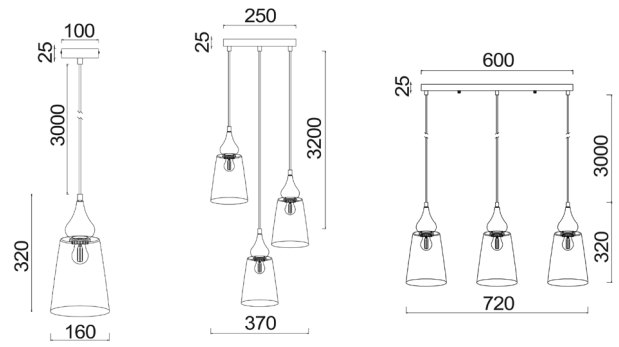

JEREZ1
(Amber Glass)



JEREZ1X3R
(Amber Glass)



JEREZ1X3S
(Amber Glass)

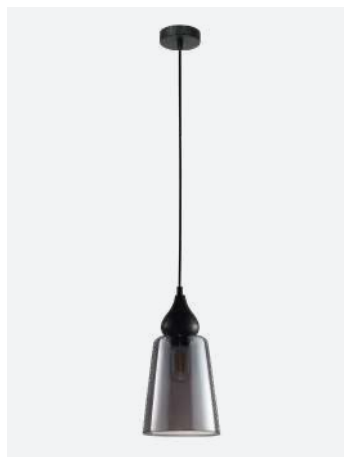

JEREZ2
(Smokey Black Glass)



JEREZ2X3R
(Smokey Black Glass)



JEREZ2X3S
(Smokey Black Glass)



- Interior glass flat top cone pendant lights
- Material: iron & glass
- Globe not included
- For indoor use only



Part No.	JEREZ1, JEREZ1X3R, JEREZ1X3S
Description	PENDANT ES 72W Glass Flat Top Cone
Material	Iron & glass
Lamp Holder	JEREZ1: 1xE27 (Max.72W) JEREZ1X3R: 3xE27 (Max.72W) JEREZ1X3S: 3xE27 (Max.72W)
Dimensions	JEREZ1: Ø160 x H320mm JEREZ1X3R: Ø370mm JEREZ1X3S: L720 x H320mm
Suspension	3000mm PVC cable
Canopy Size	JEREZ1: Ø100 x 25mm JEREZ1X3R: Ø250 x 25mm JEREZ1X3S: L600 x 25mm
Carton QTY	1/1

Part No.	JEREZ2, JEREZ2X3R, JEREZ2X3S
Description	PENDANT ES 72W Glass Flat Top Cone
Material	Iron & glass
Lamp Holder	JEREZ2: 1xE27 (Max.72W) JEREZ2X3R: 3xE27 (Max.72W) JEREZ2X3S: 3xE27 (Max.72W)
Dimensions	JEREZ2: Ø160 x H320mm JEREZ2X3R: Ø370mm JEREZ2X3S: L720 x H320mm
Suspension	3000mm PVC cable
Canopy Size	JEREZ2: Ø100 x 25mm JEREZ2X3R: Ø250 x 25mm JEREZ2X3S: L600 x 25mm
Carton QTY	1/1

Champan Interior Pendant Lights

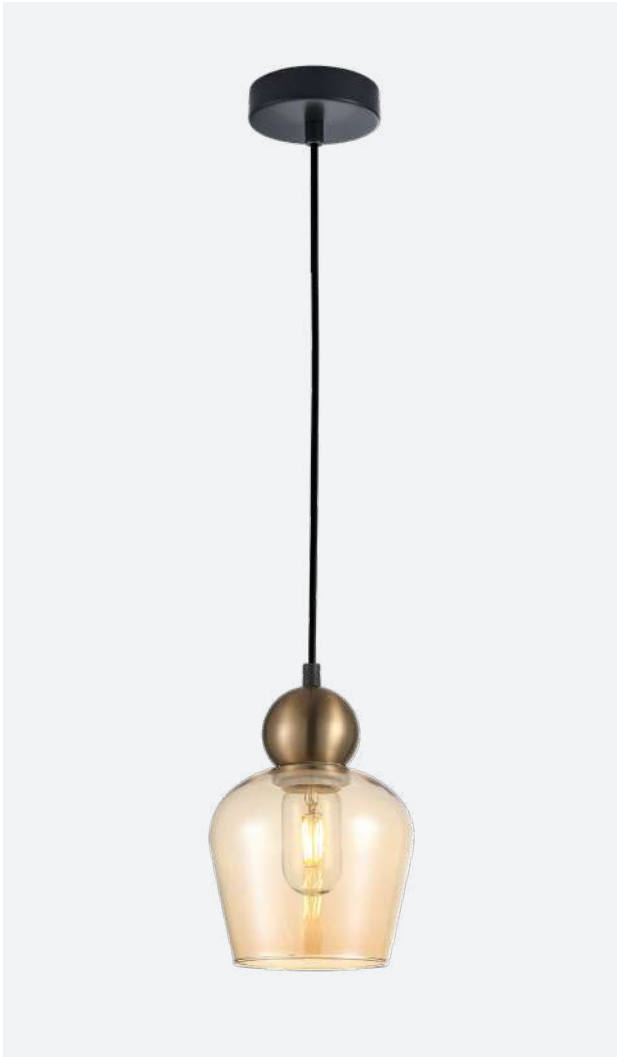

CHAMPAN1
(Amber Glass)

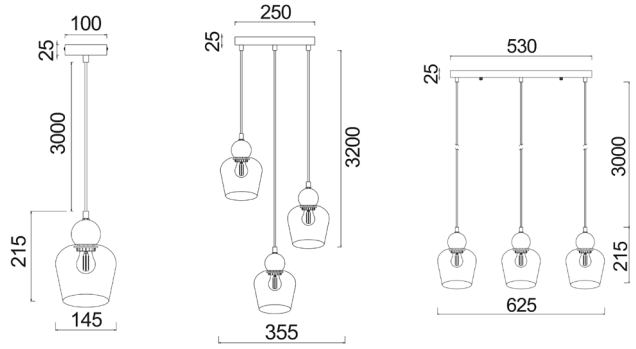

CHAMPAN1X3R
(Amber Glass)



CHAMPAN1X3S
(Amber Glass)



CHAMPAN2
(Smoecky Black Glass)



CHAMPAN2X3R
(Smoecky Black Glass)



CHAMPAN2X3S
(Smoecky Black Glass)



- Interior glass wine glass pendant lights
- Material: iron & glass
- Globe not included
- For indoor use only



Part No.	CHAMPAN1, CHAMPAN1X3R, CHAMPAN1X3S
Description	PENDANT ES 72W Wine Glass
Material	Iron & glass
Lamp Holder	CHAMPAN1: 1xE27 (Max.72W) CHAMPAN1X3R: 3xE27 (Max.72W) CHAMPAN1X3S: 3xE27 (Max.72W)
Dimensions	CHAMPAN1: Ø145 x H215mm CHAMPAN1X3R: Ø355mm CHAMPAN1X3S: L625 x H215mm
Suspension	3000mm black cable
Canopy Size	CHAMPAN1: Ø100 x 25mm CHAMPAN1X3R: Ø250 x 25mm CHAMPAN1X3S: L530 x 25mm
Carton QTY	1/1

Part No.	CHAMPAN2, CHAMPAN2X3R, CHAMPAN2X3S
Description	PENDANT ES 72W Wine Glass
Material	Iron & glass
Lamp Holder	CHAMPAN2: 1xE27 (Max.72W) CHAMPAN2X3R: 3xE27 (Max.72W) CHAMPAN2X3S: 3xE27 (Max.72W)
Dimensions	CHAMPAN2: Ø145 x H215mm CHAMPAN2X3R: Ø355mm CHAMPAN2X3S: L625 x H215mm
Suspension	3000mm black cable
Canopy Size	CHAMPAN2: Ø100 x 25mm CHAMPAN2X3R: Ø250 x 25mm CHAMPAN2X3S: L530 x 25mm
Carton QTY	1/1

Trattino Interior Pendant Lights

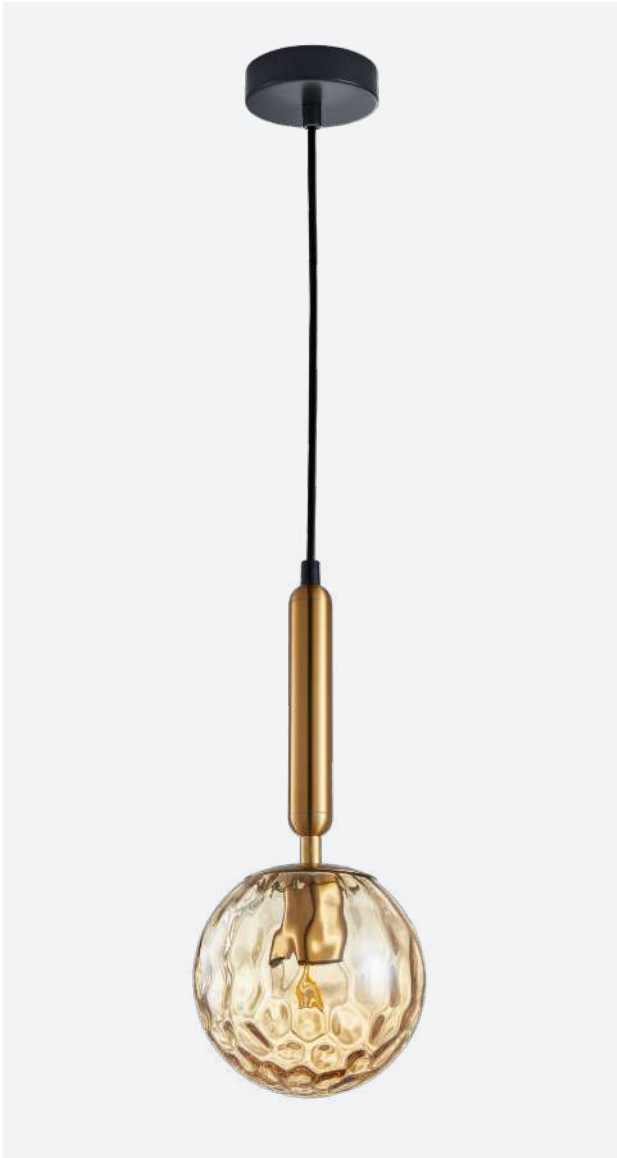

TRATTINO1
(Amber Glass)

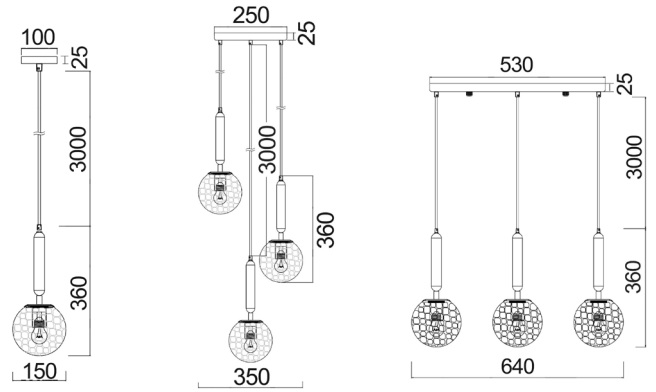

TRATTINO1X3R
(Amber Glass)



TRATTINO1X3S
(Amber Glass)

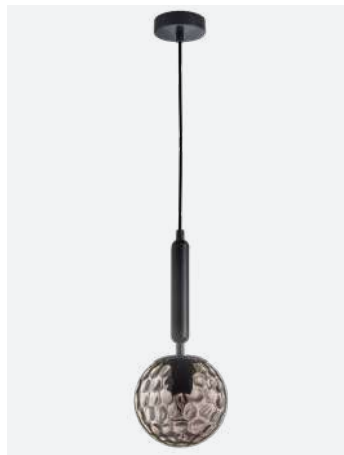

TRATTINO2
(Smoky Black Glass)



TRATTINO2X3R
(Smoky Black Glass)



TRATTINO2X3S
(Smoky Black Glass)

DECOR LIGHTING



- Interior sphere glass pendant lights
- Material: iron & glass
- Globe not included
- Globe size restriction: Ø42xL102mm
- Recommended globes: CLA candle/ fancy round globes
- For indoor use only



Part No.	TRATTINO1, TRATTINO1X3R, TRATTINO1X3S
Description	PENDANT ES 72W Glass Sphere
Material	Iron & glass
Lamp Holder	TRATTINO1: 1xE27 (Max.72W) TRATTINO1X3R: 3xE27 (Max.72W) TRATTINO1X3S: 3xE27 (Max.72W)
Dimensions	TRATTINO1: Ø150 x H360mm TRATTINO1X3R: Ø350mm TRATTINO1X3S: L640 x H360mm
Suspension	3000mm PVC cable
Canopy Size	TRATTINO1: Ø100 x 25mm TRATTINO1X3R: Ø250 x 25mm TRATTINO1X3S: L530 x 25mm
Carton QTY	1/1

Part No.	TRATTINO2, TRATTINO2X3R, TRATTINO2X3S
Description	PENDANT ES 72W Glass Sphere
Material	Iron & glass
Lamp Holder	TRATTINO2: 1xE27 (Max.72W) TRATTINO2X3R: 3xE27 (Max.72W) TRATTINO2X3S: 3xE27 (Max.72W)
Dimensions	TRATTINO2: Ø150 x H360mm TRATTINO2X3R: Ø350mm TRATTINO2X3S: L640 x H360mm
Suspension	3000mm PVC cable
Canopy Size	TRATTINO2: Ø100 x 25mm TRATTINO2X3R: Ø250 x 25mm TRATTINO2X3S: L530 x 25mm
Carton QTY	1/1

Tulip Interior Pendant Lights

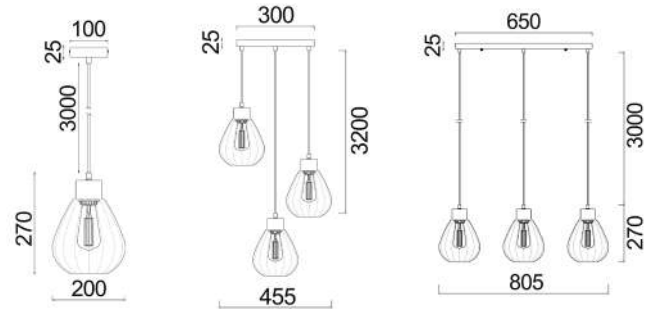
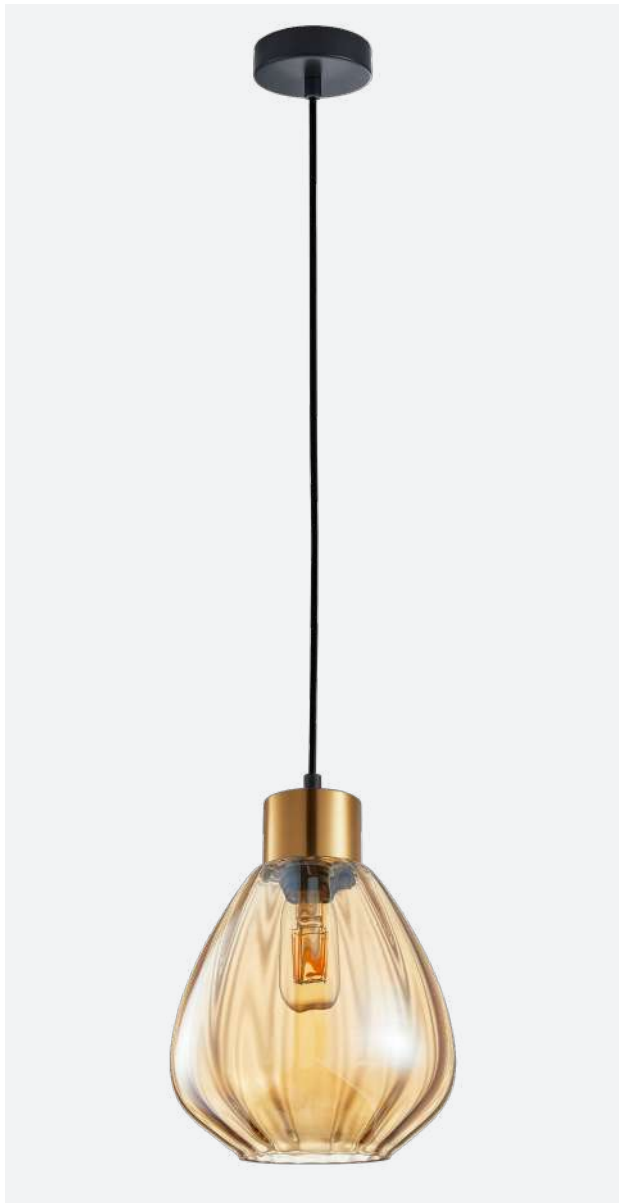

TULIP1
(Amber Glass)



TULIP1X3R
(Amber Glass)



TULIP1X3S
(Amber Glass)



TULIP2
(Smoekey Black Glass)



TULIP2X3R
(Smoekey Black Glass)



TULIP2X3S
(Smoekey Black Glass)

DECOR LIGHTING



- Interior wine glass ribbed pendant lights
- Material: iron & glass
- Globe not included
- For indoor use only



Part No.	TULIP1, TULIP1X3R, TULIP1X3S
Description	PENDANT ES 72W Wine Glass Ribbed With Brass Highlight
Material	Iron & glass
Lamp Holder	TULIP1: 1xE27 (Max.72W) TULIP1X3R: 3xE27 (Max.72W) TULIP1X3S: 3xE27 (Max.72W)
Dimensions	TULIP1: Ø200 x H270mm TULIP1X3R: Ø455mm TULIP1X3S: L650 x H270mm
Suspension	3000mm black cable
Canopy Size	TULIP1: Ø100 x 25mm TULIP1X3R: Ø300 x 25mm TULIP1X3S: L650 x 25mm
Carton QTY	1/1

Part No.	TULIP2, TULIP2X3R, TULIP2X3S
Description	PENDANT ES 72W Wine Glass Ribbed With Black Highlight
Material	Iron & glass
Lamp Holder	TULIP2: 1xE27 (Max.72W) TULIP2X3R: 3xE27 (Max.72W) TULIP2X3S: 3xE27 (Max.72W)
Dimensions	TULIP2: Ø200 x H270mm TULIP2X3R: Ø455mm TULIP2X3S: L650 x H270mm
Suspension	3000mm black cable
Canopy Size	TULIP2: Ø100 x 25mm TULIP2X3R: Ø300 x 25mm TULIP2X3S: L650 x 25mm
Carton QTY	1/1

Espejo Interior Pendant Lights



ESPEJO1
(Chrome glass with line effect)

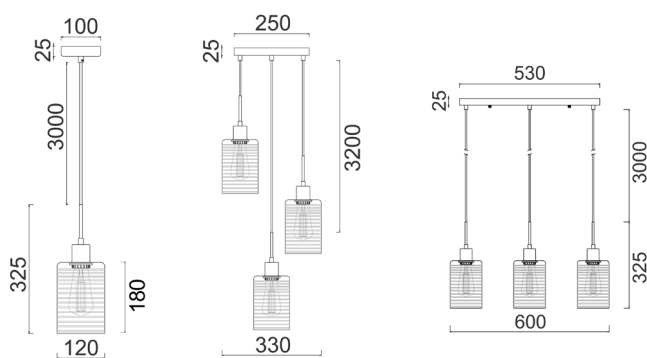

ESPEJO1X3R
(Chrome glass with line effect)



ESPEJO1X3S
(Chrome glass with line effect)

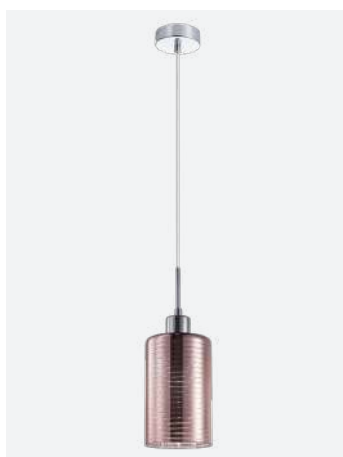

ESPEJO2
(Rose gold glass with line effect)

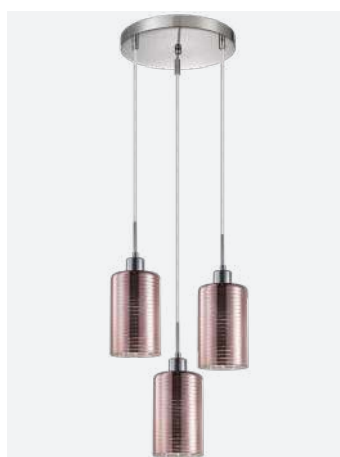

ESPEJO2X3R
(Rose gold glass with line effect)

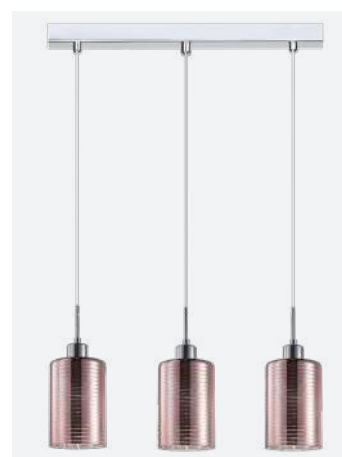

ESPEJO2X3S
(Rose gold glass with line effect)



- Interior line effect cylinder pendant lights
- Material: glass & iron
- Globe not included
- For indoor use only



Part No.	ESPEJO1, ESPEJO1X3R, ESPEJO1X3S
Description	PENDANT ES 72W Glass With Line Effect Cylinder
Material	Iron & glass
Lamp Holder	ESPEJO1: 1xE27 (Max.72W) ESPEJO1X3R: 3xE27 (Max.72W) ESPEJO1X3S: 3xE27 (Max.72W)
Dimensions	ESPEJO1: Ø120 x H325mm ESPEJO1X3R: Ø330mm ESPEJO1X3S: L600 x H325mm
Suspension	3000mm PVC cable
Canopy Size	ESPEJO1: Ø100 x 25mm ESPEJO1X3R: Ø250 x 25mm ESPEJO1X3S: L530 x 25mm
Carton QTY	1/1

Part No.	ESPEJO2, ESPEJO2X3R, ESPEJO2X3S
Description	PENDANT ES 72W Glass With Line Effect Cylinder
Material	Iron & glass
Lamp Holder	ESPEJO2: 1xE27 (Max.72W) ESPEJO2X3R: 3xE27 (Max.72W) ESPEJO2X3S: 3xE27 (Max.72W)
Dimensions	ESPEJO2: Ø120 x H325mm ESPEJO2X3R: Ø330mm ESPEJO2X3S: L600 x H325mm
Suspension	3000mm PVC cable
Canopy Size	ESPEJO2: Ø100 x 25mm ESPEJO2X3R: Ø250 x 25mm ESPEJO2X3S: L530 x 25mm
Carton QTY	1/1

Espejo Interior Pendant Lights



ESPEJO3
(Chrome glass with dotted effect)

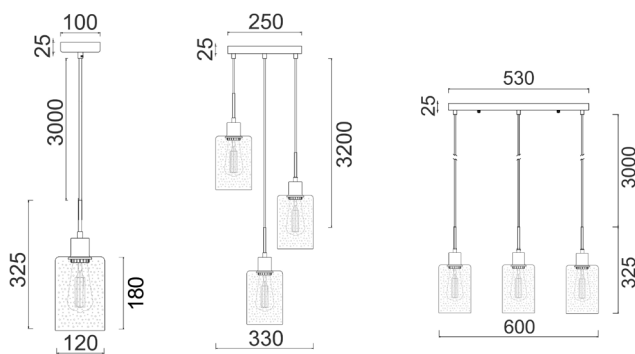

ESPEJO3X3R
(Chrome glass with dotted effect)



ESPEJO3X3S
(Chrome glass with dotted effect)



ESPEJO4
(Rose gold glass with dotted effect)



ESPEJO4X3R
(Rose gold glass with dotted effect)

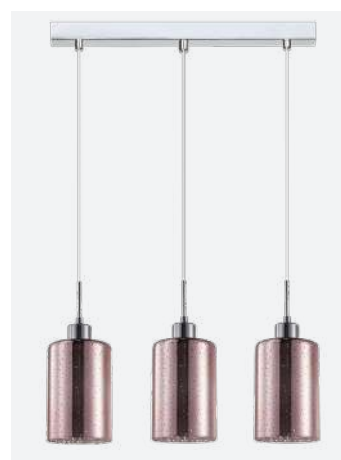

ESPEJO4X3S
(Rose gold glass with dotted effect)

DECOR LIGHTING



- Interior dotted effect cylinder pendant lights
- Material: glass & iron
- Globe not included
- For indoor use only



Part No.	ESPEJO3, ESPEJO3X3R, ESPEJO3X3S
Description	PENDANT ES 72W Glass With Dotted Effect cylinder
Material	Iron & glass
Lamp Holder	ESPEJO3: 1xE27 (Max.72W) ESPEJO3X3R: 3xE27 (Max.72W) ESPEJO3X3S: 3xE27 (Max.72W)
Dimensions	ESPEJO3: Ø120 x H325mm ESPEJO3X3R: Ø330mm ESPEJO3X3S: L600 x H325mm
Suspension	3000mm PVC cable
Canopy Size	ESPEJO3: Ø100 x 25mm ESPEJO3X3R: Ø250 x 25mm ESPEJO3X3S: L530 x 25mm
Carton QTY	1/1

Part No.	ESPEJO4, ESPEJO4X3R, ESPEJO4X3S
Description	PENDANT ES 72W Glass With Dotted Effect cylinder
Material	Iron & glass
Lamp Holder	ESPEJO4: 1xE27 (Max.72W) ESPEJO4X3R: 3xE27 (Max.72W) ESPEJO4X3S: 3xE27 (Max.72W)
Dimensions	ESPEJO4: Ø120 x H325mm ESPEJO4X3R: Ø330mm ESPEJO4X3S: L600 x H325mm
Suspension	3000mm PVC cable
Canopy Size	ESPEJO4: Ø100 x 25mm ESPEJO4X3R: Ø250 x 25mm ESPEJO4X3S: L530 x 25mm
Carton QTY	1/1

Ciotola Interior Pendant Lights



CIOTOLA1 - Small
CIOTOLA3 - Medium
CIOTOLA5 - Large
 (Matte Black)



CIOTOLA2 - Small
CIOTOLA4 - Medium
CIOTOLA6 - Large
 (Antique Brass)

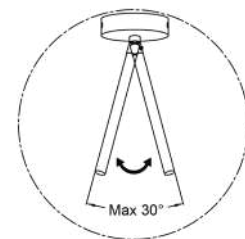

ROD TILT ANGLE MAX.30°

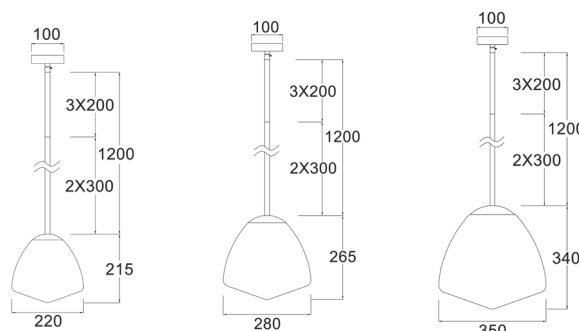

- Interior cone(Concave) tipped opal glass pendant lights
- Material: opal glass & iron
- Globe not included
- Globe size restrictions (max. diameter):
 CIOTOLA1-2: 40mm; CIOTOLA3-4: 50mm;
 CIOTOLA5-6: 70mm
- Rod tilt angle: max.30°
- For indoor use only



Part No.	CIOTOLA1-6
Description	PENDANT ES 40W Cone(Concave) Tipped Opal Glass
Material	Glass & iron
Lamp Holder	1xE27 (Max.40W)
Dimensions	CIOTOLA1-2: Ø220 x H215mm CIOTOLA3-4: Ø280 x H265mm CIOTOLA5-6: Ø350 x H340mm
Suspension	3x200mm + 2x300mm rods (Note: rods can be removed to reach desired length)
Canopy Size	Ø100 x 25mm
Carton QTY	1/1

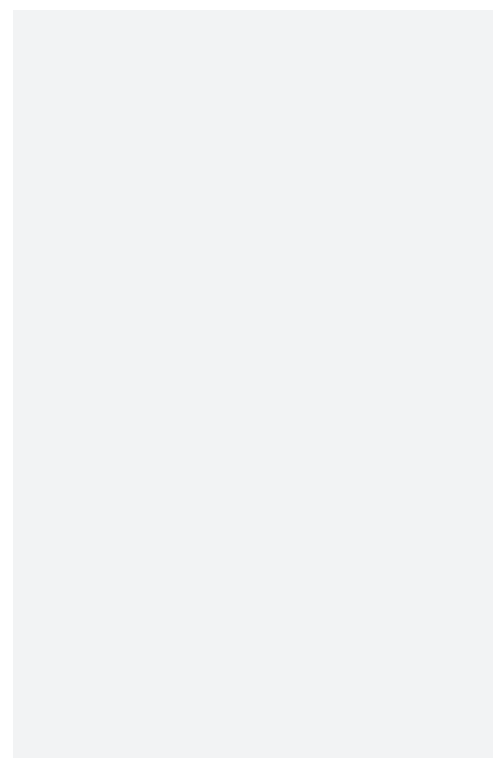

DECOR LIGHTING

Fossette Interior Pendant Lights



FOSSETTE1
(Angled Bell)

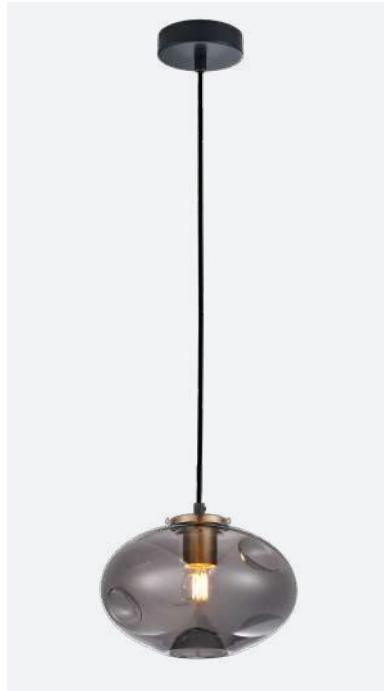

FOSSETTE2
(Oval)

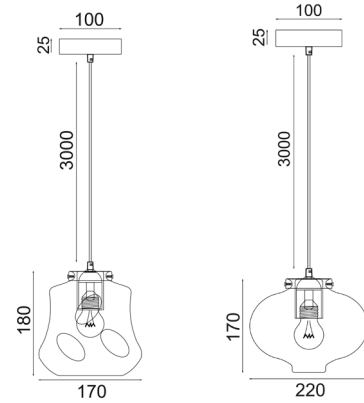

FOSSETTE3
(Sami Sphere Dome)



FOSSETTE4
(Ellipse)

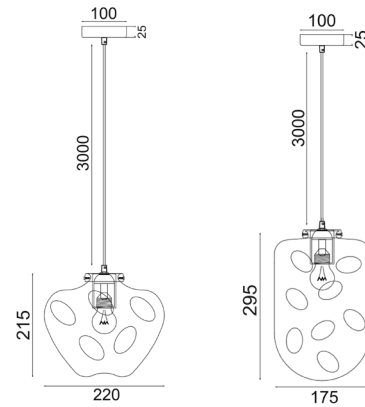

DECOR LIGHTING

- Interior dimpled smokey glass pendant lights
- Material: glass & iron
- Globe not included
- Globe size restriction(max. diameter): 45mm
- For indoor use only



*Product images have a warm white light source 'on'

Part No.	FOSSETTE1-4
Description	PENDANT ES 40W Smokey Glass with Antique Brass Highlights
Material	Glass & iron
Lamp Holder	1xE27 (Max.40W)
Dimensions	FOSSETTE1: Ø170 x H180mm FOSSETTE2: Ø220 x H170mm FOSSETTE3: Ø220 x H215mm FOSSETTE4: Ø175 x H295mm
Suspension	3000mm PVC cable
Canopy Size	Ø100 x 25mm
Carton QTY	1/1



Mikro Interior Pendant Lights



MIKRO1
(Matte Black Cylinder & Brass Mesh)



MIKRO2
(Antique Brass Cylinder & Chrome Mesh)

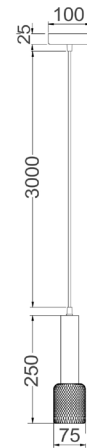

- Interior cylinder & mesh pendant lights
- Material: iron
- Globe not included
- For indoor use only



Part No.	MIKRO1-2
Description	PENDANT SES Cylinder & Mesh
Material	Iron
Lamp Holder	1xE14 (Max.40W)
Dimensions	Ø75 x H250mm
Suspension	3000mm PVC black cable
Canopy Size	Ø100 x 25mm
Carton QTY	1/1

Corazon Interior Pendant Lights



CORAZON1
(Matte Black/ Copper Diamond Wire)



CORAZON2
(Antique Brass/ Matte Black Sphere Wire)

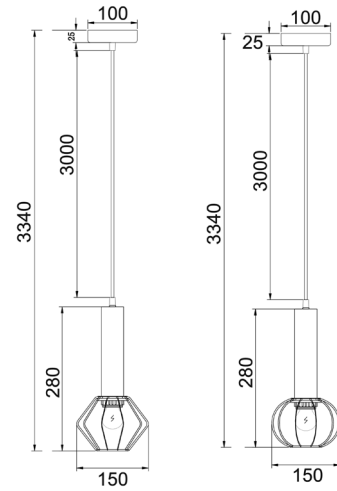

- Interior diamond / sphere wire pendant lights
- Material: iron
- Globe not included
- Globe size restrictions (max.diameter): 60mm(GLS)
- For indoor use only



Part No.	CORAZON1-2
Description	CORAZON1: PENDANT ES 72W Matt black Copper Diamond Wire CORAZOR2: PENDANT ES 72W Antique Brass Matt Black Sphere Wire
Material	Iron
Lamp Holder	1xE27 (Max.72W)
Dimensions	Ø150 x H280mm
Suspension	3000mm PVC cable
Canopy Size	Ø100 x 25mm
Carton QTY	1/10



Ida Interior Pendant Lights

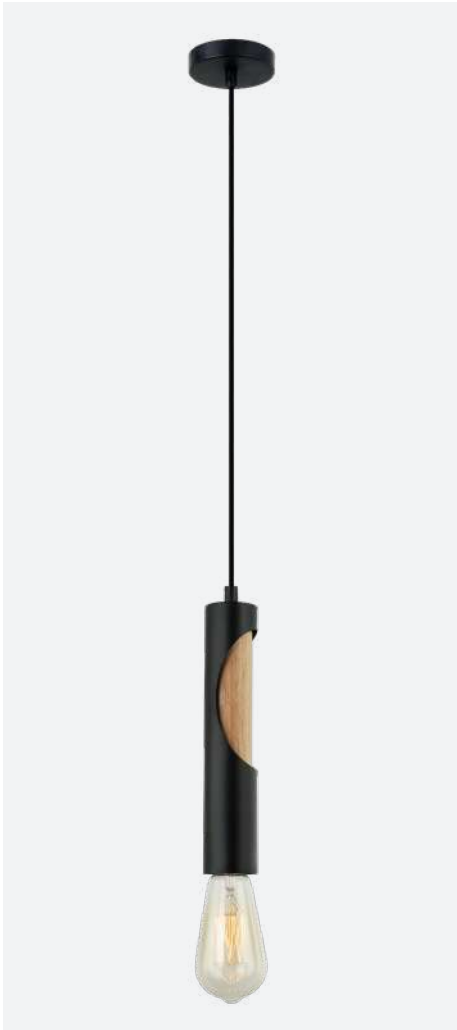

IDA1
(Matte Black/ Blonde Wood)



IDA2
(Matte White/ Blonde Wood)

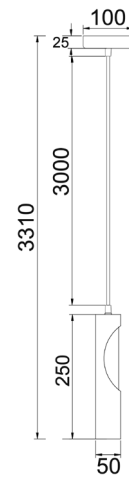

- Interior cylinder pendant lights
- Material: iron & blonde wood
- Globe not included
- For indoor use only



Part No.	IDA1-2
Description	PENDANT ES 72W Iron with Blonde Wood Cylinder
Material	Iron & wood
Lamp Holder	1xE27 (Max.72W)
Dimensions	Ø50 x H250mm
Suspension	3000mm PVC cable
Canopy Size	Ø100 x 25mm
Carton QTY	1/10



Golda Interior Pendant Lights



GOLDA1
(Matte Black/ Diagonal Antique Brass Feature)



GOLDA2
(Matte Black/ Vertical Antique Brass Feature)

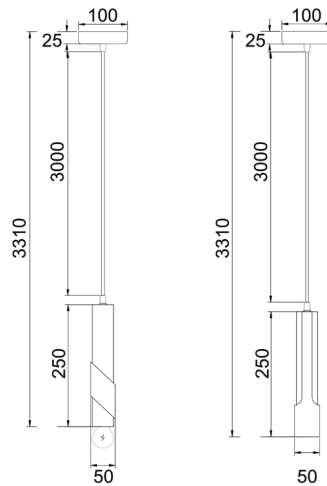

- Interior cylinder pendant lights
- Material: iron
- Globe not included
- For indoor use only



Part No.	GOLDA1-2
Description	PENDANT ES 72W Matte Black Diagonal/ Vertical Antique Brass Feature Cylinder
Material	Iron
Lamp Holder	1xE27 (Max.72W)
Dimensions	Ø50 x H250mm
Suspension	3000mm PVC cable
Canopy Size	Ø100 x 25mm
Carton QTY	1/10



Vaina Interior Pendant Lights



VAINA1
(Matte Black)



VAINA2
(Matte White)

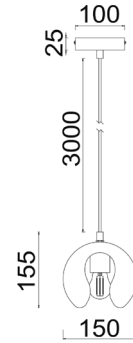

VAINA3
(Matte Gold)

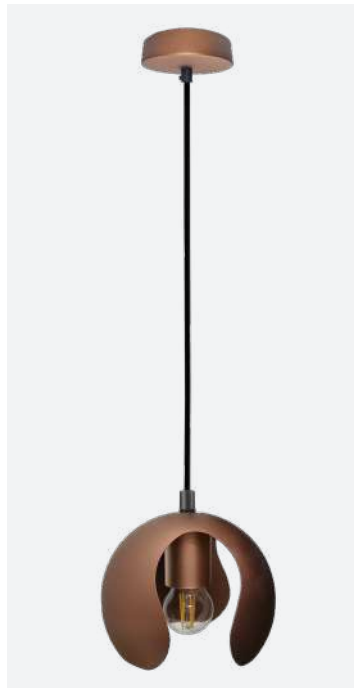

VAINA4
(Antique Copper)



- Interior wine glass with three petals pendant lights
- Material: iron
- Globe not included
- For indoor use only



Part No.	VAINA1-4
Description	PENDANT ES 72W Wine Glass with Three Petals
Material	Iron
Lamp Holder	1xE27 (Max.72W)
Dimensions	Ø150 x H155mm
Suspension	3000mm PVC cable
Canopy Size	Ø100 x 25mm
Carton QTY	1/1

Bella Interior Pendant Lights

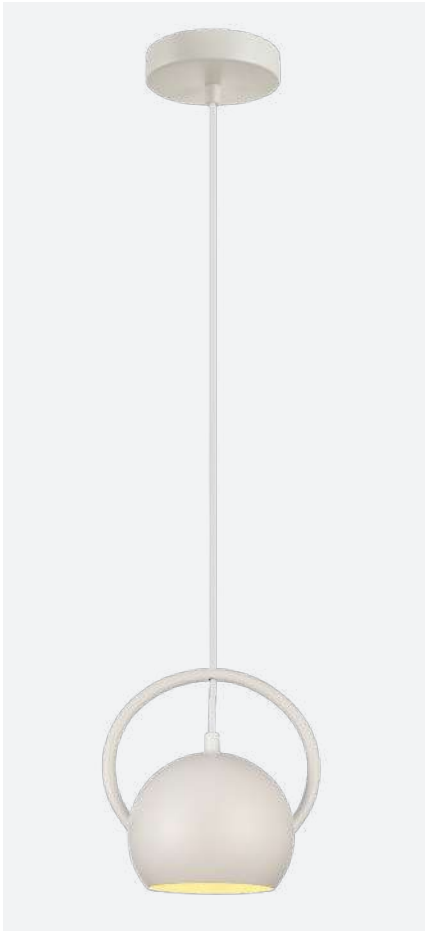

BELLA1
(Matte white)



BELLA2
(Matte Black)

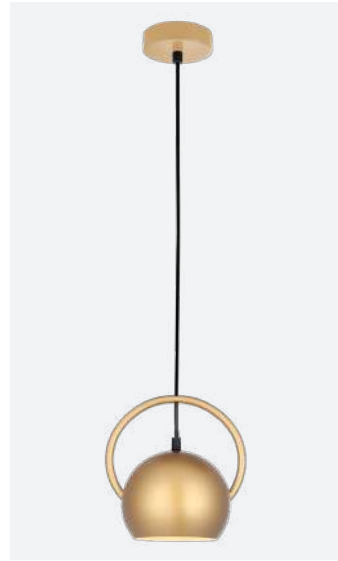

BELLA3
(Matte Gold)

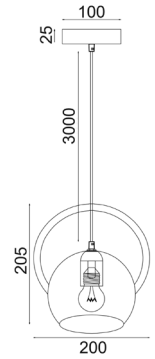

*Matte gold interior

- Interior wine glass iron pendant lights
- Material: iron
- Shade interior colour: matte gold
- Globe not included
- For indoor use only



Part No.	BELLA1-3
Description	PENDANT ES 72W Wine Glass with Matte Gold Interior
Material	Iron
Lamp Holder	1xE27 (Max.72W)
Dimensions	Ø200 x H205mm
Suspension	3000mm PVC cable
Canopy Size	Ø100 x 25mm
Carton QTY	1/1

*Product images have a warm white light source 'on'



Escama Interior Pendant Lights



ESCAMA1
(Black)

*Product images have a warm white light source 'on'



ESCAMA2
(White)

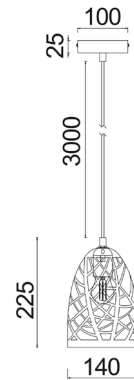

- Interior iron ellipse perforated (triangles) pendant lights
- Material: iron
- Globe not included
- For indoor use only



Part No.	ESCAMA1-2
Description	PENDANT ES 72W Iron Ellipse Perforated (Triangles)
Material	Iron
Lamp Holder	1xE27 (Max.72W)
Dimensions	Ø140 x H225mm
Suspension	3000mm PVC cable
Canopy Size	Ø100 x 25mm
Carton QTY	1/1



Cleo Interior Pendant Lights



CLEO1
(Cut Glass)



- Interior cylinder clear embossed glass pendant light
- Material: iron & glass
- Globe not included
- Globe size restriction: only candle shaped globes will fit
- For indoor use only

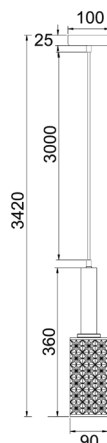

Part No.	CLEO1
Description	PENDANT SES 72W Cylinder Clear Embossed Glass with Matt Black & Brass Highlight
Material	Iron & glass
Lamp Holder	1xE14 (Max.72W)
Dimensions	Ø90 x H360mm
Suspension	3000mm PVC cable
Canopy Size	Ø100 x 25mm
Carton QTY	1/1

*Product images have a warm white light source 'on'

Pastille Interior Pendant Lights



PASTILLE1
(Smokey Glass & Satin Chrome Highlight)

- Interior cylinder pendant lights
- Material: iron & glass
- Globe not included
- Globe size restriction (max.diameter): 60mm
- For indoor use only



Part No.	PASTILLE1-2
Description	PENDANT ES 72W Cylinder with Highlight
Material	Iron & glass
Lamp Holder	1xE27 (Max.72W)
Dimensions	Ø80 x H300mm
Suspension	3000mm PVC cable
Canopy Size	Ø100 x 25mm
Carton QTY	1/1

*Product images have a warm white light source 'on'



PASTILLE2
(Amber Glass & Antique Brass Highlight)

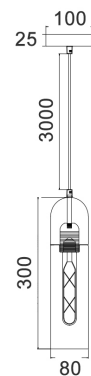

Papillon Interior Pendant Lights



PAPILLON1
(Matte Black & Clear Glass)



PAPILLON2
(Antique Brass & Amber Glass)

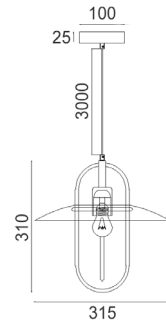

- Interior coolie with oval glass pendant lights
- Material: iron & glass
- Globe not included
- Globe size restriction (max diameter): 95mm(G95)
- For indoor use only



Part No.	PAPILLON1-2
Description	PENDANT ES 72W Coolie with Oval Glass
Material	Iron & glass
Lamp Holder	1xE27 (Max.72W)
Dimensions	Ø315 x H310mm
Suspension	3000mm PVC cable
Canopy Size	Ø100 x 25mm
Carton QTY	1/1

*Product images have a warm white light source 'on'



Chapeau Interior Pendant Lights



CHAPEAU1 - Small
CHAPEAU3 - Large
 (Smokey Glass/ Satin Chrome Highlight)



CHAPEAU2 - Small
CHAPEAU4 - Large
 (Amber Glass/ Antique Brass Highlight)

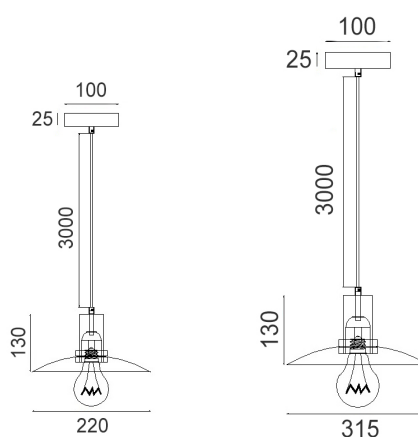

- Interior glass coolie pendant lights
- Material: iron & glass
- Globe not included
- For indoor use only



Part No.	CHAPEAU1-4
Description	PENDANT ES 72W Glass Coolie with Highlight
Material	Iron & glass
Lamp Holder	1xE27 (Max.72W)
Dimensions	CHAPEAU1-2: Ø220 x H130mm CHAPEAU3-4: Ø315 x H130mm
Suspension	3000mm PVC cable
Canopy Size	Ø100 x 25mm
Carton QTY	1/1

Contour Interior Pendant Lights

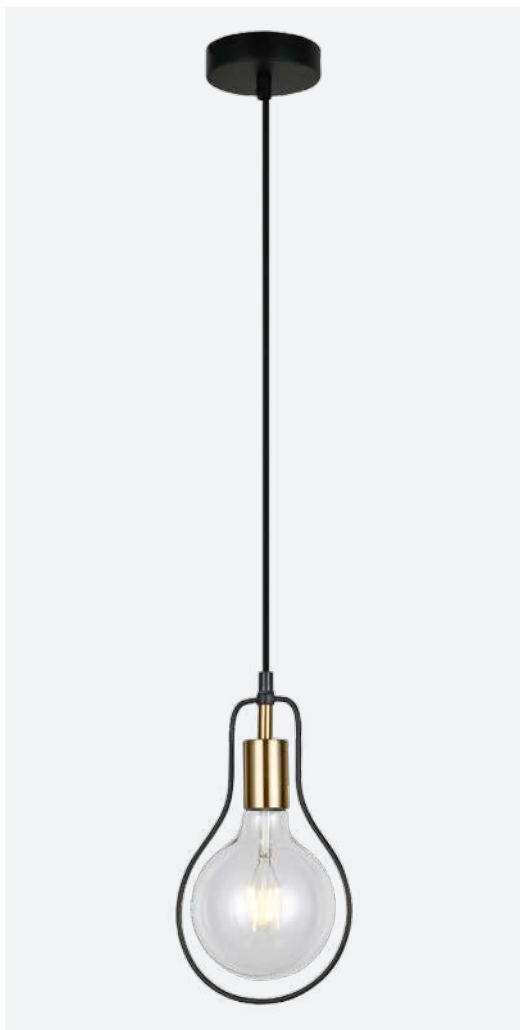

CONTOUR1
(Pear Shape)

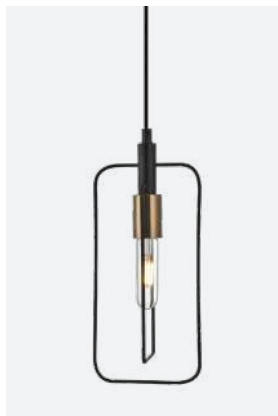

CONTOUR2
(Rectangular Shape)

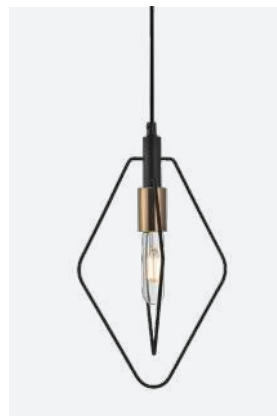

CONTOUR3
(Diamond Shape)

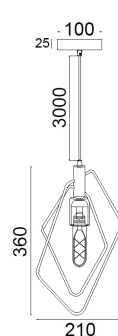
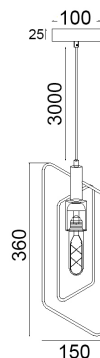
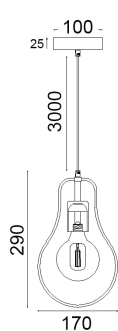

- Interior black wire pendant lights
- Material: iron
- Globe not included
- Globe size restrictions (max.diameter):
CONTOUR1: 125mm (G125); CONTOUR2: 57mm (ST57); CONTOUR3: 95mm (G95)
- For indoor use only



Part No.	CONTOUR1-3
Description	PENDANT ES 72W BLK WIRE with Antique Brass Highlight
Material	Iron
Lamp Holder	1xE27 (Max.72W)
Dimensions	CONTOUR1: W170 x H290mm CONTOUR2: W150 x H360mm CONTOUR3: W210 x H360mm
Suspension	3000mm PVC cable
Canopy Size	Ø100 x 25mm
Carton QTY	1/10



Abbey Interior Pendant Lights





ABBEY1
(Matte Black)

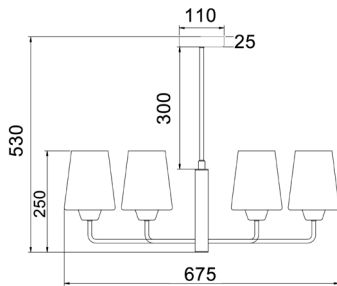

- Interior candelabra pendant lights
- Material: iron & opal glass
- Globe not included
- For indoor use only



Part No.	ABBEY1-2
Description	PENDANT ES x 6 72W Candelabra
Material	Iron, opal glass
Lamp Holder	6xE27 (Max.72W)
Dimensions	Ø675 x H250mm
Suspension	300mm rod
Canopy Size	Ø110 x 25mm
Carton QTY	1/1



ABBEY2
(Matte Gold)



Hexade Interior Pendant Lights



HEXADE1
(Matte Black)



HEXADE2
(Matte Gold)

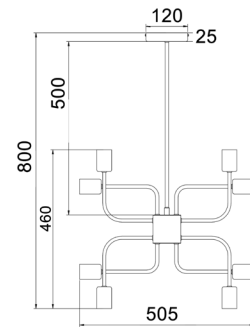

- Interior candelabra pendant lights
- Material: iron
- Globe not included
- For indoor use only



Part No.	HEXADE1-2
Description	PENDANT ES x 16 72W Candelabra
Material	Iron
Lamp Holder	16xE27 (Max.72W)
Dimensions	Ø505 x H460mm
Suspension	500mm rod
Canopy Size	Ø120 x 25mm
Carton QTY	1/1

*Product images have a warm white light source 'on'



Hexa Interior Pendant Lights



HEXA1
(Matte Black)



HEXA2
(Matte Gold)

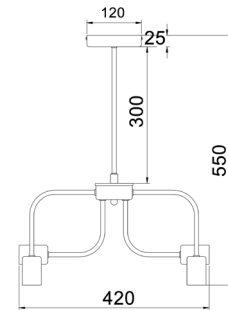

- Interior candelabra pendant lights
- Material: iron
- Globe not included
- For indoor use only



Part No.	HEXA1-2
Description	PENDANT ES x 6 72W Candelabra
Material	Iron
Lamp Holder	6xE27 (Max.72W)
Dimensions	Ø420mm
Suspension	300mm rod
Canopy Size	Ø120 x 25mm
Carton QTY	1/1

*Product images have a warm white light source 'on'



Strato Interior Pendant Lights

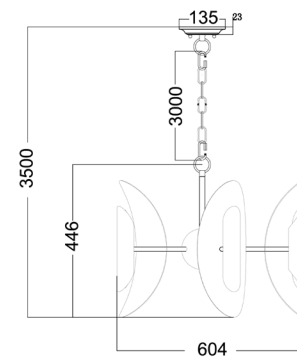
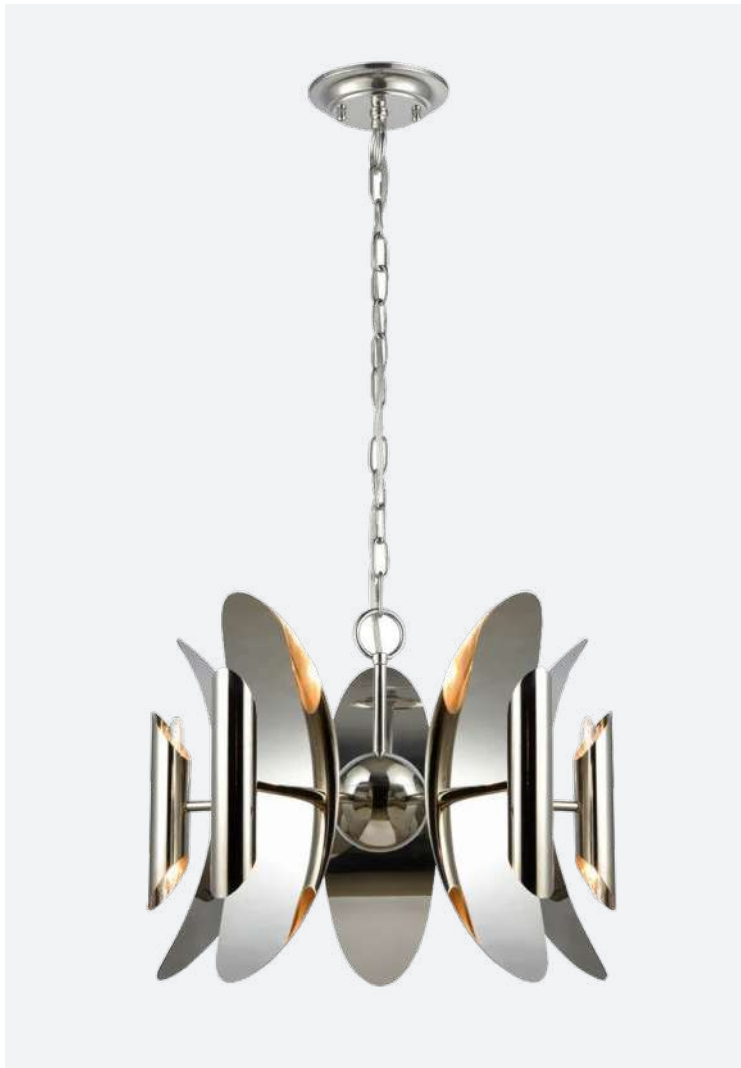

STRATO1

- Interior oval & tube stainless steel and round stepped with polished nickel pendant light
- Material: iron & stainless steel
- Globe not included
- Suitable for E14 base candle globes only
- For indoor use only



Part No.	STRATO1
Description	PENDANT Oval & Tube SS + Round Stepped with Polished Nickel + Round Stepped Polished Nickel Canopy
Material	Iron, stainless steel
Lamp Holder	10xE14 (Max.60W)
Dimensions	Ø604 x H446mm
Suspension	3000mm chrome colour cable & chain
Canopy Size	Ø135 x 23mm
Carton QTY	1/1



Mazza Interior Pendant Lights



MAZZA

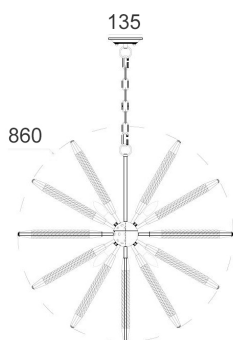

- Interior sea anemone natural rope with Weathered Zinc pendant light
- Material: natural rope with weathered zinc
- Globe not included
- Recommended globes: CLA E14 base candle globes
- For indoor use only



Part No.	MAZZA
Description	PENDANT SES x 8 60W Sea Anemone Natural Rope with Weathered Zinc + Round Stepped with Zinc Canopy
Material	Iron, natural rope
Lamp Holder	8xE14 (Max.60W)
Dimensions	Ø860 x H860mm
Suspension	3000mm cable & chain
Canopy Size	Ø135 x 23mm
Carton QTY	1/1

Sputnik Interior Pendant Lights



SPUTNIK1

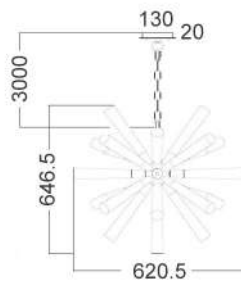

- Interior sea anemone dark grey & washed wood with nickel pendant light
- Material: polished nickel & wood
- Globe not included
- For indoor use only



SPUTNIK2 interior wall light is also available

Part No.	SPUTNIK1
Description	PENDANT ESX6 60W Sea Anemone Dark Grey & Washed Wood with Nickel + Round Nickel Canopy
Material	Polished nickel, wood
Lamp Holder	6xE27 (Max.60W)
Dimensions	Ø620.5 x H646.5mm
Suspension	3000mm cable & chain
Canopy Size	Ø130 x 20mm
Carton QTY	1/1

Hopi Interior Pendant Lights

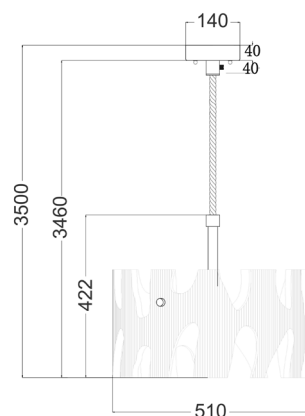
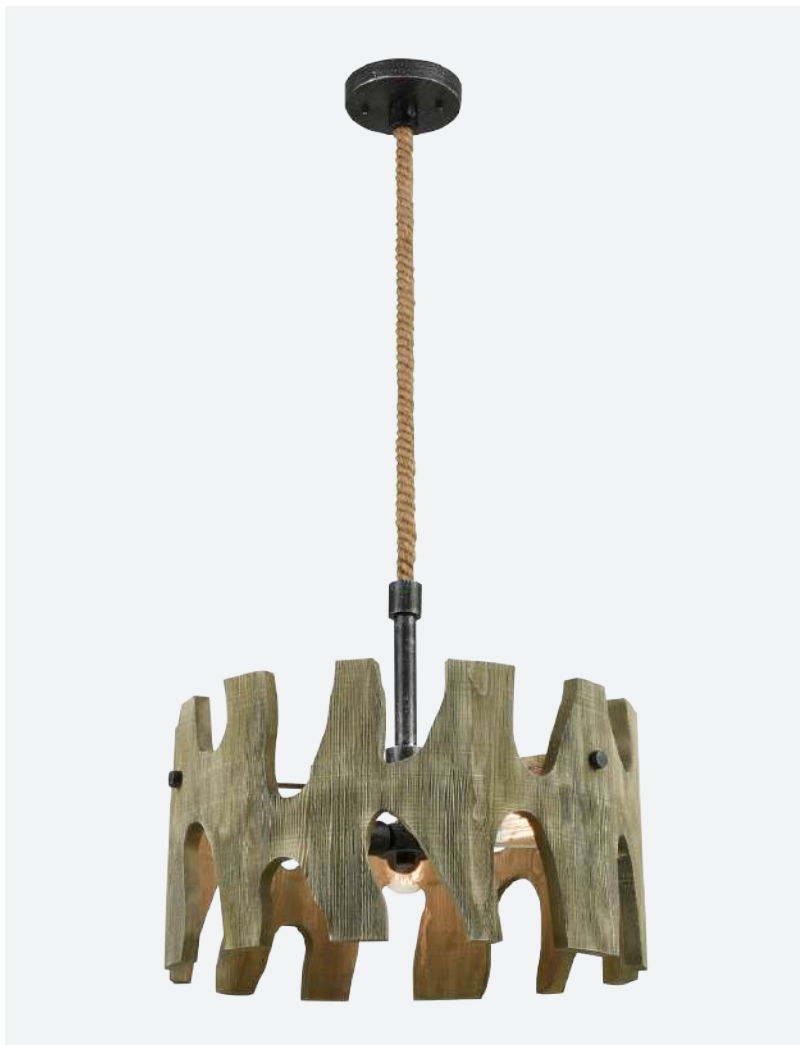

HOP101

- Interior drum weathered grey wood pendant light
- Shade: weathered grey wood
- Globe not included
- Not suitable for use with any globe larger than GLS
- For indoor use only



Part No.	HOP101
Description	PENDANT ES 3 x 60W Drum Weathered Grey Wood + Round Bronze Canopy
Material	Wood, bronzed iron & rope
Lamp Holder	3xE27 (Max.60W)
Dimensions	Ø510 x H422mm
Suspension	Bronze iron rod + 3000mm rope
Canopy Size	Ø140 x 40mm
Carton QTY	1/1



Bonito Interior Pendant Lights





BONITO1
(Taupe Wood)



BONITO6
(Winter Moss Wood)



BONITO2
(Taupe Wood)



BONITO7
(Winter Moss Wood)



BONITO3
(Taupe Wood)



BONITO8
(Winter Moss Wood)



NOTE:

- (1) Adjustable knuckle(45°). Suitable for raked ceiling.
- (2) Can be mounted with any combination of short and long rods.

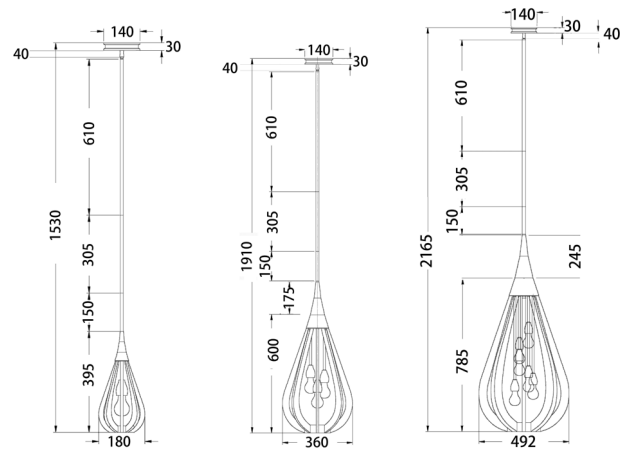

- Interior tear drop wood pendant lights
- Material: nickel & taupe OR winter moss finished wood
- Globe not included
- For indoor use only



Part No.	BONITO1-3 & BONITO6-8
Description	PENDANT ES Wood SML/ MED/ LGE Tear Drop w/Nickel + Rods + RND Nickel Canopy
Material	Nickel & wood
Lamp Holder	BONITO1&6: 1xE27 (Max.60W) BONITO2&7: 3xE27 (Max.60W) BONITO3&8: 6xE27 (Max.60W)
Dimensions	BONITO1&6: Ø180 x H395mm BONITO2&7: Ø360 x H775mm BONITO3&8: Ø492 x H1030mm
Suspension	150+3305+610mm rods
Canopy Size	Ø140x30mm
Carton QTY	1/1

Khaleesi Interior Pendant Lights



KHALEESI1

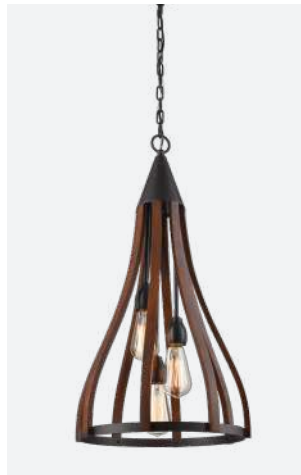

KHALEESI2

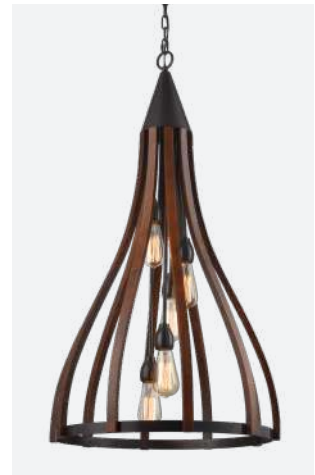

KHALEESI3

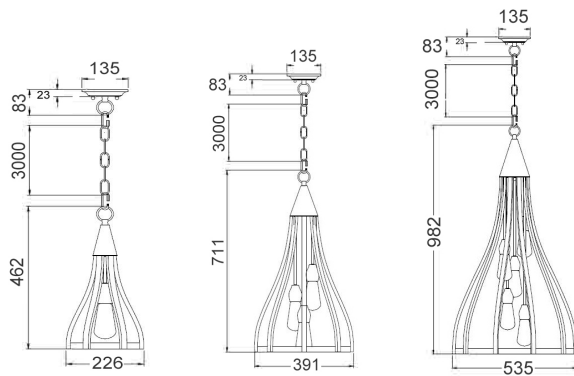

- Interior dark red oak wood bell pendant lights
- Material: oak dark red wood with oiled bronze hardware
- Globe not included
- For indoor use only



Part No.	KHALEESI1-3
Description	PENDANT Oak Dark Red Wood Small / Medium/ Large Bell + Round Stepped Oiled Bronze Canopy
Material	Iron & wood
Lamp Holder	KHALEESI1: 1XE27 (Max.60W) KHALEESI2: 3XE27 (Max.60W) KHALEESI3: 5XE27 (Max.60W)
Dimensions	KHALEESI1: Ø226 x H462mm KHALEESI2: Ø391 x H711mm KHALEESI3: Ø535 x H982mm
Suspension	3000mm chain & cable
Canopy Size	Ø135x23mm
Carton QTY	1/1



Meti Interior Pendant Lights



METI01



METI02



METI interior wall light is also available

- Interior rectangular / bar pendant lights
- Material: iron, wood & glass
- Oil rubbed bronze rods+trim+mounted plates
- Globe not included
- For indoor use only

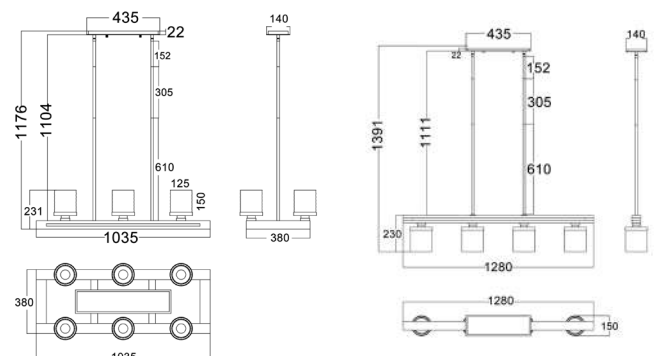

Part No.	METI01-02
Description	PENDANT ES 60W Warm Chestnut Wood Frame Rect / Bar Clear Glass Shades Oil Rubbed Bronze Hardware
Material	Iron, wood & glass
Lamp Holder	METI01: 6xE27 (Max.60W) METI02: 4xE27 (Max.60W)
Dimensions	METI01: L1035 x W380mm METI02: L1280 x W150mm
Suspension	METI01: Rod, see line drawing (Min:305mm; Max: 1067mm) METI02: Rod, see line drawing (Any combination of rods can be used)
Canopy Size	L435 x W140 x D22mm
Carton QTY	1/1

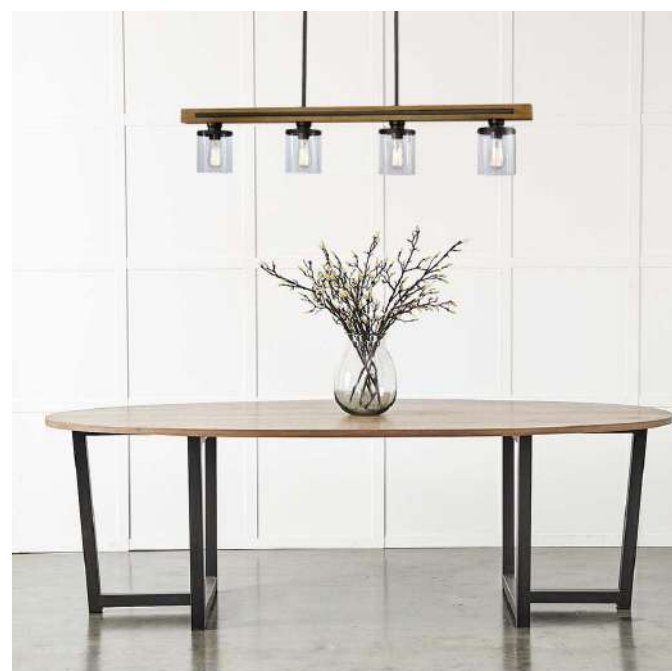

Senorita Interior Pendant Lights

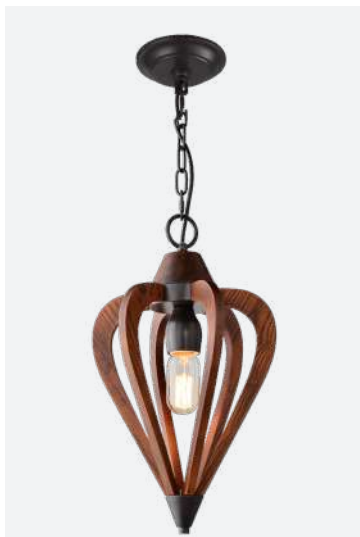

SENORITA1
(Tuscan Coffee Cherry Wood)



SENORITA4
(Winter Moss Wood)

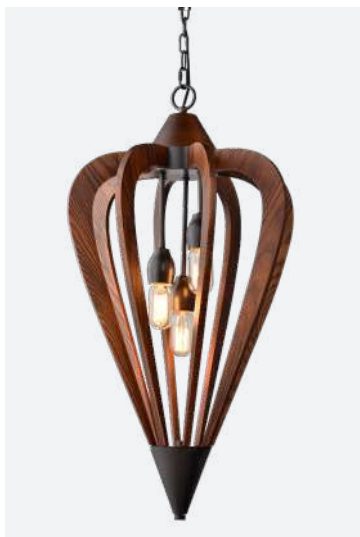

SENORITA2
(Tuscan Coffee Cherry Wood)



SENORITA5
(Winter Moss Wood)

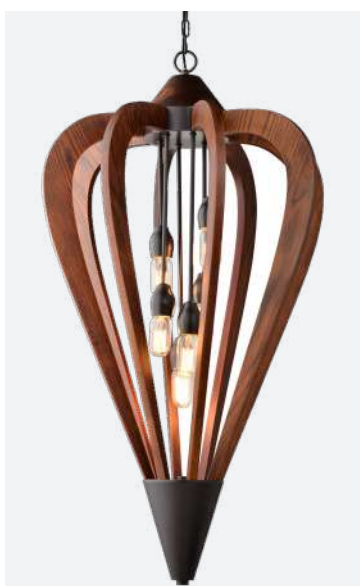

SENORITA3
(Tuscan Coffee Cherry Wood)



SENORITA6
(Winter Moss Wood)

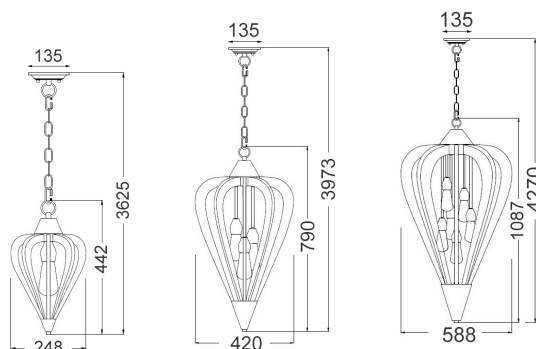

- Interior wood arrow shape pendant lights
- Shade: ashtree / cherry wood
- Colour: Tuscan coffee/ Winter moss
- Globe not included
- For indoor use only



Part No.	SENORITA1-6
Description	PENDANT ES Wood SML/ MED/ LGE Arrow + RND Stepped Oiled Brz / Polished Nickel Canopy
Material	Wood
Lamp Holder	SENORITA1&4: 1xE27 (Max.60W) SENORITA2&5: 3xE27 (Max.60W) SENORITA3&6: 6xE27 (Max.60W)
Dimensions	SENORITA1&4: Ø248 x H442mm SENORITA2&5: Ø420 x H790mm SENORITA3&6: Ø588 x H1087mm
Suspension	3000mm chain & cable
Canopy Size	Ø135x23mm
Carton QTY	1/1

*Some assembly **MAY BE** required

Pendolo Interior Pendant Lights



PENDOLO1
(Weathered Charcoal Hardware & Washed Wood)

- Interior ellipse caged wood and clear diffuser pendant lights
- Shade: iron, wood & glass
- Globe not included
- For indoor use only



Part No.	PENDOLO1-2
Description	PENDANT ES X 1 Ellipse Caged Wood and Clear Diffuser + Round St Charcoal / Brass Canopy
Material	Wood, iron & glass
Lamp Holder	1xE27 (Max.60W)
Dimensions	Ø180 x H517mm
Suspension	3000mm chain & cable
Canopy Size	Ø135x23mm
Carton QTY	1/1

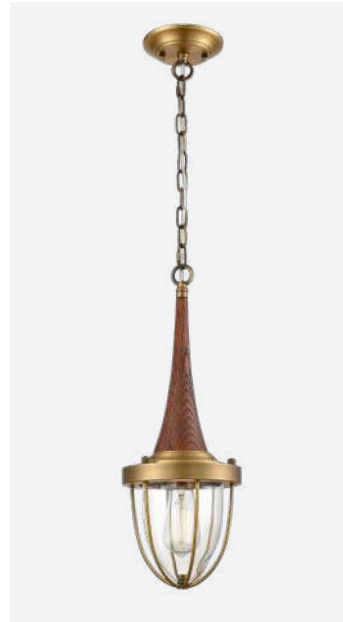

PENDOLO2
(Satin Brass Hardware & Dark Wood)

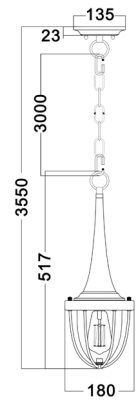

Autumn Interior Pendant Lights





AUTUMN01
(Small)

- Interior drum perforated (trees) aged bronze pendant lights
- Shade: iron with aged bronze finish & PC
- Globe not included
- For indoor use only

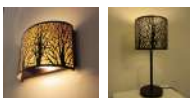

AUTUMN interior wall light and table lamp are also available.



AUTUMN02
(Large)



Note:

- (1) Adjustable knuckle. Suitable for raked ceiling.
- (2) Can be mounted with the shortest rod only or any combination of short and long rods

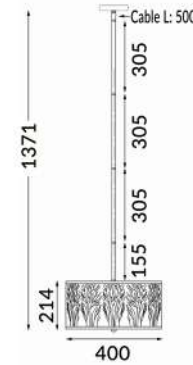
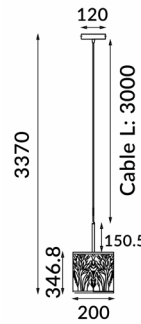

Part No.	AUTUMN01
Description	PENDANT Small Round Aged Bronze with Amber Lining with Amber Interior +Round Aged Bronze Canopy
Material	Iron & PC
Lamp Holder	1xE27 (Max.60W)
Dimensions	Ø220 x H337mm
Suspension	3000mm cable + 150.5mm rod
Canopy Size	Ø120mm
Carton QTY	1/1

Part No.	AUTUMN02
Description	PENDANT Large Round Aged Bronze with Amber Lining Frosted Glass Diffuser with Amber Interior + Rod + Round Aged Bronze Canopy
Material	Iron, PC & glass
Lamp Holder	3xE27 (Max.60W)
Dimensions	Ø400 x H200mm
Suspension	500mm cable + 155+305+305+305mm rods
Canopy Size	Ø120mm
Carton QTY	1/1

Tambura Interior Pendant Lights



TAMBURA01 - Small
(White)



TAMBURA02 - Small
(Black)

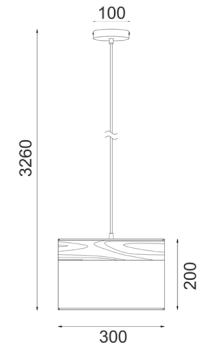
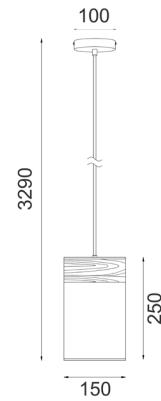

TAMBURA03 - Medium
TAMBURA05 - Large
(White)



TAMBURA04 - Medium
TAMBURA06 - Large
(Black)

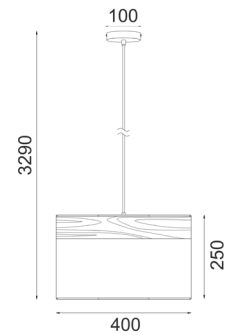

- Interior cylinder cloth shade pendant lights
- Shade: cloth shade with wood veneer trim
- Shade interior colour: white
- Globe not included
- For indoor use only



*Product images have a warm white light source 'ON'.
*TAMBURA table lamps and floor lamps are also available

Part No.	TAMBURA01-06
Description	PENDANT Cylinder Cloth Shade with Blonde Wood veneer Trim + Round Canopy
Material	Cloth
Lamp Holder	1xE27 (Max.72W)
Dimensions	TAMBURA01-02: Ø150 x H250mm TAMBURA03-04: Ø300 x H200mm TAMBURA05-06: Ø400 x H250mm
Suspension	3000mm PVC cable
Canopy Size	Ø100x25mm
Carton QTY	1/1



Swing Interior Pendant Lights





SWING1
(Ellipse Matte White Fitting & White Interior)

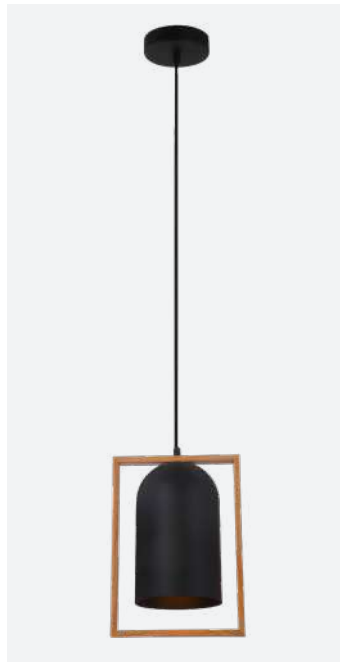

SWING2
(Ellipse Matte Black Fitting & Black Interior)



SWING3
(Dome Matte White Fitting & White Interior)

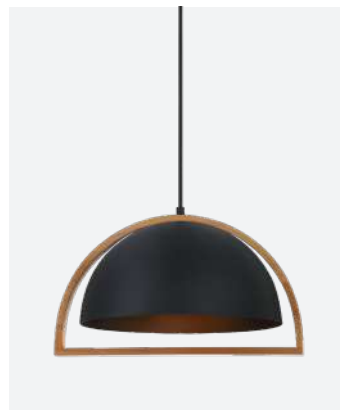

SWING4
(Dome Matte Black Fitting & Black Interior)



SWING5
(Ellipse Matte White Fitting & White Interior)



SWING6
(Ellipse Matte Black Fitting & Black Interior)

- Interior iron with wood frame pendant lights
- Shade: powder coated iron and wood
- Globe not included
- For indoor use only



Part No.	SWING1-6
Description	PENDANT Iron Oblong/ Dome/ Ellipse + Wood Frame
Material	Iron & wood
Lamp Holder	1xE27 (Max.72W)
Dimensions	SWING1-2: W230 x H320mm SWING3-4: W370 x H215mm SWING5-6: W230 x H320mm
Suspension	3000mm PVC cable
Canopy Size	Ø110x20mm
Carton QTY	1/1

*SWING 1, 3, 5 Product images have a warm white light source 'ON'.

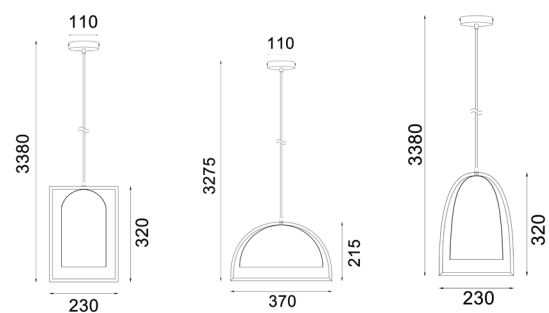

Nodric Interior Pendant Lights



NORDIC1 - Small
NORDIC3 - Medium
NORDIC5 - Large
(White)



NORDIC2 - Small
NORDIC4 - Medium
NORDIC6 - Large
(Black)

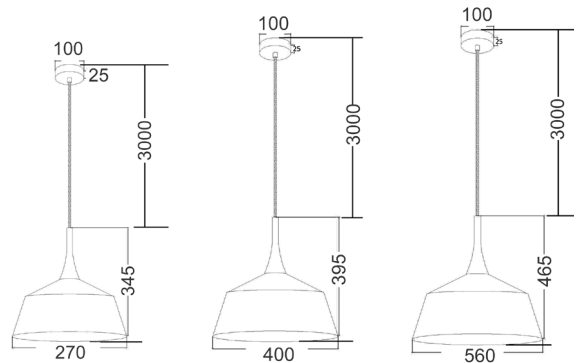

- Interior angled dome pendant lights
- Shade: iron & wood
- Shade interior colour: white
- Globe not included
- For indoor use only



Part No.	NORDIC1-6
Description	PENDANT Angled Dome with Blonde Wood + Round Canopy
Material	Powder coated steel & wood
Lamp Holder	1xE27 (Max.60W)
Dimensions	NORDIC1-2: Ø270 x H345mm NORDIC3-4: Ø400 x H395mm NORDIC5-6: Ø560 x H465mm
Suspension	NORDIC1, 3 & 5: 3000mm white and black strips textile cable NORDIC2, 4 & 6: 3000mm textile cable
Canopy Size	Ø100x25mm
Carton QTY	1/1



Horten Interior Pendant Lights

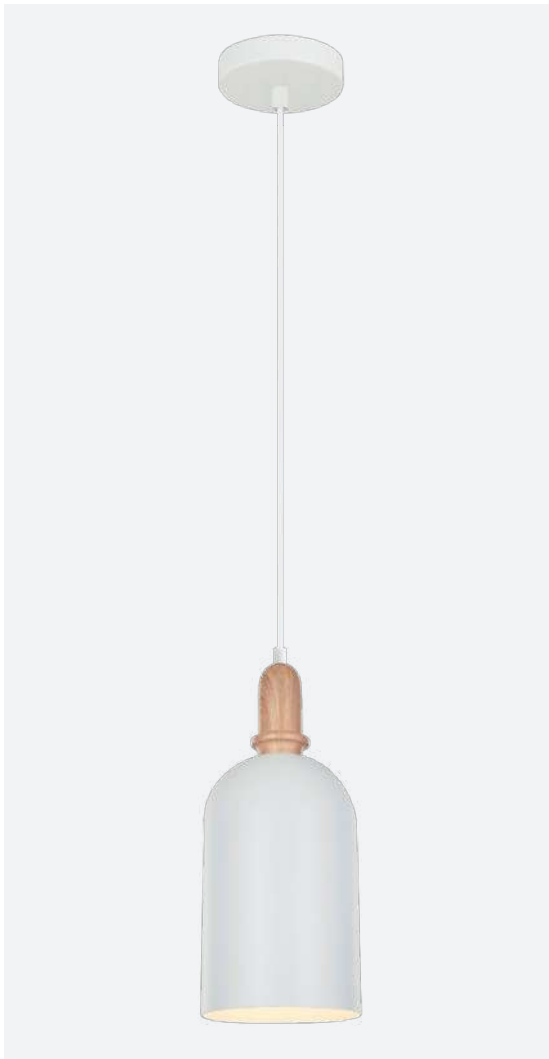

HORTEN1
(Matte White Fitting & White Interior)

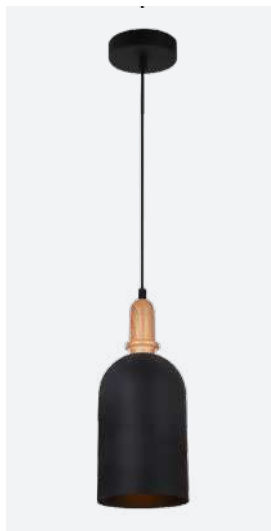

HORTEN2
(Matte Black Fitting & Black Interior)

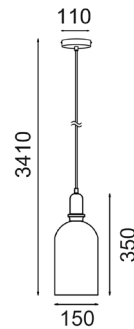

- Interior ellipse pendant lights
- Shade: powder coated iron
- Globe not included
- For indoor use only



Part No.	HORTEN1-2
Description	PENDANT Iron Ellipse with Blonde Wood + Round Canopy
Material	Powder coated iron
Lamp Holder	1xE27 (Max.72W)
Dimensions	Ø150 x H350mm
Suspension	3000mm cable
Canopy Size	Ø110mm
Carton QTY	1/10



Faro Interior Pendant Lights

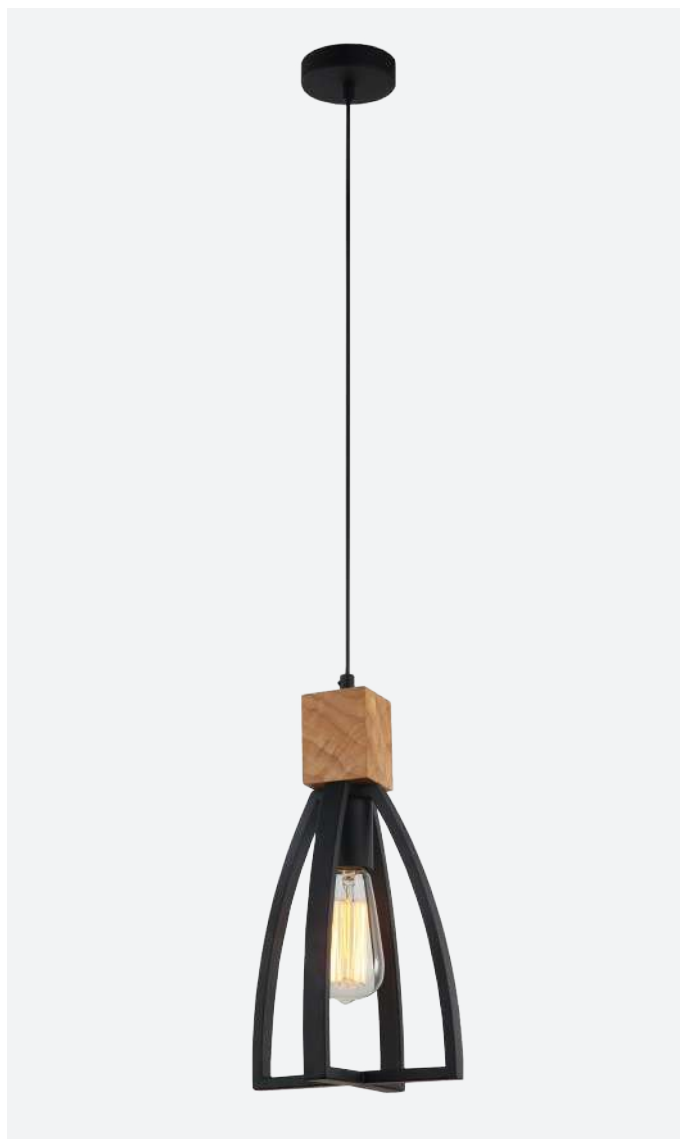

FARO1
(Matte Black)



FARO2
(Matte White)

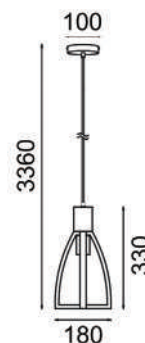

- Interior cone(convex) iron & wood pendant lights
- Shade: powder coated iron & wood
- Globe not included
- For indoor use only



Part No.	FARO1-2
Description	PENDANT Iron Cone (Concave) with Blonde Wood + Round Canopy
Material	Iron & wood
Lamp Holder	1xE27 (Max.72W)
Dimensions	Ø180xH330mm
Suspension	3000mm PVC cable
Canopy Size	Ø100x25mm
Carton QTY	1/10



DECOR LIGHTING

Lanterna Interior Pendant Lights

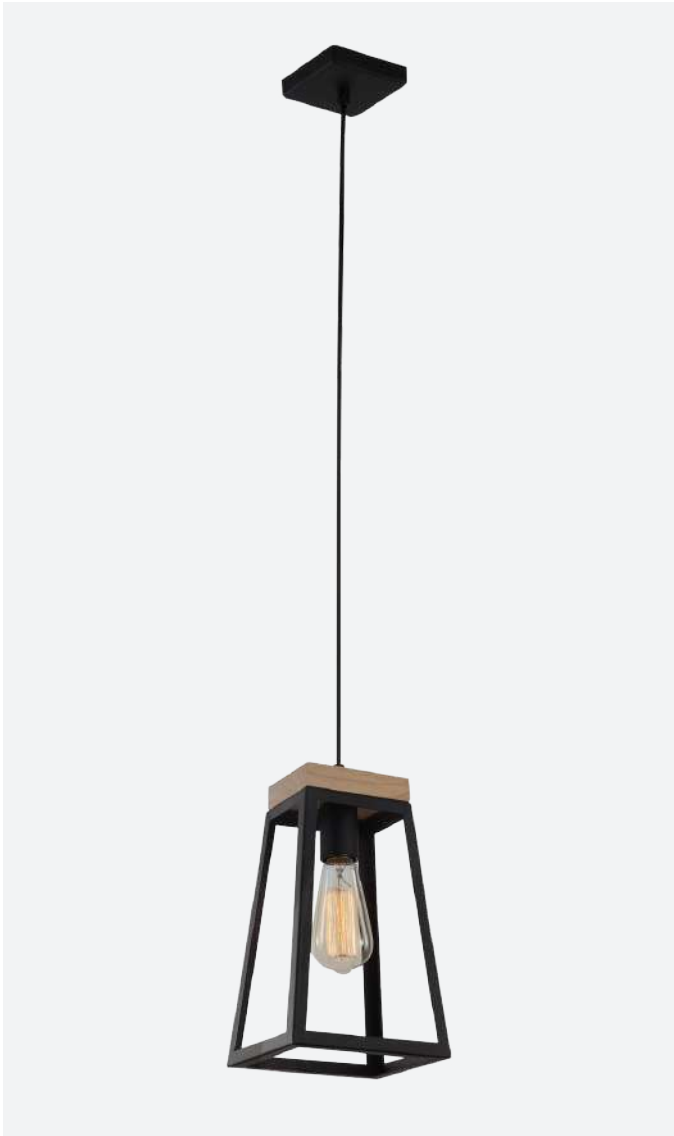

LANTERNA1
(Matte Black)

- Interior cone(square) iron wood pendant lights
- Shade: powder coated iron & wood
- Globe not included
- For indoor use only



Part No.	LANTERNA1-2
Description	PENDANT Cone (Square) with Blonde Wood + Square Canopy
Material	Iron & wood
Lamp Holder	1xE27 (Max.72W)
Dimensions	W170xH285mm
Suspension	3000mm PVC cable
Canopy Size	100x100x25mm
Carton QTY	1/10



LANTERNA2
(Matte White)

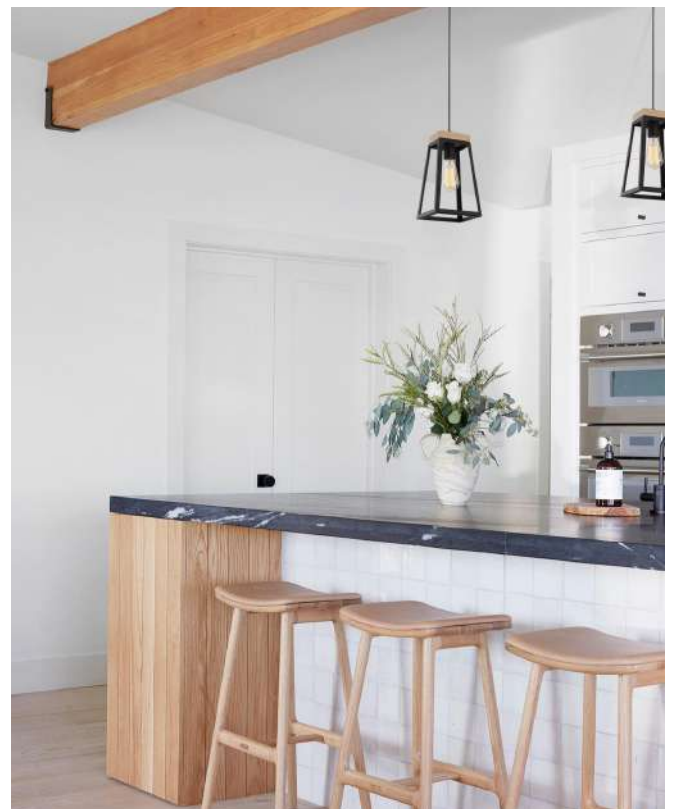
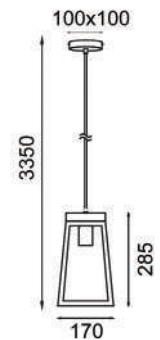

Ligna Interior Pendant Lights

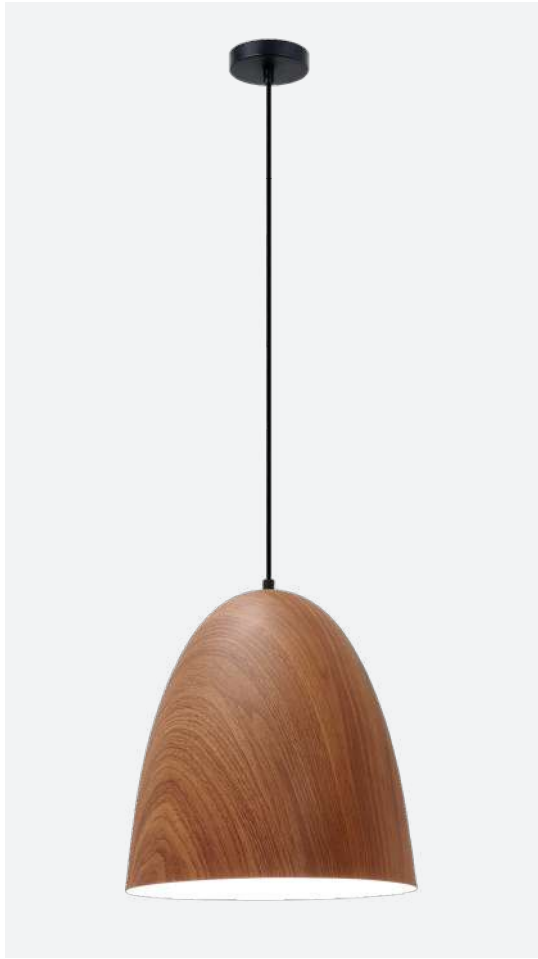

LIGNA01
(Painted Cherry Cinnamon)

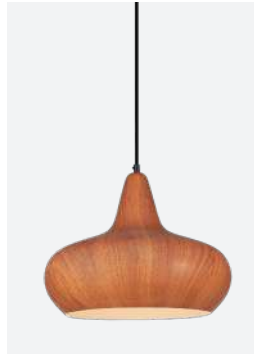

LIGNA04
(Painted Cherry Cinnamon)

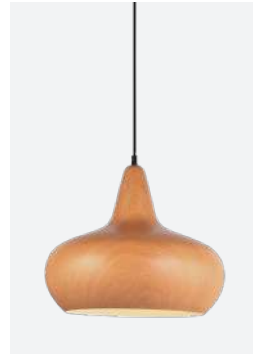

LIGNA05
(Painted Cherry Golden Oak)

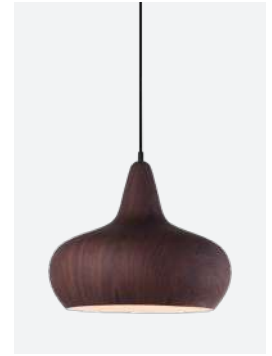

LIGNA06
(Painted Black Walnut)



LIGNA07
(Painted Cherry Cinnamon)

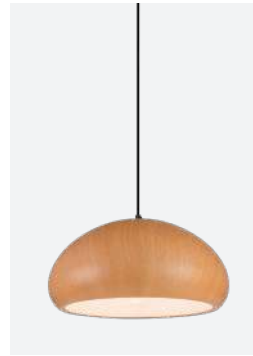

LIGNA08
(Painted Cherry Golden Oak)



LIGNA09
(Painted Black Walnut)



LIGNA02
(Painted Cherry Golden Oak)



LIGNA03
(Painted Black Walnut)

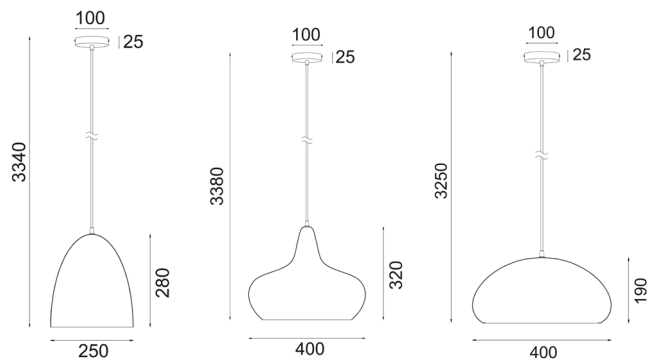

- Interior wood like pendant lights
- Shade: powder coated aluminium
- Shade interior colour: white
- Globe not included
- For indoor use only



Part No.	LIGNA01-09
Description	PENDANT ES 72W Ellipse/ Margarita Glass / Dome Painted + Round Black Canopy
Material	Aluminium
Lamp Holder	1xE27 (Max.72W)
Dimensions	LIGNA01-03: Ø250xH280mm LIGNA04-06: Ø400xH320mm LIGNA07-09: Ø400xH190mm
Suspension	3000mm PVC cable
Canopy Size	Ø100x25mm
Carton QTY	1/1



DECOR LIGHTING

Zara Interior Pendant Lights



ZARA1A
(Painted Oak Wood)



ZARA2A
(Painted Burl Wood)



ZARA3A
(Satin Nickel)

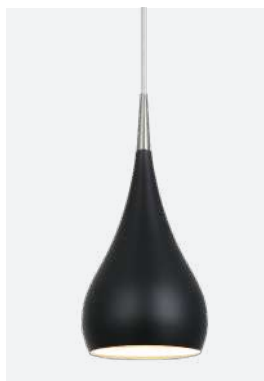

ZARA4A
(Black)



ZARA5A
(White)

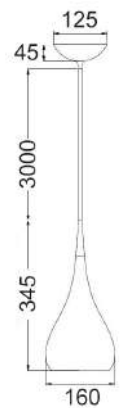

- Interior bell/ dome pendant lights
- Shade: powder coated steel
- Shade interior colour: white
- Globe not included
- For indoor use only



Part No.	ZARA1A-5A
Description	PENDANT Bell + S/Circular Nickel Canopy
Material	Steel
Lamp Holder	1xE27 (Max.60W)
Dimensions	Ø160xH345mm
Suspension	3000mm cable
Canopy Size	Ø125x45mm
Carton QTY	1/1





ZARA6A
(Painted Oak Wood)

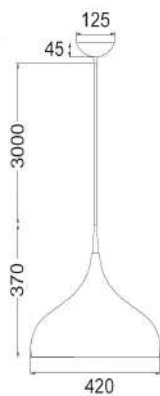

Part No.	ZARA6A-10A
Description	PENDANT Dome + S/Circular Nickel Canopy
Material	Steel
Lamp Holder	1xE27 (Max.60W)
Dimensions	Ø420xH370mm
Suspension	3000mm cable
Canopy Size	Ø125x45mm
Carton QTY	1/1



ZARA7A
(Painted Burl Wood)



ZARA8A
(Satin Nickel)



ZARA9A
(Black)



ZARA10A
(White)



Armis Interior Pendant Lights



ARMIS1
(Matte white)

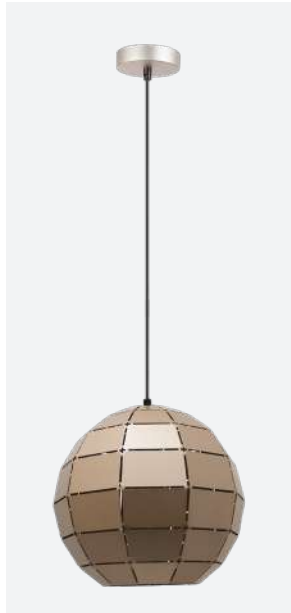

ARMIS2
(Champagne gold)

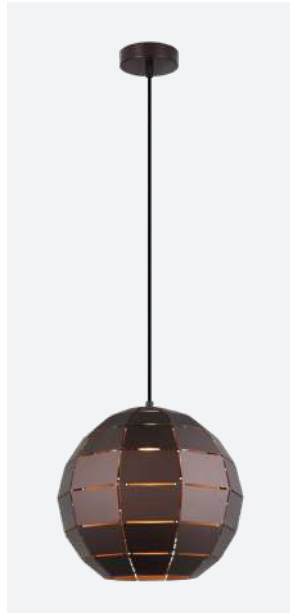

ARMIS3
(Coffee)

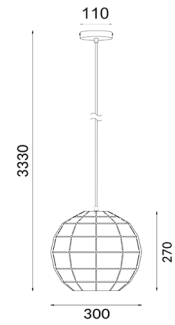

ARMIS4
(Matte white)



ARMIS5
(Champagne gold)



ARMIS6
(Coffee)

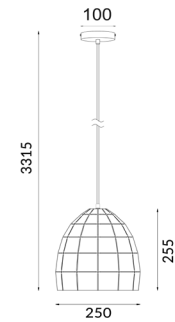

ARMIS7
(Matte white)



ARMIS8
(Champagne gold)



ARMIS9
(Coffee)

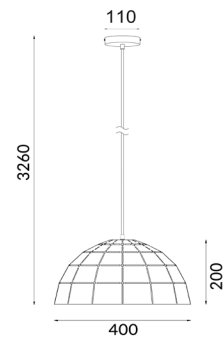

DECOR LIGHTING

- Interior iron with tiles pendant lights
- Shade: iron
- Globe not included
- For indoor use only



Part No.	ARMIS1-9
Description	PENDANT Iron with Tiles Wine glass/ Ellipse/ Dome
Material	Iron
Lamp Holder	1xE27 (Max.72W)
Dimensions	ARMIS1-3: Ø300xH270mm ARMIS4-6: Ø250xH255mm ARMIS7-9: Ø400xH200mm
Suspension	3000mm PVC cable
Canopy Size	ARMIS1-3: Ø110x25mm ARMIS4-6: Ø100x25mm ARMIS7-9: Ø110x25mm
Carton QTY	1/1



Finn Interior Pendant Lights



FINN1
(Long Cone)



FINN2
(Small Cone)



FINN3
(Medium Cone)

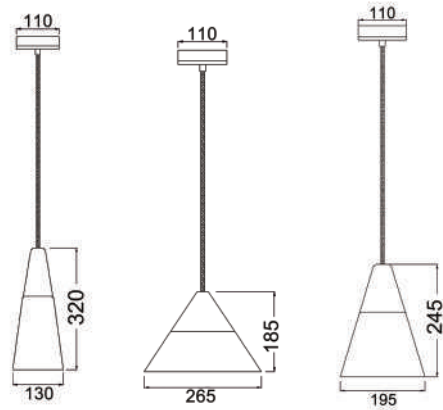

- Interior cone blonde wood opal glass pendant lights
- Shade: blonde wood & opal glass
- Globe not included
- For indoor use only



Part No.	FINN1-3		
Description	PENDANT Cone (Flat top) with Blonde Wood + Round Blonde Wood Canopy		
Material	Wood & opal glass		
Lamp Holder	1xE27 (Max.40W)		
Dimensions	FINN1: Ø130 x H320mm FINN2: Ø265 x H185mm FINN3: Ø195 x H245mm		
Suspension	3000mm black fabric wire cable		
Canopy Size	Ø110x25mm		
Carton QTY	FINN1: 1/4	FINN2: 1/2	FINN3: 1/4



Legna Interior Pendant Lights

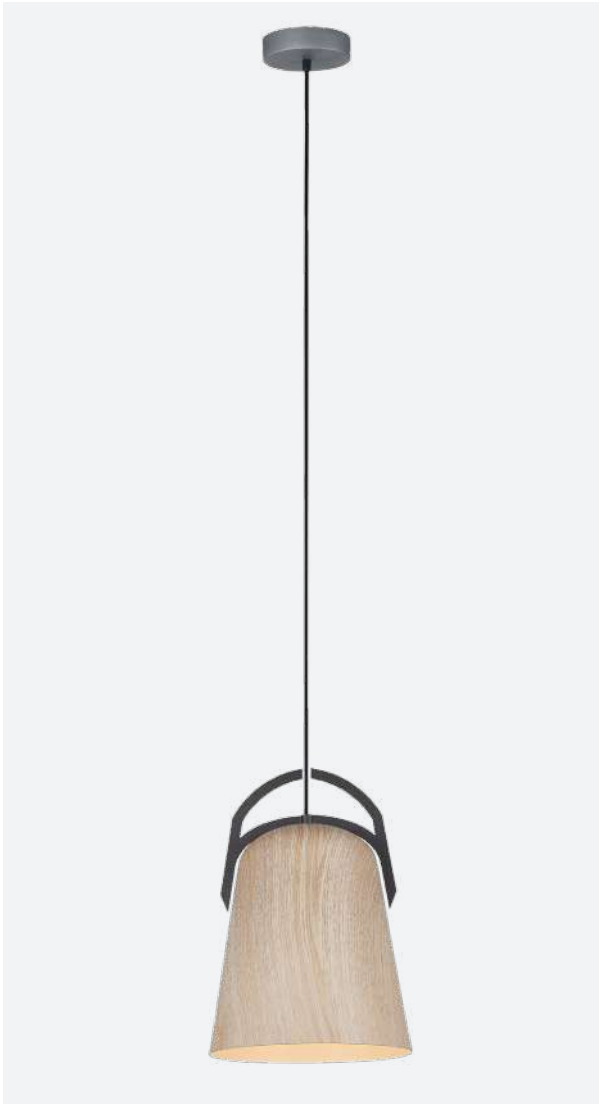

LEGNA1
(Painted Natural Oak)

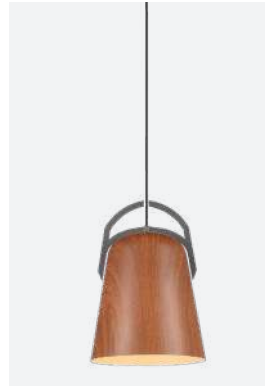

LEGNA3
(Painted Salem Oak)

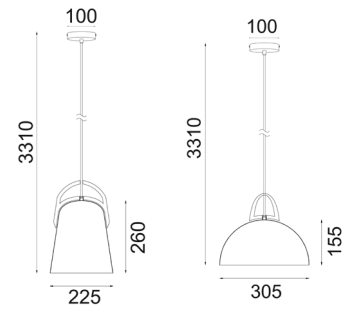

LEGNA2
(Painted Natural Oak)

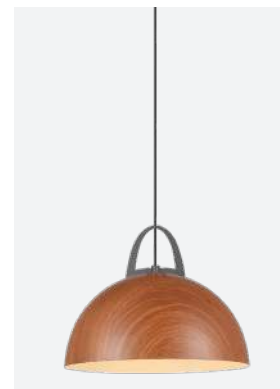

LEGNA4
(Painted Salem Oak)

- Interior ellipse / dome pendant lights
- Shade: aluminium
- Shade interior colour: white
- Globe not included
- For indoor use only



Part No.	LEGNA1-4
Description	PENDANT Ellipse/ Dome with Grey + Round Grey Canopy
Material	Aluminium
Lamp Holder	1xE27 (Max.72W)
Dimensions	LEGNA1 & 3: Ø225xH260mm LEGNA2 & 4: Ø305xH155mm
Suspension	3000mm PVC cable
Canopy Size	Ø100x25mm
Carton QTY	1/1



*Product images have a warm white light source 'ON'.

Celeste Interior Pendant Lights

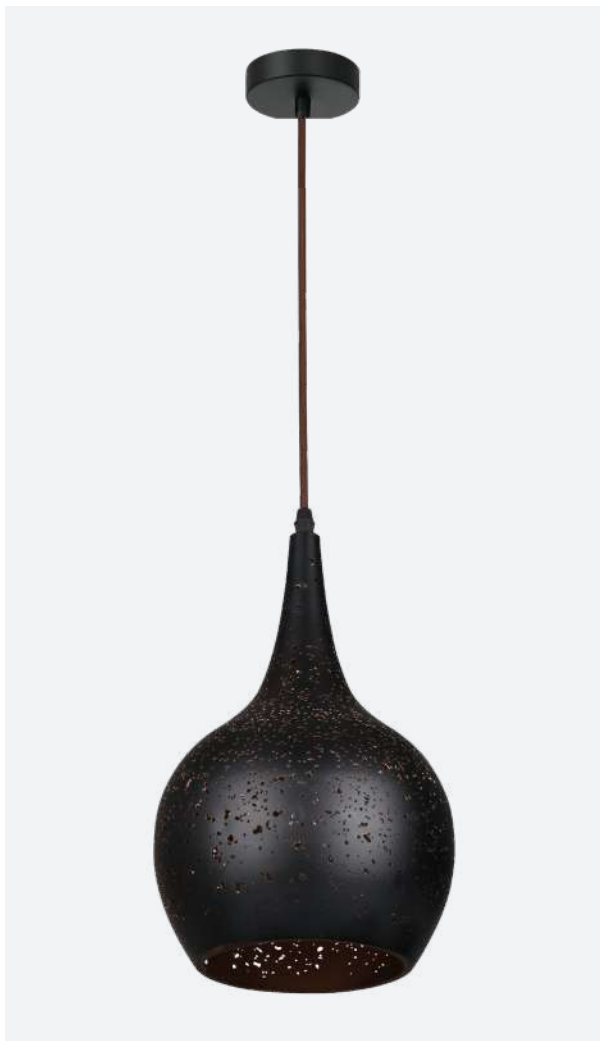

CELESTE1A
(Bell Shape)

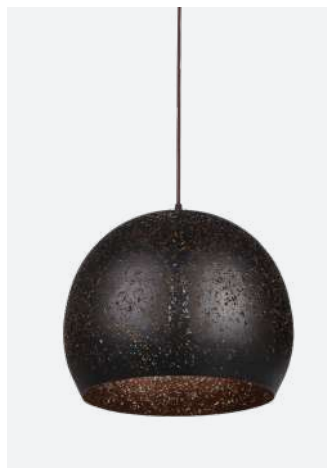

CELESTE2A
(Dome Shape)



CELESTE3A
(Ellipse Shape)

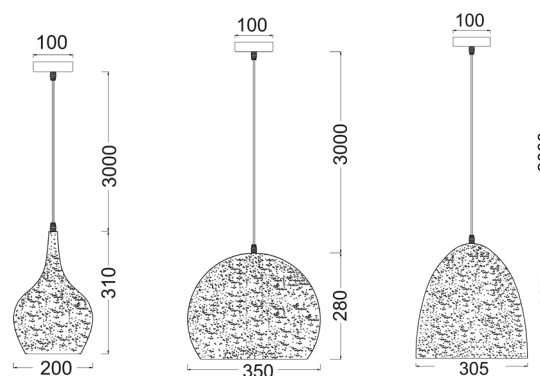

- Interior black speckled pendant lights
- Shade: powder coated aluminium
- Shade interior colour: gold
- Globe not included
- For indoor use only



Part No.	CELESTE1A-3A
Description	PENDANT ES 40W Bell/ Dome/ Ellipse Black Speckled with Gold Interior + Round Black Canopy
Material	Powder coated aluminium
Lamp Holder	1xE27 (Max.40W)
Dimensions	CELESTE1: Ø200xH310mm CELESTE2: Ø350xH280mm CELESTE3: Ø305xH305mm
Suspension	3000mm PVC cable
Canopy Size	Ø100mm
Carton QTY	1/1



Koper Interior Pendant Lights

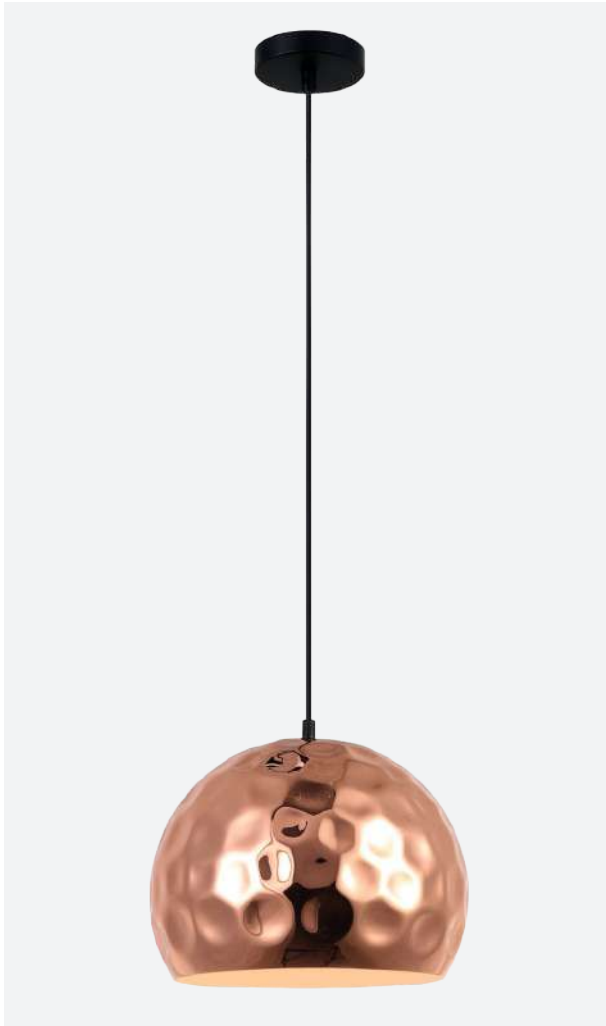

KOPER1
(Wine Glass Shape)

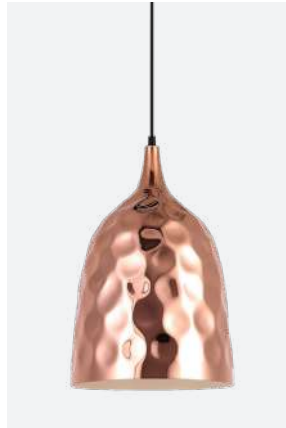

KOPER2
(Ellipse Shape)

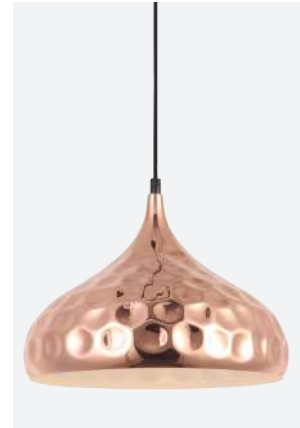

KOPER3
(Dome Shape)

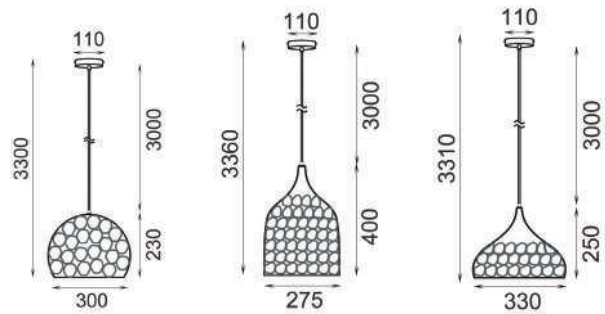

- Interior copper plated iron pendant lights
- Shade: copper plated iron
- Shade interior colour: white
- Globe not included
- For indoor use only



Part No.	KOPER1-3
Description	PENDANT ES 72W Copper Plated Dimpled with White Interior Wine Glass/ Ellipse/ Dome + Round Black Canopy
Material	Iron
Lamp Holder	1xE27 (Max.72W)
Dimensions	KOPER1: Ø300xH230mm KOPER2: Ø275xH400mm KOPER3: Ø330xH250mm
Suspension	3000mm PVC cable
Canopy Size	Ø110X25mm
Carton QTY	1/1



Modello Interior Pendant Lights



MODELLO1
(White)

- Interior cylinder perforated (horseshoes) pendant lights
- Shade: powder coated iron
- Globe not included
- For indoor use only



Part No.	MODELLO1-2
Description	PENDANT Cylinder Perforated (Horseshoes) + Round Canopy
Material	Powder coated iron
Lamp Holder	1xE27 (Max.72W)
Dimensions	Ø130xH250mm
Suspension	3000mm cable
Canopy Size	Ø100mm
Carton QTY	1/1



MODELLO2
(Black)

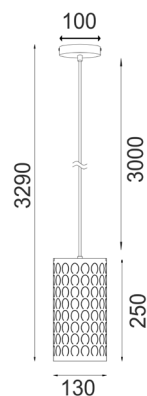

*Product images have a warm white light source 'ON'.

Rictus Interior Pendant Lights



RICTUS1
(Wine Glass Shape / Copper)

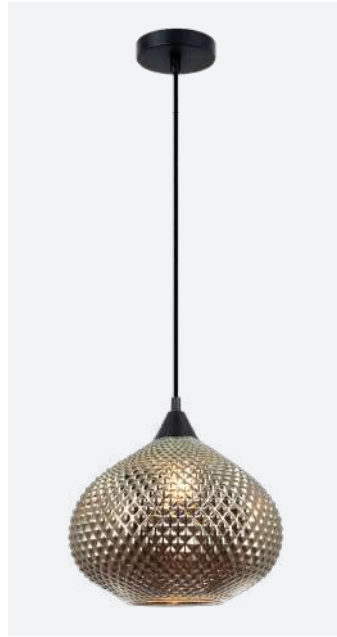

RICTUS2
(Wine Glass Shape / Chrome)

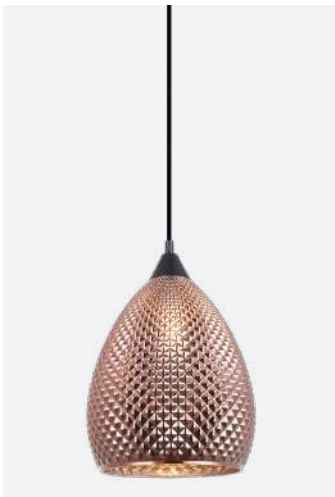

RICTUS3
(Ellipse Shape / Copper)



RICTUS4
(Ellipse Shape / Chrome)

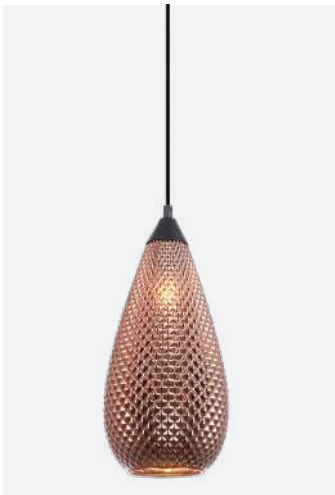

RICTUS5
(Tear Drop Shape / Copper)



RICTUS6
(Tear Drop Shape / Chrome)



- Interior peaked copper / chrome painted pendant lights
- Shade: glass
- Globe not included
- For indoor use only



Part No.	RICTUS1-6
Description	PENDANT Wine Glass/ Ellipse/ Tear Drop Peaked Copper/Chrome Painted Glass +RND BLK Canopy
Material	Glass
Lamp Holder	1xE27 (Max.72W)
Dimensions	RICTUS1-2: Ø290xH250mm RICTUS3-4: Ø225xH320mm RICTUS5-6: Ø180xH380mm
Suspension	3000mm cable
Canopy Size	RICTUS1-2: Ø110X25mm RICTUS3-6: Ø100X25mm
Carton QTY	1/1

*Product images have a warm white light source 'ON'.

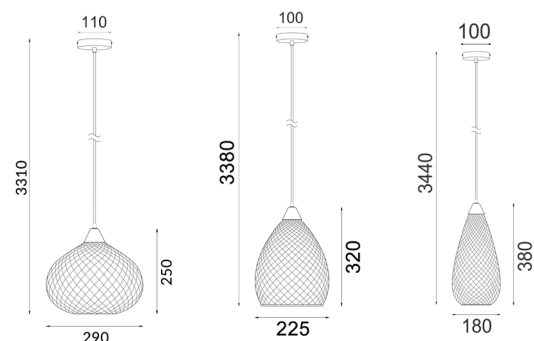

Glaze Interior Pendant Lights

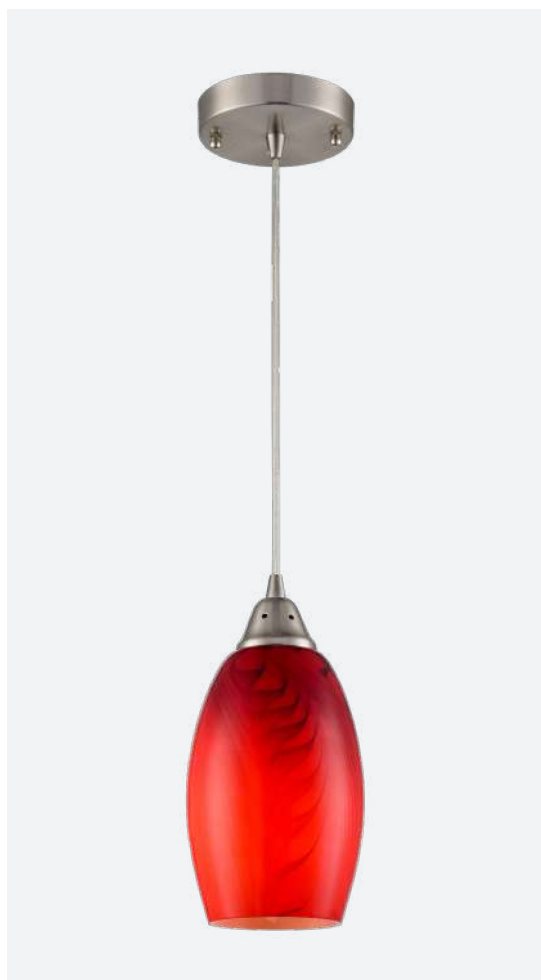

GLAZE1
(Red)



GLAZE2
(Green)



GLAZE3
(Blue)



GLAZE5
(Amber)

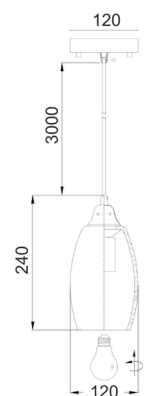

- Interior ellipse glass(Blown) feathered pendant lights
- Shade: satin nickel hardware with glass
- Globe not included
- For indoor use only



Part No.	GLAZE1-3 & GLAZE5
Description	PENDANT Ellipse Glass (Blown) Feathered + RND S/C Canopy
Material	Glass & iron
Lamp Holder	1xE27 (Max.60W)
Dimensions	Ø120xH240mm
Suspension	3000mm clear flex
Canopy Size	Ø120mm
Carton QTY	1/1

*Product images have a warm white light source 'ON'.





GLAZE10
(Dark & Light with Dark Infill)

- Interior stone mosaic glass pendant lights
- Shade: glass, stone & iron
- Globe not included
- For indoor use only



Part No.	GLAZE10-11
Description	PENDANT ES 60W Stone Mosaic Ellipse (Hand Blown Glass)
Material	Glass, stone & iron
Lamp Holder	1xE27 (Max.60W)
Dimensions	Ø136xH252mm
Suspension	3000mm cable
Canopy Size	Ø120x25mm
Carton QTY	1/1

*Product images have a warm white light source 'ON'.

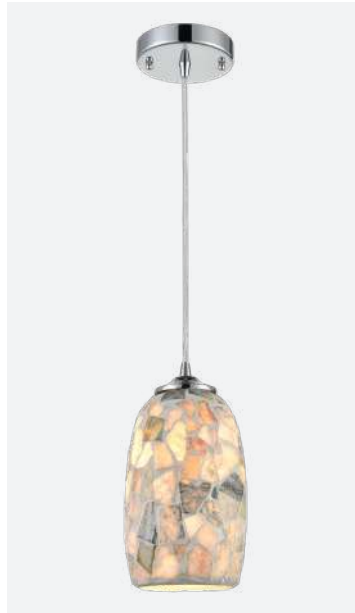

GLAZE11
(Dark & Light with Light Infill)

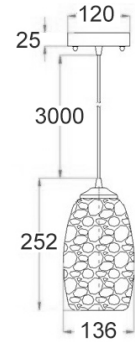

Ordito Interior Pendant Lights



ORDITO1
(Champagne Glass)



ORDITO2
(Black Chrome Glass)

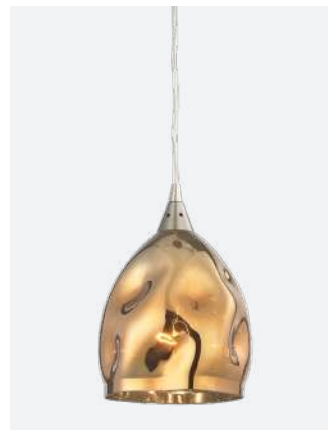

ORDITO3
(Gold Plated Glass)

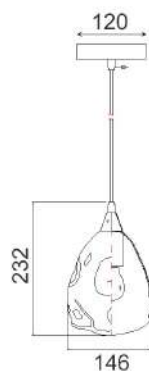

- Interior glass dimpled ellipse pendant lights
- Shade: chrome metal with glass
- Globe not included
- For indoor use only



Part No.	ORDITO1-3
Description	PENDANT ES 60W Glass Ellipse with Chrome Highlight + RND CH Canopy
Material	Glass, chrome metal
Lamp Holder	1xE27 (Max.60W)
Dimensions	Ø146xH232mm
Suspension	3000mm clear flex
Canopy Size	Ø120x25mm
Carton QTY	1/1

*Product images have a warm white light source 'ON'.



Chuva Interior Pendant Lights



CHUVA1
(Flat Top Ellipse Shape)



Rain drop effect



CHUVA2
(Wine Glass Shape)



CHUVA3
(Ellipse Shape)

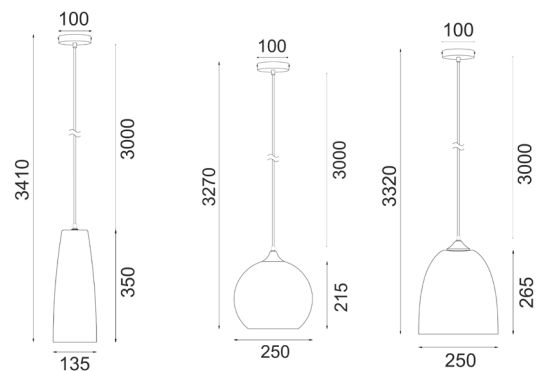

- Interior glass rain drop effect pendant lights
- Shade: glass & iron
- Globe not included
- For indoor use only



Part No.	CHUVA1-3
Description	PENDANT Smokey BLK Glass with Rain Drop Effect + RND BLK Canopy
Material	Glass & iron
Lamp Holder	1xE27 (Max.72W)
Dimensions	CHUVA1: Ø135xH350mm CHUVA2: Ø250xH215mm CHUVA3: Ø250xH265mm
Suspension	3000mm cable
Canopy Size	Ø100mm
Carton QTY	CHUVA1: 1/10 CHUVA2-3: 1/1



Mason Interior Pendant Lights



MASON1
(Amber)



MASON2
(Clear)



MASON3
(Smokey Black)



MASON4
(Amber)



MASON5
(Clear)



MASON6
(Smokey Black)

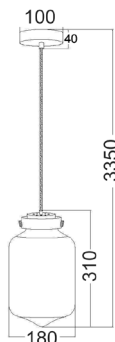

MASON7
(Amber)



MASON8
(Clear)



MASON9
(Smokey Black)

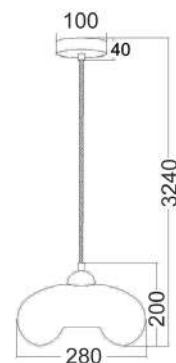

DECOR LIGHTING

- Interior glass pendant lights
- Shade: glass & iron
- Globe not included
- For indoor use only



Part No.	MASON1-9
Description	PENDANT Glass Cylinder/ Cylinder Tipped/ Oval with Black Highlight + RND BLK Canopy
Material	Glass & iron
Lamp Holder	1xE27 (Max.60W)
Dimensions	MASON1-3: Ø180xH360mm MASON4-6: Ø180xH310mm MASON7-9: Ø280xH200mm
Suspension	3000mm cable
Canopy Size	Ø100x40mm
Carton QTY	1/4



Casa Interior Pendant Lights



CASA1
(Cylinder Shape)



CASA2
(Wine Glass Shape)



CASA3
(Cylinder Shape)

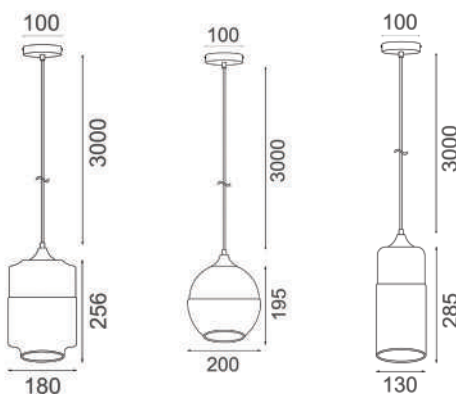

- Amber & matte white painted glass pendant lights
- Shade: amber glass (partially paint dipped)
- Globe not included
- For indoor use only



Part No.	CASA1-3
Description	PENDANT Amber & Matte White Painted Glass + RND BLK Canopy
Material	Glass
Lamp Holder	1xE27 (Max.72W)
Dimensions	CASA1: Ø180xH256mm CASA2: Ø200xH195mm CASA3: Ø130xH285mm
Suspension	3000mm cable
Canopy Size	Ø100mm
Carton QTY	1/1



*Product images have a warm white light source 'ON'.

Fumoso Interior Pendant Lights



FUMOSO1
(Cone Shape)

- Interior smokey black glass with copper painting pendant lights
- Shade: iron & glass
- Globe not included
- For indoor use only



Part No.	FUMOSO1-3
Description	PENDANT Smokey Glass with Copper Painting
Material	Iron & glass
Lamp Holder	1xE27 (Max.72W)
Dimensions	FUMOSO1: Ø180xH280mm FUMOSO2: Ø145xH300mm FUMOSO3: Ø250xH270mm
Suspension	3000mm cable
Canopy Size	Ø100mm
Carton QTY	1/1



FUMOSO2
(Ellipse Shape)



FUMOSO3
(Dome Shape)

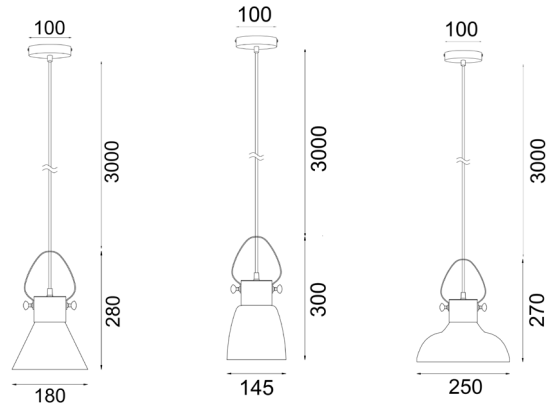

*Product images have a warm white light source 'ON'.

Lamina Interior Pendant Lights

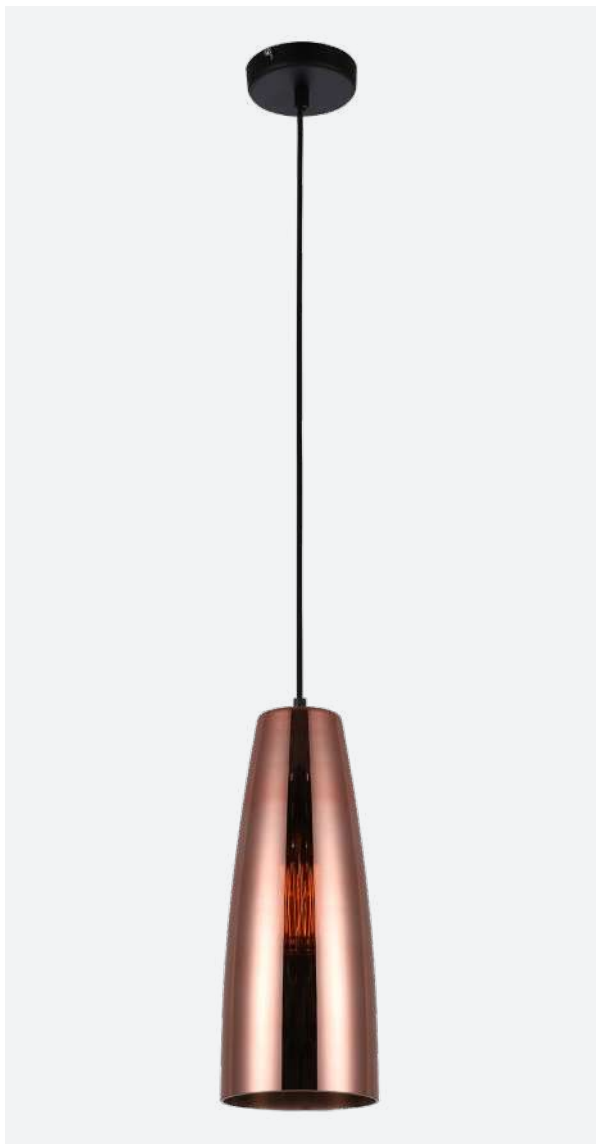

LAMINA1
(Ellipse Shape)

- Interior copper painted glass pendant lights
- Shade: glass
- Globe not included
- For indoor use only



Part No.	LAMINA1, LAMINA3, LAMINA4
Description	PENDANT ES 72W Copper Coloured Glass + RND BLK Canopy
Material	Glass
Lamp Holder	1xE27 (Max.72W)
Dimensions	LAMINA1: Ø135xH350mm LAMINA3: Ø170xH280mm LAMINA4: Ø280xH170mm
Suspension	3000mm black cable
Canopy Size	Ø100 x 25mm
Carton QTY	1/1

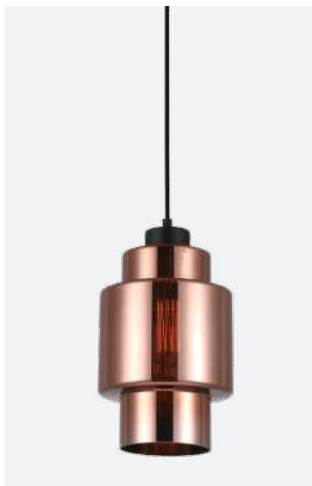

LAMINA3
(Double Cylinder Shape)

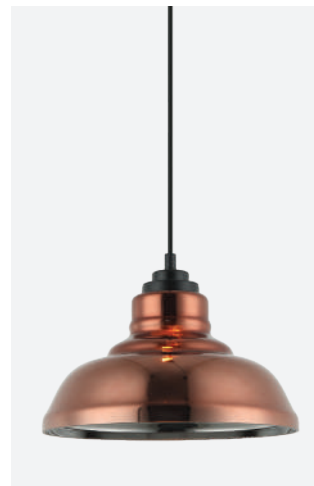

LAMINA4
(Dome Shape/ Chrome Interior)

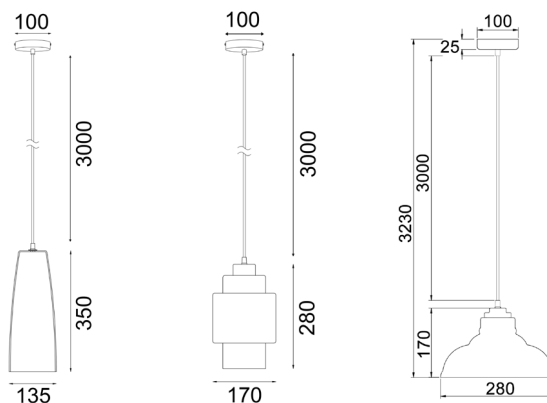

*Product images have a warm white light source 'ON'.

Tono Interior Pendant Lights



TONO1
(Clear Glass with Black Mesh)



TONO2
(Clear Glass with Copper Mesh)



TONO3
(Clear Glass with Brass Mesh)

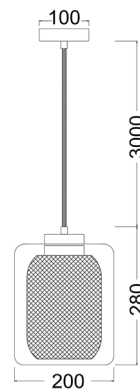

- Interior cylinder clear glass with mesh pendant lights
- Shade: glass
- Globe not included
- For indoor use only



Part No.	TONO1-3
Description	PENDANT Mesh Internal Cylinder (Dbl) Glass with Mesh + RND Canopy
Material	Powder coated iron & clear glass
Lamp Holder	1xE27 (Max.40W)
Dimensions	Ø200xH280mm
Suspension	3000mm cable
Canopy Size	Ø100mm
Carton QTY	1/4



Penola & Riverina Interior Pendant Lights

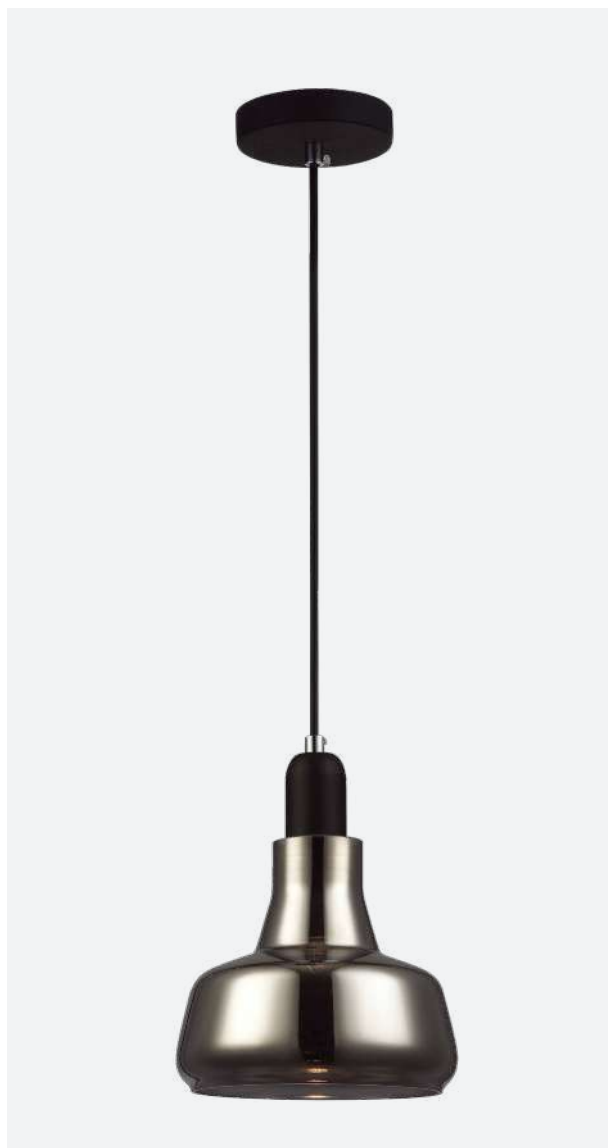

PENOLA
(Margarita Glass Shape)



RIVERINA
(Martini Glass Shape)

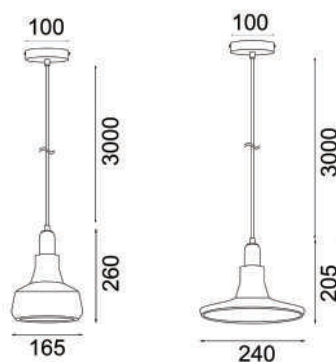

- Interior smokey black glass pendant lights
- Shade: glass
- Globe not included
- For indoor use only



Part No.	PENOLA & RIVERINA
Description	PENDANT Smokey Black Glass + RND BLK Canopy
Material	Glass
Lamp Holder	1xGU10 (Max.50W)
Dimensions	PENOLA: Ø165xH260mm RIVERINA: Ø240xH205mm
Suspension	3000mm cable
Canopy Size	Ø100mm
Carton QTY	1/10



Marte Interior Pendant Lights



MARTE1
(Black Iron Cage / Brass Highlight)

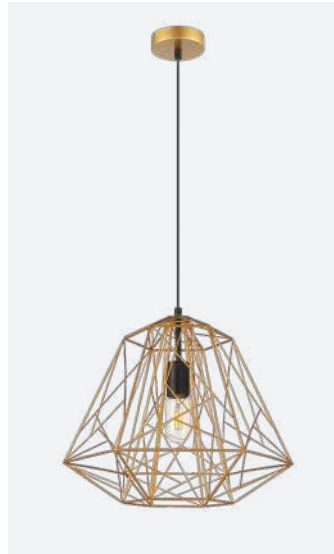

MARTE2
(Matte Gold Iron Cage / Black Highlight)



MARTE3
(White Iron Cage / Black Highlight)

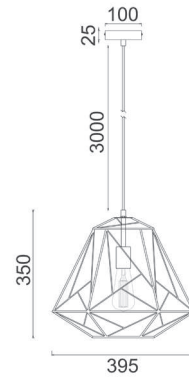

- Interior bell wire iron pendant lights
- Material: iron
- Globe not included
- For indoor use only



Part No.	MARTE1-3
Description	PENDANT ES 72W Iron Bell Wire With Highlight
Material	Iron
Lamp Holder	1xE27 (Max.72W)
Dimensions	Ø395 x H350mm
Suspension	3000mm cable
Canopy Size	Ø100 x 25mm
Carton QTY	1/1



Gamba Interior Pendant Lights



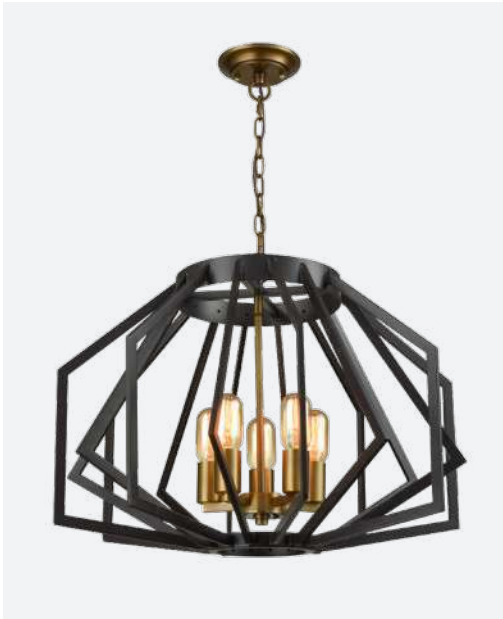

GAMBA1
(Antique Brass & Oiled Bronze)

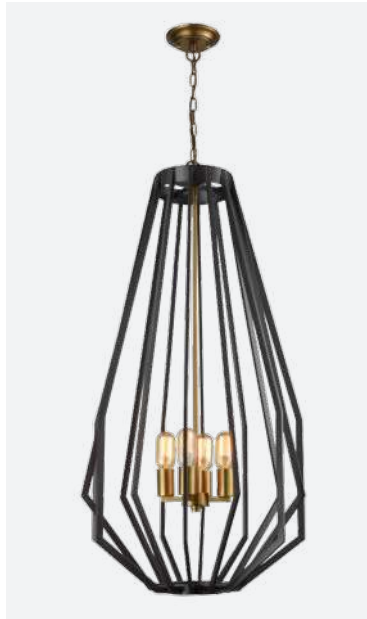

GAMBA2
(Antique Brass & Oiled Bronze)

- Interior angular cage pendant lights
- Shade: antique brass & oiled bronze/ white & polished nickel
- Globe not included
- For indoor use only

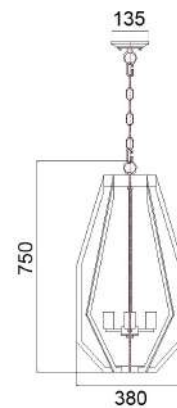
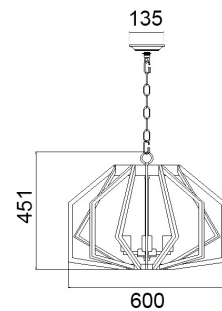

GAMBA3
(White & Polished Nickel)

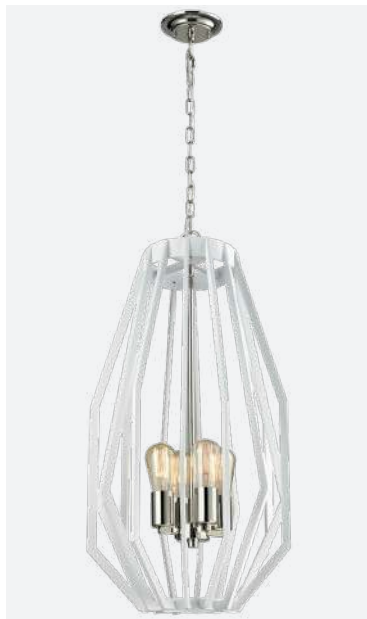

GAMBA4
(White & Polished Nickel)

Part No.	GAMBA1 & GAMBA3
Description	PENDANT ES x 5 60W Wide Antique Cage + RND Stepped Canopy
Material	Antique brass & oiled bronze / White & polished nickel
Lamp Holder	5xE27 (Max.60W)
Dimensions	Ø600xH451mm
Suspension	3000mm chain & cable
Canopy Size	Ø135mm
Carton QTY	1/1

Part No.	GAMBA2 & GAMBA4
Description	PENDANT ES x 4 60W Narrow Antique Cage + RND Stepped Canopy
Material	Antique brass & oiled bronze / White & polished nickel
Lamp Holder	4xE27 (Max.60W)
Dimensions	Ø380xH750mm
Suspension	3000mm chain & cable
Canopy Size	Ø135mm
Carton QTY	1/1





CHEVEUX1
(Ellipse)



CHEVEUX2
(Small Wine Glass Shape)



CHEVEUX3
(Bell Shape)

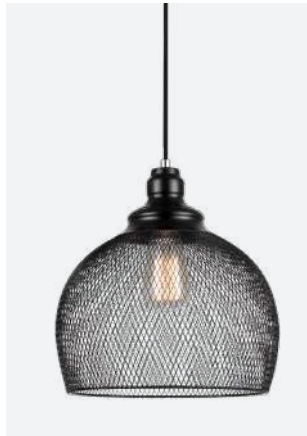

CHEVEUX4
(Large Wine Glass Shape)

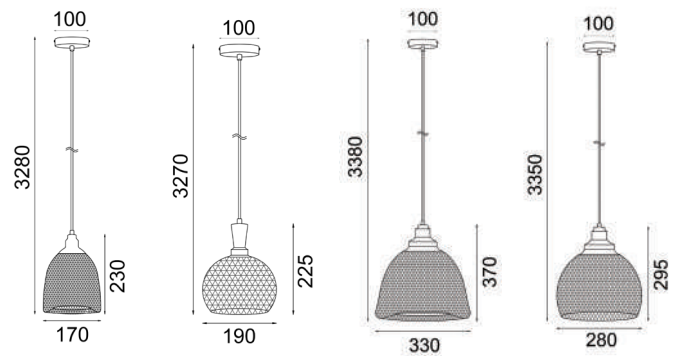

- Interior black mesh iron pendant lights
- Shade: powder coated iron
- Globe not included
- For indoor use only



Part No.	CHEVEUX1-4
Description	PENDANT ES 72W BLK Mesh Iron +RND BLK Canopy
Material	Iron
Lamp Holder	1xE27 (Max.72W)
Dimensions	CHEVEUX1: Ø170xH230mm CHEVEUX2: Ø190xH225mm CHEVEUX3: Ø330xH370mm CHEVEUX4: Ø280xH295mm
Suspension	3000mm cable
Canopy Size	Ø100mm
Carton QTY	CHEVEUX1: 1/10 CHEVEUX2-4: 1/1

Strand Interior Pendant Lights



STRAND1
(Black)



STRAND2
(White)



- Interior dome wire with Blonde Wood pendant lights
- Shade: powder coated iron & wood
- Globe not included
- For indoor use only



Part No.	STRAND1-2
Description	PENDANT ES 72W Iron Dome Wire with Blonde Wood +RND Canopy
Material	Iron & wood
Lamp Holder	1xE27 (Max.72W)
Dimensions	Ø400xH295mm
Suspension	3000mm cable
Canopy Size	Ø110x25mm
Carton QTY	1/1



Spiaggia Interior Pendant Lights

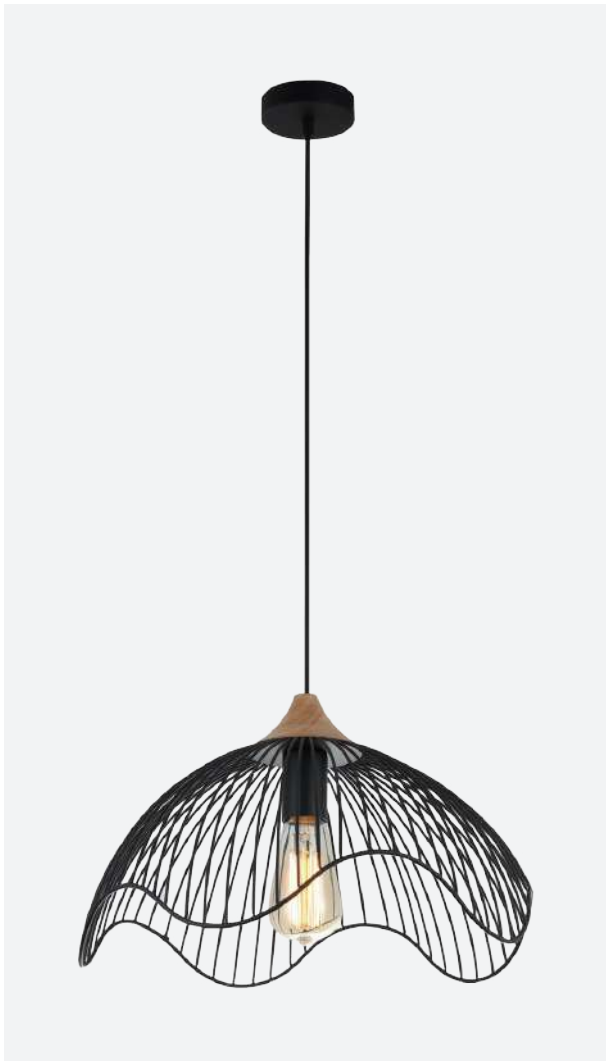

SPIAGGIA1
(Dome/ Black)

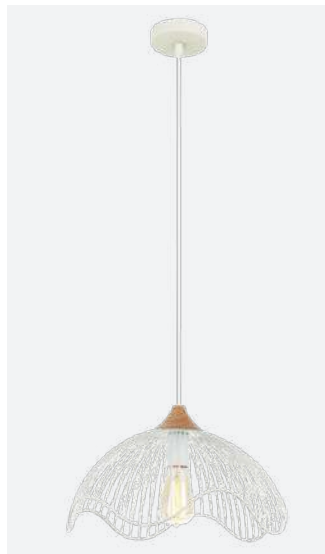

SPIAGGIA2
(Dome/ White)

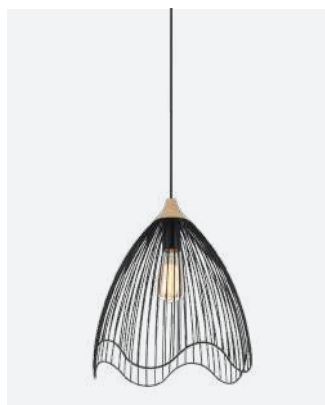
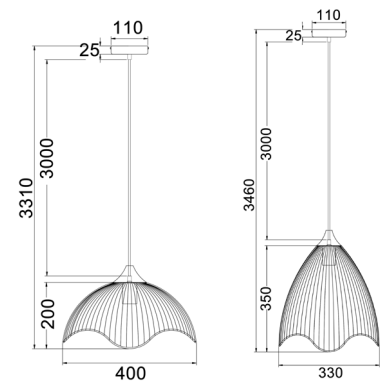

SPIAGGIA3
(Cone/ Black)



SPIAGGIA4
(Cone/ White)

- Interior wavy edge iron pendant lights
- Shade: powder coated iron & wood
- Globe not included
- For indoor use only



Part No.	SPIAGGIA1-4
Description	PENDANT ES 72W Iron Dome /Cone (Wavy Edge) w/Blonde Wood + RND Canopy
Material	Iron & wood
Lamp Holder	1xE27 (Max.72W)
Dimensions	SPIAGGIA1-2: Ø400xH250mm SPIAGGIA3-4: Ø330xH400mm
Suspension	3000mm cable
Canopy Size	Ø110x25mm
Carton QTY	1/1



Manu Interior Pendant Lights



MANU1
(Black)



MANU2
(White)

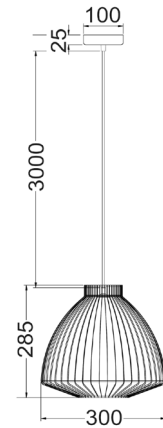

- Interior cone (concave) cage pendant lights
- Material: iron
- Globe not included
- For indoor use only



Part No.	MANU1-2
Description	PENDANT ES Cone (Concave) Wire Cage
Material	Iron
Lamp holder	1xE27 (Max.72W)
Dimensions	Ø300 x H285mm
Suspension	3000mm cable
Canopy size	Ø100 x 25mm
Carton QTY	1/1



Veneto Interior Pendant Lights



VENETO1X3BK

- Interior cylinder black mesh iron pendant lights
- Mesh shade can be removed
- Shade: iron
- Globe not included
- For indoor use only



Part No.	VENETO1BK & VENETO1X3BK
Description	PENDANT ES 72W Cylinder BLK Mesh Iron
Material	Iron
Lamp Holder	VENETO1BK: 1xE27 (Max.72W) VENETO1X3BK: 3xE27 (Max.72W)
Dimensions	VENETO1BK: Ø120xH230mm VENETO1X3BK: Ø320mm
Suspension	VENETO1BK: 3000mm cable VENETO1X3BK: 2.6m/ 2.8m/ 3m cable
Canopy Size	VENETO1BK: Ø100mm VENETO1X3BK: Ø300mm
Carton QTY	VENETO1BK: 1/10 VENETO1X3BK: 1/1



VENETO1BK

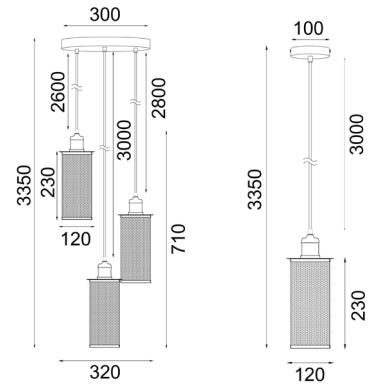

VENETO table lamps and interior wall lights are also available

Sentinel Interior Pendant Lights



SENTINEL1
(Matte Black)



SENTINEL2
(Matte White)

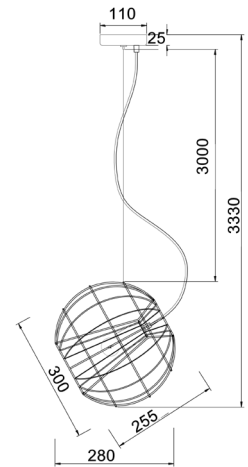

- Interior sphere wire iron with adjustable hanging angle pendant lights
- Shade: iron
- Globe not included
- For indoor use only



Part No.	SENTINEL1-2
Description	PENDANT ES 72W Sphere Wire with Adjustable Hanging Angle + RND Matte BLK Canopy
Material	Iron
Lamp Holder	1xE27 (Max.72W)
Dimensions	Ø300xH255mm
Suspension	3000mm cable
Canopy Size	Ø110x25mm
Carton QTY	1/1



Blackband & Whiteband Interior Pendant Lights





BLACKBAND1
(Cylinder Wire Cage)



BLACKBAND2
(Bell Wire Cage)



BLACKBAND3
(Cylinder Wire Cage)



BLACKBAND4
(Pear Wire Cage)

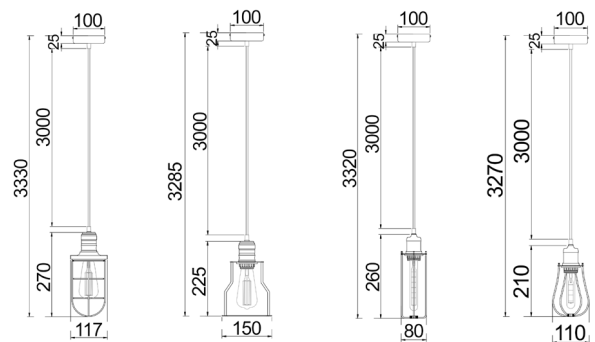

- Interior iron wire cage pendant lights
- Shade: powder coated iron
- Globe not included
- For indoor use only



GLOBE RESTRICTIONS (Max.globe dimensions):

BLACKBAND1: L135 x W60mm; BLACKBAND2: L N/A x W60mm;
BLACKBAND3: L180 x W30mm; BLACKBAND4: L130 x W30mm

Part No.	BLACKBAND1-4
Description	PENDANT ES 72W BLK Iron Wire Cage + RND BLK Canopy
Material	Iron
Lamp Holder	1xE27 (Max.72W)
Dimensions	BLACKBAND1: Ø117xH270mm BLACKBAND2: Ø150xH225mm BLACKBAND3: Ø80xH260mm BLACKBAND4: Ø110xH210mm
Suspension	3000mm cable
Canopy Size	Ø100mm
Carton QTY	1/1



BLACKBAND5
(Diamond Wire Cage)



BLACKBAND6
(Diamond Wire Cage)



WHITEBAND5
(Diamond Wire Cage)



WHITEBAND6
(Diamond Wire Cage)

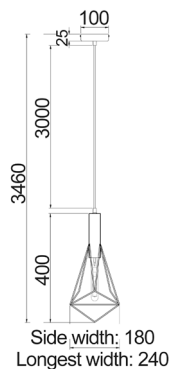
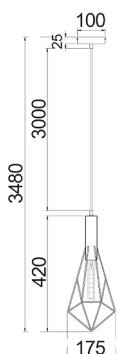

GLOBE RESTRICTIONS (Max.globe dimensions):

BLACKBAND5 & WHITEBAND5: L180 x W30mm;

BLACKBAND6 & WHITEBAND6: L180 x W30mm

Part No.	BLACKBAND5 & WHITEBAND5
Description	PENDANT ES 72W Iron Diamond Wire Cage + RND Canopy
Material	Iron
Lamp Holder	1xE27 (Max.72W)
Dimensions	175xH420mm
Suspension	3000mm cable
Canopy Size	Ø100x25mm
Carton QTY	1/1

Part No.	BLACKBAND6 & WHITEBAND6
Description	PENDANT ES 72W Iron Diamond Wire Cage + RND Canopy
Material	Iron
Lamp Holder	1xE27 (Max.72W)
Dimensions	240(Widest point)xH400mm
Suspension	3000mm cable
Canopy Size	Ø100x25mm
Carton QTY	1/1



BLACKBAND1X3



BLACKBAND2X3



WHITEBAND1X3



WHITEBAND2X3



GLOBE RESTRICTIONS (Max.globe dimensions):
 BLACKBAND1X3 & WHITEBAND1X3: L130 x W30mm;
 BLACKBAND2X3 & WHITEBAND2X3: L180 x W30mm

Part No.	BLACKBAND1X3 & WHITEBAND1X3
Description	PENDANT ESX3 72W Iron Diamond Wire Cage + Bar Base
Material	Iron
Lamp Holder	3xE27 (Max.72W)
Dimensions	W630xH380mm
Suspension	3000mm cable
Canopy Size	L550xW40xH20mm
Carton QTY	1/1

Part No.	BLACKBAND2X3 & WHITEBAND2X3
Description	PENDANT ESX3 72W Iron Diamond Wire Cage Varied + RND Base
Material	Iron
Lamp Holder	3xE27 (Max.72W)
Dimensions	Ø390xmm
Suspension	3000mm cable
Canopy Size	Ø300x25mm
Carton QTY	1/1

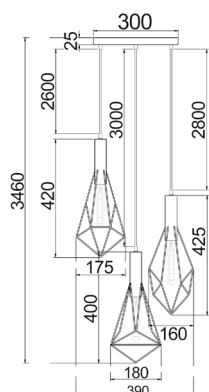
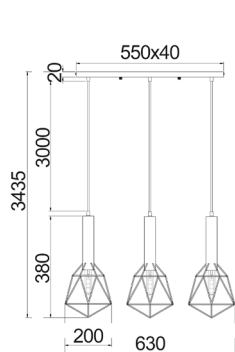

Matrix Interior Pendant Lights



MATRIX-B
(Black)



MATRIX-W
(White)

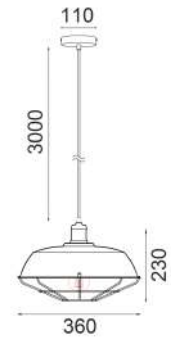

- Interior iron dome (angled) cage pendant lights
- Shade: powder coated iron
- Globe not included
- For indoor use only



Part No.	MATRIX-B, MATRIX-W
Description	PENDANT ES 72W Dome (Angled) Cage + RND Canopy
Material	Iron
Lamp Holder	1xE27 (Max.72W)
Dimensions	Ø360xH230mm
Suspension	3000mm cable
Canopy Size	Ø110mm
Carton QTY	1/1



Pastel Interior Pendant Lights



PASTEL01A
(Matte White)

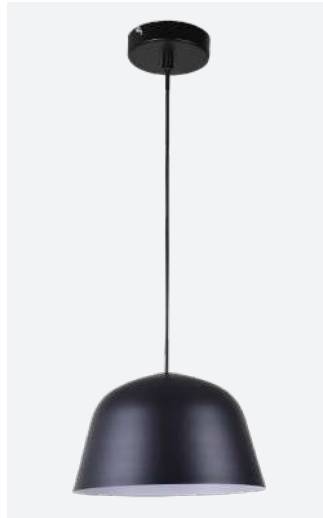

PASTEL02A
(Matte Black)



PASTEL03A
(Matte Pink)



PASTEL04A
(Matte Grey)

- Interior angled dome pendant lights
- Shade: powder coated iron
- Shade interior colour: white
- Globe not included
- For indoor use only



Part No.	PASTEL01A-07A
Description	PENDANT ES 40W Angled Dome + RND Canopy
Material	Iron
Lamp Holder	1xE27 (Max.40W)
Dimensions	Ø250xH155mm
Suspension	3000mm fabric cable
Canopy Size	Ø100mm
Carton QTY	1/1



PASTEL05A
(Matte Green)



PASTEL06A
(Matte Blue)

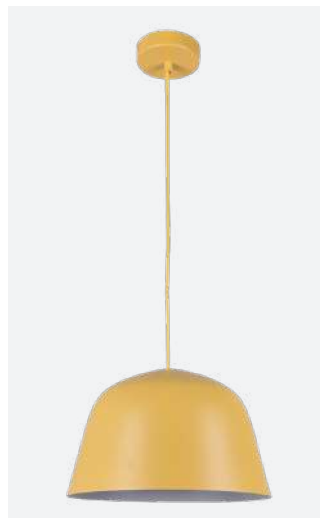

PASTEL07A
(Matte Yellow)

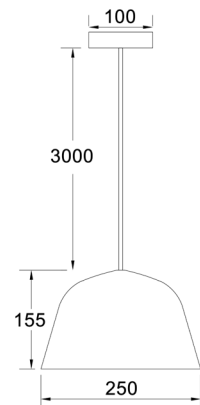



PASTEL08A
(Matte White)

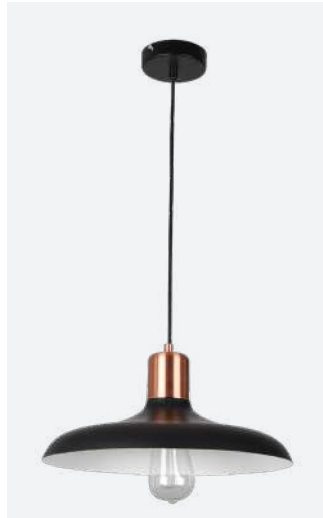

PASTEL09A
(Matte Black)

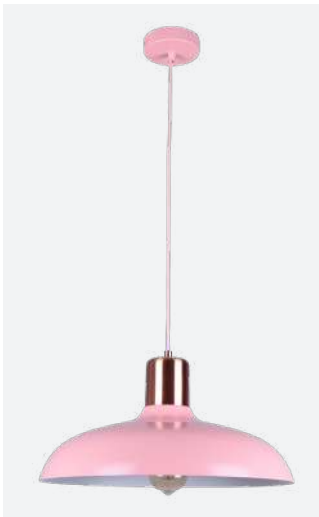

PASTEL10A
(Matte Pink)



PASTEL11A
(Matte Grey)

- Interior dome pendant lights
- Shade: powder coated iron
- Shade interior colour: white
- Globe not included
- For indoor use only



Part No.	PASTEL08A-14A
Description	PENDANT ES 40W Dome with Copper plating + RND Canopy
Material	Iron
Lamp Holder	1xE27 (Max.40W)
Dimensions	Ø400xH216mm
Suspension	3000mm fabric cable
Canopy Size	Ø100mm
Carton QTY	1/1



PASTEL112A
(Matte Green)



PASTEL13A
(Matte Blue)

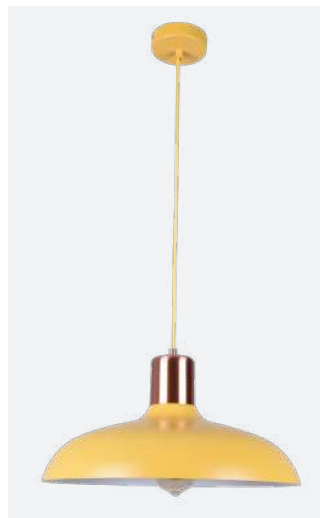

PASTEL14A
(Matte Yellow)

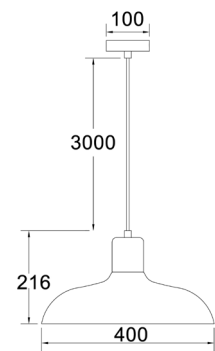

PASTEL table lamps & floor lamps are also available

Alta Interior Pendant Lights



ALTA1
(Matte White)

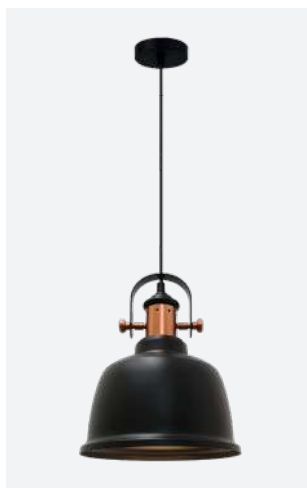

ALTA2
(Matte Black)



ALTA3
(Matte Grey)

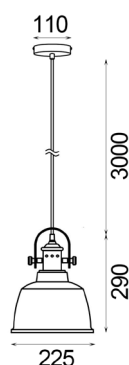

- Interior bell with copper plating pendant lights
- Shade: powder coated iron
- Globe not included
- For indoor use only



Part No.	ALTA1-3
Description	PENDANT ES 72W Bell with Copper Plating + RND Canopy
Material	Iron
Lamp Holder	1xE27 (Max.72W)
Dimensions	Ø225xH290mm
Suspension	3000mm cable
Canopy Size	Ø110mm
Carton QTY	1/1



*Product images have a warm white light source 'ON'.
*ALTA interior wall lights are also available.



Narvik Interior Pendant Lights

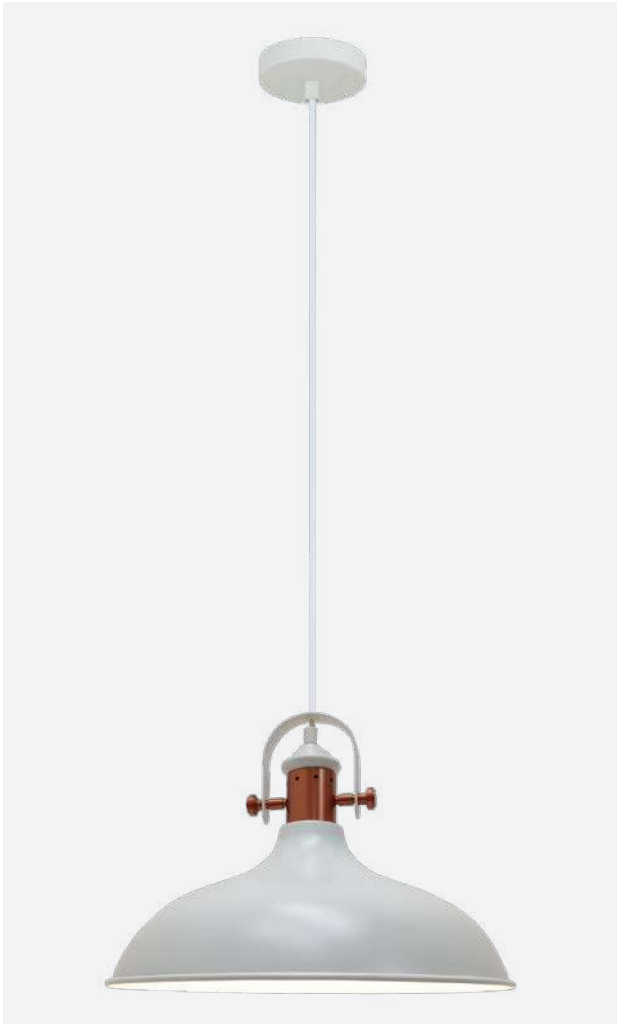

NARVIK1
(Matte White)

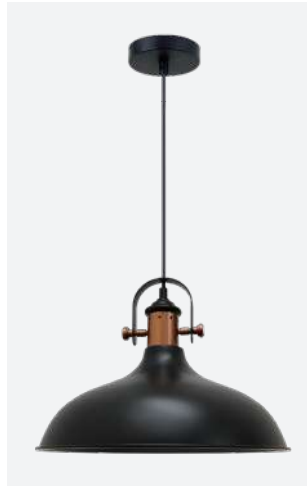

NARVIK2
(Matte Black)

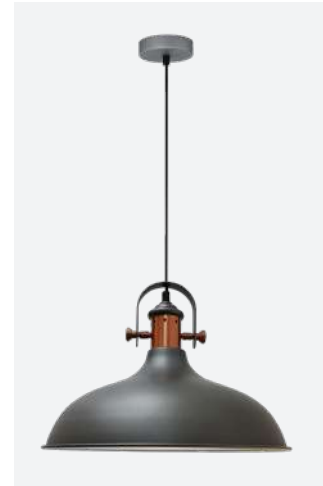

NARVIK3
(Matte Grey)

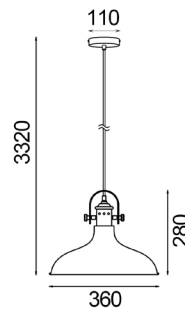

- Interior dome with copper plating pendant lights
- Shade: powder coated iron
- Globe not included
- For indoor use only



Part No.	NARVIK1-3
Description	PENDANT ES 72W Dome with Copper Plating
Material	Iron
Lamp Holder	1xE27 (Max.72W)
Dimensions	Ø360xH280mm
Suspension	3000mm cable
Canopy Size	Ø110mm
Carton QTY	1/5



Divo Interior Pendant Lights



DIVO1
(Antique Brass)



DIVO2
(Chrome)



DIVO3
(Satin Chrome)



DIVO4
(White)



DIVO5
(Black)



DIVO6
(Blue)

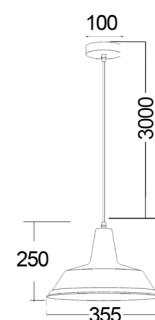

DIVO7
(Red)



DIVO8
(Green)



DIVO9
(Yellow)



DIVO10
(Orange)

DECOR LIGHTING



- Interior angled dome pendant lights
- Shade: powder coated steel
- Shade interior colour: white
- Globe not included
- For indoor use only



Part No.	DIVO1-10
Description	PENDANT ES 60W Angled Dome + RND Canopy
Material	Steel
Lamp Holder	1xE27 (Max.60W)
Dimensions	Ø355xH250mm
Suspension	3000mm cable
Canopy Size	Ø100mm
Carton QTY	1/1



Deksel Interior Pendant Lights

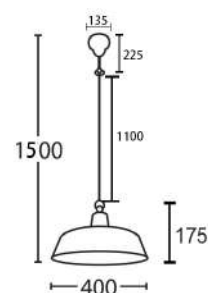

DEKSEL03
(Rustic Aged Copper)

- Interior angled dome aged copper pendant light
- Shade: aged oxidised solid copper
- Globe not included
- For indoor use only



Part No.	DEKSEL03
Description	PENDANT ES 60W Aged Copper (Brass Bracket & Base) + RND Tapered COP Canopy
Material	Copper
Lamp Holder	1xE27 (Max.60W)
Dimensions	Ø400xH175mm
Suspension	1100mm chain & cable
Canopy Size	Ø135x225mm
Carton QTY	1/4



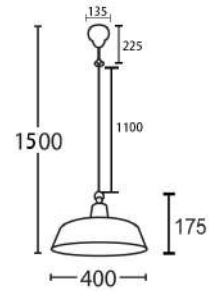
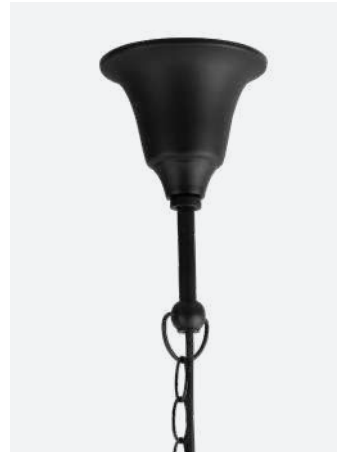

DEKSEL06
(Matte Black)

- Interior rustic matte black pendant light
- Shade: aluminium
- Globe not included
- For indoor use only



Part No.	DEKSEL06
Description	PENDANT ES 60W Matte Black Angled Dome
Material	Aluminium
Lamp Holder	1xE27 (Max.60W)
Dimensions	Ø400xH175mm
Suspension	1100mm chain & cable
Canopy Size	Ø135x225mm
Carton QTY	1/4

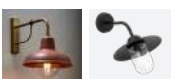

DEKSEL exterior wall light & interior wall light are also available



Caviar Interior Pendant Lights



CAVIAR4
(Trumpet shape)



CAVIAR5
(Angled Wine Glass Shape)

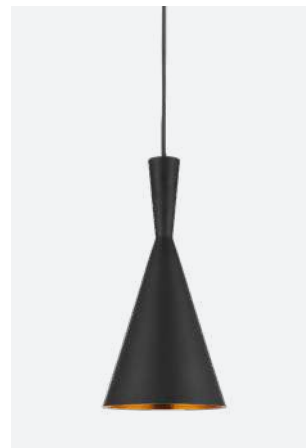

CAVIAR6
(Cone Shape)

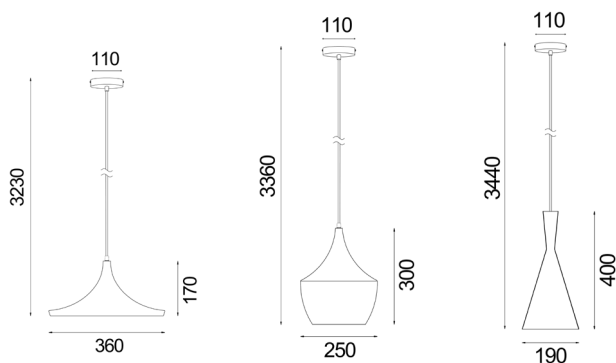

Gold Dimpled internal design

- Interior pendant lights
- Shade: powder coated aluminium
- Shade internal: dimpled design
- Shade interior colour: gold
- Globe not included
- For indoor use only



Part No.	CAVIAR4-5
Description	PENDANT ES 72W BLK with Gold Dimpled Internal + RND BLK Canopy
Material	Aluminium
Lamp Holder	1xE27 (Max.72W)
Dimensions	CAVIAR4: Ø360xH170mm CAVIAR5: Ø250xH300mm CAVIAR6: Ø190xH400mm
Suspension	3000mm PVC cable
Canopy Size	Ø110mm
Carton QTY	CAVIAR4-5: 1/1 CAVIAR6: 1/10



Classic Interior Pendant Lights



CLASSIC1A
(Red)



CLASSIC2A
(White)

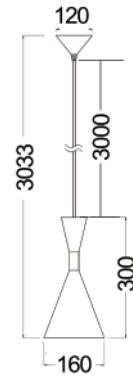

- Interior cone pendant lights
- Shade: powder coated aluminium
- Globe not included
- For indoor use only



Part No.	CLASSIC1A-2A
Description	PENDANT ES 40W Cone w/CH + RND Tapered Red Canopy
Material	Aluminium
Lamp Holder	1xE27 (Max.40W)
Dimensions	Ø160xH300mm
Suspension	3000mm PVC cable
Canopy Size	Ø120mm
Carton QTY	1/1



Piatto Interior Pendant Lights



PIATTO2
(Small Coolie)

PIATTO1
(Large Coolie)

- Interior coolie black pendant lights
- Shade: powder coated iron
- Globe not included
- For indoor use only



Part No.	PIATTO1-2
Description	PENDANT ES 72W BLK Coolie LGE/ SML + RND BLK Canopy
Material	Iron
Lamp Holder	1xE27 (Max.72W)
Dimensions	PIATTO1: Ø360xH150mm PIATTO2: Ø260xH150mm
Suspension	3000mm cable
Canopy Size	Ø100mm
Carton QTY	PIATTO1: 1/5 PIATTO2: 1/10

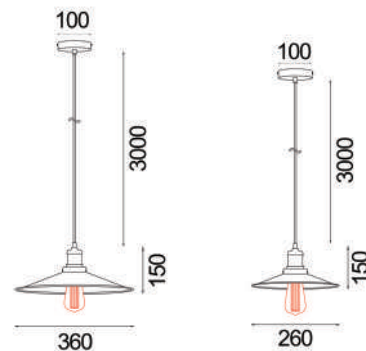

Pen Interior Pendant Lights



PEN2
(White)



PEN3
(Black)



- Interior pendant light suspensions
- Shade: silicone
- Globe not included
- For indoor use only



Part No.	PEN2 & PEN3
Description	PENDANT ES 60W Suspension + RND Tapered Silicon Canopy
Material	Silicone
Lamp Holder	1xE27 (Max.60W)
Dimensions	Ø40xH95mm
Suspension	3000mm cable
Canopy Size	Ø120mm
Carton QTY	1/20



Cluster Interior Pendant Lights



CLUSTER1
(White)



CLUSTER2
(Black)



CLUSTER3
(White)

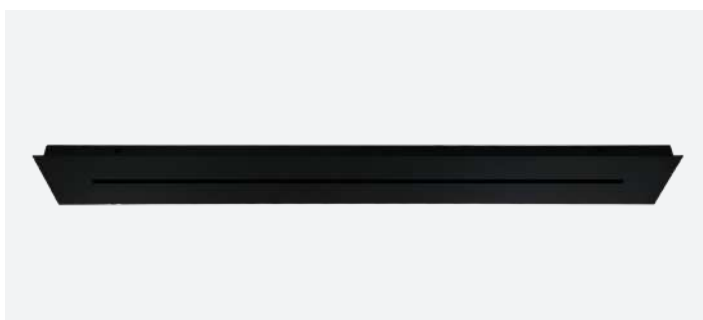

CLUSTER4
(Black)



- Cluster pendant canopies
- Available in 2 designs: Round (Max.6 lights) & Rectangular (Max.11 lights)
- Colour: Matt black / matt white
- Material: iron
- Surface mounted (Mounting bracket included)

IP20
Rated

1 YEAR
Replacement
Warranty

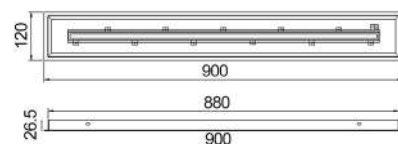
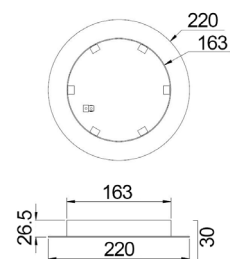

Part No.	Description	Dimensions	Carton QTY
CLUSTER1	RND Surface Mounted Cluster Canopy 6 Lights White	Ø220x26.5mm	1/10
CLUSTER2	RND Surface Mounted Cluster Canopy 6 Lights Black	Ø220x26.5mm	1/10
CLUSTER3	RECT Surface Mounted Cluster Canopy 11 Lights White	900x120x26.5mm	1/10
CLUSTER4	RECT Surface Mounted Cluster Canopy 11 Lights Black	900x120x26.5mm	1/10



DECOR LIGHTING

Ceiling Spot Lights



Spot Ceiling Spot Lights



SPOT-R1B



SPOT-S1B



SPOT-R3B



SPOT-BAR2B



SPOT-BAR3B



SPOT-BAR4B

- Input voltage: 100-240V AC 50/60Hz
- Housing: powder coated aluminium
- Mounting plate: iron
- 180° Tilt / 328° swivel
- Lamp holder: GU10 (Max.50W)
- Globe not included
- Globe grabber/ suction cap included

 GU10	IP20 Rated	2YEAR Replacement Warranty
---	----------------------	---

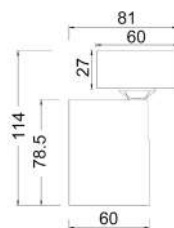

SPOT-R1B

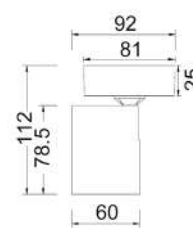

SPOT-S1B

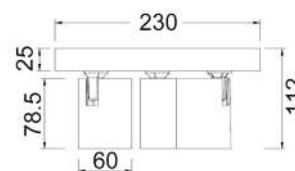

SPOT-R3B

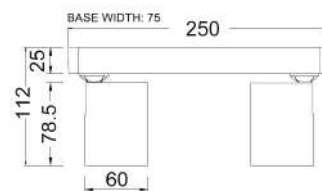

SPOT-BAR2B

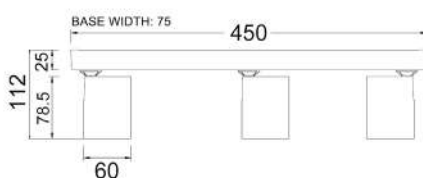

SPOT-BAR3B

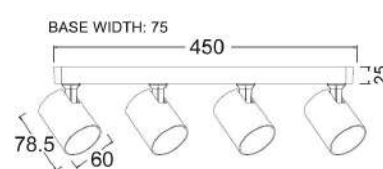

SPOT-BAR4B



SPOT-R1W



SPOT-S1W



SPOT-R3W



SPOT-BAR2W



SPOT-BAR3W



SPOT-BAR4W

Part No.	Description	Base	Carton QTY
SPOT-S1B	SPOT GU10 1 LIGHT/ADJ SQ BASE BLK	L81xW81xH25mm	1/50
SPOT-R1B	SPOT GU10 1 LIGHT/ADJ RND BASE BLK	Ø60xH27mm	1/50
SPOT-R3B	SPOT GU10 3 LIGHT/ADJ RND BASE BLK	Ø230xH25mm	1/8
SPOT-BAR2B	SPOT GU10 2 LIGHT/ADJ BAR BLK	L250xW75xH25mm	1/12
SPOT-BAR3B	SPOT GU10 3 LIGHT/ADJ BAR BLK	L450xW75xH25mm	1/8
SPOT-BAR4B	SPOT GU10 4 LIGHT/ADJ BAR BLK	L450xW75xH25mm	1/8
SPOT-S1W	SPOT GU10 1 LIGHT/ADJ SQ BASE WH	L81xW81xH25mm	1/50
SPOT-R1W	SPOT GU10 1 LIGHT/ADJ RND BASE WH	Ø60xH27mm	1/50
SPOT-R3W	SPOT GU10 3 LIGHT/ADJ RND BASE WH	Ø230xH25mm	1/8
SPOT-BAR2W	SPOT GU10 2 LIGHT/ADJ BAR WH	L250xW75xH25mm	1/12
SPOT-BAR3W	SPOT GU10 3 LIGHT/ADJ BAR WH	L450xW75xH25mm	1/8
SPOT-BAR4W	SPOT GU10 4 LIGHT/ADJ BAR WH	L450xW75xH25mm	1/8

Tache Ceiling Spot Lights



TACHE1
(3XGU10)



TACHE2
(4XGU10)



TACHE3
(6XGU10)

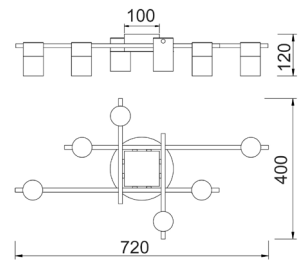
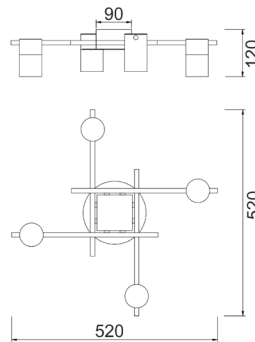
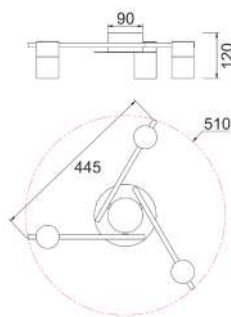

- Interior spot ceiling lights
- Material: aluminium
- Globe not included
- For indoor use only
- Warning: Adjustable head but Maximum 15° either way. Adjusting more than the suggested angle will cause damage to the fitting



Part No.	TACHE1-3
Description	SPOT GU10 Interior Ceiling Lamp Adj Ant/Brs Head w/Brs Rnd Base
Material	Aluminium
Lamp holder	TACHE1: 3 x GU10 (Max.35W) TACHE2: 4 x GU10 (Max.35W) TACHE3: 6 x GU10 (Max.35W)
Dimensions	TACHE1: Ø510 x H120mm TACHE2: 520 x 520 x H120mm TACHE3: 720 x 400 x H120mm
Base	TACHE1-2: Ø160mm TACHE3: Ø180mm
Canopy	TACHE1: Ø90 x H45mm TACHE2: Ø90 x H45mm TACHE3: Ø100 x H45mm
Carton QTY	1/1





TACHE4
(3XGU10)



TACHE5
(4XGU10)



TACHE6
(6XGU10)

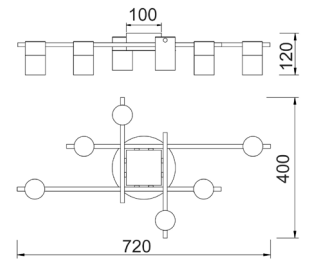
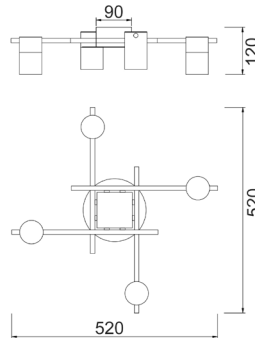
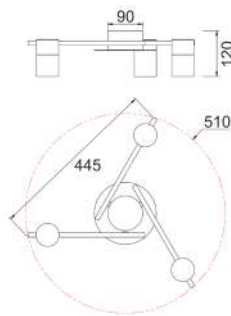

- Interior spot ceiling lights
- Material: aluminium
- Globe not included
- For indoor use only
- Warning: Adjustable head but Maximum 15° either way. Adjusting more than the suggested angle will cause damage to the fitting



Part No.	TACHE4-6
Description	SPOT GU10 Interior Ceiling Lamp Adj Blk & Ant/Brs Head w/Brs Rnd Base
Material	Aluminium
Lamp holder	TACHE4: 3 x GU10 (Max.35W) TACHE5: 4 x GU10 (Max.35W) TACHE6: 6 x GU10 (Max.35W)
Dimensions	TACHE4: Ø510 x H120mm TACHE5: 520 x 520 x H120mm TACHE6: 720 x 400 x H120mm
Base	TACHE4-5: Ø160mm TACHE6: Ø180mm
Canopy	TACHE4: Ø90 x H45mm TACHE5: Ø90 x H45mm TACHE6: Ø100 x H45mm
Carton QTY	1/1





TACHE7
(3XGU10)



TACHE8
(4XGU10)



TACHE9
(6XGU10)

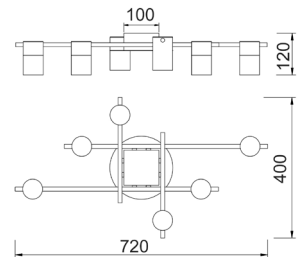
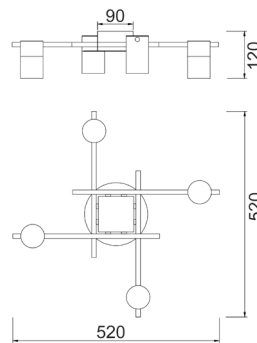
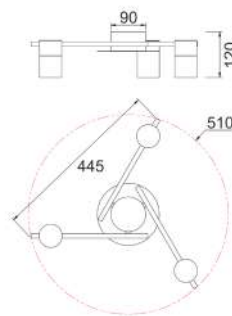

- Interior spot ceiling lights
- Material: aluminium
- Globe not included
- For indoor use only
- Warning: Adjustable head but Maximum 15° either way. Adjusting more than the suggested angle will cause damage to the fitting



Part No.	TACHE7-9
Description	SPOT GU10 Interior Ceiling Lamp Adj Chrome Head w/Chrome Rnd Base
Material	Aluminium
Lamp holder	TACHE7: 3 x GU10 (Max.35W) TACHE8: 4 x GU10 (Max.35W) TACHE9: 6 x GU10 (Max.35W)
Dimensions	TACHE7: Ø510 x H120mm TACHE8: 520 x 520 x H120mm TACHE9: 720 x 400 x H120mm
Base	TACHE7-8: Ø160mm TACHE9: Ø180mm
Canopy	TACHE7: Ø90 x H45mm TACHE8: Ø90 x H45mm TACHE9: Ø100 x H45mm
Carton QTY	1/1





TACHE10
(3XGU10)



TACHE11
(4XGU10)



TACHE12
(6XGU10)

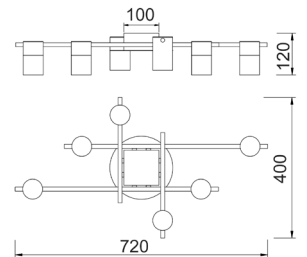
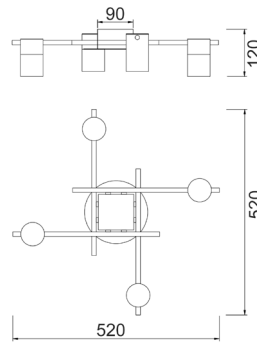
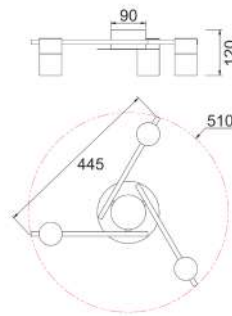

- Interior spot ceiling lights
- Material: aluminium
- Globe not included
- For indoor use only
- Warning: Adjustable head but Maximum 15° either way. Adjusting more than the suggested angle will cause damage to the fitting



Part No.	TACHE10-12
Description	SPOT GU10 Interior Ceiling Lamp Adj Black Head w/Black Rnd Base
Material	Aluminium
Lamp holder	TACHE10: 3 x GU10 (Max.35W) TACHE11: 4 x GU10 (Max.35W) TACHE12: 6 x GU10 (Max.35W)
Dimensions	TACHE10: Ø510 x H120mm TACHE11: 520 x 520 x H120mm TACHE12: 720 x 400 x H120mm
Base	TACHE10-11: Ø160mm TACHE12: Ø180mm
Canopy	TACHE10: Ø90 x H45mm TACHE11: Ø90 x H45mm TACHE12: Ø100 x H45mm
Carton QTY	1/1





TACHE13
(3XGU10)

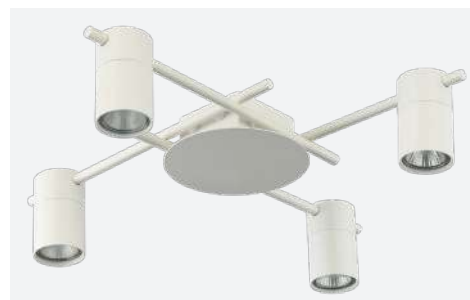

TACHE14
(4XGU10)



TACHE15
(6XGU10)

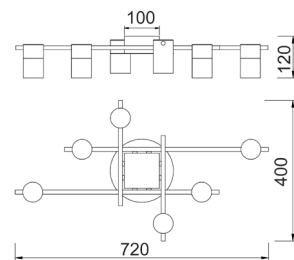
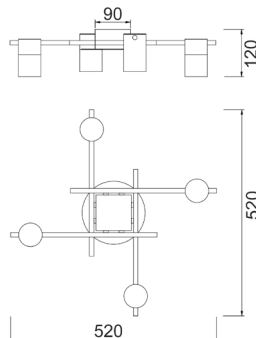
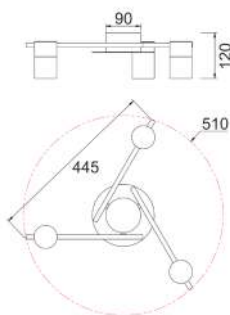

- Interior spot ceiling lights
- Material: aluminium
- Globe not included
- For indoor use only
- Warning: Adjustable head but Maximum 15° either way. Adjusting more than the suggested angle will cause damage to the fitting



Part No.	TACHE13-15
Description	SPOT GU10 Interior Ceiling Lamp Adj White Head w/white Rnd Base
Material	Aluminium
Lamp holder	TACHE13: 3 x GU10 (Max.35W) TACHE14: 4 x GU10 (Max.35W) TACHE15: 6 x GU10 (Max.35W)
Dimensions	TACHE13: Ø510 x H120mm TACHE14: 520 x 520 x H120mm TACHE15: 720 x 400 x H120mm
Base	TACHE13-14: Ø160mm TACHE15: Ø180mm
Canopy	TACHE13: Ø90 x H45mm TACHE14: Ø90 x H45mm TACHE15: Ø100 x H45mm
Carton QTY	1/1



DECOR LIGHTING

Table & Floor Lamps



Flatmate Table & Floor Lamps



- Eye Caring
- Tri-CCT and Dimmable
- USB Rechargeable, Adapter Included
- Adjustable lamp head

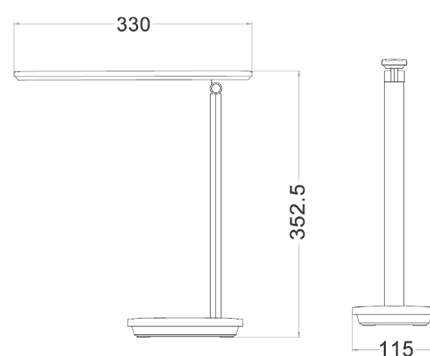

LED	24pcs SMD2835	Tri-CCT
Switch Form	Touch	
Switch Position	Short Press: Colour Temp Changes (3 modes): 3000K / 4000K / 5000K Long Press: Dimming from 100% to 0%	
Power Supply	5V DC 1A	
Power	5W (without adaptor)	
Lumens	300LM	
Battery Type	Lithium battery 18650	1800mAh
Charging Time	Approx 4 hours	When light is switched off
Continuous Lighting Time	2 hours (unplugged)	
RA	≥80	
IP Rating	IP20 for indoor use only	
USB Cable Length	(Type C) 1m	Note: USB port can be used to charge phone (Android only) but has to be plugged in when charging.
Size	W 330mm x D 115mm x H 352.5mm	
Weight	0.34kg	
Anti Slip Pad	0 to 40°C	
Ambient Temperature	-10 to 60°C	
Carton QTY	1/10	

Penmate Table & Floor Lamps



Desk Lamp: 5000K
Night Light: 3000K (3 Steps DIM for night light)

- Eye Caring
- Flexible Neck (360°)
- 3-Level Brightness (Night Light)
- USB Rechargeable, Adapter Included

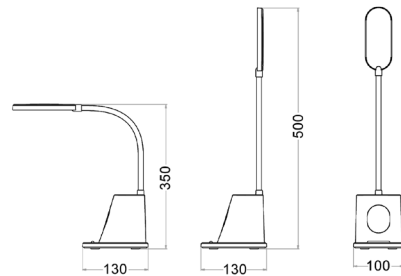

LED	Desk Lamp: 2pcs x SMD2835 LED Night Light: 4pcs x SMD2835 LED	Desk lamp: 5000K Night Light: 3000K
Switch Form	Touch	
Switch Position	Desk Lamp: Single touch one brightness Night Light: Single touch three brightness	Off / On Off/ Low/ Middle/ High Brightness
Power Supply	5V DC 1A	
Power	About 2.8W	
Lumens	Adapter Powered	Desk Lamp: 160LM Night Light (3-Level Brightness): 30LM / 14LM / 4LM
	Rechargeable Battery Powered	Desk Lamp: 130LM Night Light: 24LM (High Brightness)
Battery Type	Lithium battery 18650	1800mAh
Charging Time	4 hours	When light is switched off
Continuous Lighting Time	Desk Lamp: approx 4 hours Night Light: approx 15 hours (High Brightness)	
RA	≥80	
IP Rating	IP20 for indoor use only	
USB Cable Length	(Type C) 1m	
Size	W 100mm x D 130mm x H 500mm	
Weight	0.3kg	
Anti Slip Pad	0 to 40°C	
Ambient Temperature	-10 to 60°C	
Carton Qty	1/20	

DECOR LIGHTING

Buddy Table & Floor Lamps



- Eye Caring
- Flexible Neck (360°)
- Max 2.36 Inch Opening Clip
- 3-Level Brightness
- USB Rechargeable, Adapter Included
- Scratch-resistant Silicon Pad

LED	12pcs SMD2835	6500K
Switch Form	Touch	
Switch Position	Single point shift position, Three touch dimming	Off/ High/ Middle/ Low Brightness
Power Supply	5V DC 1A	
Power	2.5W (High Brightness)	
Lumens (Adapter Powered)	140LM (High Brightness) / 60LM (Middle Brightness) / 14LM (Low Brightness)	
Lumens (Rechargeable Battery Powered)	100LM (High Brightness) / 40LM (Middle Brightness) / 10LM (Low Brightness)	
Battery Type	Lithium battery 18650	1200mAh
Charging Time	Approx 2.5 hours	When light is switched off
Continuous Lighting Time	3 hours (High Brightness); 7 hours (Middle Brightness); 30 hours (Low Brightness)	
RA	≥80	
IP Rating	IP20 for indoor use only	
USB Cable Length	(Type Micro) 1m	
Size	W 58mm x D 122mm x H 456mm	
Weight	0.19kg	
Ambient Temperature	0 to 40°C	
Carton QTY	1/20	

Lotus Table & Floor Lamps



LOTUS1
(White Cloth/ Blonde Wood)



LOTUS2
(Brown Cloth/ Dark Wood)

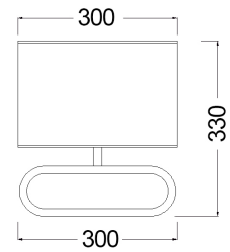

- Interior oval cloth shade table lamps
- Material: wood & cloths
- Globe not included



Part No.	LOTUS1-2
Description	TABLE LAMP ES 40W Oval Cloth + Oval Wood Base
Material	Wood & cloth
Lamp holder	1xE27 (Max.40W)
Dimensions	W300 x H330 x D160mm
Flex & plug	1500mm with on/off inline switch. Not dimmable
Base	W300 x D100mm
Carton QTY	1/4



Tambura Table & Floor Lamps



TAMBURA07TL
(White)



TAMBURA09TL
(White)



TAMBURA10TL
(Black)



TAMBURA08TL
(Black)

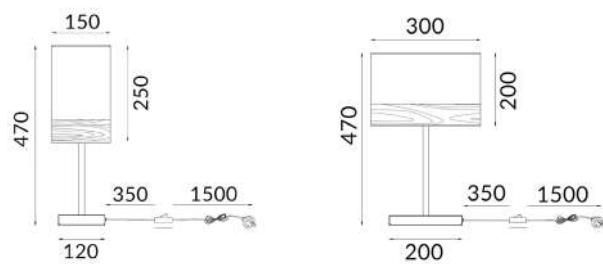

- Interior table & floor lamps
- Material: cloth shade with wood veneer trim
- Base: Power coated iron
- Globe not included



TAMBURA Interior pendant lights are also available

Part No.	TAMBURA07-10TL
Description	TABLE LAMP ES 72W SML Cylinder / Drum Cloth w/Blonde Wood
Material	Cloth shade with wood veneer trim, powder coated iron base
Lamp holder	1xE27 (Max.72W)
Dimensions	TAMBURA07-08TL: Ø150 x H460mm TAMBURA09-10TL: Ø300 x H470mm
Flex & plug	1850mm with on/off inline switch. Not dimmable
Base	TAMBURA07-08TL: Ø120mm TAMBURA09-10TL: Ø100mm
Carton QTY	1/1



TAMBURA11FL
(White)



TAMBURA12FL
(Black)

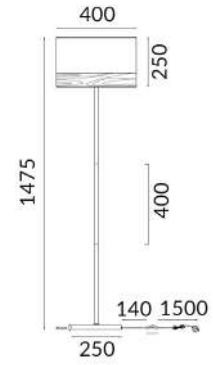

Part No.	TAMBURA11-12FL
Description	FLOOR LAMP ES 72W Large Round Cloth w/Blonde Wood
Material	Cloth shade with wood veneer trim, powder coated iron base
Lamp holder	1xE27 (Max.72W)
Dimensions	Ø400 x H1475mm
Flex & plug	1750mm with on/off inline foot switch. Not dimmable
Base	Ø250mm
Carton QTY	1/1



Pastel Table & Floor Lamps



PASTEL15TL
(Matte White)



PASTEL16TL
(Matte Black)



PASTEL17TL
(Matte Pink)

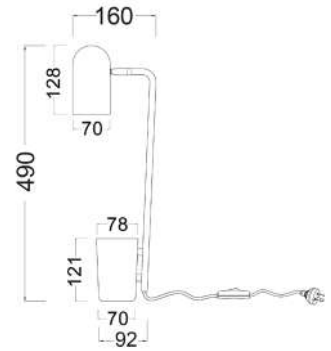

PASTEL18TL
(Matte Grey)



PASTEL19TL
(Matte Green)



PASTEL20TL
(Matte Blue)



PASTEL21TL
(Matte Yellow)

- Interior ellipse adjustable head with ellipse storage base table lamps
- Material: powder coated iron
- Neck fixed, head 360° adjustable
- Globe not included



Part No.	PASTEL15-21TL
Description	TABLE LAMP SES Ellipse with Adjustable Head + Ellipse with Storage Base
Material	Powder coated iron
Lamp holder	1xE14 (Max.40W)
Dimensions	W160 x H490mm
Flex & plug	1800mm with on/off inline switch. Not dimmable
Base	Ø92mm (Can be a pen container)
Carton QTY	1/1



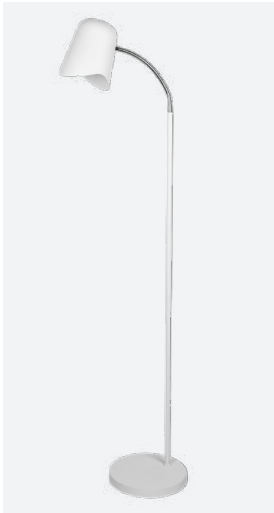

PASTEL22FL
(Matte White)



PASTEL23FL
(Matte Black)

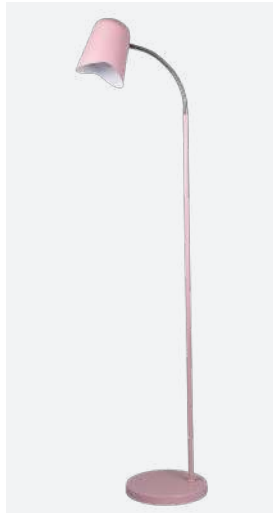

PASTEL24FL
(Matte Pink)

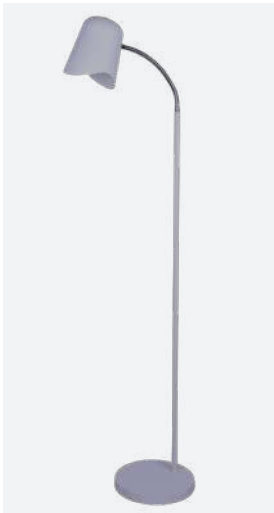
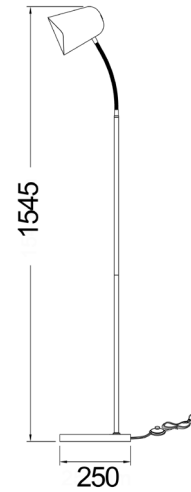

PASTEL25FL
(Matte Grey)

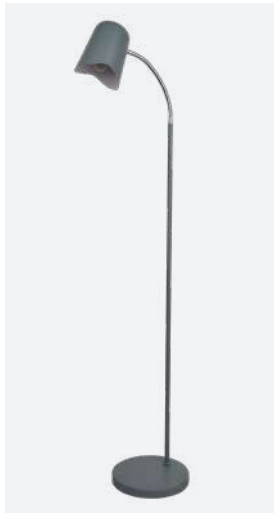

PASTEL26FL
(Matte Green)

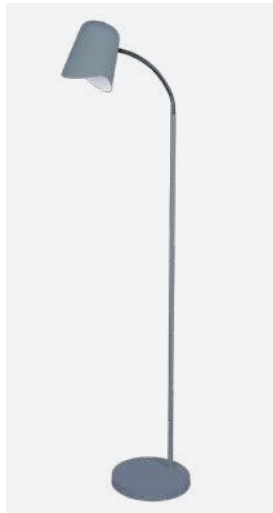

PASTEL27FL
(Matte Blue)

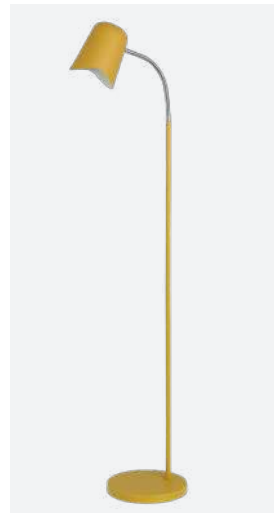

PASTEL28FL
(Matte Yellow)

- Interior ellipse with wavy edge floor lamps
- Material: powder coated iron
- Shde interior colour: white
- Globe not included



Part No.	PASTEL22-28FL
Description	FLOOR LAMP ES Ellipse with Wavy Edge with White Int Flexible + RND Base
Material	Powder coated iron
Lamp holder	1xE27 (Max.40W)
Dimensions	H1545mm
Flex & plug	2080mm with on/off foot inline switch. Not dimmable
Base	Ø250mm
Carton QTY	1/1



PASTEL interior pendant lights are also available



Fokus Table & Floor Lamps



FOKUS01
(White)

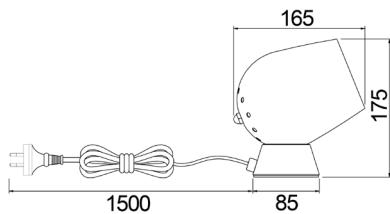

FOKUS02
(Black)



FOKUS03
(Copper)



FOKUS04
(Pewter)

- Interior wine glass touch on/off table lamps
- Material: iron
- Globe not included
- Recommended CLA candle and fancy round LED globes



Part No.	FOKUS01-04
Description	TABLE LAMP SES 25W Wine Glass Touch Lamp + RND Base
Material	Iron
Lamp holder	1xE14 (Max.25W)
Dimensions	W165 x H175mm
Flex & plug	1500mm. Not dimmable
Base	Ø85mm
Carton QTY	1/6

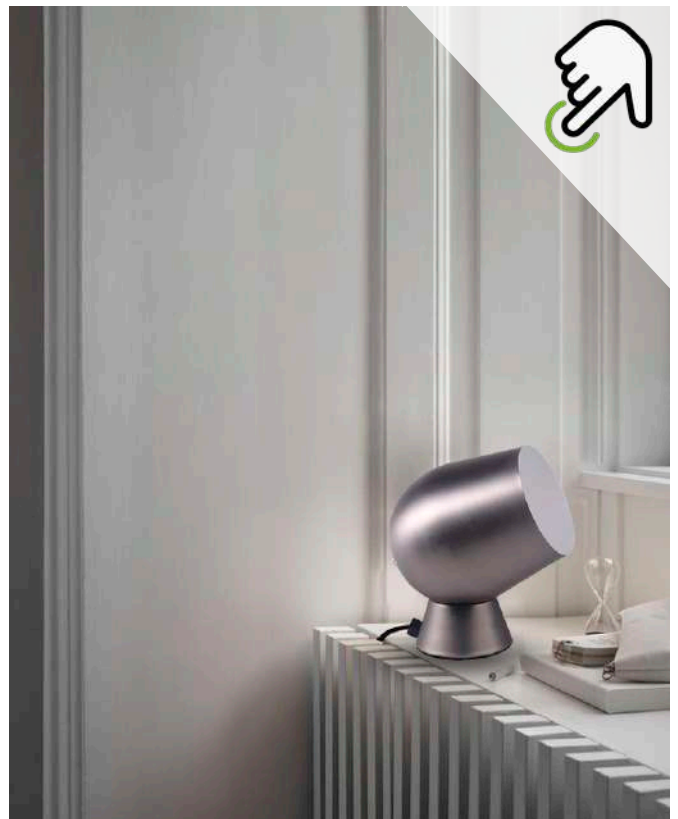

Veneto Table & Floor Lamps



VENETO-T1



VENETO-T2

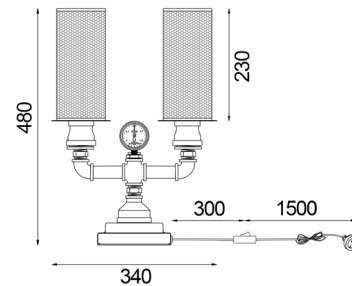
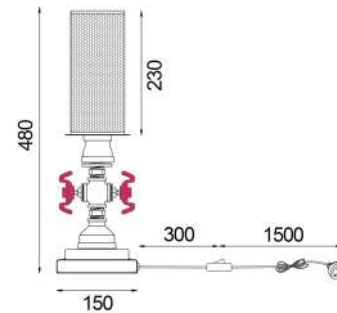

- Interior cylinder with gauge black Mesh table lamps
- Material: iron
- Mesh shade can be removed
- Globe not included



VENETO interior pendant lights and interior wall lights are available

Part No.	VENETO-T1 & VENETO-T2
Description	TABLE LAMP ES 72W Cylinder w/Gauge BLK Mesh + RND BLK Base
Material	Iron
Lamp holder	VENETO-T1: 1xE27 (Max.72W) VENETO-T2: 2xE27 (Max.72W)
Dimensions	H480mm
Flex & plug	1800mm with on/off inline switch. Not dimmable
Base	VENETO-T1: Ø150mm VENETO-T2: Ø100mm
Carton QTY	1/1

Autumn Table & Floor Lamps



AUTUMN04TL

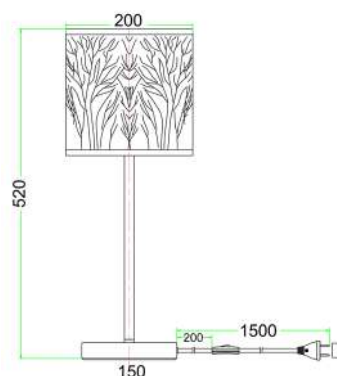

- Interior table lamp
- Shade: iron with aged bronze finish
- Shade lining: PC
- Globe not included



Part No.	AUTUMN04TL
Description	TABLE LAMP ES 60W Drum Perforated (Trees) Aged Bronze + RND Aged Bronze Base
Material	Iron & PC
Lamp holder	1xE27 (Max.60W)
Dimensions	Ø200 x H520mm
Flex & plug	1500mm with on/off inline switch. Not dimmable
Base	Ø150mm
Carton QTY	1/1

DECOR LIGHTING

Interior Wall Lights



Clessidra Interior Wall Lights



CLESSIDRA1W
(Mirror Finished Smokey Black)



CLESSIDRA2W
(Opal)

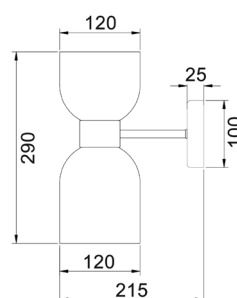

- Interior ellipse wall lights
- Material: iron & glass
- For indoor use only
- Globe not included



Part No.	CLESSIDRA1-2W
Description	Wall Internal S/M ES X 2 72W Ellipse
Material	Iron & glass
Lamp holder	2xE27 (Max.72W)
Dimensions	Ø120 x H290mm
Back plate	Ø100x25mm
Carton QTY	1/1



CLESSIDRA Interior pendant lights are also available



Vinum Interior Wall Lights



VINUM1W
(Chrome Glass)



VINUM2W
(Copper Coloured Glass)

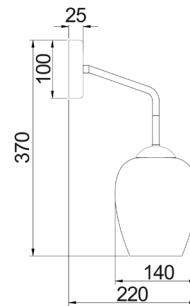

- Interior glass wall lights
- Material: glass
- Globe not included
- For indoor use only



Part No.	VINUM1W-2W
Description	WALL INTERNALS/M ES 72W Glass Blk Iron Bracket With Chrome Highlight
Material	Glass
Lamp holder	1xE27 (Max.72W)
Dimensions	W220 x H370mm
Back plate	Ø100 x 25mm
Carton QTY	1/1



VINUM Interior pendant lights are also available



Pesini Interior Wall Lights



PESINI1W
(Clear Glass)



PESINI4W
(Clear Glass)



PESINI2W
(Smokey Black Glass)



PESINI5W
(Smokey Black Glass)



PESINI3W
(Amber Glass)



PESINI6W
(Amber Glass)



Adjustable swing arm

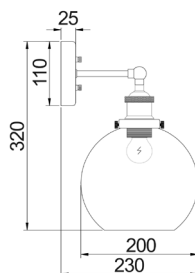

- Interior glass with antique brass / chrome highlight wall lights
- Material: glass & iron
- Adjustable swing arm
- Globe not included
- For indoor use only



Part No.	PESINI1W-6W
Description	WALL INTERNAL S/M ES 72W Wine Glass With Antique Brass / Chrome Bracket
Material	Glass & iron
Lamp holder	1xE27 (Max.72W)
Dimensions	D230 x H320mm
Back plate	Ø110 x 25mm
Carton QTY	1/1



PESINI interior pendant lights are also available

Strung Interior Wall Lights

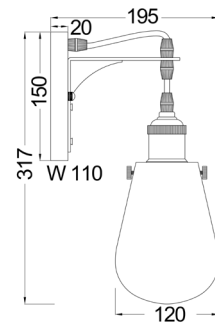

STRUNG1

- Interior surface mounted wall light
- Material: steel & glass
- Colour: black and antique bronze
- Globe not included
- For indoor use only



Part No.	STRUNG1
Description	WALL INTERNAL S/M ES 40W Black / Antique Brass and Clear Pear Shaped Glass
Material	Glass & steel
Lamp holder	1xE27 (Max.40W)
Dimensions	W120 x H317 x D195mm
Back plate	H150 x W110 x D20mm
Carton QTY	1/4



Alta Interior Wall Lights



ALTA1W
(Matte White)

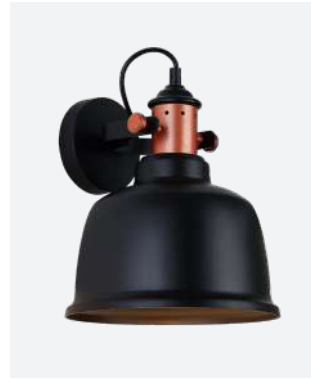

ALTA2W
(Matte Black)



ALTA3W
(Matte Grey)

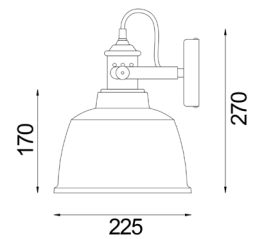

- Interior surface mounted wall lights
- Head adjustable
- Material: iron
- Globe not included
- For indoor use only



Part No.	ALTA1W-3W
Description	WALL INTERNAL ES 72W Adj Bell (with Copper Highlights)
Material	Iron
Lamp holder	1xE27 (Max.72W)
Dimensions	Ø225 x H270mm
Back plate	Ø110mm
Carton QTY	1/10



ALTA interior pendant lights are also available



Steam Interior Wall Lights

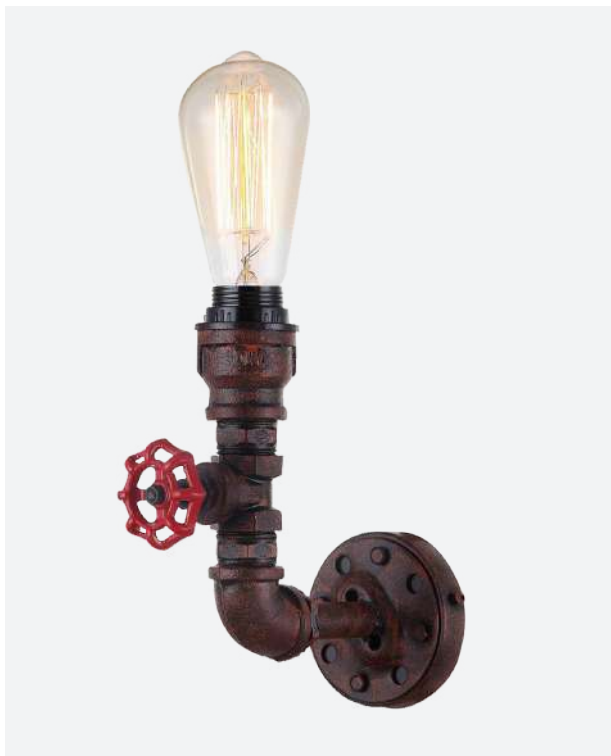

STEAM2
(1XE27)

- Interior surface mounted wall lights
- Material: iron (aged finish)
- Globe not included
- For indoor use only



STEAM3
(4XE27)

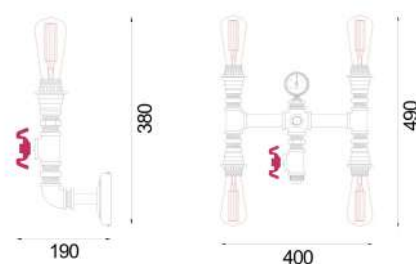

Part No.	STEAM2 & STEAM3
Description	WALL INTERNAL S/M 72W Aged Iron Pipe
Material	Iron
Lamp holder	STEAM2: 1xE27 (Max.72W) STEAM3: 4xE27 (Max.72W)
Dimensions	STEAM2: D190 x H380mm STEAM3: W400 x H490mm
Back plate	Ø95mm
Carton QTY	1/1



AUTUMN03W

- Interior surface mounted wall light
- Shade: iron with aged bronze finish
- Shade lining: PC
- Globe not included
- For indoor use only

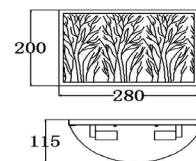

Part No.	AUTUMN03W
Description	WALL Interior S/M SESx2 60W Curved Aged Bronze with Amber Lining
Material	Iron with aged bronze finish & PC
Lamp holder	2xE14 (Max.60W)
Dimensions	W200 x H280 x D115mm
Back plate	280X160mm
Carton QTY	1/1

Veneto Interior Wall Lights

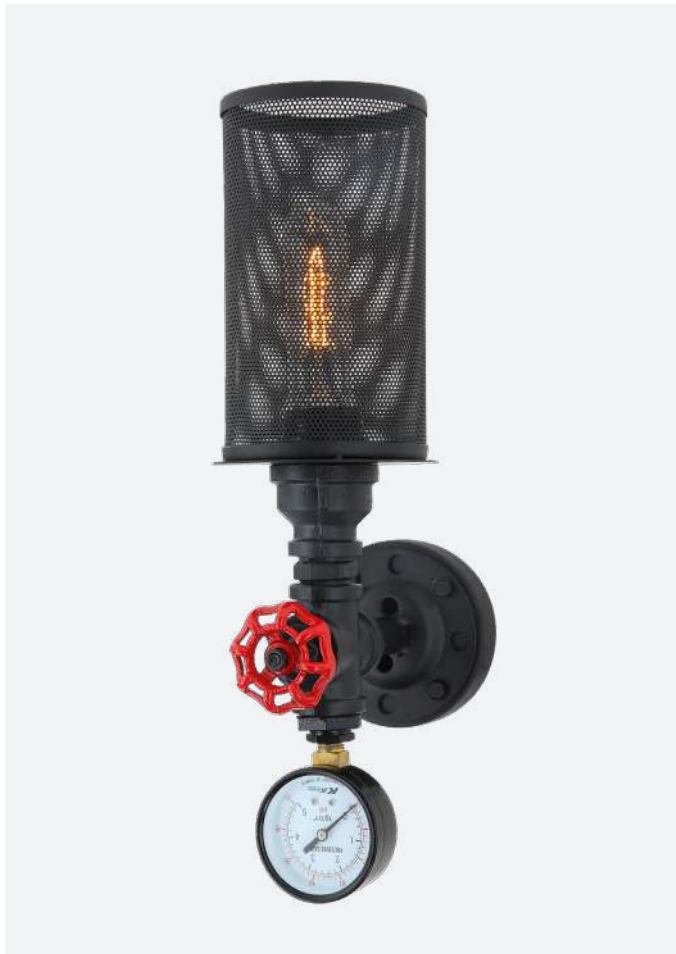

VENETO-W1
(1XE27)



VENETO-W2
(2XE27)

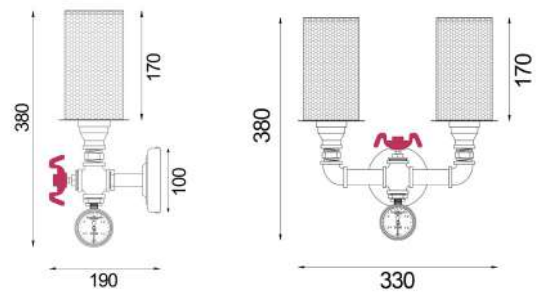

- Interior surface mounted wall lights
- Material: iron
- Matte black finish
- Mesh shade can be removed
- Globe not included
- For indoor use only



Part No.	VENETO-W1 & VENETO-W2
Description	WALL INTERNAL S/M ES 72W BLK Iron
Material	Iron
Lamp holder	VENETO-W1: 1xE27 (Max.72W) VENETO-W2: 2xE27 (Max.72W)
Dimensions	VENETO-W1: D190 x H380mm VENETO-W2: W330 x H380mm
Back plate	Ø100mm
Carton QTY	1/1



VENETO interior pendant lights and table lamps are also available

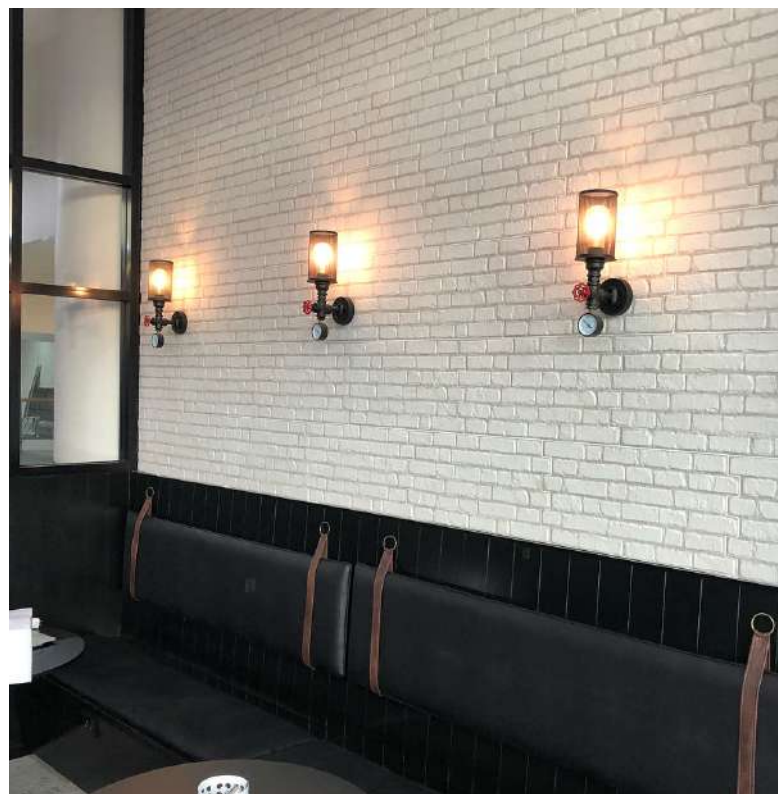

Deksel Interior Wall Lights



DEKSEL02
(Aged Copper)



DEKSEL05
(Matte Black)

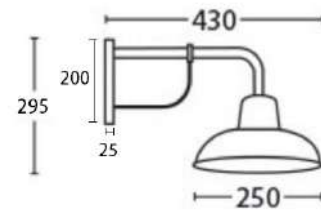

- Interior aged copper / matte black wall lights
- Input voltage range: 110-265V AC
- Shade: aged oxidised solid copper or Aluminium
- Screw: stainless steel
- Globe not included
- For indoor use only



Part No.	DEKSEL02 & DEKSEL05
Description	WALL INTERNAL S/M ES 60W Matte Aged Cop (Brass / Matte Black Aluminium Bracket & Base Neck)
Material	DEKSEL02: Copper DEKSEL05: Aluminium
Lamp holder	1xE27 (Max.60W)
Dimensions	430 x H295mm
Back plate	200 x 25mm
Carton QTY	1/1

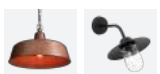

DEKSEL interior pendant lights & exterior wall lights are also available

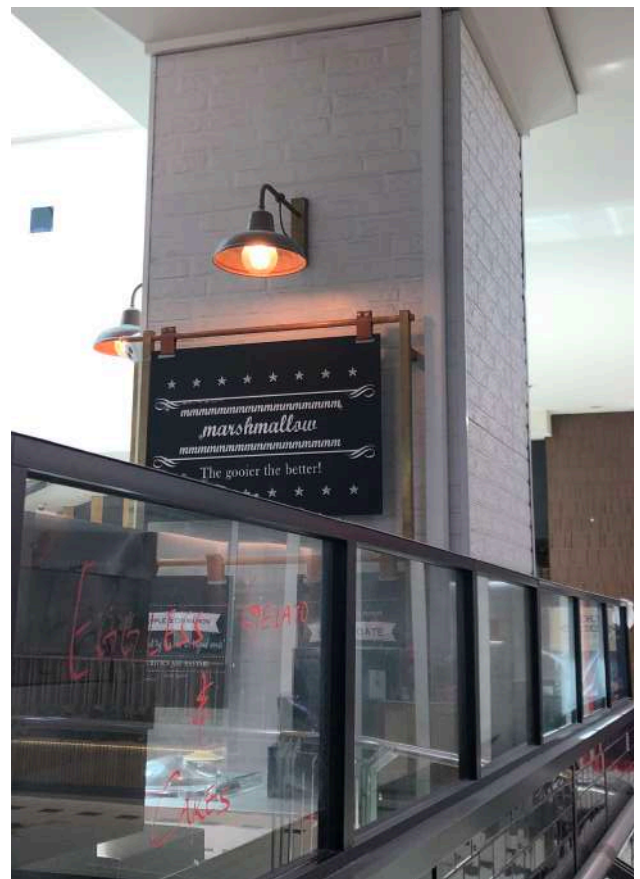

Meti & Sputnik Interior Wall Lights



METI03W

- Interior wall light
- Input voltage: 220-240V AC 50/60Hz
- Material: iron, wood & glass
- Globe not included
- For indoor use only



Part No.	METI03W
Description	WALL INTERNAL ES Warm Chestnut Wood Frame Clear Glass Shades and Oil Rubbed Bronze Hardware
Material	Iron, wood & glass
Lamp holder	1xE27 (Max.60W)
Dimensions	W252 x H340 x D184mm
Back plate	Please see line drawing
Carton QTY	1/1



METI interior pendant lights are also available

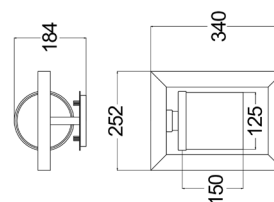

SPUTNIK2

- Interior surface mounted wall light
- Shade: polished nickel/ dark-light grey washed wood
- Globe not included
- For indoor use only



Part No.	SPUTNIK2
Description	WALL INTERNAL ES X 4 Polished Nickel/ Dark-Light Grey Washed
Material	Wood
Lamp holder	4xE27 (Max.60W)
Dimensions	W474 x H685 x D110mm
Back plate	340x140mm
Carton QTY	1/1

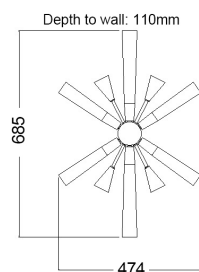

SPUTNIK interior pendant light is also available

City Series Interior Wall Lights



- Interior LED surface mounted wall lights
- Ideal to create ambient lighting
- Low energy long life LED chips
- 12V inbuilt constant current driver included
- Ambient temperature: -20 to 50°C
- For residential and indoor use only
- Suitable for 2 way switching
- Suitable for use with PIR or Microwave sensor



ATLANTA

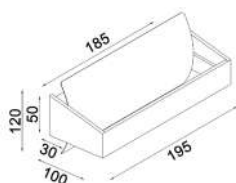

Part No.	ATLANTA
Description	Wall Internal S/M City LED Dimmable WH Rect Up/Dn
Material	Metal & acrylic
Kelvin	3000K/ 4000K/ 5700K
Lumens	691LM/ 754LM/ 707LM
Wattage	6W
LED chips	24pcs SMD2835
Dimensions	D 100 x W 195 x H 120mm
Back plate	L 185 x H 50 x 30mm
Carton QTY	1/10



BRISTOL

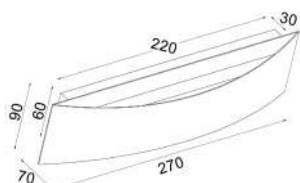

Part No.	BRISTOL
Description	Wall Internal S/M City LED Dimmable WH Curved Up/Dn
Material	Aluminium
Kelvin	3000K/ 4000K/ 5700K
Lumens	565LM/ 614LM/ 605LM
Wattage	8W
LED chips	16pcs SMD2835
Dimensions	D 70 x W 270 x H 90mm
Back plate	L 220 x H 60 x 30mm
Carton QTY	1/10



BAGOTA

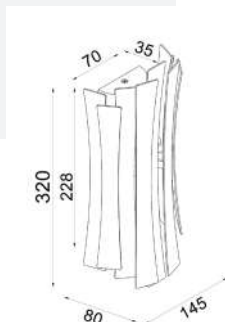

Part No.	BAGOTA
Description	Wall Internal S/M City LED Dimmable WH Curved
Material	Metal
Kelvin	3000K/ 4000K/ 5700K
Lumens	812LM/ 930LM/ 860LM
Wattage	20W
LED chips	48pcs SMD2835
Dimensions	D 80 x W 145 x H 320mm
Back plate	L 70 x H 228 x 35mm
Carton QTY	1/10

Tri-CCT



CARDIFF

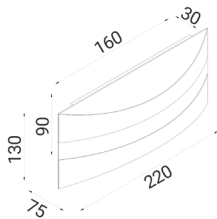

Part No.	CARDIFF
Description	Wall Internal S/M City LED Dimmable WH Rect Up/Dn 5W 120D Tri CCT
Material	Aluminium
Kelvin	3000K/ 4000K/ 5700K
Lumens	429LM/ 442LM/ 403LM
Wattage	5W
LED chips	12pcs SMD2835
Dimensions	D 75 x W 220 x H 130mm
Back plate	L 160 x H 90 x 30mm
Carton QTY	1/10

Tri-CCT



DHAKA

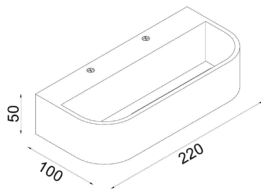

Part No.	DHAKA
Description	Wall Internal S/M City LED Dimmable WH Rect Up/Dn
Material	Aluminium
Kelvin	3000K/ 4000K/ 5700K
Lumens	650LM/ 747LM/ 645LM
Wattage	12W
LED chips	12pcs SMD2835
Dimensions	D 100 x W 220 x H 50mm
Back plate	L 220 x H 50mm
Carton QTY	1/10

Tri-CCT



HELSINKI

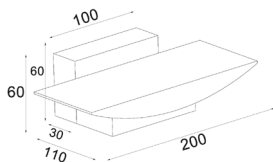

Part No.	HELSINKI
Description	Wall Internal S/M City LED Dimmable WH Curved Up/Dn
Material	Aluminium
Kelvin	3000K/ 4000K/ 5700K
Lumens	567LM/ 619LM/ 586LM
Wattage	6W
LED chips	12pcs SMD2835
Dimensions	D 110 x W 200 x H 60mm
Back plate	L 100 x H 60 x D 30mm
Carton QTY	1/10



Part No.	LIMA1
Description	Wall Internal S/M City LED Dimmable WH Round Rotatable
Material	Aluminium & Acrylic
Kelvin	3000K/ 4000K/ 5700K
Lumens	282LM/ 294LM/ 273LM
Wattage	5W
LED chips	SMD2835
Dimensions	D 50 x OD160 mm
Back plate	OD 110 x D 30mm
Carton QTY	1/10

LIMA1

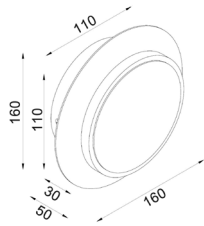

Part No.	LIMA2
Description	Wall Internal S/M City LED Dimmable WH Square Rotatable
Material	Aluminium & Acrylic
Kelvin	3000K/ 4000K/ 5700K
Lumens	317LM/ 328LM/ 304LM
Wattage	6W
LED chips	SMD2835
Dimensions	D 50 x W 160 x H 160mm
Back plate	W 160 x D 30 mm
Carton QTY	1/10

LIMA2

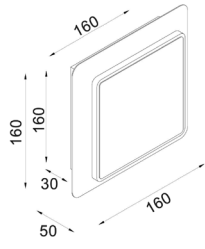

DECOR LIGHTING





Part No.	NAGOYA
Description	Wall Internal S/M City LED Dimmable WH Rect Up/Dn
Material	Aluminium
Kelvin	3000K/ 4000K/ 5700K
Lumens	240LM/ 265LM/ 260LM
Wattage	5W
LED chips	12pcs SMD2835
Dimensions	D 70 x W 190 x H 120mm
Back plate	W 100 x H 60 x D 35 mm
Carton QTY	1/10

NAGOYA

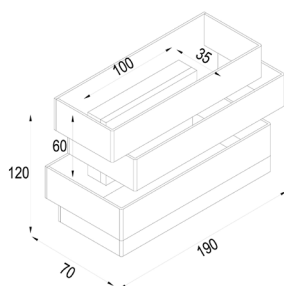



SANTIAGO

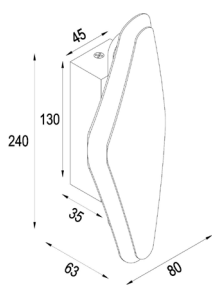

Part No.	SANTIAGO
Description	Wall Internal S/M City LED Dimmable WH Oval
Material	Metal
Kelvin	3000K/ 4000K/ 5700K
Lumens	250LM/ 275LM/ 265LM
Wattage	12W
LED chips	48pcs SMD2835
Dimensions	D 63 x W 80 x H 240 mm
Back plate	W 45 x H 130 x D 35mm
Carton QTY	1/10



SURAT

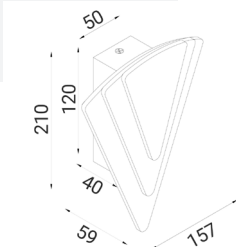

Part No.	SURAT
Description	Wall Internal S/M City LED Dimmable WH Triangular
Material	Aluminium
Kelvin	3000K/ 5000K
Lumens	273LM/ 284LM
Wattage	13W
LED chips	12pcs SMD2835
Dimensions	D 59 x W 157 x H 210mm
Back plate	W 50 x H 120 x D 40 mm
Carton QTY	1/10



TIJUANA

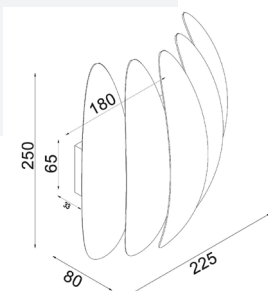

Part No.	TIJUANA
Description	Wall Internal S/M City LED Dimmable WH Curved
Material	Metal
Kelvin	3000K/ 4000K/ 5700K
Lumens	551LM/ 615LM/ 597LM
Wattage	17W
LED chips	40pcs SMD2835
Dimensions	D 80 x W 225 x H 250mm
Back plate	W 180 x H 65 x D 33 mm
Carton QTY	1/10



ATHENSG2

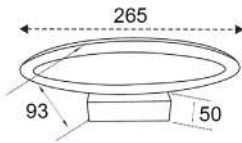

Part No.	ATHENSG2
Description	WALL INTERNAL S/M CITY LED Matte WH Oval 1 Way
Material	Aluminium, iron & acrylic
Kelvin	3000K
Lumens	460LM
Wattage	6W
LED chips	36pcs 2835
Dimensions	D 93 x W 265mm
Back plate	L 100 x W 50 x 30mm
Carton QTY	1/12



BARCELONA



Part No.	BARCELONA
Description	WALL INTERNAL S/M CITY LED Clear Border / Frosted Inner Rect / Brushed S/C Plate
Material	Aluminium, brushed S/C, acrylic & iron
Kelvin	3000K
Lumens	614LM
Wattage	10W
LED chips	160pcs 2835
Dimensions	L 360 x W 135 x D 40mm
Back plate	L 310 x W 45mm
Carton QTY	1/12



CANNES

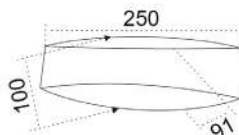

Part No.	CANNES
Description	WALL INTERNAL S/M CITY LED Matte WH Curved Up/DN
Material	Aluminium
Kelvin	3000K
Lumens	468LM
Wattage	6W
LED chips	12pcs 5630
Dimensions	L 250 x W 100 x D 91mm
Back plate	L 120 x W 60 x 35mm
Carton QTY	1/12



DAVOS

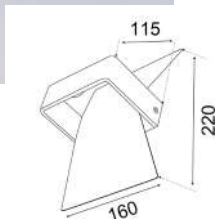

Part No.	DAVOS
Description	ALL INTERNAL S/M CITY LED MATT WH BOW
Material	Iron, Aluminium WH & Acrylic
Kelvin	3000K
Lumens	480LM
Wattage	16W
LED chips	1pc 2835 COB LED
Dimensions	L 220 x W 160 x D 115mm
Back plate	L 120 x W 40 x 45mm
Carton QTY	1/12



DELHI

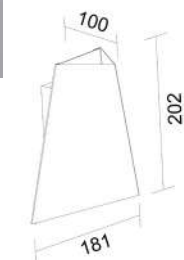

Part No.	DELHI
Description	WALL INTERNAL Angled Up/Down S/M CITY LED Sand WH
Material	Aluminium, acrylic & iron
Kelvin	3000K
Lumens	469LM
Wattage	12W
LED chips	24pcs 2835
Dimensions	L 202 x W 181 x D 100mm
Back plate	L 130 x W 60mm
Carton QTY	1/12



DUBAIG2

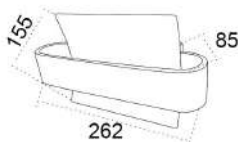

Part No.	DUBAIG2
Description	WALL INTERNAL S/M CITY LED Matte WH Curved
Material	Aluminium, iron & acrylic
Kelvin	3000K
Lumens	460LM
Wattage	6W
LED chips	36pcs 2835
Dimensions	262 x 155 x 85mm
Back plate	L 180 x W 60 x 35mm (Mounting U bracket: 170x30mm, Central 7mm cable hole)
Carton QTY	1/12



LONDON

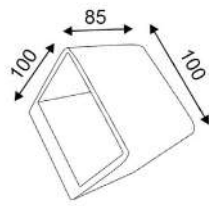

Part No.	LONDON
Description	WALL INTERNAL S/M CITY LED Matte WH Cube UP/DN
Material	Aluminium
Kelvin	3000K
Lumens	450LM
Wattage	6W
LED chips	6pcs 5050
Dimensions	100x100x85mm
Back plate	L 100 x W 85 x 27mm (Mounting U bracket: 60x25mm)
Carton QTY	1/12



NEW YORKG2

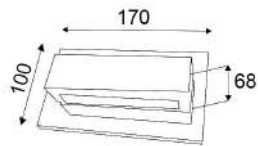

Part No.	NEW YORKG2
Description	WALL INTERNAL S/M CITY LED S/ Nickel with Clear Acrylic Border Rect UP/DN
Material	Aluminium, iron & acrylic
Kelvin	3000K
Lumens	360LM
Wattage	6W
LED chips	36pcs 2835
Dimensions	L 170 x W 100 x D 68mm
Back plate	L140 x W 40 x 30mm (Mounting U bracket: 130x20mm, central 7mm cable hole)
Carton QTY	1/12





PARIS

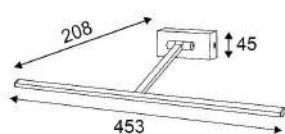

Part No.	PARIS
Description	WALL INTERNAL S/M CITY LED S/C Adj Picture
Material	Iron, copper S/nickel
Kelvin	3000K
Lumens	611LM
Wattage	6W
LED chips	66pcs 2835
Dimensions	W 453 x D 208mm
Back plate	L 100 x W 45 x 25mm (Mounting U bracket: 90x20mm, central 25mm cable hole)
Carton QTY	1/12



PHOENIX

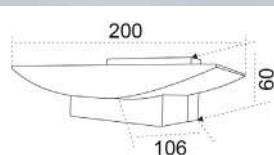

Part No.	PHOENIX
Description	WALL INTERNAL S/M CITY LED Matte WH Curved Uplight
Material	Aluminium, iron & acrylic
Kelvin	3000K
Lumens	395LM
Wattage	6W
LED chips	6pcs 5050
Dimensions	L 200 x W 60 x D 106mm
Back plate	L 90 x W 60mm (Mounting U bracket: 100x20mm, 25mm cable entry off to one side)
Carton QTY	1/12

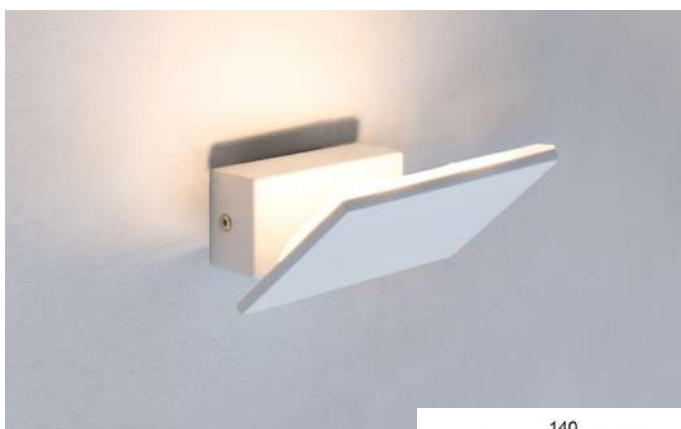

RIOG2

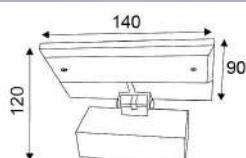

Part No.	RIOG2
Description	WALL INTERNAL S/M CITY LED Matte WH Rect Uplight 90D ADJ
Material	Aluminium, iron, copper WH & acrylic
Kelvin	3000K
Lumens	244LM
Wattage	2x3W
LED chips	2pcs 5050
Dimensions	L 140 x W 90 x D 120mm
Back plate	L100 x W 45 x 30mm (Mounting U bracket: 90x20mm, 25mm cable entry off to one side)
Carton QTY	1/12



ROME G2

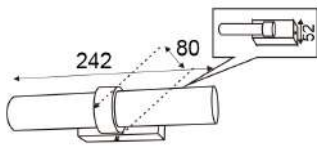

Part No.	ROME G2
Description	WALL INTERNAL S/M CITY LED S/C TUBULAR Up/Dn
Material	Iron, aluminium s/chrome & acrylic diffuser
Kelvin	3000K
Lumens	230LM
Wattage	2x1W
LED chips	2pcs 3535
Dimensions	L 242 x W 80 x D 52mm
Back plate	L 100 x W 45 x 30mm (Central 25mm cable hole)
Carton QTY	1/12



SYDNEY G2

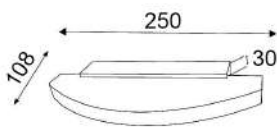

Part No.	SYDNEY G2
Description	WALL INTERNAL S/M CITY LED S/N Curved Frosted DIFF
Material	Aluminium & acrylic
Kelvin	3000K
Lumens	460LM
Wattage	6W
LED chips	36pcs 2835
Dimensions	L 250 x W 30 x D 108mm
Back plate	L 180 x W 30 x 35mm (with 2x20mm cable holes 35mm from each other)
Carton QTY	1/12



VENICE G2

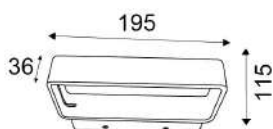

Part No.	VENICE G2
Description	WALL INTERNAL S/M CITY LED Matte WH Rect UP/DN
Material	Aluminium & iron
Kelvin	3000K
Lumens	615LM
Wattage	6W
LED chips	36pcs 2835
Dimensions	L 195 x W 36 x D 115mm
Back plate	L170 x W 36 x 30mm (Central 7mm cable entry)
Carton QTY	1/12



VIENNA

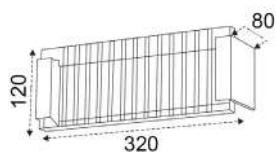

Part No.	VIENNA
Description	WALL INTERNAL S/M CITY LED Matte WH Rect with Clear / Frost Ribbed Diffuser
Material	Iron, aluminium & acrylic
Kelvin	3000K
Lumens	803LM
Wattage	12W
LED chips	12pcs 5050
Dimensions	L 320 x W 120 x D 80mm
Back plate	L 308 x W 90 x 38mm (Mounting plate: 160x30mm, central 7mm cable entry)
Carton QTY	1/12



CHESTER01

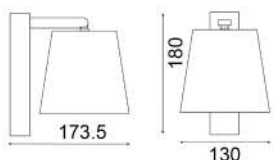

Part No.	CHESTER01
Description	WALL INTERNAL S/M ADJ LED 6W WH 1 switch Clear PS Shade
Material	Aluminium housing, PS shade, iron mounting bracket
Kelvin	3000K
Lumens	402LM
Wattage	6W
LED chips	30pcs 2835
Dimensions	L 180 x W 130 x D 173.5mm
Back plate	180 x 50mm
Carton QTY	1/6



CHESTER02

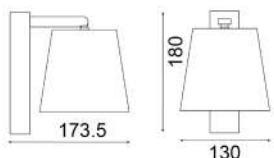

Part No.	CHESTER02
Description	WALL INTERNAL S/M ADJ LED 6W WH 1 switch Clear PS Shade
Material	Aluminium housing, PS shade, iron mounting bracket
Kelvin	5000K
Lumens	480LM
Wattage	6W
LED chips	30pcs 2835
Dimensions	L 180 x W 130 x D 173.5mm
Back plate	180 x 50mm
Carton QTY	1/6



SEATTLE1

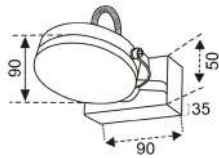

Part No.	SEATTLE1
Description	WALL INTERNAL S/M CITY LED ADJ Bar Chrome
Material	Iron aluminium, chrome & acrylic frosted diffuser
Kelvin	3000K
Lumens	283LM
Wattage	3W
LED chips	3pcs 5050
Dimensions	L 90 x Ø90mm
Back plate	L90 x W 50 x D 35mm
Carton QTY	1/12



SEATTLE2

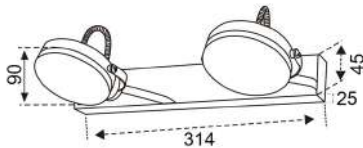

Part No.	SEATTLE2
Description	WALL INTERNAL S/M CITY LED ADJ 2LT Bar Chrome
Material	Iron aluminium, chrome & acrylic frosted diffuser
Kelvin	3000K
Lumens	563LM
Wattage	2x3W
LED chips	6pcs 5050
Dimensions	L 314 x Ø90mm
Back plate	L 314 x W 45 x D 25mm
Carton QTY	1/12



SEATTLE3

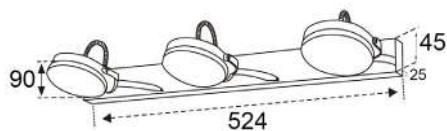

Part No.	SEATTLE3
Description	WALL INTERNAL S/M CITY LED ADJ 3LT Bar Chrome
Material	Iron aluminium, chrome & acrylic frosted diffuser
Kelvin	3000K
Lumens	840LM
Wattage	3x3W
LED chips	9pcs 5050
Dimensions	L 524 x Ø90mm
Back plate	L 524 x W 45 x D 25mm
Carton QTY	1/12



LYON

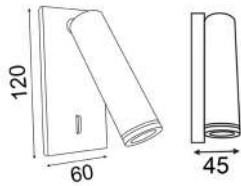

Part No.	LYON
Description	WALL LED S/M Adj Reading Light WH 3W
Material	Aluminium alloy, iron back plate
Kelvin	3000K
Lumens	342LM
Wattage	3W
LED chips	1pc 3535
Dimensions	120x60mm
Cut out	110x30mm
Back plate	120x60mm
Carton QTY	1/12

NOTE: Head is rotatable. Inclusion: on/off switch on back plate



VIGOL

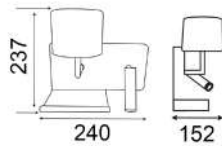

Part No.	VIGOL
Description	WALL INTERNAL S/M CILED Matte WH 2 switch FR Glass Deco & Left Oriented Reading Light (w/USB charger)
Material	Iron, aluminium & acrylic
Kelvin	3000K
Lumens	900LM
Wattage	6W (Main lamp) + 3W (reading light)
LED chips	30pcs 2835 (main lamp) + 1pc 3535 (reading light)
Dimensions	L 240 x W 237 x D 152mm
Back plate	210 x 80mm
Carton QTY	1/6

Independent switches on mounting base, 5V 2A USB charger in side of mounting base, shelf for safe support of device being charged, reading light is rotatable



VIGOR

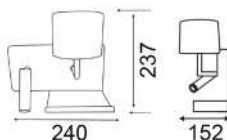

Part No.	VIGOR
Description	WALL INTERNAL S/M LED Matte WH 2 switch FR Glass Decorative & Right Oriented Reading Light (w/USB charger)
Material	Iron, aluminium & acrylic
Kelvin	3000K
Lumens	900LM
Wattage	6W (Main lamp) + 3W (reading light)
LED chips	30pcs 2835 (main lamp) + 1pc 3535 (reading light)
Dimensions	L 240 x W 237 x D 152mm
Back plate	210 x 80mm
Carton QTY	1/6

Independent switches on mounting base, 5V 2A USB charger in side of mounting base, shelf for safe support of device being charged, reading light is rotatable



BRIGHTON01

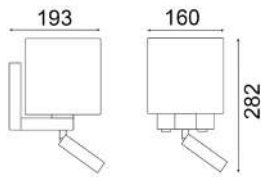

Part No.	BRIGHTON01
Description	WALL INTERNAL S/M ES (60W) Flaxen Shade + LED (3W) Adj Matte WH Reading Light
Material	Cloth shade, aluminium back plate, iron mounting bracket
Lamp holder (main lamp)	1xE27 (Max.60W HAL)
Wattage (reading light)	3W
Kelvin (reading light)	3000K
Lumens (reading light)	278LM
LED chips (reading light)	1pc 3535
Dimensions	L 282 x W 160 x D 193mm
Back plate	L 140 x W 120mm, 2xON/OFF switch on bottom of back plate
Carton QTY	1/6



BRIGHTON02

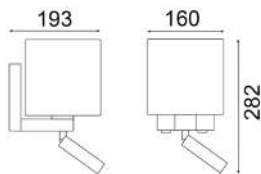

Part No.	BRIGHTON02
Description	WALL INTERNAL S/M ES (60W) Flaxen Shade + LED (3W) Adj Matte WH Reading Light
Material	Cloth shade, aluminium back plate, iron mounting bracket
Lamp holder (main lamp)	1xE27 (Max.60W HAL)
Wattage (reading light)	3W
Kelvin (reading light)	5000K
Lumens (reading light)	298LM
LED chips (reading light)	1pc 3535
Dimensions	L 282 x W 160 x D 193mm
Back plate	L 140 x W 120mm, 2xON/OFF switch on bottom of back plate
Carton QTY	1/6



VANITAS1S, VANITAS1M, VANITAS1L
(White)



VANITAS2S, VANITAS2M, VANITAS2L
(Black)



VANITAS3S, VANITAS3M, VANITAS3L
(Chrome)

- Input voltage: 220-240V 50Hz
- Housing: Aluminium
- Mounting plate: iron
- Diffuser: Acrylic
- Tri-CCT (3000K / 4000K / 5700K) in one fitting
- CCT switch inside the fitting
- LED chips: SMD2835
- CRI: 80
- Power factor: 0.92
- Ambient temp: -20 to 50°C
- Suitable for dimming
- Suitable for 2 way switching
- Suitable for use with sensors

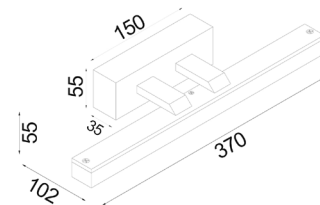

VANITAS1S, 2S, 3S

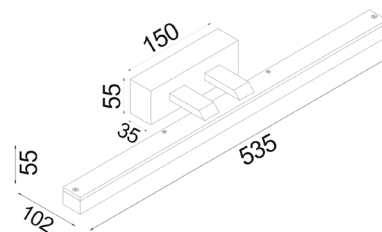

VANITAS1M, 2M, 3M

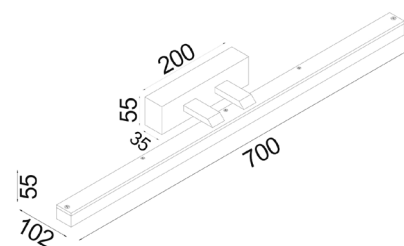

VANITAS1L, 2L, 3L



For Tested and Recommended Dimmers:

- CLA-Trailing Edge: LYNX; VELA
- Clipsal-Universal: 32E450UDM, 31E2PUDM
- Clipsal-Trailing Edge: 32ELEDM-WE; 32E450TM
- HPM-Trailing Edge: CAT250T, CAT400T
- Diginet-LED Smart: MEDM, MMDM/RT

Part No.	Colour	Lumens			Watt	Length	Base	Carton QTY
		3000K	4000K	5700K				
VANITAS1S	Powder coated White	830lm	931lm	803lm	8W	370mm	150x55mm	1/10
VANITAS1M	Powder coated White	1270lm	1339lm	1241lm	12W	535mm	150x55mm	1/10
VANITAS1L	Powder coated White	1680lm	1880lm	1618lm	16W	700mm	200x55mm	1/10
VANITAS2S	Powder coated Black	830lm	931lm	803lm	8W	370mm	150x55mm	1/10
VANITAS2M	Powder coated Black	1270lm	1339lm	1241lm	12W	535mm	150x55mm	1/10
VANITAS2L	Powder coated Black	1680lm	1880lm	1618lm	16W	700mm	200x55mm	1/10
VANITAS3S	Electroplate Chrome	830lm	931lm	803lm	8W	370mm	150x55mm	1/10
VANITAS3M	Electroplate Chrome	1270lm	1339lm	1241lm	12W	535mm	150x55mm	1/10
VANITAS3L	Electroplate Chrome	1680lm	1880lm	1618lm	16W	700mm	200x55mm	1/10





LINEAL1S, LINEAL1M, LINEAL1L
(White)



LINEAL2S, LINEAL2M, LINEAL2L
(Black)

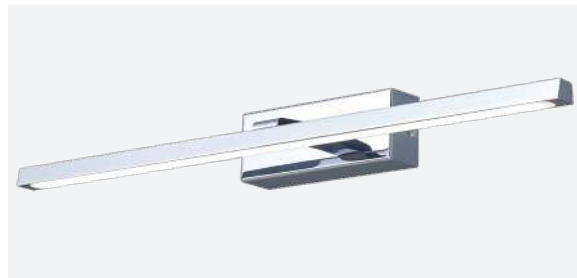

LINEAL3S, LINEAL3M, LINEAL3L
(Chrome)

- Input voltage: 220-240V 50Hz
- Housing: Aluminium
- Mounting plate: iron
- Diffuser: Acrylic
- Tri-CCT (3000K / 4000K / 5700K) in one fitting
- CCT switch inside the fitting
- LED chips: SMD2835
- CRI: 80
- Power factor: 0.92
- Ambient temp: -20 to 50°C
- Suitable for dimming
- Suitable for 2 way switching
- Suitable for use with sensors



For Tested and Recommended Dimmers:

- CLA-Trailing Edge: LYNX; VELA
- Clipsal-Universal: 32E450UDM, 31E2PUDM
- Clipsal-Trailing Edge: 32ELEDM-WE; 32E450TM
- HPM-Trailing Edge: CAT250T, CAT400T
- Diginet-LED Smart: MEDM, MMDM/RT

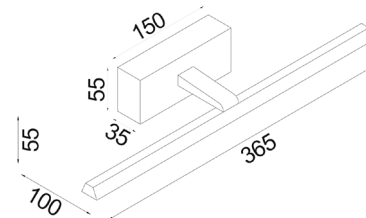

LINEAL1S, 2S, 3S

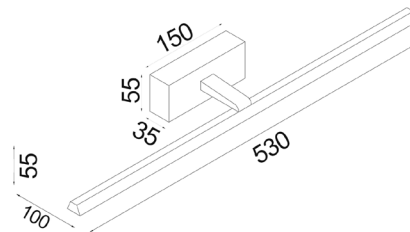

LINEAL1M, 2M, 3M

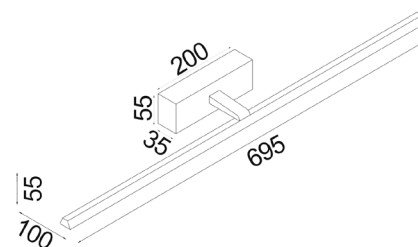

LINEAL1L, 2L, 3L



Part No.	Colour	Lumens			Watt	Length	Base	Carton QTY
		3000K	4000K	5700K				
LINEAL1S	Powder coated White	740LM	762LM	652LM	8W	365mm	150x55mm	1/10
LINEAL1M	Powder coated White	1090LM	1150LM	1000LM	12W	530mm	150x55mm	1/10
LINEAL1L	Powder coated White	1320LM	1531LM	1305LM	16W	695mm	200x55mm	1/10
LINEAL2S	Powder coated Black	740LM	762LM	652LM	8W	365mm	150x55mm	1/10
LINEAL2M	Powder coated Black	1090LM	1150LM	1000LM	12W	530mm	150x55mm	1/10
LINEAL2L	Powder coated Black	1320LM	1531LM	1305LM	16W	695mm	200x55mm	1/10
LINEAL3S	Electroplated Chrome	740LM	762LM	652LM	8W	365mm	150x55mm	1/10
LINEAL3M	Electroplated Chrome	1090LM	1150LM	1000LM	12W	530mm	150x55mm	1/10
LINEAL3L	Electroplated Chrome	1320LM	1531LM	1305LM	16W	695mm	200x55mm	1/10



VANIDAD1L
(Antique Brass)



VANIDAD2L
(Chrome)



On/off Switch

- Input voltage: 180-240V 50/60Hz
- Housing: Electroplate Aluminium
- Heat sink: Aluminium
- Mounting plate: iron
- Diffuser: frosted Acrylic
- Tri-CCT (3000K / 4000K / 5700K) in one fitting
- Inbuilt CCT switch under back plate
- On/off switch on the bottom of the base
- LED chips: 96pcs SMD2835
- CRI: 80
- Power factor: 0.92
- Ambient temp: -20 to 50°C
- Suitable for dimming
- Suitable for 2 way switching
- Suitable for use with sensors

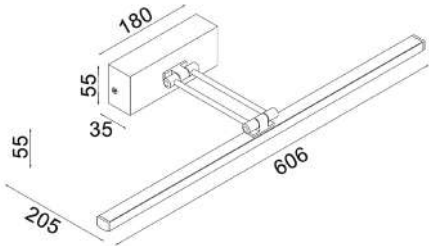

For Tested and Recommended Dimmers:

- CLA-Trailing Edge: LYNX1; VELA
- Clipsal-Universal: 32E450UDM, 31E2PUDM
- Clipsal-Trailing Edge: 32ELEDM-WE; 32E450TM
- HPM-Trailing Edge: CAT250T, CAT400T
- Diginet-LED Smart: MEDM, MMDM/RT

30,000hr
Lifetime

120°
Beam Angle

DIMMABLE

IP44
Rated

2YEAR
Replacement
Warranty

Part No.	Description	Lumens			Watt	Length	Base	Carton Qty
		3000K	4000K	5700K				
VANIDAD1L	WALL Int S/M 20W LINEAR Adj Ant Brass Tri Dim FR Diff	1212lm	1334lm	1311lm	20W	606mm	180x55mm	1/10
VANIDAD2L	WALL Int S/M 20W LINEAR Adj Chrome Tri Dim FR Diff	1212lm	1334lm	1311lm	20W	606mm	180x55mm	1/10

DECOR LIGHTING

Vanity Interior Wall Lights



VANITY-1 (L490mm)
VANITY-2 (L810mm)

- Interior LED surface mounted wall lights
- Input voltage: 240V AC 50/60Hz
- 12V driver included
- Shade: Iron & stainless steel
- Diffuser: acrylic opal
- Chrome finish
- CRI: >80
- Ideal for creating ambient lighting
- Low energy longlife LED lighting
- Not suitable for dimming

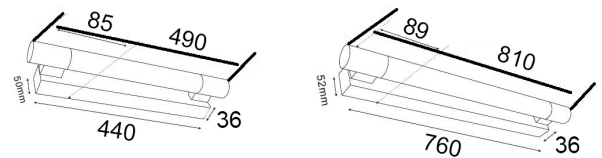

 50,000hr Lifetime	IP44 Rated	2YEAR Replacement Warranty	
---	-------------------	-----------------------------------	---

Part No.	VANITY-1 & VANITY-2
Description	WALL INTERNAL S/M VANITY LED CHROME Frosted Acrylic Diffuser
Material	Iron, stainless steel, acrylic opal
Kelvin	4000K
Lumens	VANITY-1: 525LM VANITY-2: 986LM
Wattage	VANITY-1: 7.68W VANITY-2: 19.2W
CRI	>80
LED chips	-
Dimensions	VANITY-1: L490 x W50 x D85mm VANITY-2: L810 x W52 x D89mm
Back plate	VANITY-1: L440 x W36 x D50mm VANITY-2: L760 x W36 x D52mm
Carton QTY	VANITY-1: 1/12 VANITY-2: 1/6





DECOR LIGHTING

D.I.Y. Decor Lighting

Diypen D.I.Y. Decor Lighting



DIYPEN1
(Black)



DIYPEN2
(White)



BC Plug adaptor to suit
standard Batten holder



Application with CLA
SHADE Series

- D.I.Y. pendant suspension kits
- Input voltage: 220-240V
- Material: iron
- Lamp holder: 1x E27 (Max. 40W globe)
- Maximum weight of shade: 1kg
- Globe/Batten holder not included
- Cable can be adjusted
- For indoor use only

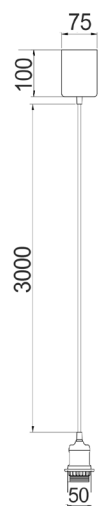

Part No.	Colour	Diameter	Cable	Canopy	Carton Qty
DIYPEN1	Black	Ø50mm	3000mm	Ø75x100mm	1/10
DIYPEN2	White	Ø50mm	3000mm	Ø75x100mm	1/10



DIYBAT01
(Black / Clear Glass)



DIYBAT02
(Chrome / Clear Glass)

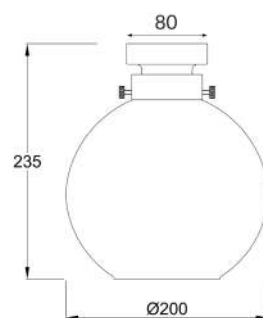

DIYBAT03
(Black / Smokey Black Glass)



DIYBAT04
(Chrome / Smokey Black Glass)

- D.I.Y. wine glass batten fittings
- Input voltage range: 220-240V AC
- Surface mounted
- Material: iron & glass
- Globe type: B22 (Max.40W)
- Globe not included
- Batten holder not included

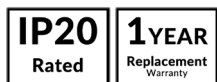

Part No.	DIYBAT01-04
Description	DIY Batten Fitting Wine Glass Clear / Smokey Black
Material	Iron & glass
Lamp Holder	-
Dimensions	Ø200 x H 235mm
Back plate	Ø80mm
Carton QTY	1/8





DIYBAT05
(Black / Clear Glass)



DIYBAT06
(Chrome / Clear Glass)

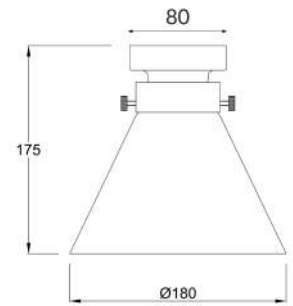

DIYBAT07
(Black / Smokey Black Glass)



DIYBAT08
(Chrome / Smokey Black Glass)

- D.I.Y. cone (flat top) batten fittings
- Input voltage range: 220-240V AC
- Surface mounted
- Material: iron & glass
- Globe type: B22 (Max.40W)
- Globe not included
- Batten holder not included

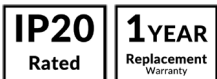

Part No.	DIYBAT05-08
Description	DIY Batten Fitting SML Cone Clr/ Smokey
Material	Iron & glass
Lamp Holder	-
Dimensions	Ø180 x H 175mm
Back plate	Ø80mm
Carton QTY	1/12





DIYBAT09
(Black / Clear Glass)



DIYBAT10
(Chrome / Clear Glass)

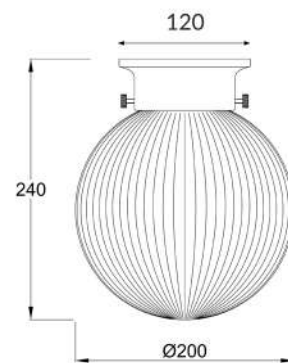

DIYBAT11
(Black / Smokey Black Glass)



DIYBAT12
(Chrome / Smokey Black Glass)

- D.I.Y. sphere ribbed batten fittings
- Input voltage range: 220-240V AC
- Surface mounted
- Material: iron & glass
- Globe type: B22 (Max.40W)
- Globe not included
- Batten holder not included

IP20
Rated

1 YEAR
Replacement
Warranty

Part No.	DIYBAT09-12
Description	DIY Batten Fitting LGE Spherical Ribbed Clr/ Smokey
Material	Iron & glass
Lamp Holder	-
Dimensions	Ø200 x H 240mm
Back plate	Ø120mm
Carton QTY	1/8





DIYBAT13
(Black / Clear Glass)

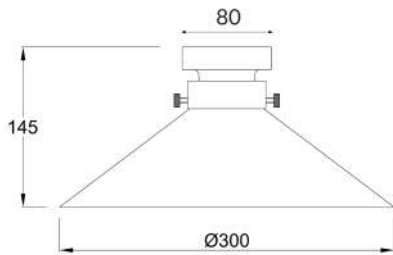

DIYBAT14
(Chrome / Clear Glass)



DIYBAT15
(Black / Smokey Black Glass)



DIYBAT16
(Chrome / Smokey Black Glass)

- D.I.Y. coolie batten fittings
- Input voltage range: 220-240V AC
- Surface mounted
- Material: iron & glass
- Globe type: B22 (Max.40W)
- Globe not included
- Batten holder not included

IP20
Rated

1YEAR
Replacement
Warranty

Part No.	DIYBAT13-16
Description	DIY Batten Fitting LGE Coolie Clr/ Smokey
Material	Iron & glass
Lamp Holder	-
Dimensions	Ø300 x H 145mm
Back plate	Ø80mm
Carton QTY	1/4





DIYBAT17
(Black / Clear Glass)



DIYBAT18
(Chrome / Clear Glass)

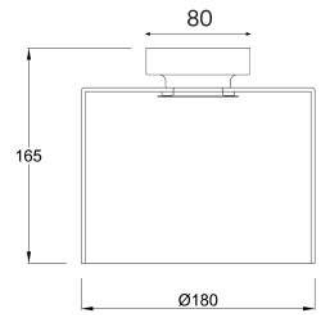

DIYBAT19
(Black / Smokey Black Glass)



DIYBAT20
(Chrome / Smokey Black Glass)

- D.I.Y. cylinder batten fittings
- Input voltage range: 220-240V AC
- Surface mounted
- Material: iron & glass
- Globe type: B22 (Max.40W)
- Globe not included
- Batten holder not included

IP20
Rated

1 YEAR
Replacement
Warranty

Part No.	DIYBAT17-20
Description	DIY Batten Fitting Oblong Clr/ Smokey OD180mm
Material	Iron & glass
Lamp Holder	-
Dimensions	Ø180 x H 165mm
Back plate	Ø80mm
Carton QTY	1/12





DIYBATC01
(Copper)



DIYBATC02
(Polished Brass)



DIYBATC03
(Antique Brass)



DIYBATC04
(Chrome)



DIYBATC05
(Black)



DIYBATC06
(White)

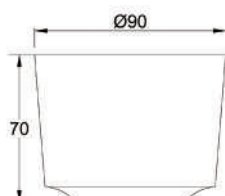

- D.I.Y. cone (flat top) batten fitting covers
- Input voltage range: 220-240V AC
- Surface mounted
- Material: iron
- Globe type: B22 (Max.40W)
- Globe not included
- Batten holder not included

IP20
Rated

1YEAR
Replacement
Warranty

Part No.	DIYBATC01-06
Description	DIY Batten Fitting Cover
Material	Iron
Lamp Holder	-
Dimensions	Ø90 x H 70mm
Back plate	Ø90mm
Carton QTY	1/24

Shade D.I.Y. Decor Lighting



SHADE01
(White)



SHADE02
(Black)



SHADE03
(Grey)



SHADE04
(Natural)

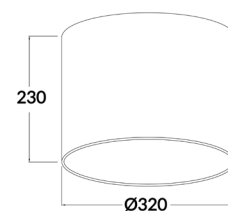

Adjustable Wireframe

- D.I.Y. drum lampshades
- Adjustable wireframe: iron (white)
- Shade: linen
- Lining: PVC (white)
- Versatile: suits table lamps, floor lamps, pendant lights or mount it on ceiling with a batten holder
- Includes adaptor rings to suit bigger lamp holders

1 YEAR
Replacement
Warranty

Part No.	SHADE01-04
Description	DIY Drum Lampshade
Material	Iron, linen & PVC
Lamp Holder	-
Dimensions	Ø320 x H 230mm
Carton QTY	1/1





SHADE05
(White)



SHADE06
(Black)



SHADE07
(Grey)



SHADE08
(Natural)

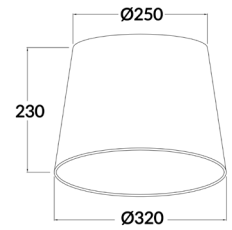

- D.I.Y. slant lampshades
- Adjustable wireframe: iron (white)
- Shade: linen
- Lining: PVC (white)
- Versatile: suits table lamps, floor lamps, pendant lights or mount it on ceiling with a batten holder
- Includes adaptor rings to suit bigger lamp holders



Part No.	SHADE05-08
Description	DIY Slant Lampshade
Material	Iron, linen & PVC
Lamp Holder	-
Dimensions	Ø250 / Ø320 x H 230mm
Carton QTY	1/1





Exterior Lighting

For environments with harsh weather conditions or heavy rainfall, IP65 fittings are recommended for such environments. To avoid disappointment and warranty problems, please ensure the IP Rating of the chosen product is relevant for the intended use.

Rubik Exterior Lighting

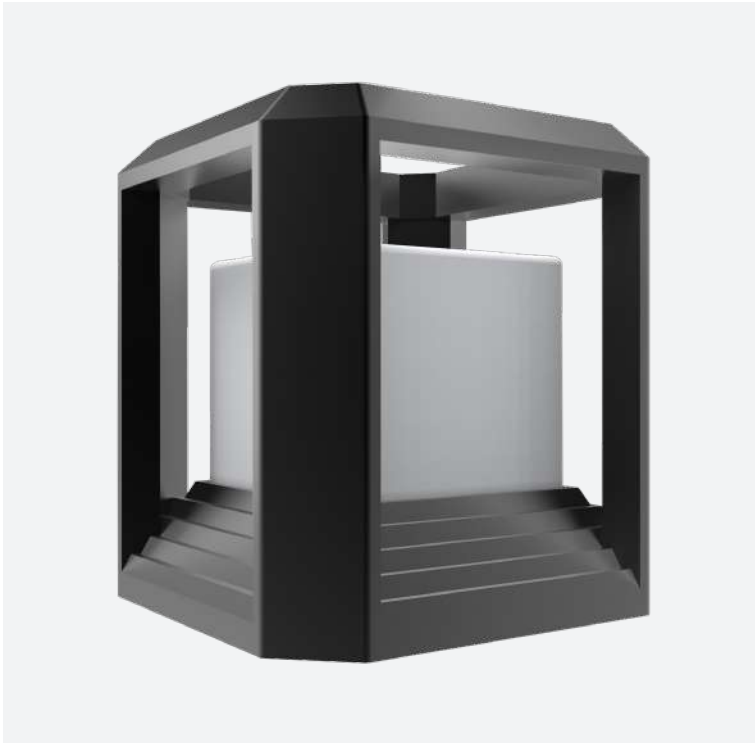

RUBIK1
(Matte Black)



RUBIK2
(Matte White)

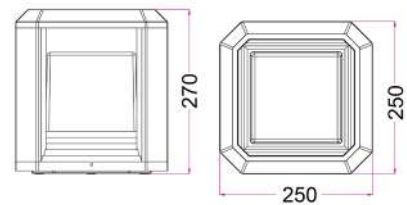

- Exterior LED cube wall / floor lamps
- Input voltage range: 100-240V AC 50/60Hz
- Constant current driver included
- Shade: double anti-corrosion powder coated high-pressure casted aluminium
- Shade internal colour: white
- Diffuser: anti aging UV protected PC
- LED chips: 20pcs 3030
- Power factor: >0.5
- Ambient temperature: -20 to 50°C
- Not suitable for dimming
- Suitable for 2 way switching
- Suitable for use with PIR or Microwave sensors



Part No.	RUBIK1-2
Description	WALL / FLOOR LED 240V S/M Cube 4 Way Post Top with WH + FLUSH Base
Material	Aluminium & PC
Kelvin	3000K
Lumens	RUBIK1: 1071LM; RUBIK2: 850LM
Wattage	20W
CRI	>80
Dimensions	W 250 x H 270mm
Back plate	Ø110x D20mm
Carton QTY	1/2



*To avoid disappointment and warranty problems, please ensure the IP Rating of the chosen product is relevant for the intended use.

Spy Exterior Lighting



SPY-C1
(Matte White / Pendant Light)



SPY-C2
(Matte Black / Pendant Light)



SPY-W1
(Matte White / Wall Light)



SPY-W2
(Matte Black / Wall Light)



- Exterior pendant & surface mounted wall lights
- Input voltage range: 220-240V AC 50/60Hz
- Shade: aluminium
- Diffuser: glass
- Lamp holder: E27 (Max.60W Halogen/ 10W LED)
- Globes not included

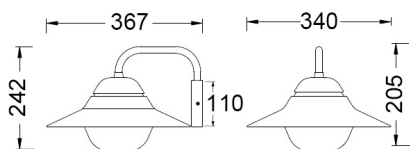

Part No.	SPY-C1, SPY-C2
Description	PENDANT Ec ES 60W Sun Hat w/ FR Diff + RND Canopy
Material	Aluminium & glass
Lamp Holder	1xE27 (Max.60W HAL/ 10W LED)
Dimensions	Ø340 x H 205mm
Suspension	3m cable
Canopy	Ø110mm
Carton QTY	1/4

Part No.	SPY-W1, SPY-W2
Description	WALL ES 60W Sun Hat w/FR Diff + RND Base
Material	Aluminium & glass
Lamp Holder	1xE27 (Max.60W HAL/ 10W LED)
Dimension	367 x H 242mm
Back plate	Ø110x D20mm
Carton QTY	1/1

*Unless protected, not recommended for environments with harsh weather conditions or heavy rainfall. IP65 fittings recommended for such environments. To avoid disappointment and warranty problems, please ensure the IP Rating of the chosen product is relevant for the intended use.

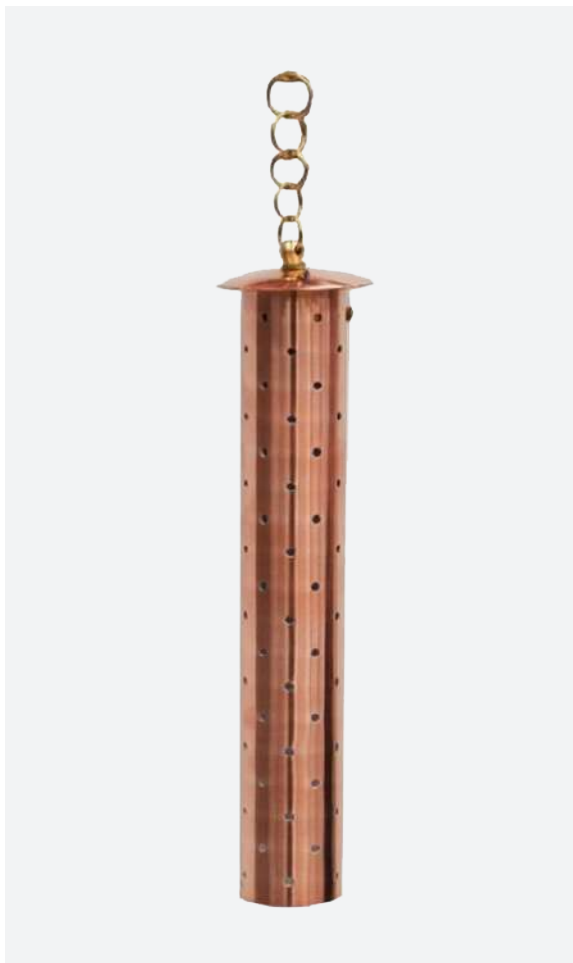

TREEC

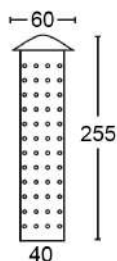

- Exterior tree / single pendant light
- Input voltage: 12V DC/AC
- External Control Gear Required
- Recommended CLA LED driver: OTTER1
- Lamp holder: MR11 (Replaced by removing cylinder from canopy-held by 1 screw) (Max.20W)
- Globe not included
- Recommended CLA LED MR11 Globes

Part No.	TREEC
Description	TREE / PENDANT EXTERIOR MR11 12V Cylinder Perforated (Holes) COP + Br chain
Material	Solid copper
Lamp Holder	1xMR11 (Max.20W)
Dimensions	Ø60 x H 255mm
Suspension	50mm chain & 950mm cable
Carton QTY	1/1

MR11

IP23
 Rated

2YEAR
 Replacement
Warranty

**Unless protected, not recommended for environments with harsh weather conditions or heavy rainfall. IP65 fittings recommended for such environments. To avoid disappointment and warranty problems, please ensure the IP Rating of the chosen product is relevant for the intended use.*

Skopa Exterior Lighting



SKOPA1
(Galvanized Steel)



SKOPA2
(Copper)

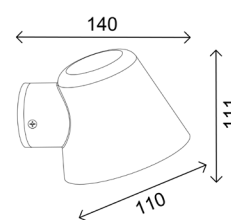

- Exterior surface mounted wall lights
- Input voltage range: 220-240V AC 50/60Hz
- Material: galvanized steel or copper
- Lamp holder: GU10 (Max.35W)
- Globes not included



Part No.	SKOPA1, SKOPA2
Description	WALL GU10 S/M Cone (Flat Top) + RND FLUSH Base
Material	Galvanized steel/ copper
Lamp holder	1xGU10 (Max.35W)
Dimensions	Ø110 x H 111 x D 140mm
Back plate	Ø50x D35mm
Carton QTY	1/12



**Unless protected, not recommended for environments with harsh weather conditions or heavy rainfall. IP65 fittings recommended for such environments. To avoid disappointment and warranty problems, please ensure the IP Rating of the chosen product is relevant for the intended use.*

Deksel Exterior Lighting



DEKSEL01
(Copper)



DEKSEL04
(Matte Black)

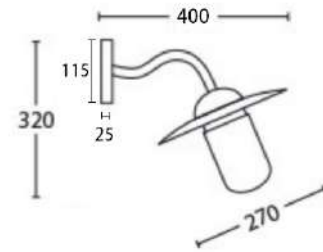

- Exterior surface mounted wall light
- Input voltage range: 110-265V AC
- Shade: aged oxidised solid copper or aluminium
- Screw: stainless steel
- Lamp holder: E27 (Max.60W)
- Globe not included

 E27	IP54 Rated	2YEAR Replacement Warranty
--	----------------------	---

Part No.	DEKSEL01 & DEKSEL04
Description	WALL ES 60W Sun Hat Aged COP w/ Gooseneck OR Matte Black
Material	DEKSEL01: Aged oxidised solid copper DEKSEL04: aluminium
Lamp holder	1xE27 (Max.60W)
Dimensions	400x320mm
Back plate	115x25mm
Carton QTY	1/4

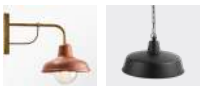

DEKSEL interior wall light and interior pendant light are also available

**Unless protected, not recommended for environments with harsh weather conditions or heavy rainfall. IP65 fittings recommended for such environments. To avoid disappointment and warranty problems, please ensure the IP Rating of the chosen product is relevant for the intended use.*

Hink Exterior Lighting



HINK1
(Matte Black)



HINK2
(Matte White)

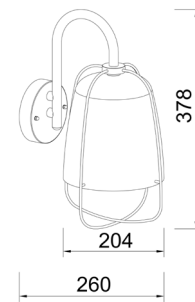

- Exterior surface mounted wall lights
- Input voltage range: 220-240V AC 50/60Hz
- Material: aluminium
- Lamp holder: E27 (Max.60W)
- Globes not included



Part No.	HINK1, HINK2
Description	WALL ES 60W S/M Ellipse with Cage w/Gooseneck + RND Base
Material	Aluminium
Lamp holder	1xE27 (Max.60W)
Dimensions	Ø204 x H 378 x D 260mm
Back plate	Ø105x D20mm
Carton QTY	1/6

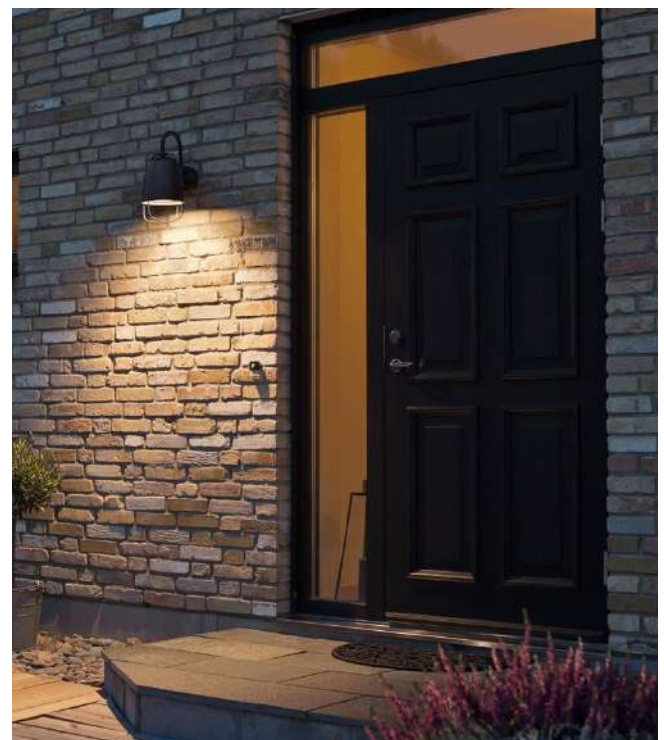

**Unless protected, not recommended for environments with harsh weather conditions or heavy rainfall. IP65 fittings recommended for such environments. To avoid disappointment and warranty problems, please ensure the IP Rating of the chosen product is relevant for the intended use.*

Magnum Exterior Lighting



MAGNUM1
(Matte White)



MAGNUM2
(Matte Black)

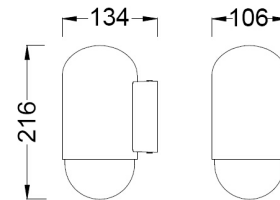

- Exterior surface mounted wall lights
- Input voltage range: 220-240V AC 50/60Hz
- Housing: aluminium
- Diffuser: glass
- Lamp holder: E27 (Max.40W Halogen/ 8W LED)
- Globes not included

 E27	IP44 Rated	2YEAR Replacement Warranty
--	----------------------	---

Part No.	MAGNUM1, MAGNUM2
Description	WALL ES 40W S/M Cylinder + Flush Base
Material	Die cast aluminium
Lamp holder	1xE27 (Max.40W HAL/ 8W LED)
Dimensions	W 106 x H 216 x D 134mm
Back plate	L 100 x W 55 x D 35mm
Carton QTY	1/6

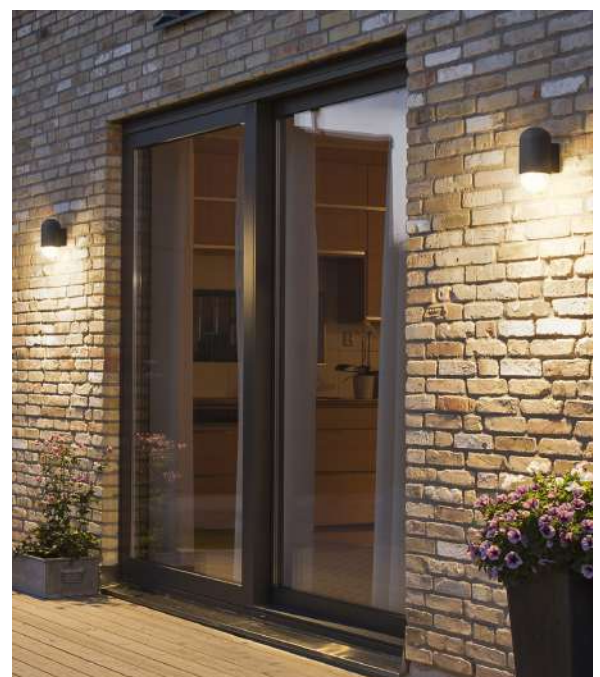

EXTERIOR LIGHTING

**Unless protected, not recommended for environments with harsh weather conditions or heavy rainfall. IP65 fittings recommended for such environments. To avoid disappointment and warranty problems, please ensure the IP Rating of the chosen product is relevant for the intended use.*

Torque Exterior Lighting



TORQUE1
(Matte White)



TORQUE2
(Matte Black)

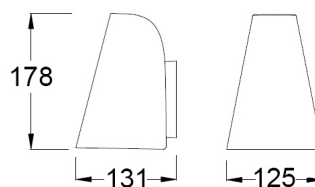

- Exterior surface mounted wall lights
- Input voltage range: 220-240V AC 50/60Hz
- Housing: aluminium
- Diffuser: glass
- Lamp holder: E27 (Max.60W Halogen /8W LED)
- Globes not included



Part No.	TORQUE1, TORQUE2
Description	WALL ES 60W Cone (Flat Top) + Flush Base
Material	Aluminium & glass
Lamp holder	1xE27 (Max.60W HAL/ 8W LED)
Dimensions	W 125 x H 178 x D 131mm
Back plate	L 100 x W 50 x D 15mm
Carton QTY	1/12

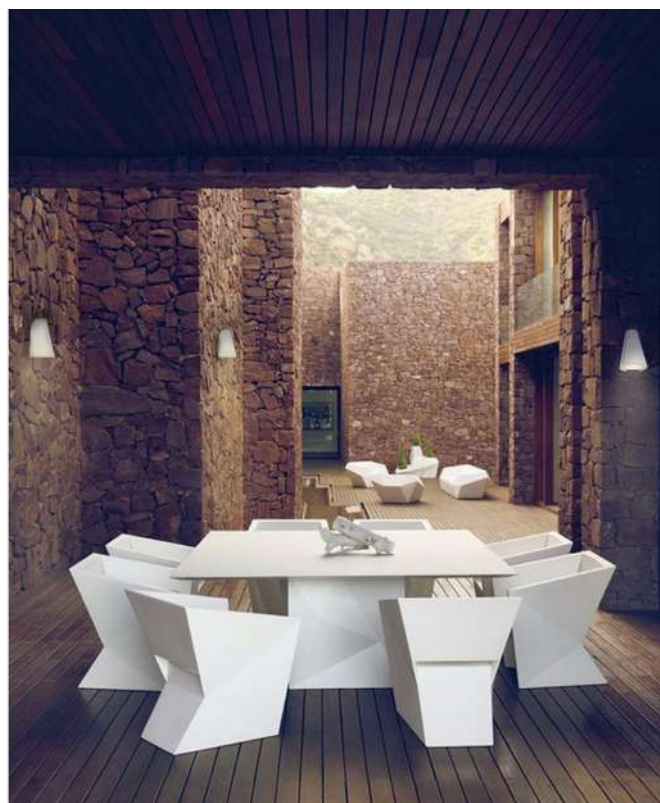

**Unless protected, not recommended for environments with harsh weather conditions or heavy rainfall. IP65 fittings recommended for such environments. To avoid disappointment and warranty problems, please ensure the IP Rating of the chosen product is relevant for the intended use.*

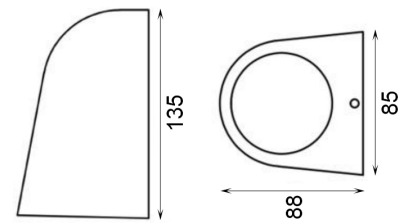

TORQUE3 & TORQUE4

- Exterior surface mounted wall lights
- Single fixed head
- Input voltage range: 110-265V AC or 12-24V AC
- Housing: solid brass
- Diffuser: glass
- Lamp holder: GU10 or MR16
- Globes not included

GU10	MR16	IP65 Rated	2YEAR Replacement Warranty
-------------	-------------	----------------------	---

Part No.	TORQUE3
Description	WALL GU10 35W Ellipse Antique Brass + Flush Base
Material	Solid brass & glass
Lamp holder	1xGU10 (Max.35W)
Dimensions	W 85 x H 135 x D 88mm
Back plate	135x85mm
Carton QTY	1/10

Part No.	TORQUE4
Description	WALL MR16 20W Ellipse Antique Brass + Flush Base
Material	Solid brass & glass
Lamp holder	1xMR16 (Max.20W)
Dimensions	W 85 x H 135 x D 88mm
Back plate	135x85mm
Carton QTY	1/10

**To avoid disappointment and warranty problems, please ensure the IP Rating of the chosen product is relevant for the intended use.*

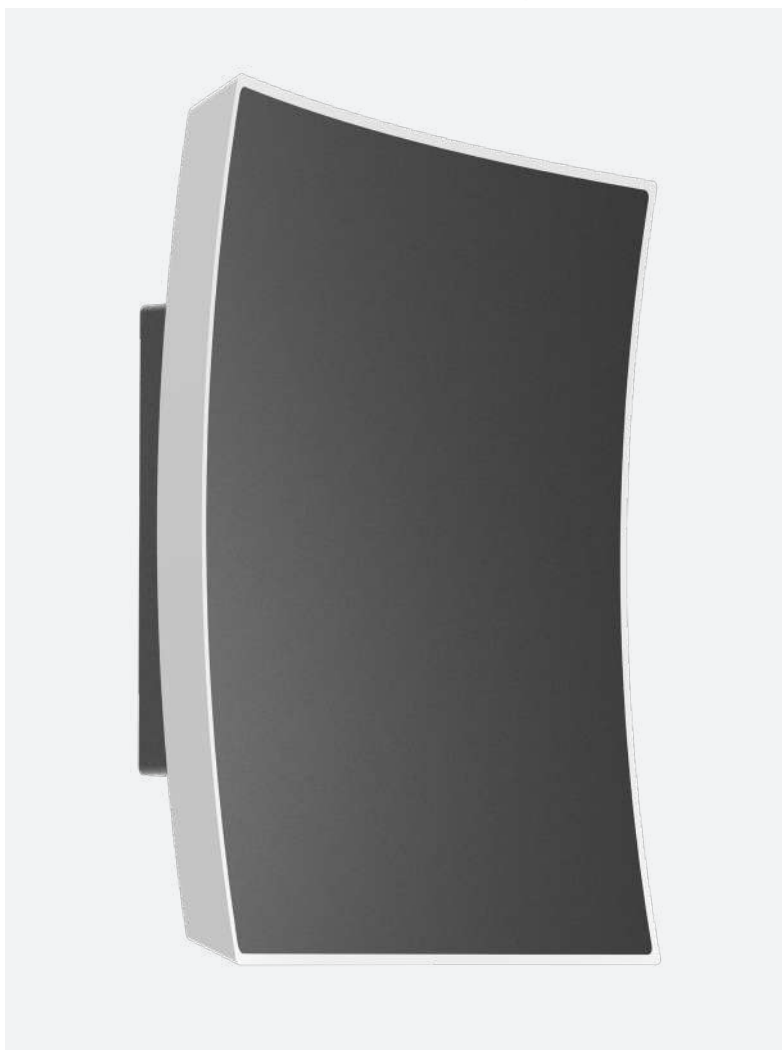

CRISTAL1
(Dark Grey)



CRISTAL2
(White)



- Input voltage: 100-240V 50/60Hz
- Inbuilt Constant Current LED driver
- Surface mounted
- Housing: Powder coated aluminium
- Heat sink: aluminium
- Mounting plate: PC
- Tri-CCT (3000K/ 4000K/ 6500K) in one fitting
- CCT switch inside the fitting
- LED chips: 64pcs SMD2835
- CRI: >80
- Power factor: >0.8
- Ambient temperature: -20 to 50°C
- Not suitable for dimming
- Suitable for 2-way switching
- Suitable for use with PIR or Microwave sensor

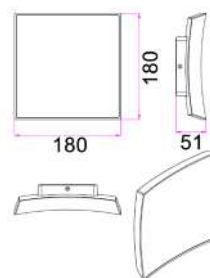

Part No.	CRISTAL1, CRISTAL2
Description	WALL S/M 13W LED TRI 1111Lm IP65 Curved Square
Material	Aluminium & PC
Kelvin	3000K/ 4000K/ 6500K
Lumens	1031LM/ 1111LM/ 1095LM
Wattage	13W
Power Factor	>0.8
CRI	>80
Dimensions	L180 x W180 x D51mm
Back plate	98x98mm
Carton QTY	1/6



*To avoid disappointment and warranty problems, please ensure the IP Rating of the chosen product is relevant for the intended use.



GIROTRI1
(Dark Grey)



GIROTRI2
(White)

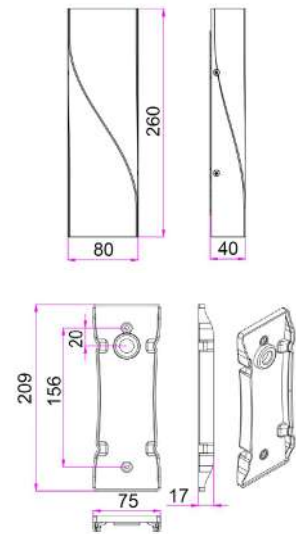

Back plate

Part No.	GIROTRI1, GIROTRI2
Description	WALL S/M Up/Dn 11W LED Tri Twist Alt Beam
Material	Aluminium & PC
Kelvin	3000K/ 4000K/ 6500K
Lumens	907LM/ 1103LM/ 957LM
Wattage	11W
Power Factor	>0.8
CRI	>80
Dimensions	L260 x W80 x D40mm
Back plate	209x75x17mm
Carton QTY	1/12

- Exterior LED surface mounted up/down wall lights
- Input voltage: 100-240V AC 50/60Hz
- Inbuilt Constant Current driver included
- Housing & heatsink: aluminium
- Diffuser: PC
- Back plate: aluminium
- LED chips: 8pcs 3030
- Tri-CCT (3000K/ 4000K/ 6500K) in one fitting
- CCT switch inside the fitting
- 2 stickers included which allow narrowing of beam angle at both or either end
- Beam angle: without sticker is 117° and with the sticker is 68.9°
- Ambient temperature: -20 to 50°C
- Not suitable for dimming
- Suitable for 2 way switching
- Suitable for use with PIR sensor



*To avoid disappointment and warranty problems, please ensure the IP Rating of the chosen product is relevant for the intended use.

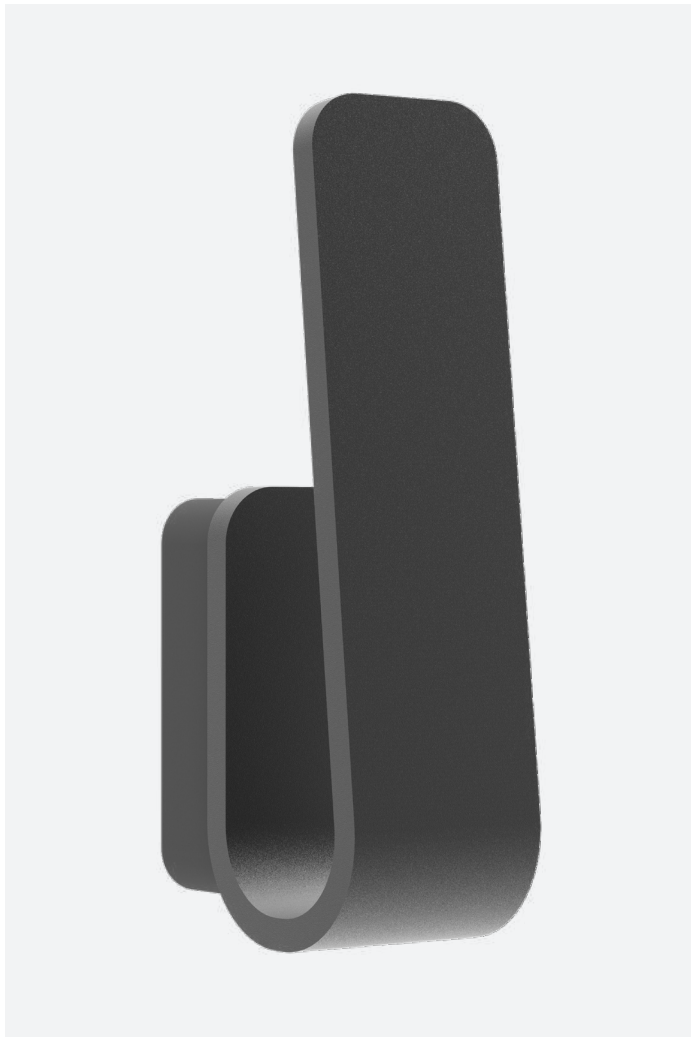
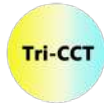

HAK1
(Dark Grey)



HAK2
(White)

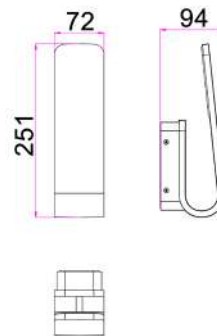

- Input voltage: 100-240V 50/60Hz
- Inbuilt Constant Current LED driver
- Surface mounted
- Housing: Powder coated aluminium
- Heat sink: aluminium
- Mounting plate: PC
- Tri-CCT (3000K/ 4000K/ 6500K) in one fitting
- CCT switch inside the fitting
- LED chips: 84pcs SMD2835
- CRI: >80
- Power factor: >0.8
- Ambient temperature: -20 to 50°C
- Not suitable for dimming
- Suitable for 2-way switching
- Suitable for use with PIR or Microwave sensor

		IP65 Rated	3YEAR Replacement Warranty
--	--	----------------------	---

Part No.	HAK1, HAK2
Description	WALL S/M 7W LED TRI 536 Lm IP65 Hook
Material	Aluminium & PC
Kelvin	3000K/ 4000K/ 6500K
Lumens	482LM/ 534LM/ 536LM
Wattage	7W
Power Factor	>0.8
CRI	>80
Dimensions	L251 x W72 x D94mm
Back plate	125x63mm
Carton QTY	1/8

*To avoid disappointment and warranty problems, please ensure the IP Rating of the chosen product is relevant for the intended use.

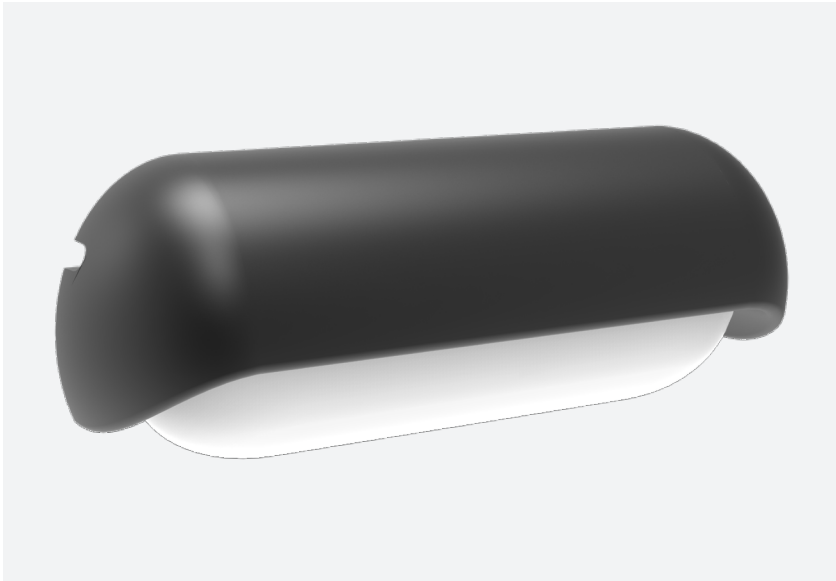

AKENTRI1
(Dark Grey)

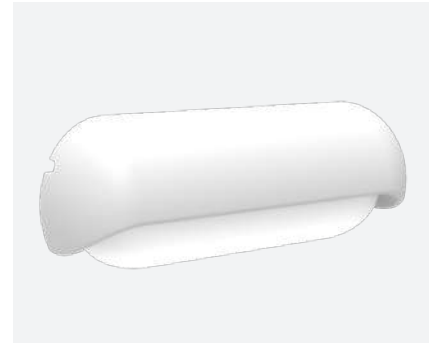

AKENTRI2
(White)

- Exterior LED surface mounted eyelid wall lights
- Input voltage range: 100-240V AC 50/60Hz
- Inbuilt Constant Current driver included
- Housing & heat sink: powder coated aluminium
- Diffuser & back plate: PC
- LED chips: 24pcs SMD2835
- Tri-CCT (3000K/ 4000K/ 6500K) in one fitting
- CCT switch inside of the fitting
- Ambient temperature: -20 to 50°C
- Not suitable for dimming
- Suitable for 2-way switching
- Suitable for use with PIR or Microwave sensors

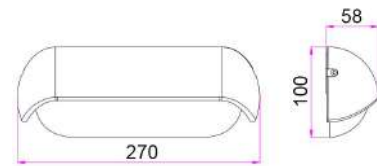

30,000hr Lifetime	111° Beam Angle	IP65 Rated	3YEAR Replacement Warranty
----------------------	--------------------	----------------------	---



Part No.	AKENTRI1, AKENTRI2
Description	WALL S/M Rect LED Tri Eyelid Opal Diffuser
Material	Aluminium & PC
LED chips	24pcs SMD2835
Kelvin	3000K/ 4000K/ 6500K
Lumens	759LM/ 908LM/ 875LM
Wattage	13W
Power factor	>0.5
CRI	>80
Beam angle	111°
Dimensions	L 270 x H 100 x D 58mm
Back plate	270x100mm
Carton QTY	1/8

*To avoid disappointment and warranty problems, please ensure the IP Rating of the chosen product is relevant for the intended use.



REPISATRI1
(Dark Grey)



REPISATRI2
(White)

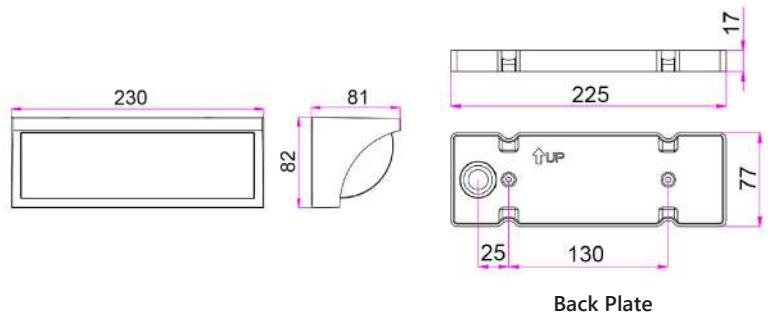

Back Plate

- Input voltage: 100-240V 50/60Hz
- Inbuilt Constant Current LED driver
- Housing & heatsink: aluminium
- White diffuser: UV resistant PC
- Back plate: aluminium
- LED chips: 32pcs SMD2835
- Tri-CCT (3000K/ 4000K/ 6500K) in one fitting
- CCT switch inside the fitting
- Ambient temperature: -20 to 50°C
- Not suitable for dimming
- Suitable for 2 way switching
- Suitable for use with PIR sensor

Part No.	REPISATRI1, REPISATRI2
Description	WALL S/M LED Dark Grey / WH Curved Wedge
Material	Aluminium & PC
Kelvin	3000K/ 4000K/ 6500K
Lumens	933LM/ 1040LM/ 1016LM
Wattage	13W
Power Factor	>0.8
CRI	>80
Dimensions	L230 x W82 x D81mm
Back plate	225x77x17mm
Carton QTY	1/8

30,000hr
Lifetime

120°
Beam Angle

IP65
Rated

3YEAR
Replacement
Warranty

*To avoid disappointment and warranty problems, please ensure the IP Rating of the chosen product is relevant for the intended use.



TOPPATRI1
(Dark Grey)



TOPPATRI2
(White)

- Exterior LED surface mounted wall lights
- Input voltage range: 100-240V AC 50/60Hz
- Inbuilt constant current driver included
- Housing & heatsink: aluminium
- Diffuser & back plate: PC
- Tri-CCT (3000K/ 4000K/ 6500K) in one fitting
- CCT switch inside the fitting
- LED chips: 24pcs SMD2835
- Ambient temperature: -20 to 50°C
- Not suitable for dimming
- Suitable for 2-way switching
- Suitable for use with PIR or Microwave sensors

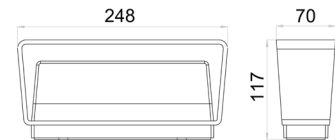

30,000hr Lifetime	304° Beam Angle	IP65 Rated	3YEAR Replacement Warranty
----------------------	--------------------	----------------------	---

Part No.	TOPPATRI1, TOPPATRI2
Description	WALL LED S/M RECT (RND) Up/Dn IP65 + RECT Base
Material	Aluminium & PC
LED chips	24pcs SMD2835
Kelvin	3000K/ 4000K/ 6500K
Lumens	678LM/ 796LM/ 776LM
Wattage	13W
Power factor	>0.8
CRI	>80
Beam angle	304°
Dimensions	L 248 x W 70 x D 117mm
Carton QTY	1/12

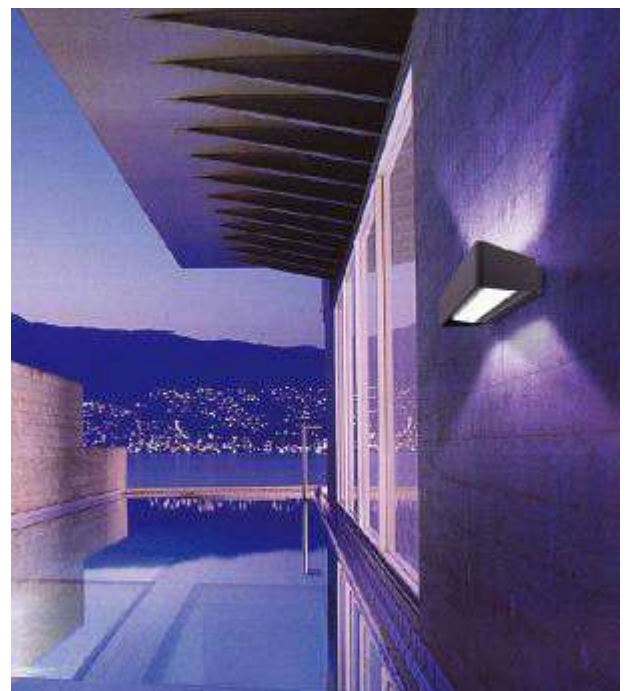

EXTERIOR LIGHTING

**To avoid disappointment and warranty problems, please ensure the IP Rating of the chosen product is relevant for the intended use.*

Bocina Exterior Lighting



BOCINA01
(Dark Grey)

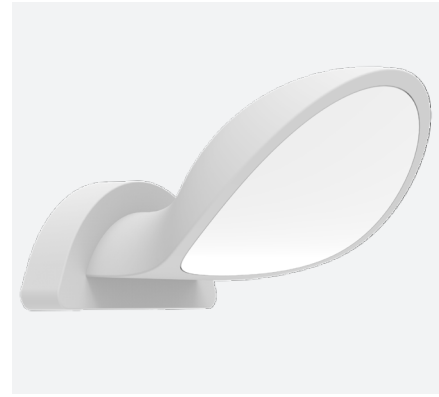

BOCINA02
(White)

- Exterior LED surface mounted semicircle wall lights
- Input voltage range: 100-240V AC 50/60Hz
- Inbuilt Constant Current driver included
- Housing & heatsink: aluminium
- Diffuser: UV resistant PC
- Back plate: aluminium
- LED chips: 14pcs SMD2835
- Ambient temperature: -20 to 50°C
- Not suitable for dimming
- Suitable for 2 way switching
- Suitable for use with PIR sensor

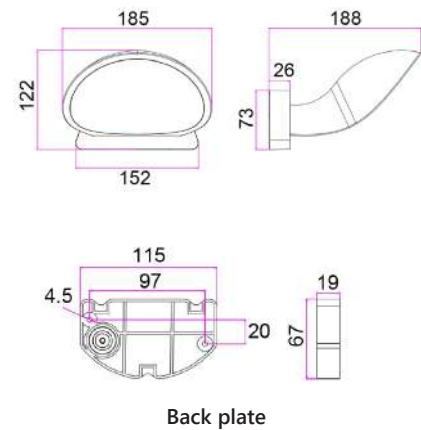

Part No.	BOCINA01, BOCINA02
Description	WALL LED S/M Hood IP65 + Semi Circular Base
Material	Aluminium & PC
LED chips	14pcs SMD2835
Kelvin	3000K
Lumens	430LM
Wattage	10W
Power factor	>0.5
CRI	>80
Beam angle	116°
Dimensions	Please see the line drawing
Back plate	115x67x19mm
Carton QTY	1/8



*To avoid disappointment and warranty problems, please ensure the IP Rating of the chosen product is relevant for the intended use.

Plana Exterior Lighting

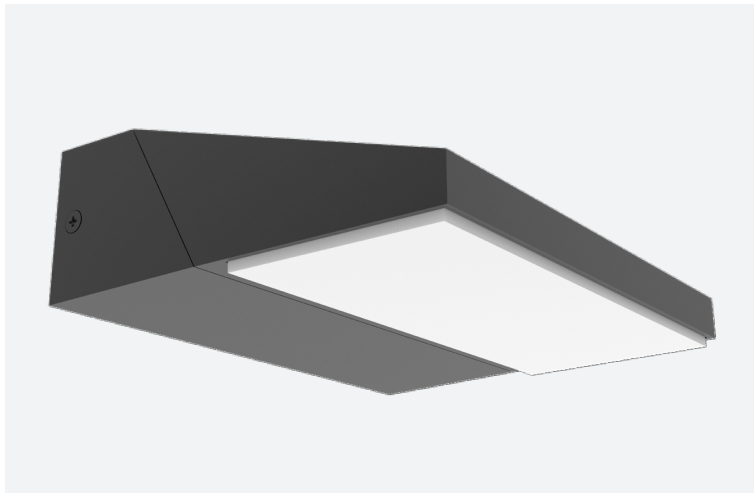

PLANA01
(Dark Grey)

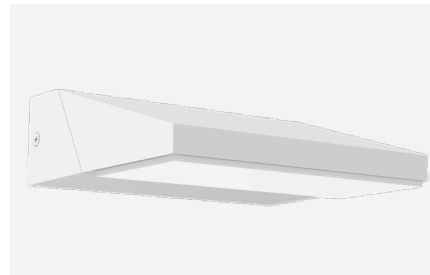

PLANA02
(White)



Degree of Swivel: 180°

- Exterior LED adjustable surface mounted wall lights
- Input voltage: 100-240V AC 50/60Hz
- Inbuilt Constant Current driver included
- Housing & heatsink: aluminium
- Diffuser: UV resistant PC
- Back plate: aluminium
- Degree of Swivel: 180°
- LED chips: 12pcs 2835
- Ambient temperature: -20 to 50°C
- Not suitable for dimming
- Suitable for 2 way switching
- Suitable for use with PIR sensor

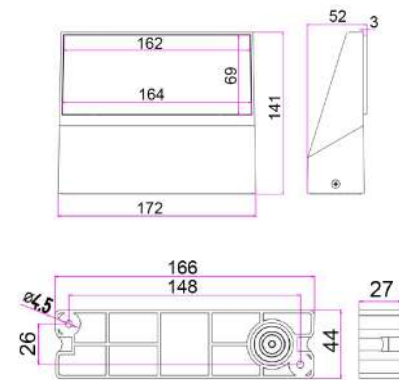

Back plate

		IP65 Rated	3YEAR Replacement Warranty
--	--	----------------------	---

Part No.	PLANA01, PLANA02
Description	WALL LED S/M Wedge Swivel IP65 + RECT Base
Material	Aluminium & PC
LED chips	12pcs 2835
Kelvin	3000K
Lumens	650LM
Wattage	13W
Power factor	>0.9
CRI	>80
Beam angle	127°
Back plate	166x44x27mm
Carton QTY	1/8



*To avoid disappointment and warranty problems, please ensure the IP Rating of the chosen product is relevant for the intended use.

Sombra Exterior Lighting



SOMBRA01
(Dark Grey)



SOMBRA02
(White)

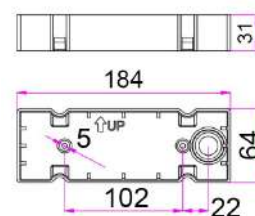
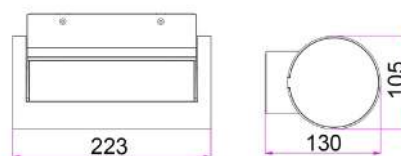

Back plate

- Exterior LED adjustable eyelid surface mounted wall lights
- Input voltage range: 100-240V AC 50/60Hz
- Inbuilt Constant Current driver included
- Housing & heatsink: aluminium
- Diffuser: UV resistant PC
- Back plate: aluminium
- Power factor: >0.9
- CRI: >80
- 180° adjustable cap
- LED chips: 12pcs 3030
- Ambient temperature: -20 to 50°C
- Not suitable for dimming
- Suitable for 2-way switching
- Suitable for use with PIR sensor



Part No.	SOMBRA01, SOMBRA02
Description	WALL LED S/M Cylinder Rotating IP65 + RECT Base
Material	Aluminium & PC
LED chips	12pcs 3030
Kelvin	3000K
Lumens	380LM
Wattage	13W
Power factor	>0.9
CRI	>80
Dimensions	Please see the line drawing
Back plate	184x64x31mm
Carton QTY	1/8

*To avoid disappointment and warranty problems, please ensure the IP Rating of the chosen product is relevant for the intended use.

Wig Exterior Lighting

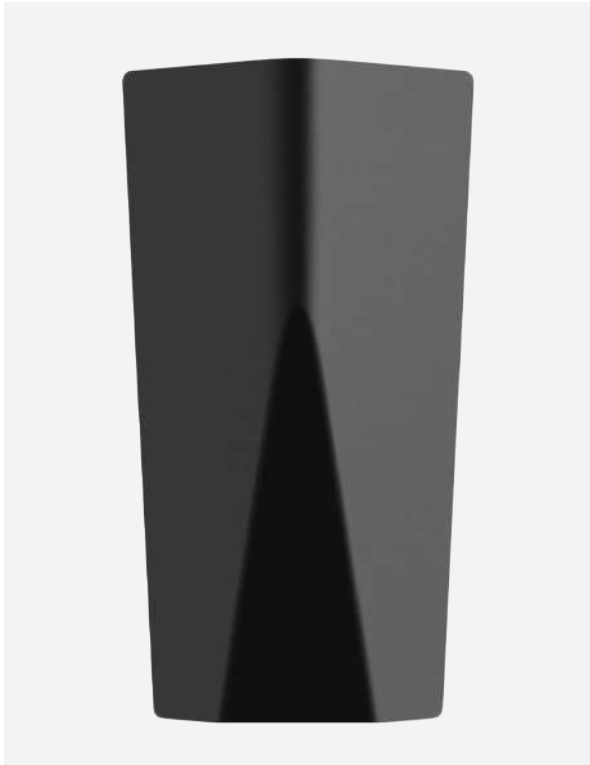

WIG1
(Dark Grey)



WIG2
(White)

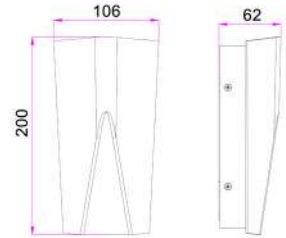

- Exterior LED surface mounted up/down wall lights
- Input voltage range: 100-240V AC 50/60Hz
- Output voltage range: 18-42V DC
- Housing: powder coated aluminium
- Bracket: PC
- 2 stickers included which allow narrowing of beam angle at both or either end
- Beam angle: without sticker is 69.9° and with the sticker is 32.7°
- Ambient temperature: -20 to 50°C
- Not suitable for dimming
- Suitable for 2-way switching
- Suitable for use with PIR or Microwave sensors



Part No.	WIG1, WIG2
Description	WALL LED S/M Wedge Up/Dn IP65 + Flush Base
Material	Aluminium
LED chips	2pcs 5050
Kelvin	3000K
Lumens	550LM
Wattage	11W
Power factor	>0.5
CRI	80
Dimensions	200 x 106mm
Carton QTY	1/8



EXTERIOR LIGHTING

*To avoid disappointment and warranty problems, please ensure the IP Rating of the chosen product is relevant for the intended use.

Bes Exterior Lighting



BES1
(Dark Grey)



BES2
(White)

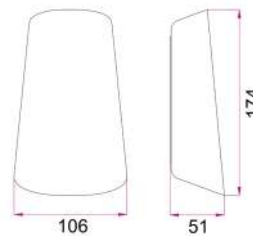

Height: 174mm
 Width of the TOP: 77mm
 Depth of the TOP: 35mm
 Width of the BOTTOM: 106mm
 Depth of the BOTTOM: 51mm

- Exterior LED surface mounted up/down wall lights
- Input voltage range: 100-240V AC 50/60Hz
- Housing: aluminium
- Diffuser: glass
- Back plate: PC
- Ambient temperature: -20 to 50°C
- Not suitable for use with dimmers
- Suitable for 2-way switching
- Suitable for use with PIR or Microwave sensors



Part No.	BES1, BES2
Description	WALL LED S/M Curved Up/Dn IP65 + Flush Base
Material	Aluminium, PC & glass
LED chips	2pcs 5050
Kelvin	3000K
Lumens	368LM
Wattage	11W
Power factor	>0.5
CRI	>80
Beam angle	120°
Dimensions	L 174 x W 106 x D 51mm
Carton QTY	1/18



**To avoid disappointment and warranty problems, please ensure the IP Rating of the chosen product is relevant for the intended use.*

Ola Exterior Lighting



OLA01
(Dark Grey)



OLA02
(White)

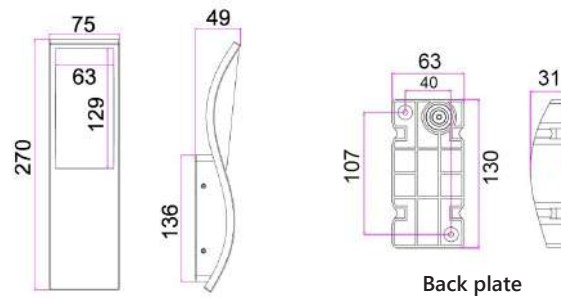

Back plate

- Exterior LED surface mounted wall lights
- Input voltage range: 100-240V AC 50/60Hz
- Inbuilt Constant Current driver included
- Housing & heatsink: aluminium
- White diffuser: UV resistant PC
- Back plate: aluminium
- Ambient temperature: -20 to 50°C
- Not suitable for dimming
- Suitable for 2 way switching
- Suitable for use with PIR sensor



Part No.	OLA01, OLA02
Description	WALL LED S/M RECT (Wavy) IP65 + RECT Base
Material	Aluminium & PC
LED chips	48pcs 2835
Kelvin	3000K
Lumens	509LM
Wattage	7W
Power factor	>0.8
CRI	>80
Back plate	130x63x31mm
Carton QTY	1/12

*To avoid disappointment and warranty problems, please ensure the IP Rating of the chosen product is relevant for the intended use.

Glans Exterior Lighting



GLANS01 - Small
GLANS03 - Large
(Dark Grey)



GLANS02 - Small
GLANS04 - Large
(White)

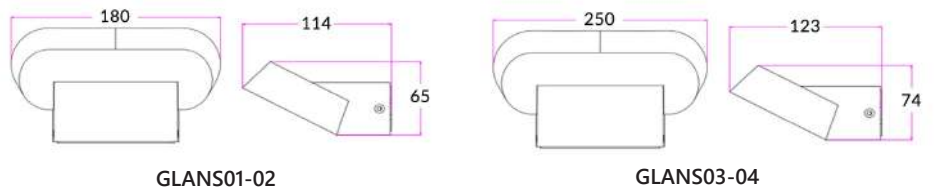

- Exterior LED surface mounted wall lights
- Input voltage range: 100-240V AC 50/60Hz
- Output voltage: 13.5-22V
- Housing & heat sink: aluminium
- Mounting bracket & diffuser: PC
- LED chips: 6pcs or 12pcs 3030 LED
- Power factor: >0.5
- Ambient temperature: -20 to 50°C
- Not suitable for dimming
- Suitable for 2-way switching
- Suitable for use with PIR or Microwave sensors

30,000hr
Lifetime

IP65
Rated

3YEAR
Replacement
Warranty



Part No.	Description	Kelvin	Lumens	Watt	CRI	LED Chips	Beam Angle	Dimensions	Carton QTY
GLANS01	WALL LED Dark Grey 7W	3000K	180LM	7	80	6pcs 3030	111.6°	180x65x114mm	1/8
GLANS02	WALL LED White 7W	3000K	180LM	7	80	6pcs 3030	111.6°	180x65x114mm	1/8
GLANS03	WALL LED Dark Grey 13W	3000K	330LM	13	80	12pcs 3030	112.3°	250x74x123mm	1/8
GLANS04	WALL LED White 13W	3000K	330LM	13	80	12pcs 3030	112.3°	250x74x123mm	1/8

*To avoid disappointment and warranty problems, please ensure the IP Rating of the chosen product is relevant for the intended use.

Apis Exterior Lighting

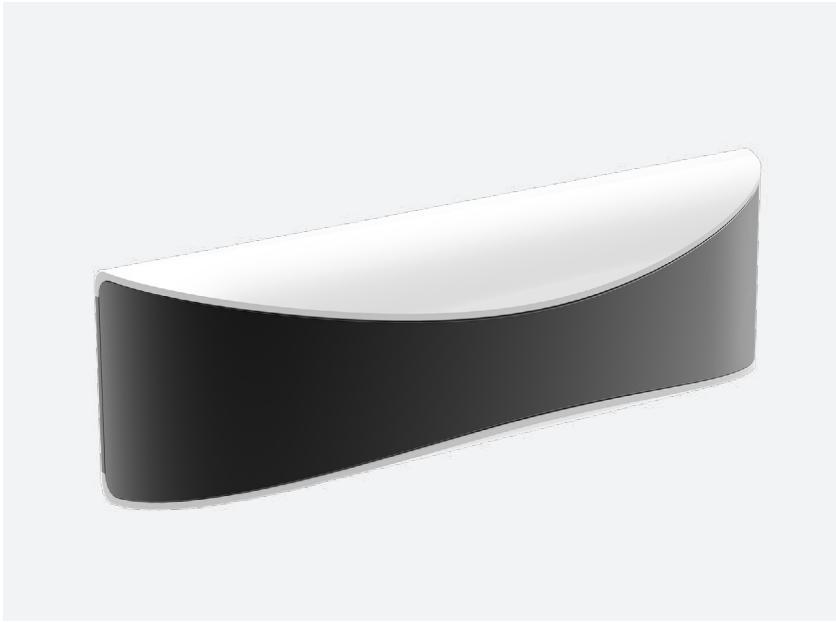

APIS1
(Dark Grey)



APIS2
(White)

- Exterior LED surface mounted up/down wall lights
- Input voltage range: 220-240V AC 50/60Hz
- Inbuilt Constant Current driver included
- Shade, diffuser & bracket: PC
- LED chips: 50pcs 2835
- Power factor: 0.5
- Ambient temperature: -20 to 50°C
- Not suitable for dimming
- Suitable for 2-way switching
- Suitable for use with PIR or Microwave sensors

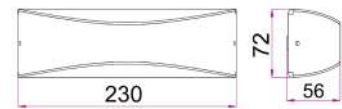

Part No.	APIS1, APIS2
Description	WALL LED S/M Crescent (Reverse) Up/ Dn IP65 + Flush Base 10W 120D 3K
Material	PC
LED chips	50pcs 2835
Kelvin	3000K
Lumens	275.75LM
Wattage	10W
Power factor	0.5
CRI	>80
Beam angle	120°
Dimensions	L 230 x W 72 x D 56mm
Back plate	230x72mm
Carton QTY	1/8

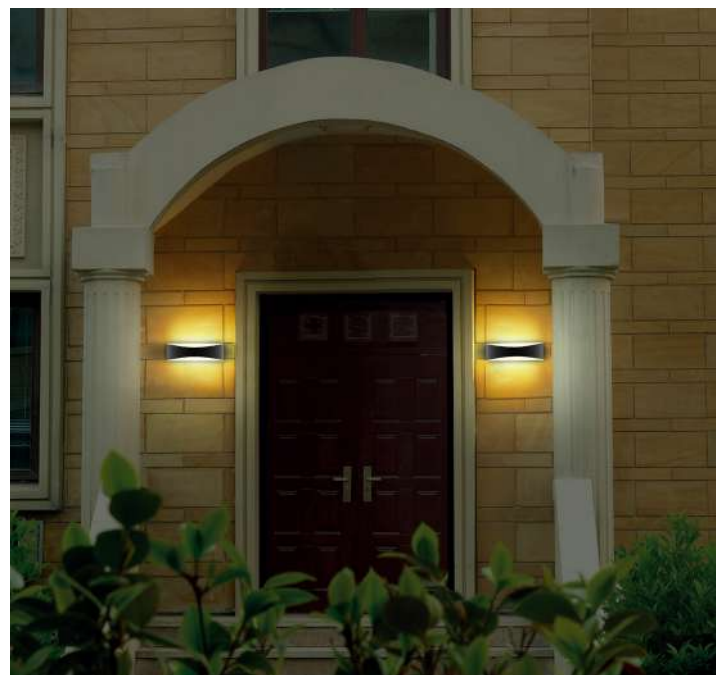

**To avoid disappointment and warranty problems, please ensure the IP Rating of the chosen product is relevant for the intended use.*

Aten Exterior Lighting



ATEN1
(Matte Black)

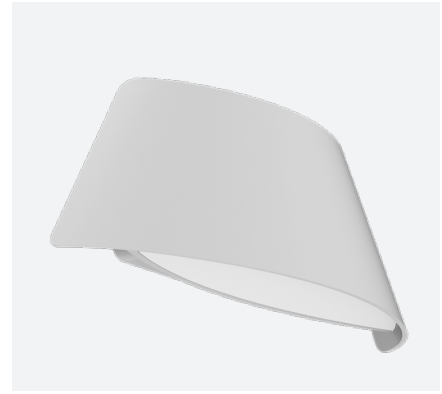

ATEN2
(Matte White)

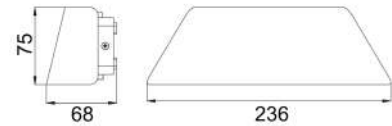

- Exterior LED surface mounted up/down lights
- Input voltage range: 100-240V AC 50/60Hz
- Housing: aluminium
- Diffuser: PC
- Ambient temperature: -20 to 50°C
- Not suitable for use with dimmers
- Suitable for 2-way switching
- Suitable for use with PIR or Microwave sensors



Part No.	ATEN1, ATEN2
Description	WALL LED S/M Curved Up/Dn IP65 M/BLK + FLUSH Base 9W
Material	Aluminium & PC
LED chips	8pcs 3030
Kelvin	3000K
Lumens	531LM
Wattage	9W
Power factor	>0.5
CRI	>80
Beam angle	120°
Dimensions	L 236 x W 75 x D 68mm
Back plate	135x50x8mm
Carton QTY	1/9



*To avoid disappointment and warranty problems, please ensure the IP Rating of the chosen product is relevant for the intended use.

Marina Exterior Lighting



MARINA1
(Dark Grey)

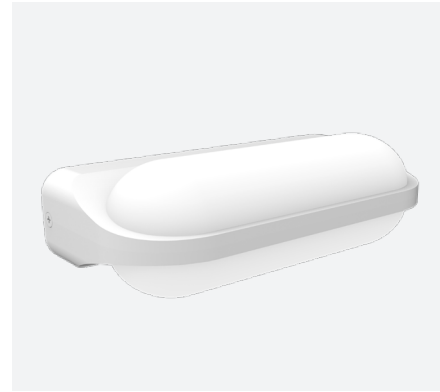

MARINA2
(White)

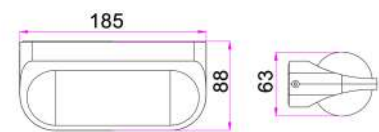

- Exterior LED surface mounted up/down wall lights
- Input voltage range: 100-240V AC 50/60Hz
- Output voltage range: 13.5-22V DC
- Housing: aluminium
- Diffuser & bracket: PC
- Ambient temperature: -20 to 50°C
- Not suitable for dimming
- Suitable for 2-way switching
- Suitable for use with PIR & Microwave sensors



Part No.	MARINA1, MARINA2
Description	WALL LED S/M Oval Up/Dn IP65 + Flush Base
Material	Aluminium & PC
LED chips	6pcs 3030
Kelvin	3000K
Lumens	380LM
Wattage	7W
Power factor	>0.5
CRI	80
Beam angle	173°
Dimensions	L 185 x W 63 x D 88mm
Back plate	92.5x50.5mm
Carton QTY	1/8



**To avoid disappointment and warranty problems, please ensure the IP Rating of the chosen product is relevant for the intended use.*

Heka Exterior Lighting



HEKA1
(Dark Grey)



HEKA2
(White)

- Exterior LED surface mounted wall lights
- Input voltage range: 100-240V AC 50/60Hz
- Inbuilt constant current driver included
- Housing & heatsink: aluminium
- Diffuser & back plate: PC
- Ambient temperature: -20 to 50°C
- Not suitable for dimming
- Suitable for 2-way switching
- Suitable for use with PIR or Microwave sensors

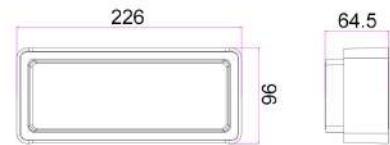

30,000hr Lifetime	120° Beam Angle	IP65 Rated	3YEAR Replacement Warranty
----------------------	--------------------	----------------------	---

Part No.	HEKA1, HEKA2
Description	WALL LED S/M RECT 3 Way IP65 + Flush Base
Material	Powder coated aluminium & PC
LED chips	12pcs 3030
Kelvin	3000K
Lumens	732.94LM
Wattage	13W
Power factor	>0.5
CRI	>80
Beam angle	120°
Dimensions	L 226 x W 96 x D 64.5mm
Back plate	197x65mm
Carton QTY	1/8



*To avoid disappointment and warranty problems, please ensure the IP Rating of the chosen product is relevant for the intended use.



KUK1
(Dark Grey)

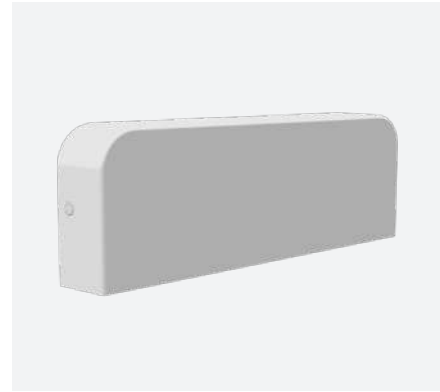

KUK2
(White)

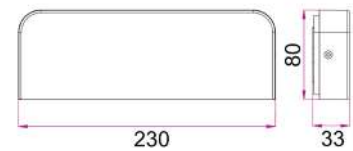

- Exterior LED surface mounted wall lights
- Input voltage range: 100-240V 50/60Hz
- Shade & heatsink: aluminium
- Diffuser & bracket: PC
- Shade internal colour: white
- LED chips: 50pcs 2835
- Ambient temperature: -20 to 50°C
- Not suitable for dimming
- Suitable for 2 way switching
- Suitable for use with PIR or Microwave sensors



Part No.	KUK1, KUK2
Description	WALL LED S/M RECT (RND) IP54 + Flush Base
Material	Aluminium & PC
LED chips	50pcs 2835
Kelvin	3000K
Lumens	670LM
Wattage	10W
Power factor	>0.5
CRI	>80
Beam angle	120°
Dimensions	L 230 x W 80 x D 33mm
Back plate	220x70mm
Carton QTY	1/12

**Unless protected, not recommended for environments with harsh weather conditions or heavy rainfall. IP65 fittings recommended for such environments. To avoid disappointment and warranty problems, please ensure the IP Rating of the chosen product is relevant for the intended use.*

Toca Exterior Lighting



TOCA1
(Black)



TOCA2
(White)

Adjustable beam angle:

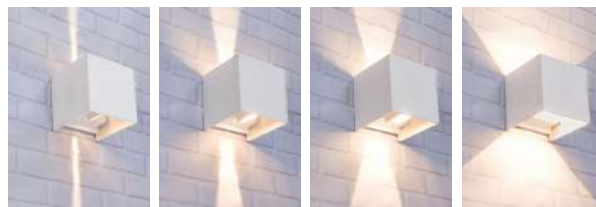

- Exterior LED surface mounted up/down wall lights
- With adjustable beam angle
- Input voltage range: 220-240V AC 50/60Hz
- Material: aluminium
- LED chips: 18pcs SMD2835
- Ambient temperature: -20 to 50°C
- Not suitable for dimming
- Suitable for 2-way switching
- Suitable for use with PIR & Microwave sensors



Part No.	TOCA1, TOCA2
Description	WALL LED S/M Cube Up/Dn with Adjustable Lens Covers IP54 + Flush Base
Material	Aluminium
LED chips	18pcs SMD2835
Kelvin	3000K
Lumens	408LM
Wattage	6.8W
Power factor	≥0.5
CRI	80
Dimensions	L 100 x W 100 x D 100mm
Carton QTY	1/12



*Unless protected, not recommended for environments with harsh weather conditions or heavy rainfall. IP65 fittings recommended for such environments. To avoid disappointment and warranty problems, please ensure the IP Rating of the chosen product is relevant for the intended use.



TOCA3
(Matte Black)



TOCA4
(Matte White)

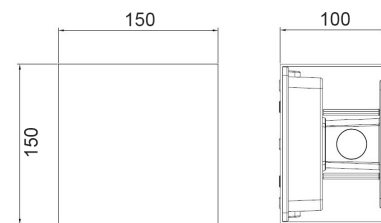

- Exterior LED surface mounted up/down lights
- With adjustable lens covers
- Input voltage range: 200-240V
- Inbuilt driver
- Housing: powder coated aluminium
- Diffuser: frosted glass
- Mounting plate: aluminium
- LED chips: 2pcs COB
- Ambient temperature: -20 to 50°C
- Not suitable for dimming
- Suitable for 2-way switching
- Suitable for use with Microwave or PIR sensors



Part No.	TOCA3, TOCA4
Description	WALL LED S/M Cube Up/Dn with Adjustable Lens Covers IP65+Flush Base
Material	Aluminium & glass
LED chips	2pcs COB
Kelvin	3000K
Lumens	940LM
Wattage	20W
Power factor	0.9
CRI	80
Beam angle	120°
Dimensions	L 150 x W 150 x D 100mm
Back plate	W 130 x H 110mm
Carton QTY	1/6

**To avoid disappointment and warranty problems, please ensure the IP Rating of the chosen product is relevant for the intended use.*



VOX1
(Black)



VOX2
(White)



VOX3
(Polished Aluminium)

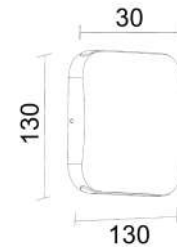

- Exterior LED surface mounted up/down wall lights
- Input voltage range: 100-240V AC 50/60Hz
- Output voltage range: 5.5-30V
- Housing & bracket: aluminium
- Ambient temperature: -20 to 45°C
- Not suitable for dimming
- Suitable for 2-way switching
- Suitable for use with PIR & Microwave sensors



30,000hr
Lifetime



120°
Beam Angle

IP54
Rated

2YEAR
Replacement
Warranty

Part No.	VOX1, VOX2, VOX3
Description	WALL LED S/M Squirle Up/Dn IP54+ Flush Base
Material	Aluminium
LED chips	32pcs SMD2835
Kelvin	3000K
Lumens	VOX1-2: 808LM; VOX3: 737LM
Wattage	9W
Power factor	>0.5
CRI	80
Beam angle	120°
Dimensions	L 130 x W 130 x D 30mm
Back plate	130x130mm
Carton QTY	1/8

**Unless protected, not recommended for environments with harsh weather conditions or heavy rainfall. IP65 fittings recommended for such environments. To avoid disappointment and warranty problems, please ensure the IP Rating of the chosen product is relevant for the intended use.*

Tama & Remo Exterior Lighting



TAMA1
(Black)



TAMA2
(White)

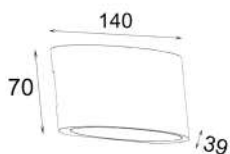

- Exterior LED surface mounted up/down wall lights
- Input voltage range: 220-240V AC 50/60Hz
- Shade & bracket: aluminium
- Diffuser: PC
- Ambient temperature: -20 to 50°C
- Not suitable for dimming
- Suitable for 2-way switching
- Suitable for use with PIR & Microwave sensors



Part No.	TAMA1, TAMA2
Description	WALL LED S/M RECT (RND) Up/Dn IP54 + Flush Base
Material	Aluminium & PC
LED chips	18pcs 2835
Kelvin	3000K
Lumens	605LM
Wattage	6.8W
Power factor	>0.5
CRI	80
Back plate	92.5x50.5mm
Carton QTY	1/24



REMO1
(Black)



REMO2
(White)

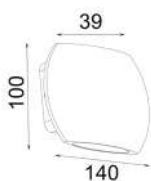

- Exterior LED surface mounted up/down wall lights
- Input voltage range: 220-240V AC 50/60Hz
- Shade & bracket: aluminium
- Diffuser: PC
- Ambient temperature: -20 to 50°C
- Not suitable for dimming
- Suitable for 2-way switching
- Suitable for use with PIR & Microwave sensors



Part No.	REMO1, REMO2
Description	WALL LED S/M RECT (RND) Up/Dn IP54 + Flush Base
Material	Aluminium & PC
LED chips	18pcs 2835
Kelvin	3000K
Lumens	500LM
Wattage	6.8W
Power factor	>0.5
CRI	80
Back plate	84x51mm
Carton QTY	1/24

*Unless protected, not recommended for environments with harsh weather conditions or heavy rainfall. IP65 fittings recommended for such environments. To avoid disappointment and warranty problems, please ensure the IP Rating of the chosen product is relevant for the intended use.

Wedge Exterior Lighting



WEDGEGBL
(SS 316 Powder Coated Black)



WEDGEGC
(Copper)



WEDGEGSS
(SS 316)



WEDGEGWH
(SS 316 Powder Coated White)

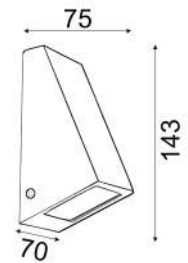

- Exterior surface mounted wall wedge lights
- Input voltage range: 110-265V AC 50/60Hz
- Material: 316 stainless steel & copper
- Diffuser: glass
- Lamp holder: GU10 (Max. 35W)
- Globes not included

 GU10	IP44 Rated	2 YEAR Replacement Warranty
---	----------------------	--

Part No.	WEDGEGBL, WEDGEGC, WEDGEGSS, WEDGEGWH
Description	WALL S/M Wedge IP44 + Flush Base
Material	SS 316 / Copper
Lamp holder	1xGU10 (Max.35W)
Dimensions	L 143 x W 70 x D 75mm
Back plate	143x70mm
Carton QTY	1/20



**Unless protected, not recommended for environments with harsh weather conditions or heavy rainfall. IP65 fittings recommended for such environments. To avoid disappointment and warranty problems, please ensure the IP Rating of the chosen product is relevant for the intended use.*

Ned Exterior Lighting



NED01
(Solid Copper)



NED02
(316 Stainless Steel)

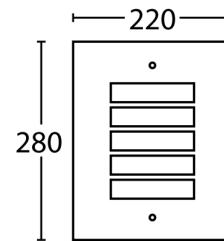

- Exterior surface mounted wall lights
- Input voltage range: 110-265V AC 50/60Hz
- Faceplate: 316 stainless steel or solid copper
- Housing & Diffuser: PC
- Lamp holder: 1xE27 (Max.60W)
- Globes not included



Part No.	NED01, NED02
Description	WALL ES 60W S/M RECT with Grill IP54 + Flush Base
Material	Faceplate: Copper/ 316 SS Housing & diffuser: PC
Lamp holder	1xE27 (Max.60W)
Dimensions	W 220 x L 280mm
Carton QTY	1/10



**Unless protected, not recommended for environments with harsh weather conditions or heavy rainfall. IP65 fittings recommended for such environments. To avoid disappointment and warranty problems, please ensure the IP Rating of the chosen product is relevant for the intended use.*

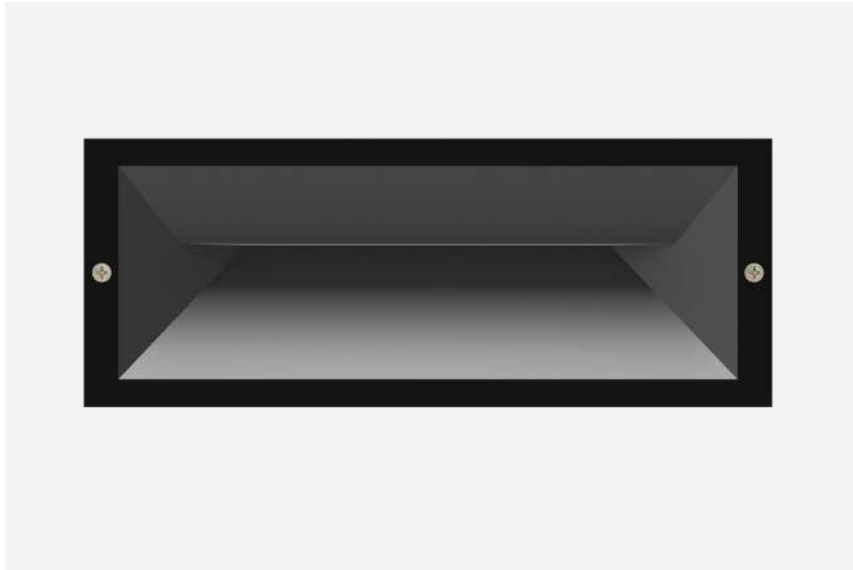

BRICKTRI1
(Dark Grey)



BRICKTRI2
(White)

- Exterior LED recessed wall lights
- Input voltage range: 100-240V AC 50/60Hz
- Internal constant current driver included
- Housing & heatsink: aluminium
- Sleeve & diffuser: PC
- LED chips: 24pcs 2835
- Beam angle: please see below
- Ambient temperature: -20 to 50°C
- Not suitable for dimming
- Suitable for 2 way switching
- Suitable for use with PIR or Microwave sensors

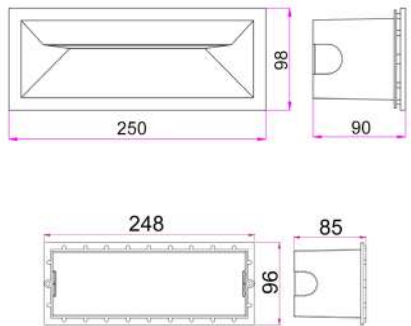

Sleeve line drawing

30,000hr Lifetime	IP65 Rated	3YEAR Replacement Warranty
-------------------	-------------------	-----------------------------------

Part No.	BRICKTRI1-2
Description	WALL LED RECD RECT Eyelid IP65 + Sleeve
Material	Aluminium & PC
LED chips	24pcs 2835
Kelvin	3000K/ 4000K/ 6500K
Lumens	267LM/ 305LM/ 297LM
Wattage	13W
Power factor	>0.8
CRI	>80
Beam angle	67°
Dimensions	L250 x W98 x D90mm
Cut out	L227 x W76 x D78mm
Carton QTY	1/8



*To avoid disappointment and warranty problems, please ensure the IP Rating of the chosen product is relevant for the intended use.

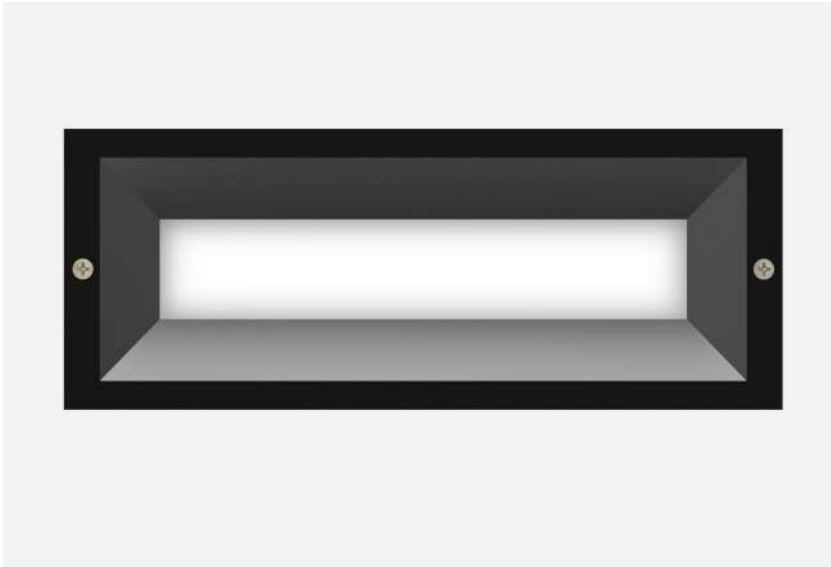

BRICKTRI3
(Dark Grey)

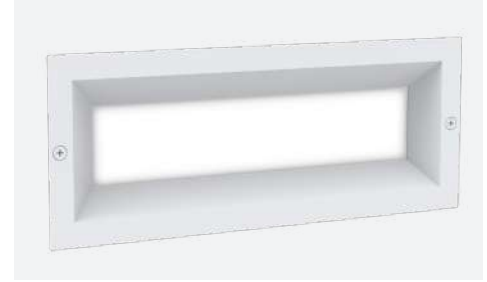

BRICKTRI4
(White)

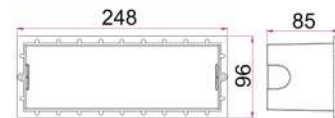
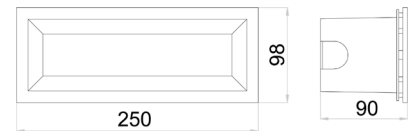

Sleeve line drawing

Part No.	BRICKTRI3-4
Description	WALL LED RECD RECT IP65 + Sleeve
Material	Aluminium & PC
LED chips	24pcs 2835
Kelvin	3000K/ 4000K/ 6500K
Lumens	587LM/ 639LM/ 584LM
Wattage	13W
Power factor	>0.8
CRI	>80
Beam angle	108°
Dimensions	L250 x W98 x D90mm
Cut out	L227 x W76 x D78mm
Carton QTY	1/8

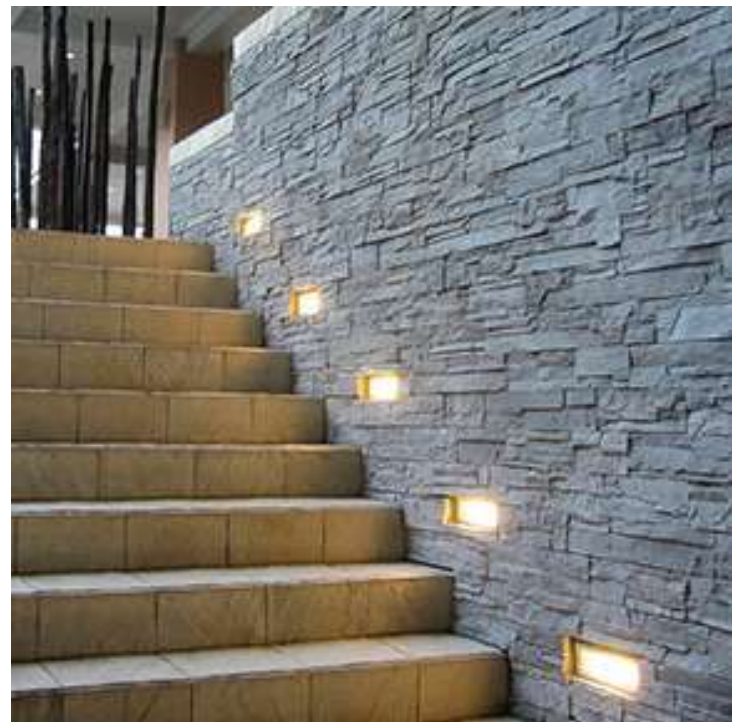

**To avoid disappointment and warranty problems, please ensure the IP Rating of the chosen product is relevant for the intended use.*

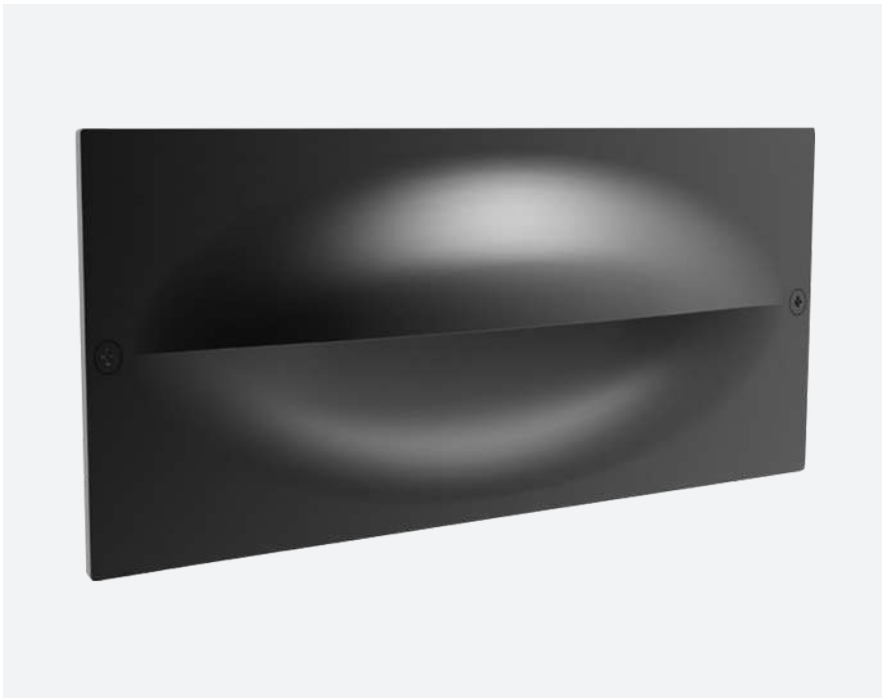

OGATRI1
(Dark Grey)

- Exterior LED recessed wall lights
- Input voltage range: 100-240V AC50/60Hz
- Internal constant current driver included
- Housing & heatsink: aluminium
- Bracket: PC
- LED chips: 24pcs 2835 LED
- Tri-CCT (3000K/ 4000K/ 6500K) in one fitting
- CCT switch inside the fitting
- Power factor: >0.5
- Ambient temperature: -20 to 50°C
- Not suitable for dimming
- Suitable for 2 way switching
- Suitable for use with PIR or Microwave sensors

30,000hr Lifetime	66° Beam Angle	IP65 Rated	3YEAR Replacement Warranty
----------------------	-------------------	----------------------	---

Part No.	OGATRI1, OGATRI2
Description	WALL LED RECT Eyelid IP65 + Sleeve
Material	Aluminium
Kelvin	3000K/ 4000K/ 6500K
Lumens	670LM/ 561LM/ 349LM
Wattage	13W
LED Chips	24pcs 2835
Power factor	>0.8
CRI	>80
Dimensions	L 250 x W 98 x D 105mm
Cut out	230x78mm
Carton QTY	1/8

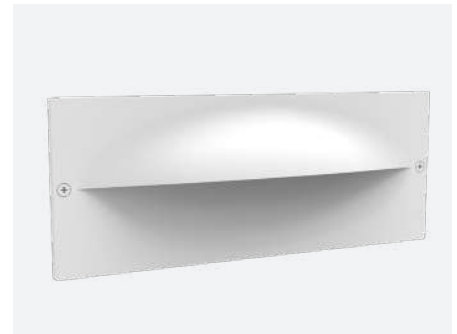

OGATRI2
(White)

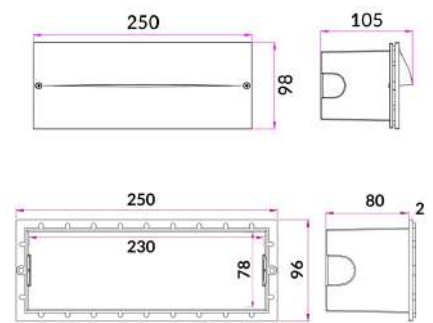

Sleeve line drawing

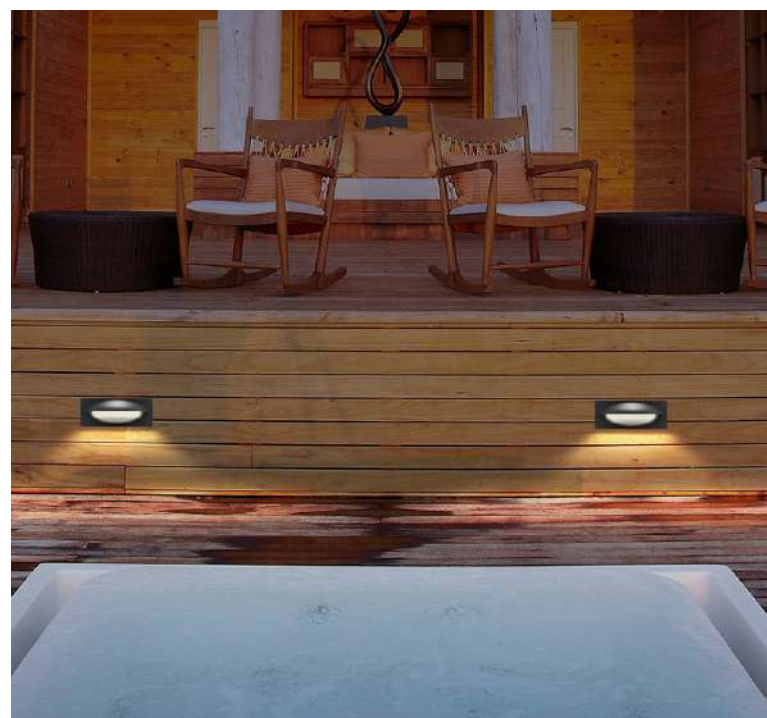

*To avoid disappointment and warranty problems, please ensure the IP Rating of the chosen product is relevant for the intended use.

Bulk Lights Exterior Lighting



BULK1



BULK2

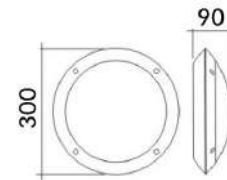

- Exterior LED bulkhead lights
- Input voltage range: 220-240V AC 50/60Hz
- Housing: polycarbonate
- Frosted diffuser & back plate: PC
- LED chips: 63pcs SMD2835
- Ambient temperature: -20 to 45°C
- Double insulated
- IK10 impact rating for Vandal resistance
- Large terminal holes for easy connection
- Not suitable for dimming
- Suitable for 2 way switching
- Suitable for use with PIR or Microwave sensors

30,000hr Lifetime	120° Beam Angle	IP66 Rated	IK10 Rated		3YEAR Replacement Warranty
----------------------	--------------------	----------------------	----------------------	--	---

Part No.	BULK1, BULK2
Description	BULKHEAD/ WALL LED AC RND IP66 IK10 + Flush Base
Material	Polycarbonate
Kelvin	4000K
Lumens	800LM
Wattage	12W
LED Chips	63pcs SMD2835
Power factor	≥0.5
CRI	>80
Dimensions	Ø300 x D 90mm
Carton QTY	1/8



*To avoid disappointment and warranty problems, please ensure the IP Rating of the chosen product is relevant for the intended use.

Bulk Lights Exterior Lighting



BULK3

Part No.	BULK3
Description	BULKHEAD/ WALL LED AC Oval IP66 IK10 BLK + Flush Base
Material	Polycarbonate
Kelvin	4000K
Lumens	800LM
Wattage	12W
LED Chips	63pcs SMD2835
Power factor	≥0.5
CRI	>80
Dimensions	W 230 x L 330 x D 90mm
Carton QTY	1/8



BULK5

Part No.	BULK5
Description	BULKHEAD/ WALL LED AC Square IP66 IK10 + Flush Base
Material	Polycarbonate
Kelvin	4000K
Lumens	800LM
Wattage	12W
LED Chips	63pcs SMD2835
Power factor	≥0.5
CRI	>80
Dimensions	W 280 x L 280 x D 90mm
Carton QTY	1/8



BULK7

Part No.	BULK7
Description	BULKHEAD/ WALL LED AC RND Eyelid IP66 IK10 + Flush Base
Material	Polycarbonate
Kelvin	4000K
Lumens	500LM
Wattage	12W
LED Chips	63pcs SMD2835
Power factor	≥0.5
CRI	>80
Dimensions	Ø300 x D 90mm
Carton QTY	1/8

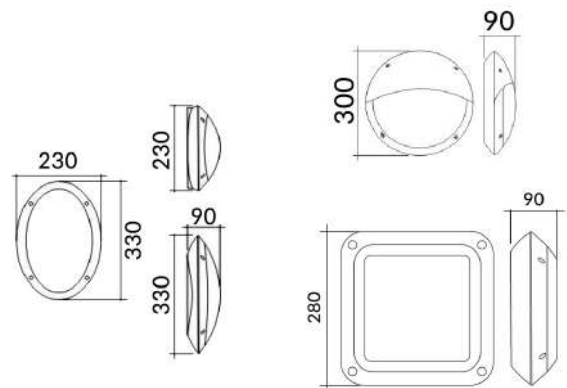

**To avoid disappointment and warranty problems, please ensure the IP Rating of the chosen product is relevant for the intended use.*

Bulk Lights Exterior Lighting



BULK9
(White)



BULK10
(Black)

- Exterior LED bulkhead letter box lights
- Input voltage range: 100-240V AC 50-60Hz
- Internal LED driver
- Shade: aluminium
- Diffuser & back plate: PC
- LED chips: SMD2835
- Power factor: >0.5
- Ambient temperature: -20 to 45°C
- IK10 impact rating for Vandal resistance
- The number stickers are included in the packaging

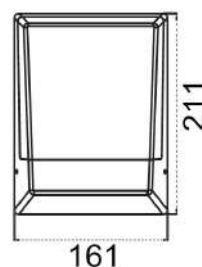

30,000hr Lifetime	117° Beam Angle	IP65 Rated	IK10 Rated	3YEAR Replacement Warranty
----------------------	--------------------	----------------------	----------------------	---

Part No.	BULK9, BULK10
Description	BULKHEAD / WALL / Letterbox RECT Eyelid IP65 IK10 + Flush Base
Material	Die cast aluminium & PC
Kelvin	3000K
Lumens	770LM
Wattage	12W
LED Chips	SMD2835
Power factor	>0.5
CRI	>80
Dimensions	W 161 x L 211 x D 60mm
Carton QTY	1/12



*To avoid disappointment and warranty problems, please ensure the IP Rating of the chosen product is relevant for the intended use.

Bulk Lights Exterior Lighting



BULK11 & BULK12
(Black)



BULK13 & BULK14
(White)



*Optional cage/ Guard removed

- Exterior LED bulkhead lights
- Input voltage range: 190-250V AC 50/60Hz
- Inbuilt LED driver included
- Housing: PC
- Frosted diffuser: PC
- Screw & mounting bracket: iron
- LED chips: 45pcs 2835
- Power factor: ≥ 0.9
- Ambient temperature: -20 to 40°C
- Not suitable for dimming
- Suitable for 2 way switching
- Suitable for use with PIR and Microwave sensor
- Optional cage/guard included

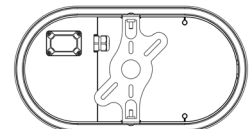
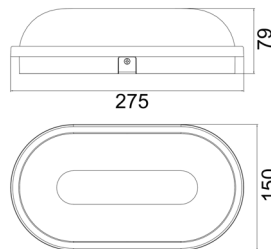

30,000hr
Lifetime

180°
Beam Angle

IP65
Rated

2YEAR
Replacement
Warranty

Part No.	Description	Kelvin	Lumens	Watt	CRI	Power Factor	Dimensions	Carton QTY
BULK11	BULKHEAD / WALL LED BLK OVAL (with opt cage)	3000K	1600LM	20W	80	≥ 0.9	275x150x79mm	1/8
BULK12	BULKHEAD / WALL LED BLK OVAL (with opt cage)	5000K	1700LM	20W	80	≥ 0.9	275x150x79mm	1/8
BULK13	BULKHEAD / WALL LED WH OVAL (with opt cage)	3000K	1600LM	20W	80	≥ 0.9	275x150x79mm	1/8
BULK14	BULKHEAD / WALL LED WH OVAL (with opt cage)	5000K	1700LM	20W	80	≥ 0.9	275x150x79mm	1/8

*To avoid disappointment and warranty problems, please ensure the IP Rating of the chosen product is relevant for the intended use.

Bulk Lights Exterior Lighting



BULK15 & BULK17
(Black)

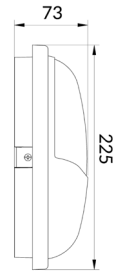

BULK16 & BULK18
(White)



- Exterior LED Eyelid bulkhead lights
- Input voltage range: 180-250V AC 50/60Hz
- Inbuilt constant current driver included
- Material: PC
- Bracket: iron
- Flex: 150mm
- LED chips: 30pcs 2835
- Power factor: ≥ 0.9
- Ambient temperature: -20 to 40°C
- Not suitable for use with dimmers
- Suitable for 2-way switching
- Suitable for use with PIR or Microwave sensors

30,000hr
Lifetime

120°
Beam Angle

IP65
Rated

2YEAR
Replacement
Warranty



Part No.	Description	Kelvin	Lumens	Watt	CRI	Power Factor	Dimensions	Carton QTY
BULK15	BULKHEAD / WALL LED BLK RND Eyelid	3000K	1600LM	20W	80	≥ 0.9	Ø225x73mm	1/10
BULK16	BULKHEAD / WALL LED WH RND Eyelid	3000K	1600LM	20W	80	≥ 0.9	Ø225x73mm	1/10
BULK17	BULKHEAD / WALL LED BLK RND Eyelid	5000K	1600LM	20W	80	≥ 0.9	Ø225x73mm	1/10
BULK18	BULKHEAD / WALL LED WH RND Eyelid	5000K	1600LM	20W	80	≥ 0.9	Ø225x73mm	1/10

*To avoid disappointment and warranty problems, please ensure the IP Rating of the chosen product is relevant for the intended use.

Bulk Lights Exterior Lighting



CLA4736CB



*Flex: 0.6m

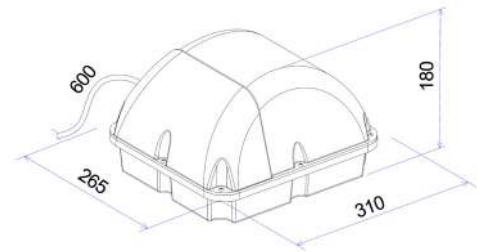

- Exterior LED bulkhead light
- Input voltage range: 220-240V AC
- Housing: powder coated aluminium
- Diffuser: clear PC
- Mounting plate & heatsink: aluminium
- LED chip: 1pc COB
- Power factor: 0.9
- CRI: ≥ 70
- Flex: 0.6m
- Ambient temperature: -20 to 45°C
- Not suitable for dimming
- Suitable for 2 way switching
- Suitable for use with PIR or Microwave sensors

Part No.	CLA4736CB
Description	BULKHEAD / WALL LED AC RECT Eyelid IP65 IK10 BLK + Flush Base
Material	Aluminium & PC
Kelvin	5000K
Lumens	1900LM
Wattage	20W
LED Chips	1PC COB
Power factor	0.9
CRI	≥ 70
Dimensions	L 310 x W 265 x D 180mm
Mounting plate	L 300 x W 265mm
Carton QTY	1/1

 30,000hr Lifetime	 100° Beam Angle	IP65 Rated	IK10 Rated	3YEAR Replacement Warranty
---	---	----------------------	----------------------	---

*To avoid disappointment and warranty problems, please ensure the IP Rating of the chosen product is relevant for the intended use.



OYSDIM001-002

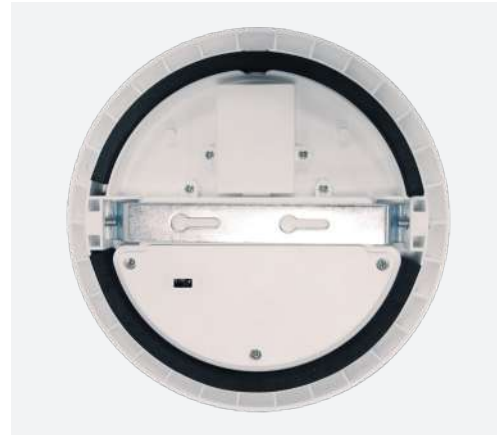

Tri-CCT Switch on Rear

- Waterproof LED Tri-CCT dimmable oyster lights
- Input voltage range: 200-240V AC 50/60Hz
- Inbuilt driver output voltage range: 60-80V
- Material: PC
- Tri-CCT: 3000K/ 4000K/ 5000K in one fitting
- LED chips: SMD2835
- Power factor: >0.9
- CRI: 80
- Ambient temperature: -20 to 40°C
- Suitable for dimming
- Suitable for 2-way switching
- Suitable for use with PIR or microwave sensors
- Suitable for indoor & outdoor use
- Changes to appearance due to climatic conditions not covered under warranty

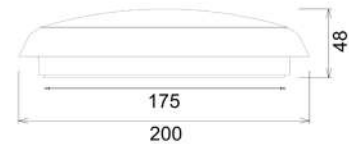
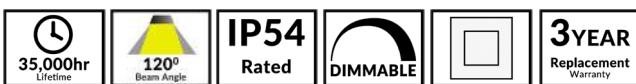

OYSDIM001

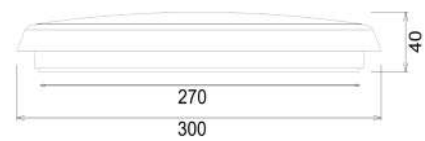

OYSDIM002

Tested & Recommended Dimmers:

Brand	Part No.
CLIPSAL	32ELEDM, 31E2PUDM, 32E450T, 31E450UDM
HPM	CAT250L

Part No.	Lumens			Watt	CRI	Diam	Depth	Back Plate	Carton QTY
	3000K	4000K	5000K						
OYSDIM001	1200LM	1300LM	1250LM	15W	80	Ø200mm	48mm	Ø175mm	1/20
OYSDIM002	2000LM	2200LM	2100LM	24W	80	Ø300mm	40mm	Ø270mm	1/12

*Unless protected, not recommended for environments with harsh weather conditions or heavy rainfall. IP65 fittings recommended for such environments. To avoid disappointment and warranty problems, please ensure the IP Rating of the chosen product is relevant for the intended use.

Ulan Exterior Lighting



ULAN1
(Dark Grey)



ULAN2
(White)

- Exterior LED wall/ceiling lights
- Input voltage range: 220-240V AC 50/60Hz
- Output voltage range: 225-245V
- **Onboard inbuilt driver**
- Housing: powder coated aluminium
- Diffuser & bracket: PC
- LED chip: 25pcs 2835
- Power factor: >0.9
- Ambient temperature: -20 to 50°C
- Suitable for 2-way switching
- Suitable for use with PIR or Microwave sensors

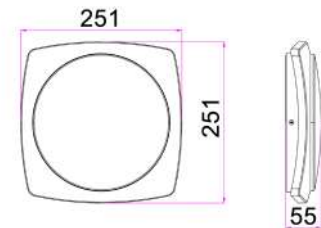

Part No.	ULAN1, ULAN2
Description	WALL / CEILING LED S/M Squirrel IP65 + Flush Base
Material	Powder coated aluminium & PC
Kelvin	3000K
Lumens	980LM
Wattage	20W
LED Chips	25pcs 2835
Power factor	>0.9
CRI	80
Dimensions	251 x 251 x 55mm
Carton QTY	1/4

*To avoid disappointment and warranty problems, please ensure the IP Rating of the chosen product is relevant for the intended use.

DOCCIA Exterior Lighting



DOCCIA1
(Dark Grey)



DOCCIA2
(White)

- Exterior LED wall/ceiling lights
- Input voltage range: 220-240V AC 50/60Hz
- Output voltage range: 225-245V AC
- **Onboard inbuilt driver included**
- Housing: powder coated aluminium
- Diffuser & bracket: PC
- LED chip: 28pcs 2835
- Power factor: >0.9
- Ambient temperature: -20 to 50°C
- Suitable for 2-way switching
- Suitable for use with PIR or Microwave sensors

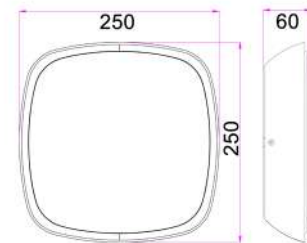

Part No.	DOCCIA1, DOCCIA2
Description	WALL / CEILING LED S/M Squirrel IP65 + Flush Base
Material	Powder coated aluminium & PC
Kelvin	3000K
Lumens	920LM
Wattage	20W
LED Chips	28pcs 2835
Power factor	>0.9
CRI	80
Dimensions	L 250 x W 250 x D 60mm
Carton QTY	1/4



*To avoid disappointment and warranty problems, please ensure the IP Rating of the chosen product is relevant for the intended use.

Step Lights Exterior Lighting



STE3-4
(Black Aluminium)

- Exterior LED surface mounted eyelid step lights
- Input voltage range: 12-14V DC / 220-240V AC
- Housing: Die cast aluminium
- Polished finish
- LED chips: 18pcs 2835
- Remote control gear required for 12V models (DC drivers only)

16,000hr Lifetime	120° Beam Angle	IP44 Rated	2YEAR Replacement Warranty
----------------------	--------------------	----------------------	---

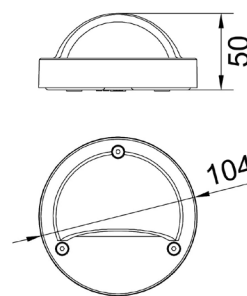

Tested & Recommended Drivers (for STE3):

CLADR12W / DRIV1 / OTTER1 / CLA111011 / CLA113011 /
CLA115011 / CLA1110011 / CLA1120011 / OTTER5

Part No.	Description	Kelvin	Lumens	Watt	CRI	Power Factor	Dimensions	Back Plate	Carton QTY
STE3	STEP EYELID LED 12V DC S/M BLK RND	3000K	144LM	1W	>70	1.0	Ø104x50mm	Ø104mm	1/50
STE4	STEP EYELID LED 240V S/M BLK RND	3000K	144LM	1W	>70	>0.3	Ø104x50mm	Ø104mm	1/50

**Unless protected, not recommended for environments with harsh weather conditions or heavy rainfall. IP65 fittings recommended for such environments. To avoid disappointment and warranty problems, please ensure the IP Rating of the chosen product is relevant for the intended use.*

Step Lights Exterior Lighting



STE6
(Matte Black)

STE5
(Matte White)

- Exterior LED recessed step lights
- Input voltage range: 100-240V AC 50/60Hz
- Housing: aluminium
- Diffuser: PC
- Bracket: aluminium
- LED chips: 6pcs 3030
- Power factor: >0.5
- Ambient temperature: -20 to 50°C
- Not suitable for dimming
- Suitable for 2 way switching
- Suitable for use with PIR or Microwave sensors

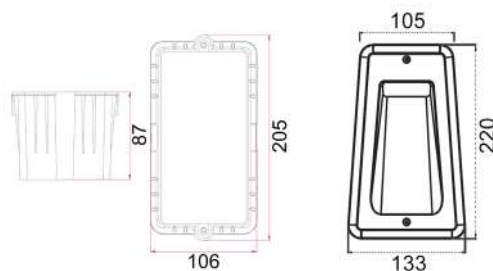

30,000hr Lifetime	120° Beam Angle	IP54 Rated	3YEAR Replacement Warranty
----------------------	--------------------	----------------------	---

Part No.	Description	Kelvin	Lumens	Watt	CRI	Dimensions	Cut Out	Carton QTY
STE5	WALL LED RECD MATTE WH Alum Trapezium	3000K	190LM	7W	>80	133x220mm	205x106mm	1/10
STE6	WALL LED RECD MATTE BLK Alum Trapezium	3000K	190LM	7W	>80	133x220mm	205x106mm	1/10

**Unless protected, not recommended for environments with harsh weather conditions or heavy rainfall. IP65 fittings recommended for such environments. To avoid disappointment and warranty problems, please ensure the IP Rating of the chosen product is relevant for the intended use.*

Step Lights Exterior Lighting

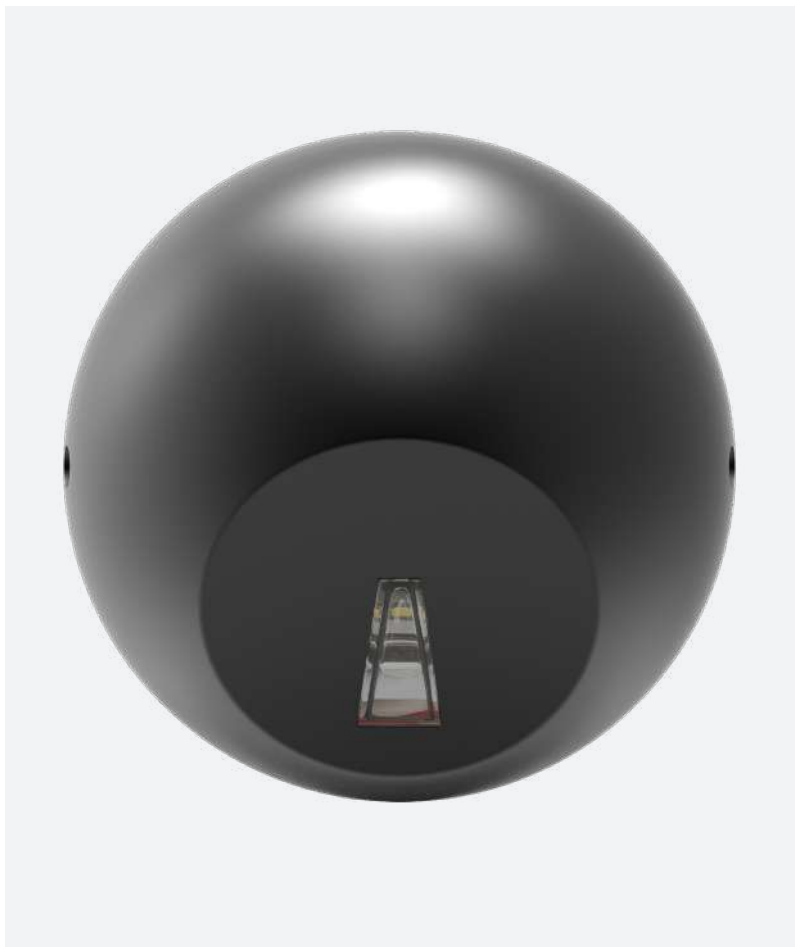

STE7
(Dark Grey)



STE8
(White)

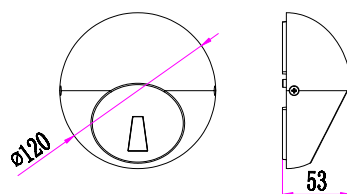

- Exterior LED surface mounted step lights
- Input voltage range: 100-240V AC 50/60Hz
- Housing: aluminium
- Bracket: aluminium
- LED chips: 1pc XPE
- Power factor: >0.5
- Ambient temperature: -20 to 50°C
- Not suitable for dimming
- Suitable for 2 way switching
- Suitable for use with PIR or Microwave sensors



Part No.	Description	Kelvin	Lumens	Watt	CRI	Dimensions	Cut Out	Carton QTY
STE7	STEP LED 240V AC S/M Dark Grey RND	3000K	45LM	3.5W	>80	Ø120x53mm	205x106mm	1/16
STE8	STEP LED 240V AC S/M WH RND	3000K	45LM	3.5W	>80	Ø120x53mm	205x106mm	1/16

*To avoid disappointment and warranty problems, please ensure the IP Rating of the chosen product is relevant for the intended use.

Step Lights Exterior Lighting



STE9
(Bronze)



STE10
(Brass Nickel Plated)

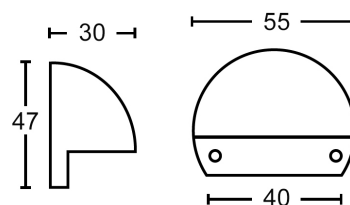

- Exterior LED surface mounted eyelid step lights
- Input voltage range: 12-14V AC/DC
- External 12V AC/DC Constant Voltage Control Gear required
- Recommended CLA drivers: OTTER1 series
- Material: solid bronze or solid brass
- Colours: aged bronze or nickel plated
- LED chip: 1pc XP-E-Q5
- Power factor: ≥ 0.95
- Ambient temperature: -40 to 85°C
- Not suitable for dimming



Part No.	Description	Kelvin	Lumens	Watt	CRI	Dimensions	Carton QTY
STE9	STEP EYELID LED 12V AC/DC S/M BRONZE Aged RND	3000K	107LM	1W	80	55x30mm	1/50
STE10	STEP EYELID LED 12V AC/DC S/M Brass Nickel Plated RND	3000K	107LM	1W	80	55x30mm	1/50

**To avoid disappointment and warranty problems, please ensure the IP Rating of the chosen product is relevant for the intended use.*

Step Lights Exterior Lighting



STE12
(Aged Bronze)

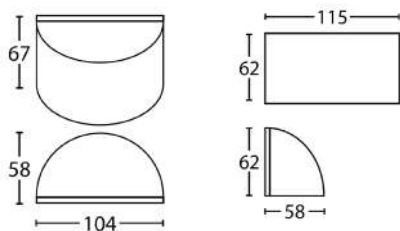

STE23
(Antique Bronze)



- Exterior surface mounted curved step lights
- Input voltage range: 12-14V AC/DC
- External 12V AC/DC Constant Voltage Control Gear required
- CLA recommended drivers: OTTER and CLA11 series
- Material: solid bronze
- Lamp holder: G4 (Max.20W)
- Globe not included
- Recommended CLA LED globes: G401, G403, CLAL1.58 Series, CLAG4L3CW/WW & CLAG4L15CW

G4

IP54
 Rated

2YEAR
 Replacement
Warranty

Part No.	Description	Lamp Holder	Max. Wattage	Dimensions	Carton QTY
STE23	WALL 12V AC/DC S/M Antique Bronze Curved G4 Bi-Pin	G4	20W	58x104x67mm	1/10
STE12	WALL 12V AC/DC S/M Bronze Lge Curved G4 Bi-Pin	G4	20W	115x62x58mm	1/10

**Unless protected, not recommended for environments with harsh weather conditions or heavy rainfall. IP65 fittings recommended for such environments. To avoid disappointment and warranty problems, please ensure the IP Rating of the chosen product is relevant for the intended use.*

Step Lights Exterior Lighting



STE13
(Anodized 316 Stainless Steel)

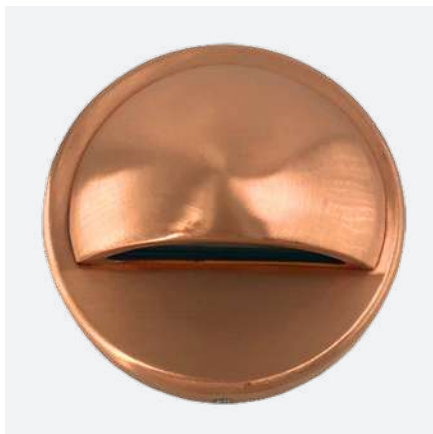

STE14
(Polished Solid Copper)

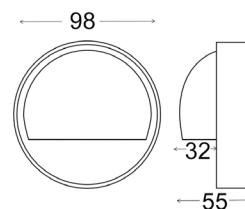

- Exterior LED surface mounted eyelid step lights
- Input voltage range: 12-14V AC/DC
- External 12V Constant Voltage control gear required
- Material: Anodized 316 stainless steel or polished solid copper
- LED chips: 3pcs XB-D
- Power factor: 0.95
- Ambient temperature: -40 to 85°C



Tested & Recommended Drivers:

CLADR12W / DRIV1 / OTTER1 / CLA111011 /
CLA113011 / CLA115011 / CLA1110011 /
CLA1115011 / CLA1120011



Part No.	Description	Kelvin	Lumens	Watt	CRI	Power Factor	Dimensions	Carton QTY
STE13	WALL 12V Built in LED S/M SS316 Lge Curved	3000K	240LM	3W	80	0.95	Ø98x55mm	1/25
STE14	WALL 12V Built in LED S/M Solid Copper Lge Curved	3000K	240LM	3W	80	0.95	Ø98x55mm	1/25

**Unless protected, not recommended for environments with harsh weather conditions or heavy rainfall. IP65 fittings recommended for such environments. To avoid disappointment and warranty problems, please ensure the IP Rating of the chosen product is relevant for the intended use.*

Step Lights Exterior Lighting



STE15 & STE17
(Matte Black Aluminium)



STE16 & STE18
(Titanium Aluminium)



- Exterior LED surface mounted eyelid step lights
- Input voltage range: 12-14V DC or 220-240V AC
- For 12-14V models: External 12V DC Constant Voltage control gear required
- Material: matt black or titanium aluminium
- Diffuser: PC
- LED chips: 12pcs 2835 LED
- Power factor: 0.98
- Ambient temperature: -40 to 85°C

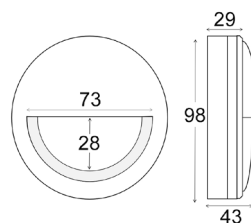

Tested & Recommended Drivers (for STE17&18):

DRIV1 / OTTER1 / CLA111011 / CLA113011 / CLA115011 / CLA1110011 / CLA1115011

Part No.	Description	Kelvin	Lumens	Watt	CRI	Power Factor	Dimensions	Carton QTY
STE15	STEP EYELID LED 240V S/M BLK RND	3000K	480LM	6W	75	0.98	Ø98x43mm	1/50
STE16	STEP EYELID LED 240V S/M Titanium RND	3000K	480LM	6W	75	0.98	Ø98x43mm	1/50
STE17	STEP EYELID LED 12V DC S/M BLK RND	3000K	480LM	6W	75	0.98	Ø98x43mm	1/50
STE18	STEP EYELID LED 12V DC S/M Titanium RND	3000K	480LM	6W	75	0.98	Ø98x43mm	1/50

*To avoid disappointment and warranty problems, please ensure the IP Rating of the chosen product is relevant for the intended use.

Step Lights Exterior Lighting



STE19 & STE20
(Antique Brass)

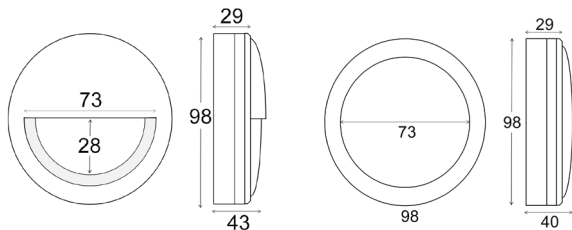

STE21 & STE22
(Antique Brass)



- Exterior LED surface mounted step lights
- Input voltage range: 12-14V DC / 220-240V AC
- External 12V DC Constant Voltage control gear required
- Material: solid brass
- Diffuser: PC
- LED chips: 12pcs 2835 LED
- Power factor: 0.98
- Ambient temperature: -40 to 85°C

40,000hr
Lifetime

120°
Beam Angle

IP65
Rated

2YEAR
Replacement
Warranty

Tested & Recommended Drivers (for STE20 & 22):

DRIV1 / OTTER1 / CLA111011 / CLA113011 / CLA115011 /
CLA1110011 / CLA1115011



Part No.	Description	Kelvin	Lumens	Watt	CRI	Power Factor	Dimensions	Carton QTY
STE19	STEP EYELID LED 240V S/M Antique Brass	3000K	480LM	6W	75	0.98	Ø98x43mm	1/20
STE20	STEP EYELID LED 12V DC S/M Antique Brass	3000K	480LM	6W	75	0.98	Ø98x43mm	1/20
STE21	STEP LED 240V S/M Antique Brass	3000K	600LM	6W	75	0.98	Ø98x43mm	1/20
STE22	STEP LED 12V DC S/M Antique Brass	3000K	600LM	6W	75	0.98	Ø98x43mm	1/20

*To avoid disappointment and warranty problems, please ensure the IP Rating of the chosen product is relevant for the intended use.

LED Pillar Lights Exterior Lighting



PDL1SQBL
(Black Aluminium)



PDL1SQBRZ
(Bronze)



PDL1SQSS
(316 Stainless Steel)

- Exterior LED pillar wall lights
- Input voltage: 12V DC
- External 12V DC Constant Voltage control gear required
- Housing: bronze/ aluminium/ Marine Grade 316 SS
- LED chips: 2835
- CRI: 75
- Ambient temperature: -40 to 85°C
- Not suitable for dimming

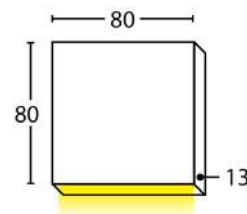

Part No.	PDL1SQBL, PDL1SQBRZ, PDL1SQSS
Description	WALL/ PILLAR LED S/M SQ 1 WAY
Material	PDL1SQBL: aluminium PDL1SQBRZ: bronze PDL1SQSS: 316 SS
Kelvin	3000K
Lumens	300LM
Wattage	3W
LED Chips	6pcs 2835
Power factor	0.98
CRI	75
Dimensions	L 80 x W 80 x D 13mm
Carton QTY	1/20

Tested & Recommended Drivers:
All CLA 12V DC Constant Voltage drivers

Part No.	Min.Load	Max.Load
DRIV1	1.2W	9.6W
OTTER1	1.2W	9.6W
CLA111011	1W	8W
CLA113011	3W	24W

**To avoid disappointment and warranty problems, please ensure the IP Rating of the chosen product is relevant for the intended use.*

LED Pillar Lights Exterior Lighting



PDLUDRECTBLK
(Black Aluminium)

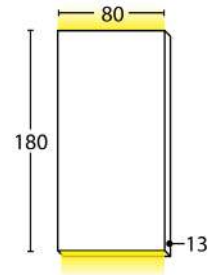

PDLUDRECTBRZ
(Bronze)



PDLUDRECTSS
(316 Stainless Steel)

- Exterior LED pillar wall lights
- Input voltage: 12V DC
- External 12V DC Constant Voltage control gear required
- Housing: bronze/ aluminium/ Marine Grade 316 SS
- LED chips: 2835
- CRI: 75
- Ambient temperature: -40 to 85°C
- Not suitable for dimming



Tested & Recommended Drivers:
All CLA 12V DC Constant Voltage drivers

Part No.	Min.Load	Max.Load
DRIV1	1.2W	9.6W
OTTER1	1.2W	9.6W
CLA111011	1W	8W
CLA113011	3W	24W

Part No.	PDLUDRECTBLK, PDLUDRECTBRZ, PDLUDRECTSS
Description	WALL/ PILLAR LED S/M RECT Up/ Down
Material	PDLUDRECTBLK: Aluminium PDLUDRECTBRZ: Bronze PDLUDRECTSS: 316 Stainless Steel
Kelvin	3000K
Lumens	2x300LM
Wattage	2x3W
LED Chips	2x6pcs 2835
Power factor	0.98
CRI	75
Dimensions	L 180 x W 80 x D 13mm
Carton QTY	1/20

**To avoid disappointment and warranty problems, please ensure the IP Rating of the chosen product is relevant for the intended use.*

Security Pillar Lights

Exterior Lighting

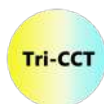

SEC05
(Single Head)



SEC08
(Double Heads)



SEC08S
(Double Heads with Sensor)

- LED Tri-CCT security pillar lights with/without sensor
- Input voltage: 240V AC 50/60Hz
- Inbuilt Constant Current LED driver
- Adjustable: 180° (90° up/down and left/right)
- Housing: powder coated aluminium
- Mounting bracket: aluminium
- Diffuser: clear glass with honeycomb louver
- Tri-CCT (3000K/ 4000K/ 5500K)
- CCT inbuilt switch under back plate
- LED chips: 1616 LEDs
- CRI: ≥80
- Power factor: ≥0.9
- Ambient temperature: -10 to 40°C
- Not suitable for dimming
- Suitable for 2 way switching

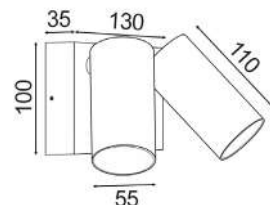
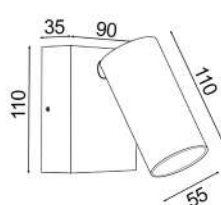

Sensor Technical Spec:

- Sensor type: PIR sensor
- Installation height: recommended 2-2.5m
- Detection angle: 120°
- Detection area: max.10m
- Detection range (ØxH): max.10m when installed 2-2.5m
- Time delay: 8 ± 5 sec to 12 ± 2 min (adjustable)
- Manual override: yes

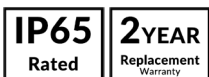

Part No.	Description	Lumens			Watt	Power Factor	CRI	Carton QTY
		3000K	4000K	5500K				
SEC05	Security S/ADJ LED WH No Sensor	760LM	800LM	850LM	8W	≥0.9	≥80	1/20
SEC08	D/ADJ LED Matte WH No Sensor	2x760LM	2x800LM	2x850LM	2x8W	≥0.9	≥80	1/10
SEC08S	D/ADJ LED Matte WH with Sensor	2x760LM	2x800LM	2x850LM	2x8W	≥0.9	≥80	1/10

*To avoid disappointment and warranty problems, please ensure the IP Rating of the chosen product is relevant for the intended use.

Security Pillar Lights Exterior Lighting



SEC06
(Single Head)



SEC09
(Double Heads)



SEC09S
(Double Heads with Sensor)

- LED Tri-CCT security pillar lights with/without sensor
- Input voltage: 240V AC 50/60Hz
- Inbuilt Constant Current LED driver
- Adjustable: 180° (90° up/down and left/right)
- Housing: powder coated aluminium
- Mounting bracket: aluminium
- Diffuser: clear glass with honeycomb louver
- Tri-CCT (3000K/ 4000K/ 5500K)
- CCT inbuilt switch under back plate
- LED chips: 1616 LEDs
- CRI: ≥80
- Power factor: ≥0.9
- Ambient temperature: -10 to 40°C
- Not suitable for dimming
- Suitable for 2 way switching

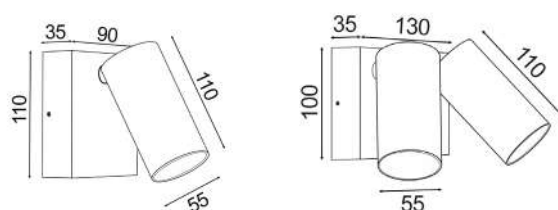
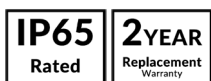

Sensor Technical Spec:

- Sensor type: PIR sensor
- Installation height: recommended 2-2.5m
- Detection angle: 120°
- Detection area: max.10m
- Detection range (ØxH): max.10m when installed 2-2.5m
- Time delay: 8 ± 5 sec to 12 ± 2 min (adjustable)
- Manual override: yes

Part No.	Description	Lumens			Watt	Power Factor	CRI	Carton QTY
		3000K	4000K	5500K				
SEC06	Security S/ADJ LED BLK No Sensor	760LM	800LM	850LM	8W	≥0.9	≥80	1/20
SEC09	D/ADJ LED Matte BLK No Sensor	2x760LM	2x800LM	2x850LM	2x8W	≥0.9	≥80	1/10
SEC09S	D/ADJ LED Matte BLK with Sensor	2x760LM	2x800LM	2x850LM	2x8W	≥0.9	≥80	1/10

*To avoid disappointment and warranty problems, please ensure the IP Rating of the chosen product is relevant for the intended use.

Security Pillar Lights Exterior Lighting



SEC07
(Single Head)



SEC10
(Double Heads)



SEC10S
(Double Heads with Sensor)

- LED Tri-CCT security pillar lights with/without sensor
- Input voltage: 240V AC 50/60Hz
- Inbuilt Constant Current LED driver
- Adjustable: 180° (90° up/down and left/right)
- Housing: anodized aluminium
- Mounting bracket: aluminium
- Diffuser: clear glass with honeycomb louver
- Tri-CCT (3000K/ 4000K/ 5500K)
- CCT inbuilt switch under back plate
- LED chips: 1616 LEDs
- CRI: ≥80
- Power factor: ≥0.9
- Ambient temperature: -10 to 40°C
- Not suitable for dimming
- Suitable for 2 way switching

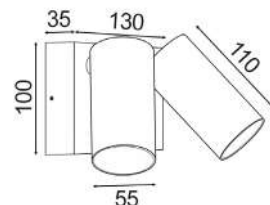
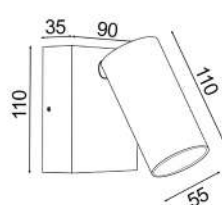

Sensor Technical Spec:

- Sensor type: PIR sensor
- Installation height: recommended 2-2.5m
- Detection angle: 120°
- Detection area: max.10m
- Detection range (ØxH): max.10m when installed 2-2.5m
- Time delay: 8 ± 5 sec to 12 ± 2 min (adjustable)
- Manual override: yes



Part No.	Description	Lumens			Watt	Power Factor	CRI	Carton QTY
		3000K	4000K	5500K				
SEC07	Security S/ADJ LED Titanium No Sensor	760LM	800LM	850LM	8W	≥0.9	≥80	1/20
SEC10	D/ADJ LED Titanium No Sensor	2x760LM	2x800LM	2x850LM	2x8W	≥0.9	≥80	1/10
SEC10S	D/ADJ LED Titanium with Sensor	2x760LM	2x800LM	2x850LM	2x8W	≥0.9	≥80	1/10

*To avoid disappointment and warranty problems, please ensure the IP Rating of the chosen product is relevant for the intended use.

Adjustable Pillar Spot Lights Exterior Lighting



SM1ACEC & SG1ACEC
(Copper)



SM1ACECA & SG1ACECA
(Aged Copper)

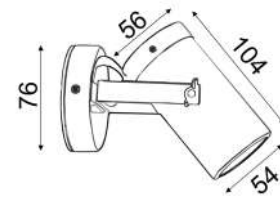

- Exterior single adjustable wall pillar/ spot lights
- Input voltage: 12V or 240V
- Material: solid copper (light weight)
- Anti-glare honey comb louver
- Lamp holder: GU10 or MR16
- Max 35W globe for GU10 models
- Max 20W globe for MR16 models
- Globes not included

 GU10	 MR16	IP54 Rated	2YEAR Replacement Warranty
--	--	----------------------	---

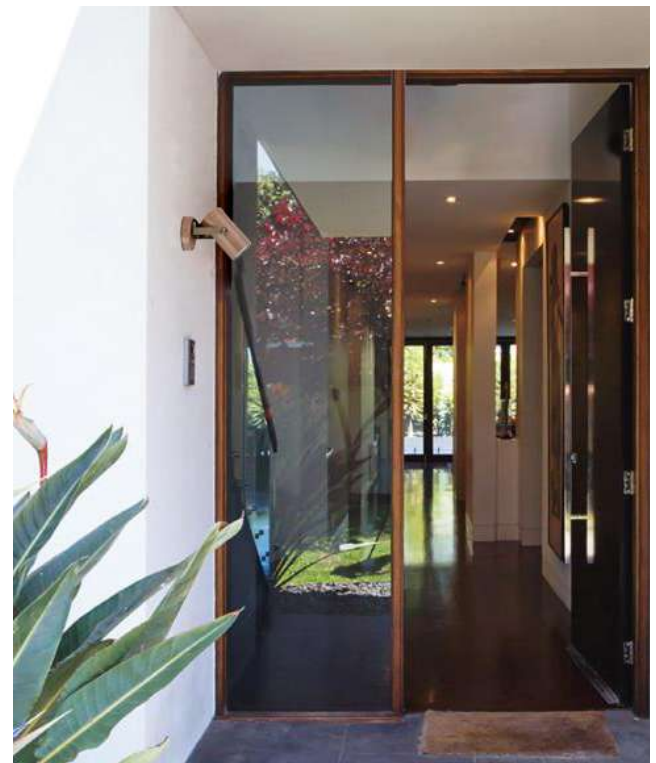

Part No.	Description	Lamp Holder	Max. Watt	Back Plate	Carton QTY
SG1ACEC	WALL GU10 PILLAR SPOT S/ADJ (Brass Bracket) COP	GU10	35W	Ø76mm	1/20
SG1ACECA	WALL GU10 PILLAR SPOT S/ADJ (Brass Bracket) AGED COP	GU10	35W	Ø76mm	1/20
SM1ACEC	WALL MR16 12V SPOT S/ADJ (Brass Bracket) COP	MR16	20W	Ø76mm	1/20
SM1ACECA	WALL MR16 PILLAR SPOT S/ADJ (Brass Bracket) AGED COP	MR16	20W	Ø76mm	1/20

*Unless protected, not recommended for environments with harsh weather conditions or heavy rainfall. IP65 fittings recommended for such environments. To avoid disappointment and warranty problems, please ensure the IP Rating of the chosen product is relevant for the intended use.

GU10 Pillar Lights (Copper) Exterior Lighting



PGUDC
(Up/Down)



PG1FC
(Single)



PG1AC
(Single Adjustable)



PG2AC
(Double Adjustable)

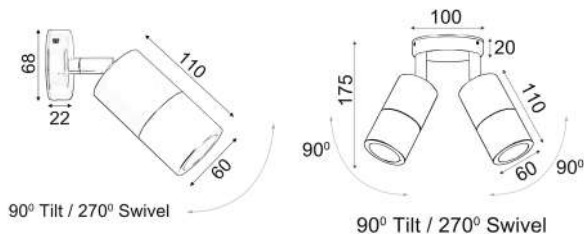
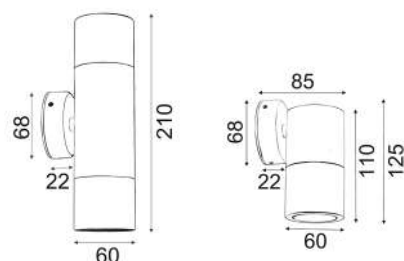
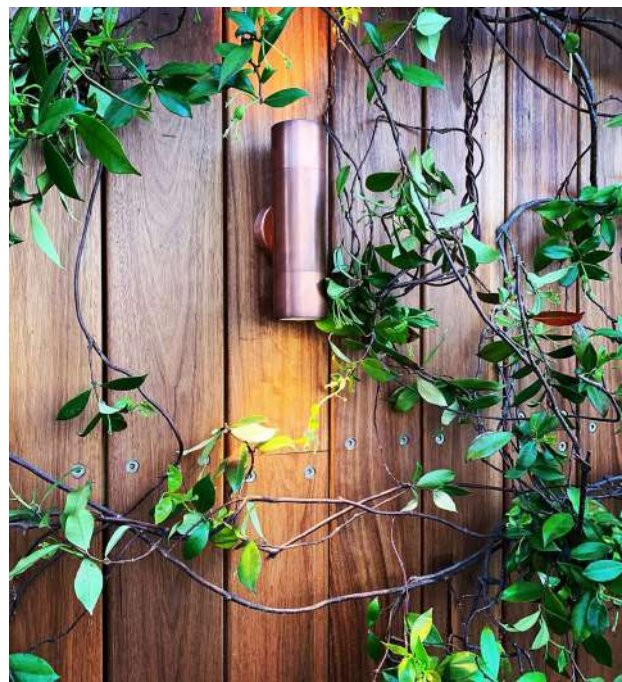

- Exterior surface mounted pillar lights
- Input voltage range: 110-265V AC 50/60Hz
- Material: copper
- Colour: copper
- Lamp holder: GU10 (Max.35W)
- Globes not included



Part No.	Description	Lamp Holder	Max. Watt	Back Plate	Carton QTY
PGUDC	WALL GU10 X 2 (Max 35W) PILLAR UP/DN COPPER	2xGU10	2x35W	Ø68x22mm	1/10
PG1FC	WALL GU10 (Max 35W) PILLAR FIXED COPPER	1xGU10	35W	Ø68x22mm	1/10
PG1AC	WALL GU10 (Max 35W) PILLAR S/ADJ COPPER	1xGU10	35W	Ø68x22mm	1/10
PG2AC	WALL GU10 X 2 (Max 35W) PILLAR D/ADJ RND BASE COPPER	2xGU10	2x35W	Ø100x20mm	1/10

*To avoid disappointment and warranty problems, please ensure the IP Rating of the chosen product is relevant for the intended use.

GU10 Pillar Lights (Light Weight Copper) Exterior Lighting



PGUDCEC
(Up/Down)



PG1FCEC
(Single)



PG1ACEC
(Single Adjustable)



PG2ACEC
(Double Adjustable)

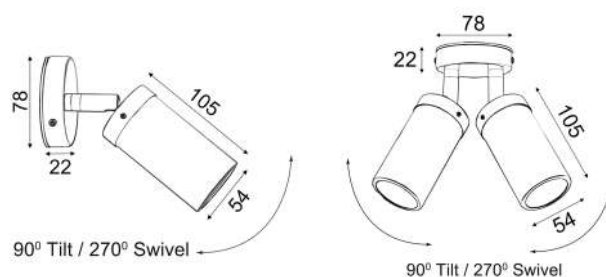
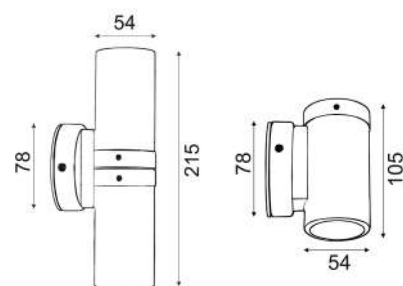

- Exterior surface mounted pillar lights
- Input voltage range: 110-265V AC 50/60Hz
- Material: copper (light weight)
- Colour: copper
- Anti-glare honey comb louver
- Lamp holder: GU10 (Max.35W)
- Globes not included

	IP54 Rated	2YEAR Replacement Warranty
--	----------------------	---

Part No.	Description	Lamp Holder	Max. Watt	Back Plate	Carton QTY
PGUDCEC	WALL GU10 X 2 (Max 35W) PILLAR UP/DN COPPER	2xGU10	2x35W	Ø78x22mm	1/20
PG1FCEC	WALL GU10 (Max 35W) PILLAR FIXED COPPER	1xGU10	35W	Ø78x22mm	1/20
PG1ACEC	WALL GU10 (Max 35W) PILLAR S/ADJ COPPER	1xGU10	35W	Ø78x22mm	1/20
PG2ACEC	WALL GU10 X 2 (Max 35W) PILLAR D/ADJ RND BASE COPPER	2xGU10	2x35W	Ø78x22mm	1/20

*Unless protected, not recommended for environments with harsh weather conditions or heavy rainfall. IP65 fittings recommended for such environments. To avoid disappointment and warranty problems, please ensure the IP Rating of the chosen product is relevant for the intended use.

GU10 Pillar Lights (Aged Copper) Exterior Lighting



PGUDCECA
(Up/Down)



PG1FCECA
(Single)



PG1ACECA
(Single Adjustable)



PG2ACECA
(Double Adjustable)

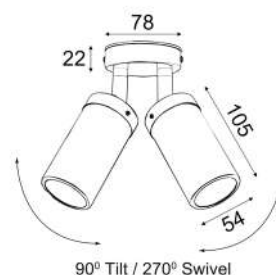
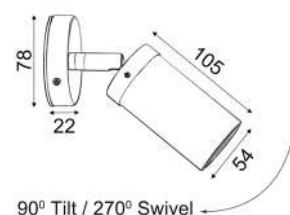
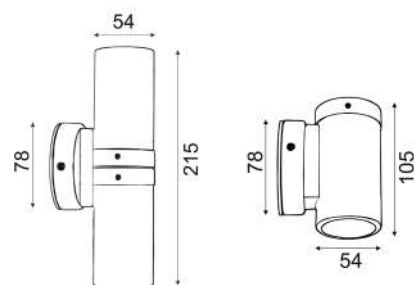

- Exterior surface mounted pillar lights
- Input voltage range: 110-265V AC 50/60Hz
- Material: copper (light weight)
- Colour: aged copper
- Anti-glare honey comb louver
- Lamp holder: GU10 (Max.35W)
- Globes not included



Part No.	Description	Lamp Holder	Max. Watt	Back Plate	Carton QTY
PGUDCECA	WALL GU10 X 2 (Max 35W) PILLAR UP/DN AGED COP	2xGU10	2x35W	Ø78x22mm	1/20
PG1FCECA	WALL GU10 (Max 35W) PILLAR FIXED AGED COP	1xGU10	35W	Ø78x22mm	1/20
PG1ACECA	WALL GU10 (Max 35W) PILLAR S/ADJ AGED COP	1xGU10	35W	Ø78x22mm	1/20
PG2ACECA	WALL GU10 X 2 (Max 35W) PILLAR D/ADJ RND BASE AGED COP	2xGU10	2x35W	Ø78x22mm	1/20

*Unless protected, not recommended for environments with harsh weather conditions or heavy rainfall. IP65 fittings recommended for such environments. To avoid disappointment and warranty problems, please ensure the IP Rating of the chosen product is relevant for the intended use.

GU10 Pillar Lights (Rustic Brass) Exterior Lighting



PGUDBR
(Up/Down)



PG1FBR
(Single)



PG1ABR
(Single Adjustable)



PG2ABR
(Double Adjustable)

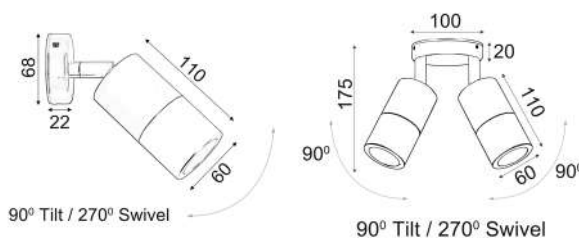
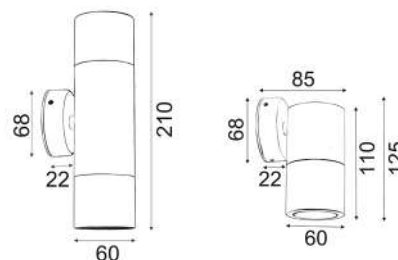

- Exterior surface mounted pillar lights
- Input voltage range: 110-265V AC 50/60Hz
- Material: solid brass
- Colour: rustic brass
- Lamp holder: GU10 (Max.35W)
- Globes not included



Part No.	Description	Lamp Holder	Max.Watt	Back Plate	Carton QTY
PGUDBR	WALL GU10 X 2 (Max 35W) PILLAR UP/DN Rustic Brass	2xGU10	2x35W	Ø68x22mm	1/10
PG1FBR	WALL GU10 (Max 35W) PILLAR FIXED Rustic Brass	1xGU10	35W	Ø68x22mm	1/10
PG1ABR	WALL GU10 (Max 35W) PILLAR S/ADJ Rustic Brass	1xGU10	35W	Ø68x22mm	1/10
PG2ABR	WALL GU10 X 2 (Max 35W) PILLAR D/ADJ RND BASE Rustic Brass	2xGU10	2x35W	Ø100x20mm	1/10

*To avoid disappointment and warranty problems, please ensure the IP Rating of the chosen product is relevant for the intended use.

GU10 Pillar Lights (Aged Brass) Exterior Lighting



PGUDBR1
(Up/Down)



PG1FBR1
(Single)

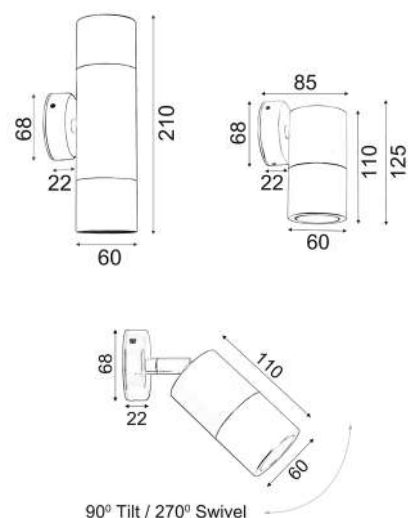

PG1ABR1
(Single Adjustable)



- Exterior surface mounted pillar lights
- Input voltage range: 110-265V AC 50/60Hz
- Material: solid brass
- Colour: aged brass
- Lamp holder: GU10 (Max.35W)
- Globes not included



Part No.	Description	Lamp Holder	Max.Watt	Back Plate	Carton QTY
PGUDBR1	WALL GU10 X 2 (Max 35W) PILLAR UP/DN Aged Brass	2xGU10	2x35W	Ø68x22mm	1/10
PG1FBR1	WALL GU10 (Max 35W) PILLAR FIXED Aged Brass	1xGU10	35W	Ø68x22mm	1/10
PG1ABR1	WALL GU10 (Max 35W) PILLAR S/ADJ Aged Brass	1xGU10	35W	Ø68x22mm	1/10

*To avoid disappointment and warranty problems, please ensure the IP Rating of the chosen product is relevant for the intended use.

GU10 Pillar Lights (Polished Brass) Exterior Lighting



PGUDBR2
(Up/Down)



PG1FBR2
(Single)



PG1ABR2
(Single Adjustable)



- Exterior surface mounted pillar lights
- Input voltage range: 110-265V AC 50/60Hz
- Material: solid brass
- Colour: polished brass
- Lamp holder: GU10 (Max.35W)
- Globes not included

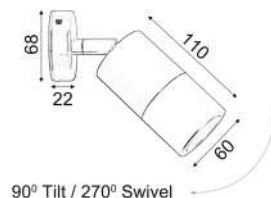
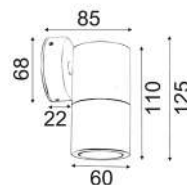
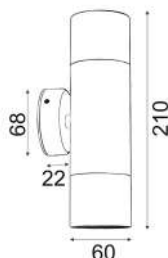

Part No.	Description	Lamp Holder	Max.Watt	Back Plate	Carton QTY
PGUDBR1	WALL GU10 X 2 (Max 35W) PILLAR UP/DN Aged Brass	2xGU10	2x35W	Ø68x22mm	1/10
PG1FBR1	WALL GU10 (Max 35W) PILLAR FIXED Aged Brass	1xGU10	35W	Ø68x22mm	1/10
PG1ABR1	WALL GU10 (Max 35W) PILLAR S/ADJ Aged Brass	1xGU10	35W	Ø68x22mm	1/10

*To avoid disappointment and warranty problems, please ensure the IP Rating of the chosen product is relevant for the intended use.

EXTERIOR LIGHTING

GU10 Pillar Lights (316 Stainless Steel) Exterior Lighting



PGUDSS
(Up/Down)



PG1FSS
(Single)



PG1ASS
(Single Adjustable)



PG2ASS
(Double Adjustable)

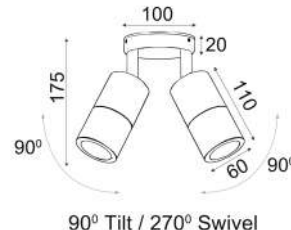
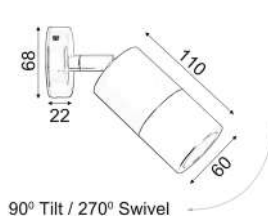
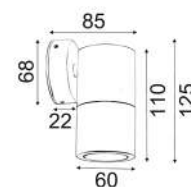
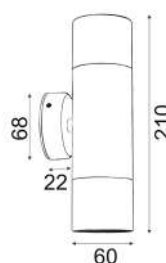

- Exterior surface mounted pillar lights
- Input voltage range: 110-265V AC 50/60Hz
- Material: 316 stainless steel
- Colour: stainless steel
- Lamp holder: GU10 (Max.35W)
- Globes not included

GU10	IP65 Rated	2YEAR Replacement Warranty
-------------	----------------------	---

Part No.	Description	Lamp Holder	Max.Watt	Back Plate	Carton QTY
PGUDSS	WALL GU10 X 2 (Max 35W) PILLAR UP/DN 316 SS	2xGU10	2x35W	Ø68x22mm	1/10
PG1FSS	WALL GU10 (Max 35W) PILLAR FIXED 316 SS	1xGU10	35W	Ø68x22mm	1/10
PG1ASS	WALL GU10 (Max 35W) PILLAR S/ADJ 316 SS	1xGU10	35W	Ø68x22mm	1/10
PG2ASS	WALL GU10 X 2 (Max 35W) PILLAR D/ADJ RND BASE 316 SS	2xGU10	2x35W	Ø100x20mm	1/10

*To avoid disappointment and warranty problems, please ensure the IP Rating of the chosen product is relevant for the intended use.

GU10 Pillar Lights (Anodized Aluminium) Exterior Lighting



PGUDSHSIL
(Up/Down)



PG1FHSIL
(Single)



PG1ASHSIL
(Single Adjustable)



PG2ASHSIL
(Double Adjustable)

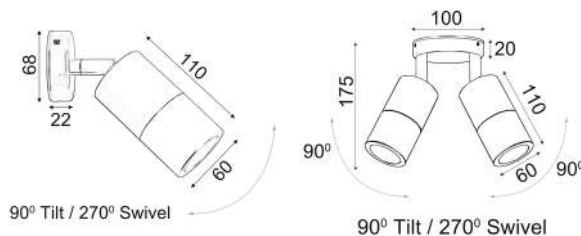
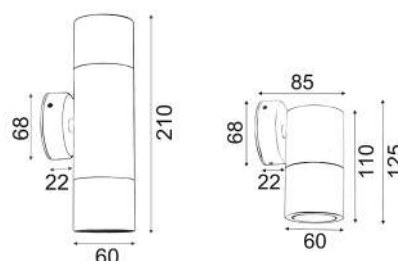

- Exterior surface mounted pillar lights
- Input voltage range: 110-265V AC 50/60Hz
- Material: Aluminium
- Colour: Anodized aluminium
- Lamp holder: GU10 (Max.35W)
- Globes not included



Part No.	Description	Lamp Holder	Max.Watt	Back Plate	Carton QTY
PGUDSHSIL	WALL GU10 X 2 (Max 35W) PILLAR UP/DN Anodized AL	2xGU10	2x35W	Ø68x22mm	1/10
PG1FHSIL	WALL GU10 (Max 35W) PILLAR FIXED Anodized AL	1xGU10	35W	Ø68x22mm	1/10
PG1ASHSIL	WALL GU10 (Max 35W) PILLAR S/ADJ Anodized AL	1xGU10	35W	Ø68x22mm	1/10
PG2ASHSIL	WALL GU10 X 2 (Max 35W) PILLAR D/ADJ RND BASE Anodized AL	2xGU10	2x35W	Ø100x20mm	1/10

*To avoid disappointment and warranty problems, please ensure the IP Rating of the chosen product is relevant for the intended use.

GU10 Pillar Lights (Black Aluminium) Exterior Lighting



PGUDBL
(Up/Down)



PG1FBL
(Single)



PG1ABL
(Single Adjustable)



PG2ABL
(Double Adjustable)

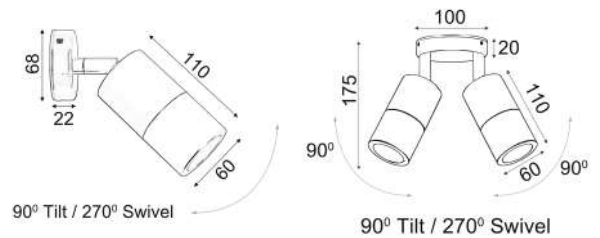
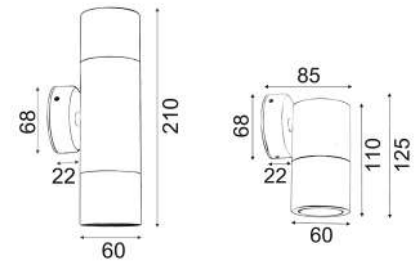

- Exterior surface mounted pillar lights
- Input voltage range: 110-265V AC 50/60Hz
- Material: aluminium
- Colour: powder coated black
- Lamp holder: GU10 (Max.35W)
- Globes not included

	IP65 Rated	2YEAR Replacement Warranty
--	----------------------	---

Part No.	Description	Lamp Holder	Max. Watt	Back Plate	Carton QTY
PGUDBL	WALL GU10 X 2 (Max 35W) PILLAR UP/DN BLK	2xGU10	2x35W	Ø68x22mm	1/20
PG1FBL	WALL GU10 (Max 35W) PILLAR FIXED BLK	1xGU10	35W	Ø68x22mm	1/20
PG1ABL	WALL GU10 (Max 35W) PILLAR S/ADJ BLK	1xGU10	35W	Ø68x22mm	1/25
PG2ABL	WALL GU10 X 2 (Max 35W) PILLAR D/ADJ RND BASE BLK	2xGU10	2x35W	Ø100x20mm	1/10

*To avoid disappointment and warranty problems, please ensure the IP Rating of the chosen product is relevant for the intended use.



PG2BARBL
(2 Heads)



PG4SQBL
(4 Heads)



PG3BARBL
(3 Heads)



PG4BARBL
(4 Heads)

- Exterior surface mounted pillar bar lights
- Input voltage range: 110-265V AC 50/60Hz
- Material: aluminium
- Colour: powder coated black
- Lamp holder: GU10 (Max.35W)
- Globes not included

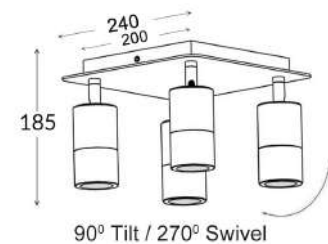
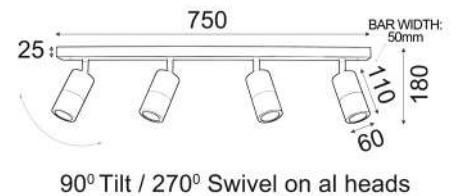
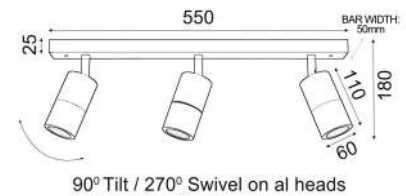
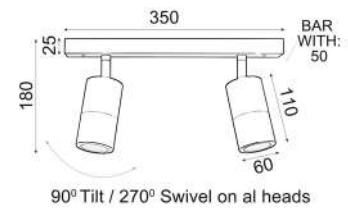

Part No.	Description	Lamp Holder	Max. Watt	Back Plate	Carton QTY
PG2BARBL	WALL GU10 X 2 (Max 35W) PILLAR D/ADJ BAR BLK	2xGU10	2x35W	350x50x25mm	1/10
PG3BARBL	WALL GU10 X 3 (Max 35W) PILLAR 3 Light BAR BLK	3xGU10	3x35W	550x50x25mm	1/10
PG4BARBL	WALL GU10 X 4 (Max 35W) PILLAR 4 Light BAR BLK	4xGU10	4x35W	750x50x25mm	1/10
PG4SQBL	WALL GU10 X 4 (Max 35W) PILLAR 4 Light BAR SQ BLK	4xGU10	4x35W	240x240mm	1/4

*Unless protected, not recommended for environments with harsh weather conditions or heavy rainfall. IP65 fittings recommended for such environments. To avoid disappointment and warranty problems, please ensure the IP Rating of the chosen product is relevant for the intended use.

GU10 Pillar Lights (White Aluminium) Exterior Lighting



PGUDWH
(Up/Down)



PG1FWH
(Single)



PG1AWH
(Single Adjustable)



PG2AWH
(Double Adjustable)

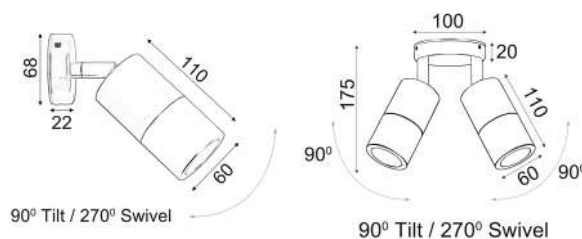
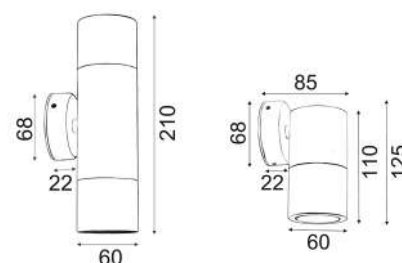

- Exterior surface mounted pillar lights
- Input voltage range: 110-265V AC 50/60Hz
- Material: aluminium
- Colour: powder coated white
- Lamp holder: GU10 (Max.35W)
- Globes not included



Part No.	Description	Lamp Holder	Max. Watt	Back Plate	Carton QTY
PGUDWH	WALL GU10 X 2 (Max 35W) PILLAR UP/DN WHITE	2xGU10	2x35W	Ø68x22mm	1/20
PG1FWH	WALL GU10 (Max 35W) PILLAR FIXED WHITE	1xGU10	35W	Ø68x22mm	1/20
PG1AWH	WALL GU10 (Max 35W) PILLAR S/ADJ WHITE	1xGU10	35W	Ø68x22mm	1/25
PG2AWH	WALL GU10 X 2 (Max 35W) PILLAR D/ADJ RND BASE WHITE	2xGU10	2x35W	Ø100x20mm	1/10

*To avoid disappointment and warranty problems, please ensure the IP Rating of the chosen product is relevant for the intended use.



PG2BARWH
(2 Heads)



PG4SQWH
(4 Heads)



PG3BARWH
(3 Heads)



PG4BARWH
(4 Heads)

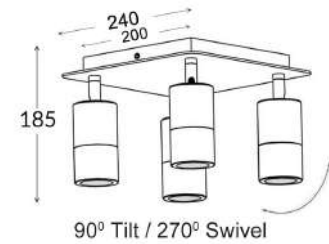
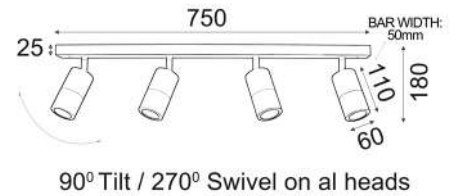
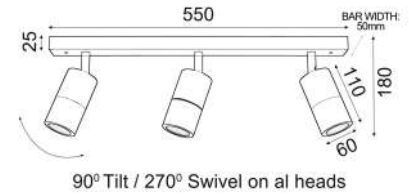
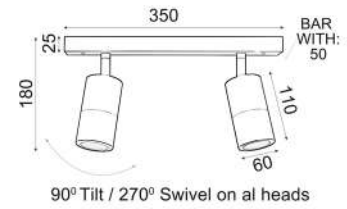

- Exterior surface mounted pillar bar lights
- Input voltage range: 110-265V AC 50/60Hz
- Material: aluminium
- Colour: powder coated white
- Lamp holder: GU10 (Max.35W)
- Globes not included



Part No.	Description	Lamp Holder	Max. Watt	Back Plate	Carton QTY
PG2BARWH	WALL GU10 X 2 (Max 35W) PILLAR D/ADJ BAR WHITE	2xGU10	2x35W	350x50x25mm	1/10
PG3BARWH	WALL GU10 X 3 (Max 35W) PILLAR 3 Light BAR WHITE	3xGU10	3x35W	550x50x25mm	1/10
PG4BARWH	WALL GU10 X 4 (Max 35W) PILLAR 4 Light BAR WHITE	4xGU10	4x35W	750x50x25mm	1/10
PG4SQWH	WALL GU10 X 4 (Max 35W) PILLAR 4 Light BAR SQ WHITE	4xGU10	4x35W	240x240mm	1/4

*Unless protected, not recommended for environments with harsh weather conditions or heavy rainfall. IP65 fittings recommended for such environments. To avoid disappointment and warranty problems, please ensure the IP Rating of the chosen product is relevant for the intended use.

GU10 Pillar Lights (Titanium Aluminium) Exterior Lighting



PGUDT
(Up/Down)



PG1FT
(Single)



PG1AT
(Single Adjustable)



PG2AT
(Double Adjustable)

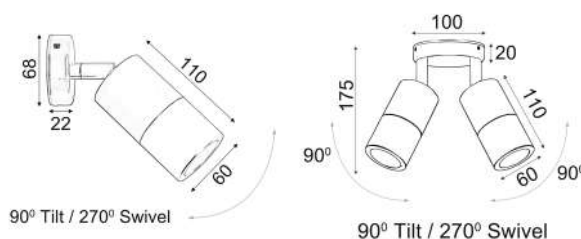
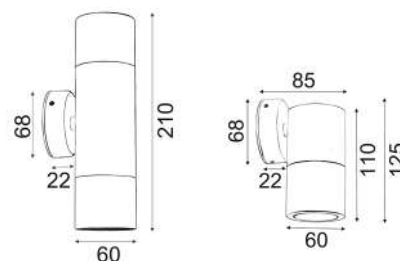

- Exterior surface mounted pillar lights
- Input voltage range: 110-265V AC 50/60Hz
- Material: anodized aluminium
- Colour: titanium
- Lamp holder: GU10 (Max.35W)
- Globes not included

	IP65 Rated	2YEAR Replacement Warranty
--	----------------------	---

Part No.	Description	Lamp Holder	Max. Watt	Back Plate	Carton QTY
PGUDT	WALL GU10 X 2 (Max 35W) PILLAR UP/DN TITANIUM	2xGU10	2x35W	Ø68x22mm	1/20
PG1FT	WALL GU10 (Max 35W) PILLAR FIXED TITANIUM	1xGU10	35W	Ø68x22mm	1/20
PG1AT	WALL GU10 (Max 35W) PILLAR S/ADJ TITANIUM	1xGU10	35W	Ø68x22mm	1/25
PG2AT	WALL GU10 X 2 (Max 35W) PILLAR D/ADJ RND BASE TITANIUM	2xGU10	2x35W	Ø100x20mm	1/10

*To avoid disappointment and warranty problems, please ensure the IP Rating of the chosen product is relevant for the intended use.



PG2BART
(2 Heads)



PG4SQT
(4 Heads)



PG3BART
(3 Heads)



PG4BART
(4 Heads)

- Exterior surface mounted pillar bar lights
- Input voltage range: 110-265V AC 50/60Hz
- Material: anodized aluminium
- Colour: titanium
- Lamp holder: GU10 (Max.35W)
- Globes not included

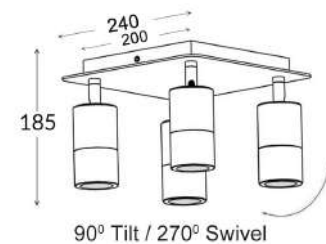
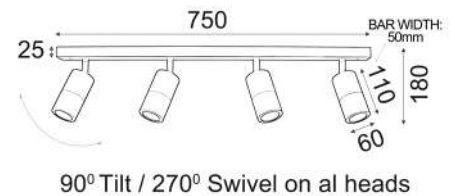
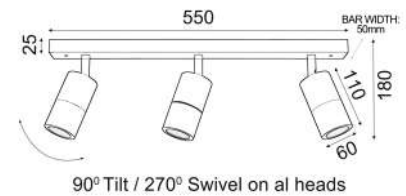
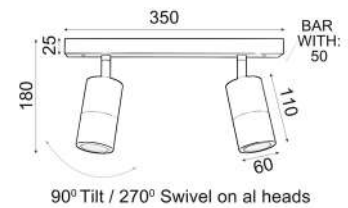

Part No.	Description	Lamp Holder	Max. Watt	Back Plate	Carton QTY
PG2BART	WALL GU10 X 2 (Max 35W) PILLAR D/ADJ BAR TITANIUM	2xGU10	2x35W	350x50x25mm	1/10
PG3BART	WALL GU10 X 3 (Max 35W) PILLAR 3 Light BAR TITANIUM	3xGU10	3x35W	550x50x25mm	1/10
PG4BART	WALL GU10 X 4 (Max 35W) PILLAR 4 Light BAR TITANIUM	4xGU10	4x35W	750x50x25mm	1/10
PG4SQT	WALL GU10 X 4 (Max 35W) PILLAR 4 Light BAR SQ TITANIUM	4xGU10	4x35W	240x240mm	1/4

*Unless protected, not recommended for environments with harsh weather conditions or heavy rainfall. IP65 fittings recommended for such environments. To avoid disappointment and warranty problems, please ensure the IP Rating of the chosen product is relevant for the intended use.

GU10 Pillar Lights (Matte Grey Aluminium) Exterior Lighting



PGUDSIL
(Up/Down)



PG1FSIL
(Single)



PG1ASIL
(Single Adjustable)



PG2ASIL
(Double Adjustable)

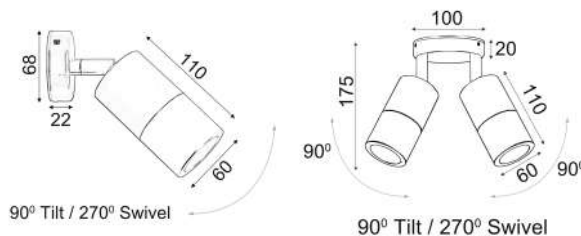
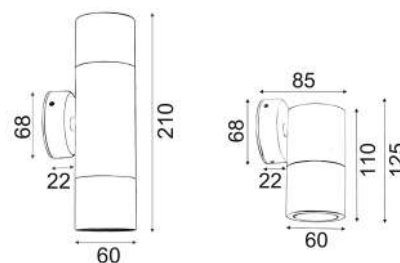

- Exterior surface mounted pillar lights
- Input voltage range: 110-265V AC 50/60Hz
- Material: aluminium
- Colour: powder coated matte grey
- Lamp holder: GU10 (Max.35W)
- Globes not included



Part No.	Description	Lamp Holder	Max. Watt	Back Plate	Carton QTY
PGUDSIL	WALL GU10 X 2 (Max 35W) PILLAR UP/DN MATTE GREY	2xGU10	2x35W	Ø68x22mm	1/20
PG1FSIL	WALL GU10 (Max 35W) PILLAR FIXED MATTE GREY	1xGU10	35W	Ø68x22mm	1/20
PG1ASIL	WALL GU10 (Max 35W) PILLAR S/ADJ MATTE GREY	1xGU10	35W	Ø68x22mm	1/25
PG2ASIL	WALL GU10 X 2 (Max 35W) PILLAR D/ADJ RND BASE MATTE GREY	2xGU10	2x35W	Ø100x20mm	1/10

*To avoid disappointment and warranty problems, please ensure the IP Rating of the chosen product is relevant for the intended use.

MR16 Pillar Lights (Light Weight Copper) Exterior Lighting



PMUDCEC
(Up/Down)

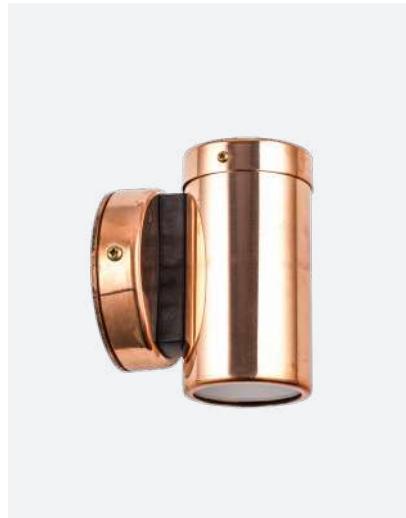

PM1FCEC
(Single)



PM1ACEC
(Single Adjustable)



PM2ACEC
(Double Adjustable)

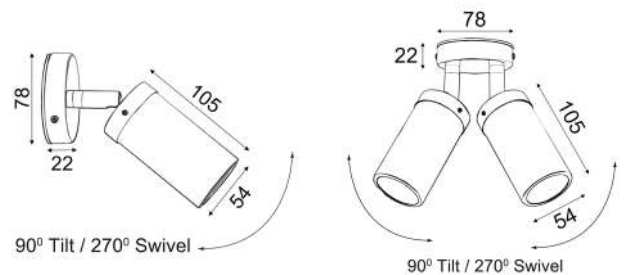
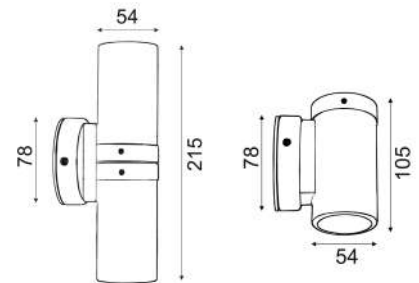

- Exterior surface mounted pillar lights
- Input voltage range: 12-24V AC/DC
- Material: copper (light weight)
- Colour: copper
- Anti-glare honey comb louver
- Lamp holder: MR16 (Max.20W)
- Globes not included
- Remote control gear required

	IP54 Rated	2YEAR Replacement Warranty
--	----------------------	---

Part No.	Description	Lamp Holder	Max. Watt	Back Plate	Carton QTY
PMUDCEC	WALL MR16 12V PILLAR UP/DN COP	2xMR16	2x20W	Ø78x22mm	1/20
PM1FCEC	WALL MR16 (Max 20W) 12V PILLAR FIXED COP	1xMR16	20W	Ø78x22mm	1/20
PM1ACEC	WALL MR16 12V PILLAR S/ADJ COP (Brass knuckle)	1xMR16	20W	Ø78x22mm	1/20
PM2ACEC	WALL MR16 12V PILLAR D/ADJ RND BASE COP	2xMR16	2x20W	Ø78x22mm	1/20

*Unless protected, not recommended for environments with harsh weather conditions or heavy rainfall. IP65 fittings recommended for such environments. To avoid disappointment and warranty problems, please ensure the IP Rating of the chosen product is relevant for the intended use.

MR16 Pillar Lights (Aged Copper) Exterior Lighting



PMUDCECA
(Up/Down)



PM1FCECA
(Single)



PM1ACECA
(Single Adjustable)



PM2ACECA
(Double Adjustable)

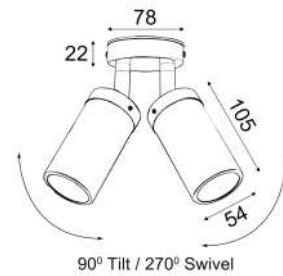
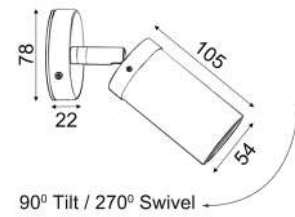
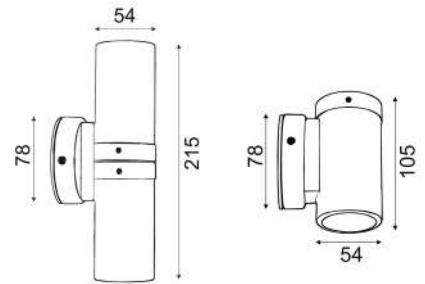

- Exterior surface mounted pillar lights
- Input voltage range: 12-24V AC/DC
- Material: copper (light weight)
- Colour: aged copper
- Anti-glare honey comb louver
- Lamp holder: MR16 (Max.20W)
- Globes not included
- Remote control gear required

MR16

IP54
 Rated

2YEAR
 Replacement
Warranty

Part No.	Description	Lamp Holder	Max. Watt	Back Plate	Carton QTY
PMUDCECA	WALL MR16 12V PILLAR UP/DN AGED COP	2xMR16	2x20W	Ø78x22mm	1/20
PM1FCECA	WALL MR16 (Max 20W) 12V PILLAR FIXED AGED COP	1xMR16	20W	Ø78x22mm	1/20
PM1ACECA	WALL MR16 12V PILLAR S/ADJ AGED COP (Brass knuckle)	1xMR16	20W	Ø78x22mm	1/20
PM2ACECA	WALL MR16 12V PILLAR D/ADJ RND BASE AGED COP	2xMR16	2x20W	Ø78x22mm	1/20

**Unless protected, not recommended for environments with harsh weather conditions or heavy rainfall. IP65 fittings recommended for such environments. To avoid disappointment and warranty problems, please ensure the IP Rating of the chosen product is relevant for the intended use.*

MR16 Pillar Lights (Rustic Brass) Exterior Lighting



PMUDBR
(Up/Down)



PM1FBR
(Single)



PM1ABR
(Single Adjustable)



PM2ABR
(Double Adjustable)

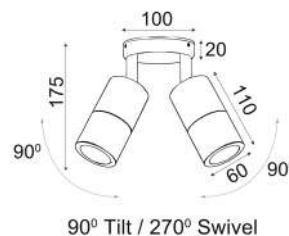
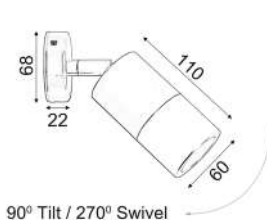
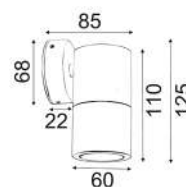
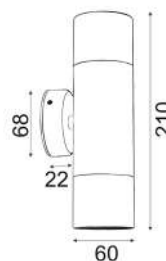

- Exterior surface mounted pillar lights
- Input voltage range: 12-24V AC/DC
- Material: solid brass
- Colour: rustic brass
- Lamp holder: MR16 (Max.20W)
- Globes not included
- Remote control gear required



Part No.	Description	Lamp Holder	Max. Watt	Back Plate	Carton QTY
PMUDBR	WALL MR16X2 (Max 20W) PILLAR UP/DN RUSTIC BRASS	2xMR16	2x20W	Ø68x22mm	1/10
PM1FBR	WALL MR16 (Max 20W) PILLAR FIXED RUSTIC BRASS	1xMR16	20W	Ø68x22mm	1/10
PM1ABR	WALL MR16 (Max 20W) PILLAR S/ADJ RUSTIC BRASS	1xMR16	20W	Ø68x22mm	1/10
PM2ABR	WALL MR16X2 (Max 20W) PILLAR D/ADJ RND BASE RUSTIC BRASS	2xMR16	2x20W	Ø100x20mm	1/10

*To avoid disappointment and warranty problems, please ensure the IP Rating of the chosen product is relevant for the intended use.

MR16 Pillar Lights (316 Stainless Steel) Exterior Lighting



PMUDSS
(Up/Down)



PM1FSS
(Single)



PM1ASS
(Single Adjustable)



PM2ASS
(Double Adjustable)

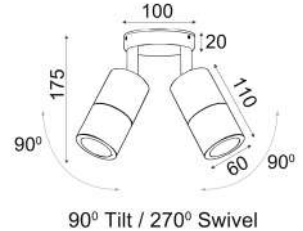
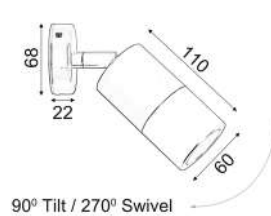
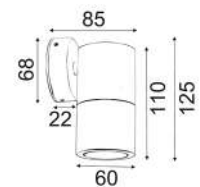
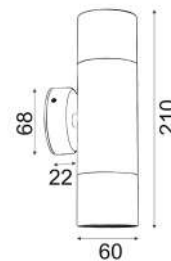

- Exterior surface mounted pillar lights
- Input voltage range: 12-24V AC/DC
- Material: 316 stainless steel
- Colour: stainless steel
- Lamp holder: MR16 (Max.20W)
- Globes not included
- Remote control gear required

MR16

IP65
 Rated

2YEAR
 Replacement
 Warranty

Part No.	Description	Lamp Holder	Max. Watt	Back Plate	Carton QTY
PMUDSS	WALL MR16 X 2 (Max 20W) PILLAR UP/DN 316 SS	2xMR16	2x20W	Ø68x22mm	1/10
PM1FSS	WALL MR16 (Max 20W) PILLAR FIXED 316 SS	1xMR16	20W	Ø68x22mm	1/25
PM1ASS	WALL MR16 (Max 20W) PILLAR S/ADJ 316 SS	1xMR16	20W	Ø68x22mm	1/25
PM2ASS	WALL MR16X2 (Max 20W) PILLAR D/ADJ RND BASE 316 SS	2xMR16	2x20W	Ø100x20mm	1/10

*To avoid disappointment and warranty problems, please ensure the IP Rating of the chosen product is relevant for the intended use.

MR16 Pillar Lights (Anodized Aluminium) Exterior Lighting



PMUDSHSIL
(Up/Down)



PM1FHSIL
(Single)



PM1ASHSIL
(Single Adjustable)



PM2ASHSIL
(Double Adjustable)

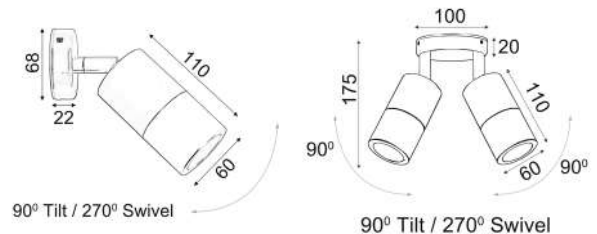
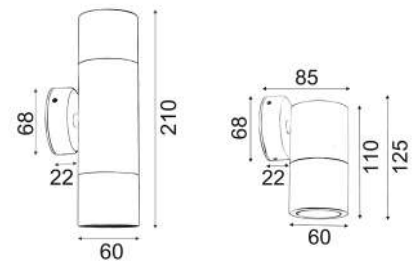

- Exterior surface mounted pillar lights
- Input voltage range: 12-24V AC/DC
- Material: aluminium
- Colour: anodized aluminium
- Lamp holder: MR16 (Max.20W)
- Globes not included
- Remote control gear required

MR16

IP65
Rated

2YEAR
Replacement
Warranty

Part No.	Description	Lamp Holder	Max. Watt	Back Plate	Carton QTY
PMUDSHSIL	WALL MR16 X 2 (Max 20W) PILLAR UP/DN ANODIZED AL	2xMR16	2x20W	Ø68x22mm	1/25
PM1FHSIL	WALL MR16 (Max 20W) PILLAR FIXED MATTE ANODIZED AL	1xMR16	20W	Ø68x22mm	1/25
PM1ASHSIL	WALL MR16 (Max 20W) PILLAR S/ADJ MATTE ANODIZED AL	1xMR16	20W	Ø68x22mm	1/25
PM2ASHSIL	WALL MR16X2 (Max 20W) PILLAR D/ADJ RND BASE ANODIZED AL	2xMR16	2x20W	Ø100x20mm	1/10

*To avoid disappointment and warranty problems, please ensure the IP Rating of the chosen product is relevant for the intended use.

MR16 Pillar Lights (Titanium Aluminium) Exterior Lighting



PMUDT
(Up/Down)



PM1FT
(Single)



PM1AT
(Single Adjustable)



PM2AT
(Double Adjustable)

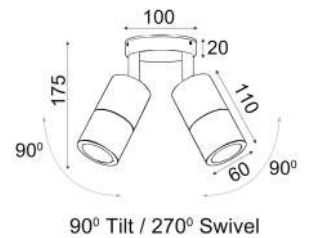
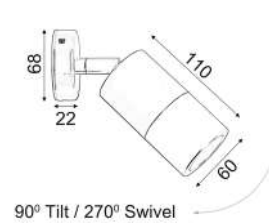
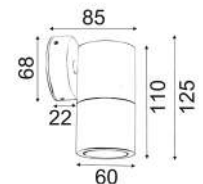
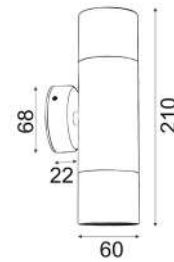

- Exterior surface mounted pillar lights
- Input voltage range: 12-24V AC/DC
- Material: anodized aluminium
- Colour: titanium
- Lamp holder: MR16 (Max.20W)
- Globes not included
- Remote control gear required

MR16

IP65

Rated

2YEAR

Replacement
Warranty

Part No.	Description	Lamp Holder	Max. Watt	Back Plate	Carton QTY
PMUDT	WALL MR16X2 (Max 20W) PILLAR UP/DN TITANIUM	2xMR16	2x20W	Ø68x22mm	1/25
PM1FT	WALL MR16 (Max 20W) PILLAR FIXED TITANIUM	1xMR16	20W	Ø68x22mm	1/25
PM1AT	WALL MR16 (Max 20W) PILLAR S/ADJ TITANIUM	1xMR16	20W	Ø68x22mm	1/25
PM2AT	WALL MR16X2 (Max 20W) PILLAR D/ADJ RND BASE TITANIUM	2xMR16	2x20W	Ø100x20mm	1/10

**To avoid disappointment and warranty problems, please ensure the IP Rating of the chosen product is relevant for the intended use.*

MR16 Pillar Lights (Black Aluminium) Exterior Lighting



PMUDBL
(Up/Down)



PM1FBL
(Single)



PM1ABL
(Single Adjustable)



PM2ABL
(Double Adjustable)

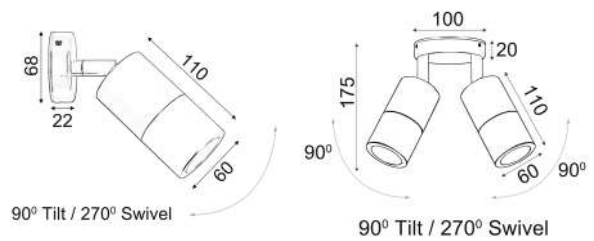
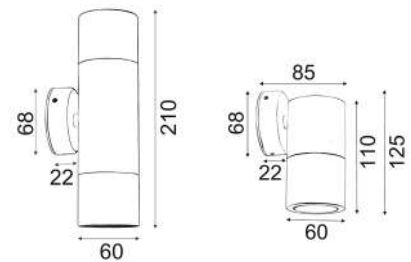

- Exterior surface mounted pillar lights
- Input voltage range: 12-24V AC/DC
- Material: aluminium
- Colour: powder coated black
- Lamp holder: MR16 (Max.20W)
- Globes not included
- Remote control gear required

MR16

IP65
Rated

2YEAR
Replacement
Warranty

Part No.	Description	Lamp Holder	Max. Watt	Back Plate	Carton QTY
PMUDBL	WALL MR16 X 2 (Max 20W) PILLAR UP/DN BLK	2xMR16	2x20W	Ø68x22mm	1/25
PM1FBL	WALL MR16 (Max 20W) PILLAR FIXED BLK	1xMR16	20W	Ø68x22mm	1/25
PM1ABL	WALL MR16 (Max 20W) PILLAR S/ADJ BLK	1xMR16	20W	Ø68x22mm	1/25
PM2ABL	WALL MR16 X 2 (Max 20W) PILLAR D/ADJ RND BASE BLK	2xMR16	2x20W	Ø100x20mm	1/10

*To avoid disappointment and warranty problems, please ensure the IP Rating of the chosen product is relevant for the intended use.

MR16 Pillar Lights (White Aluminium) Exterior Lighting



PMUDWH
(Up/Down)



PM1FWH
(Single)



PM1AWH
(Single Adjustable)



PM2AWH
(Double Adjustable)

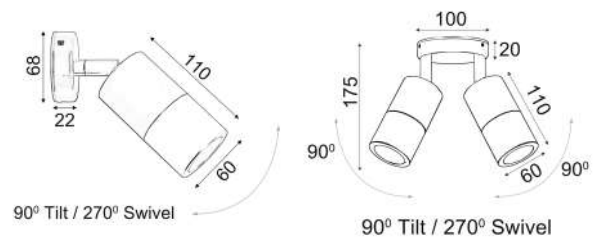
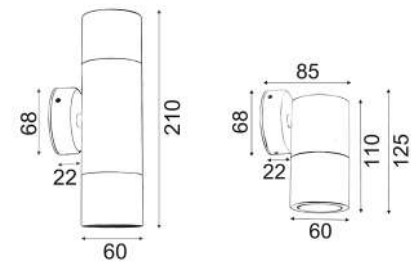

- Exterior surface mounted pillar lights
- Input voltage range: 12-24V AC/DC
- Material: aluminium
- Colour: white
- Lamp holder: MR16 (Max.20W)
- Globes not included
- Remote control gear required



Part No.	Description	Lamp Holder	Max. Watt	Back Plate	Carton QTY
PMUDWH	WALL MR16 X 2 (Max 20W) PILLAR UP/DN WHITE	2xMR16	2x20W	Ø68x22mm	1/25
PM1FWH	WALL MR16 (Max 20W) PILLAR FIXED WHITE	1xMR16	20W	Ø68x22mm	1/25
PM1AWH	WALL MR16 (Max 20W) PILLAR S/ADJ WHITE	1xMR16	20W	Ø68x22mm	1/25
PM2AWH	WALL MR16X2 (Max 20W) PILLAR D/ADJ RND BASE WHITE	2xMR16	2x20W	Ø100x20mm	1/10

*To avoid disappointment and warranty problems, please ensure the IP Rating of the chosen product is relevant for the intended use.

MR16 Pillar Lights (Matte Grey Aluminium) Exterior Lighting



PMUDSIL
(Up/Down)



PM1FSIL
(Single)



PM1ASIL
(Single Adjustable)



PM2ASIL
(Double Adjustable)

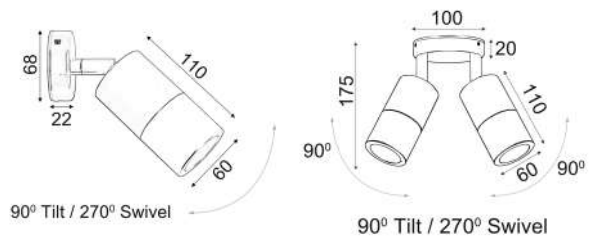
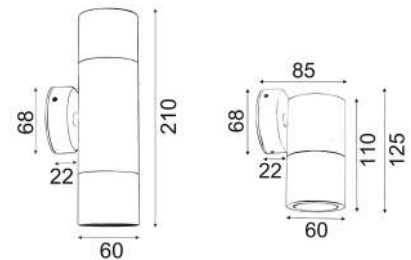

- Exterior surface mounted pillar lights
- Input voltage range: 12-24V AC/DC
- Material: aluminium
- Colour: matte grey
- Lamp holder: MR16 (Max.20W)
- Globes not included
- Remote control gear required

MR16

IP65
 Rated

2YEAR
 Replacement
 Warranty

Part No.	Description	Lamp Holder	Max. Watt	Back Plate	Carton QTY
PMUDSIL	WALL MR16 X 2 (Max 20W) PILLAR UP/DN MATTE GREY	2xMR16	2x20W	Ø68x22mm	1/25
PM1FSIL	WALL MR16 (Max 20W) PILLAR FIXED MATTE GREY	1xMR16	20W	Ø68x22mm	1/25
PM1ASIL	WALL MR16 (Max 20W) PILLAR S/ADJ MATTE GREY	1xMR16	20W	Ø68x22mm	1/25
PM2ASIL	WALL MR16 X 2 (Max 20W) PILLAR D/ADJ RND BASE MATTE GREY	2xMR16	2x20W	Ø100x20mm	1/10

*To avoid disappointment and warranty problems, please ensure the IP Rating of the chosen product is relevant for the intended use.

Borda Exterior Lighting



BORDA1
(Black / Wall Light)



BORDA2
(Stainless Steel / Wall Light)

- Exterior surface mounted wall & bollard lights
- Input voltage range: 220-240V AC 50/60Hz
- Housing: 304 stainless steel
- Diffuser: opal PC (Ø115 x H 160mm)
- Lamp holder: E27 (Max.18W)
- Globe not included
- Recommended CLA globes: 3U001-003 (when used with external control gear), CAN & LT series
- For bollard lights, to maintain the IP rating please use circular cable in junction
- For bollard lights, for parallel and single connection we recommend using an appropriate IP68 connector

***These bollards are designed for mounting on a solid surface such as a concrete path or sturdy timber decking**



BORDA3
(Black / Bollard Light / Short)



BORDA6
(Stainless Steel / Bollard Light/ Long)

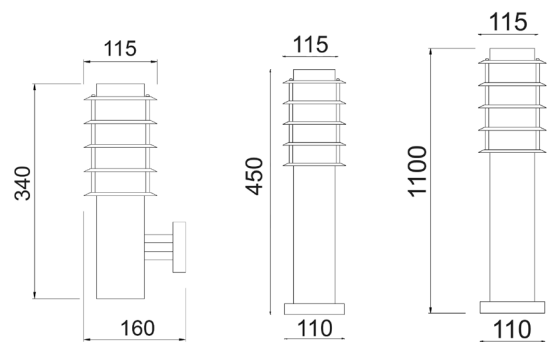

Part No.	Description	Diam	Inside Louvr	Height	Base	Carton QTY
BORDA1	WALL ES S/M FIXED SS304 BLACK	Ø115mm	Ø76x160mm	340mm	Ø110mm	1/10
BORDA2	WALL ES S/M FIXED SS304	Ø115mm	Ø76x160mm	340mm	Ø110mm	1/10
BORDA3	BOLLARD SHORT SS304 ES BLACK H450MM	Ø115mm	Ø76x160mm	450mm	Ø110mm	1/10
BORDA4	BOLLARD SHORT SS304 ES H450MM	Ø115mm	Ø76x160mm	450mm	Ø110mm	1/10
BORDA5	BOLLARD LONG SS304 ES BLACK H1000MM	Ø115mm	Ø76x160mm	1100mm	Ø110mm	1/10
BORDA6	BOLLARD LONG SS304 ES H1000MM	Ø115mm	Ø76x160mm	1100mm	Ø110mm	1/10

**Unless protected, not recommended for environments with harsh weather conditions or heavy rainfall. IP65 fittings recommended for such environments. To avoid disappointment and warranty problems, please ensure the IP Rating of the chosen product is relevant for the intended use.*

Torre Exterior Lighting



TORRE1
(Black/ Wall Light)



TORRE2
(Stainless Steel/ Wall Light)

- Exterior surface mounted wall & bollard lights
- Input voltage range: 220-240V AC 50/60Hz
- Housing: 304 stainless steel
- Diffuser: opal PC (Ø76 x H 160mm)
- Lamp holder: E27 (Max.18W)
- Globe not included
- Recommended CLA globes: 3U001-003 (when used with external control gear), CAN & LT series
- For bollard lights, to maintain the IP rating please use circular cable in junction
- For bollard lights, for parallel and single connection we recommend using an appropriate IP68 connector

***These bollards are designed for mounting on a solid surface such as a concrete path or sturdy timber decking**

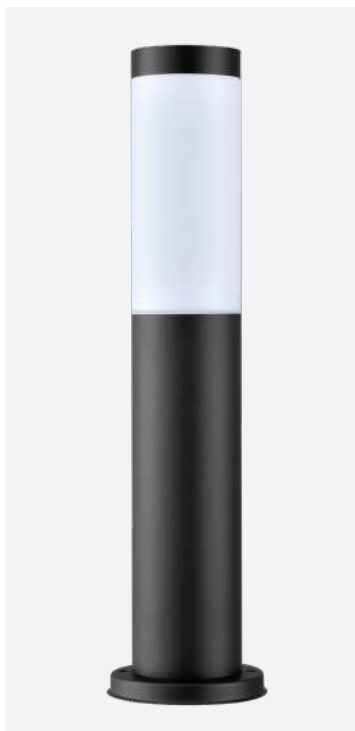

TORRE3
(Black/ Bollard Light/ Short)



TORRE4
(Stainless Steel/ Bollard Light/ Short)

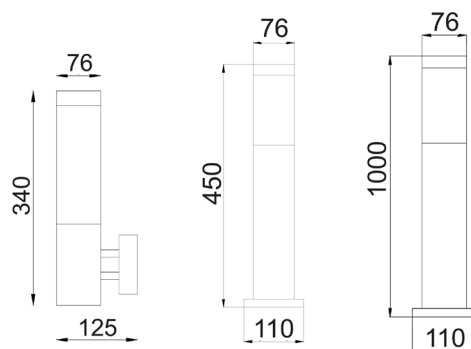

Part No.	Description	Diam	Height	Base	Carton QTY
TORRE1	WALL ES S/M FIXED SS304 BLACK RND	Ø76mm	340mm	Ø110mm	1/10
TORRE2	WALL ES S/M FIXED SS304 RND	Ø76mm	340mm	Ø110mm	1/10
TORRE3	BOLLARD SHORT SS304 ES BLK H450mm	Ø76mm	450mm	Ø110mm	1/10
TORRE4	BOLLARD SHORT SS304 ES H450mm	Ø76mm	450mm	Ø110mm	1/10
TORRE5	BOLLARD LONG SS304 BLACK ES H1000mm	Ø76mm	1000mm	Ø110mm	1/10
TORRE6	BOLLARD LONG SS304 ES H1000mm	Ø76mm	1000mm	Ø110mm	1/10

**Unless protected, not recommended for environments with harsh weather conditions or heavy rainfall. IP65 fittings recommended for such environments. To avoid disappointment and warranty problems, please ensure the IP Rating of the chosen product is relevant for the intended use.*

Phare (GU10) Exterior Lighting



PHARE01G
(Wall Light)

PHARE02G
(Wall Light)

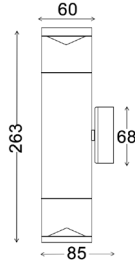

- Exterior surface mounted wall & bollard lights
- Input voltage range: 110-265V AC
- Housing: aluminium /acrylic/ 316 stainless steel
- Lamp holder: GU10 (Max.35W)
- Globe not included
- IP rating: wall lamps IP65 and bollard lights IP54
- For bollard lights, to maintain the IP rating please use circular cable in junction
- For bollard lights, for parallel and single connection we recommend using an appropriate IP68 connector

***These bollards are designed for mounting on a solid surface such as a concrete path or sturdy timber decking**

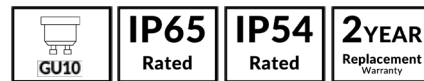

PHARE03G
(Bollard Light)



PHARE03EXT
(Bollard Extension)



PHARE04G
(Bollard Light)



PHARE04EXT
(Bollard Extension)



PHARE05G
(Bollard Light)

Part No.	Description	Lamp Holder	Max. Watt	Diam	Height	Mounting Plate	Carton QTY
PHARE01G	WALL PILLAR UP/DN MATTE BLK Anti Glare	2xGU10	35W	Ø60mm	263mm	Ø68mm	1/20
PHARE02G	WALL PILLAR UP/DN ALU TITANIUM Anodized	2xGU10	35W	Ø60mm	263mm	Ø68mm	1/20
PHARE03G	BOLLARD ALU MATTE BLK Anti Glare	1xGU10	35W	Ø60mm	445mm	Ø83mm	1/10
PHARE04G	BOLLARD ALU TITANIUM Anodized Anti Glare	1xGU10	35W	Ø60mm	445mm	Ø83mm	1/10
PHARE05G	BOLLARD SS316 35W Anti Glare	1xGU10	35W	Ø60mm	435mm	Ø83mm	1/10
BOLLARD EXTENSION							
PHARE03EXT	BOLLARD EXTENSION MATTE BLK Screw in	-	-	Ø60mm	380mm	-	1/25
PHARE04EXT	BOLLARD EXTENSION TITANIUM Screw in	-	-	Ø60mm	380mm	-	1/25

*For bollard Lights, Unless protected, not recommended for environments with harsh weather conditions or heavy rainfall. IP65 fittings recommended for such environments. To avoid disappointment and warranty problems, please ensure the IP Rating of the chosen product is relevant for the intended use.

Phare (MR16) Exterior Lighting



PHARE01M
(Wall Light)

PHARE02M
(Wall Light)

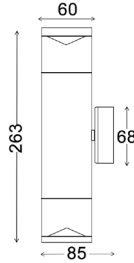

- Exterior surface mounted wall & bollard lights
- Input voltage range: 12-24V AC/DC
- Housing: aluminium /acrylic/ 316 stainless steel
- Lamp holder: MR16 (Max.20W)
- Globe not included
- IP rating: wall lamps IP65 and bollard lights IP54
- For bollard lights, to maintain the IP rating please use circular cable in junction
- For bollard lights, for parallel and single connection we recommend using an appropriate IP68 connector

***These bollards are designed for mounting on a solid surface such as a concrete path or sturdy timber decking**

MR16	IP65 Rated	IP54 Rated	2YEAR Replacement Warranty
------	----------------------	----------------------	---

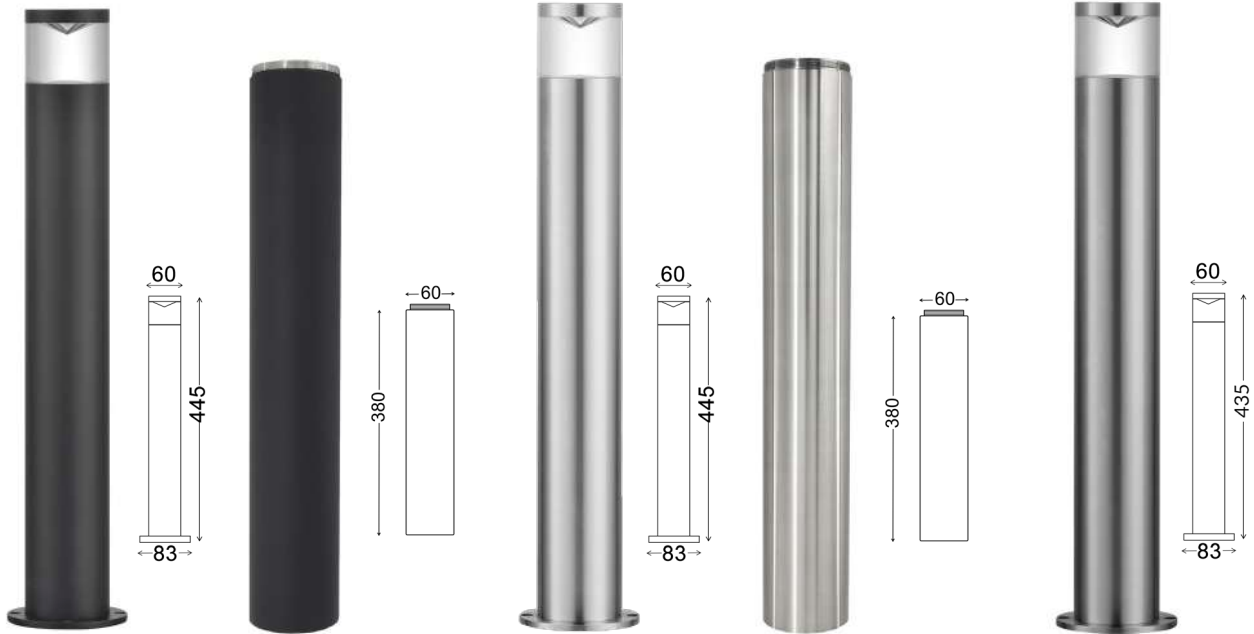

PHARE03M
(Bollard Light)

PHARE03EXT
(Bollard Extension)

PHARE04M
(Bollard Light)

PHARE04EXT
(Bollard Extension)

PHARE05M
(Bollard Light)

Part No.	Description	Lamp Holder	Max. Watt	Diam	Height	Mounting Plate	Carton QTY
PHARE01M	WALL PILLAR UP/DN MATTE BLK Anti Glare	2xMR16	20W	Ø60mm	263mm	Ø68mm	1/20
PHARE02M	WALL PILLAR UP/DN ALU TITANIUM Anodized	2xMR16	20W	Ø60mm	263mm	Ø68mm	1/20
PHARE03M	BOLLARD ALU MATTE BLK Anti Glare	1xMR16	20W	Ø60mm	445mm	Ø83mm	1/10
PHARE04M	BOLLARD ALU TITANIUM Anodized Anti Glare	1xMR16	20W	Ø60mm	445mm	Ø83mm	1/10
PHARE05M	BOLLARD SS316 35W Anti Glare	1xMR16	20W	Ø60mm	435mm	Ø83mm	1/10
BOLLARD EXTENSION							
PHARE03EXT	BOLLARD EXTENSION MATTE BLK Screw in	-	-	Ø60mm	380mm	-	1/25
PHARE04EXT	BOLLARD EXTENSION TITANIUM Screw in	-	-	Ø60mm	380mm	-	1/25

*For bollard Lights, Unless protected, not recommended for environments with harsh weather conditions or heavy rainfall. IP65 fittings recommended for such environments. To avoid disappointment and warranty problems, please ensure the IP Rating of the chosen product is relevant for the intended use.

Elanora Exterior Lighting

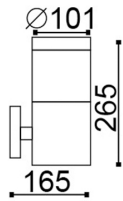

CLAW32
(Wall Light)

- Exterior surface mounted wall & bollard lights
- Input voltage range: 220-240V AC 50/60Hz
- Housing: powder coated 304 stainless steel
- Screws & surface mounting bracket + louvres: stainless steel (Not for use inground)
- Diffuser: clear PC
- Lamp holder: E27 (Max.18W)
- Recommended CLA globes: 3U001-003 (when used with external control gear), CAN & LT series (Limited space of Ø53mm x H 145mm available)
- Globe not included
- For bollard lights, to maintain the IP rating please use circular cable in junction
- For bollard lights, for parallel and single connection we recommend using an appropriate IP68 connector

***These bollards are designed for mounting on a solid surface such as a concrete path or sturdy timber decking**



CLA1615LBL
(Bollard Light)



CLA1615L
(Bollard Light)

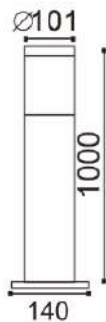

CLA1615SBL
(Bollard Light)



CLA1615S
(Bollard Light)

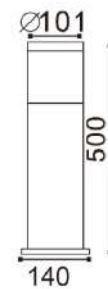

Part No.	Description	Lamp Holder	Diam	Inside Louvr	Height	Mounting Plate	Carton QTY
CLAW32	WALL ES S/M FIXED	E27	Ø101mm	Ø53 x H 145mm	265mm	Ø97mm	1/10
CLA1615SBL	BOLLARD SS304 ES BLK	E27	Ø101mm	Ø53 x H 145mm	500mm	Ø145mm	1/10
CLA1615S	BOLLARD SS304 ES	E27	Ø101mm	Ø53 x H 145mm	500mm	Ø145mm	1/10
CLA1615LBL	BOLLARD SS304 ES BLK LONG	E27	Ø101mm	Ø53 x H 145mm	1000mm	Ø145mm	1/4
CLA1615L	BOLLARD SS304 ES LONG	E27	Ø101mm	Ø53 x H 145mm	1000mm	Ø145mm	1/4

**Unless protected, not recommended for environments with harsh weather conditions or heavy rainfall. IP65 fittings recommended for such environments. To avoid disappointment and warranty problems, please ensure the IP Rating of the chosen product is relevant for the intended use.*

Portus Exterior Lighting



PORTUS1FLC
(Copper / Bollard Light)



PORTUS1FLSS
(SS316 / Bollard Light)

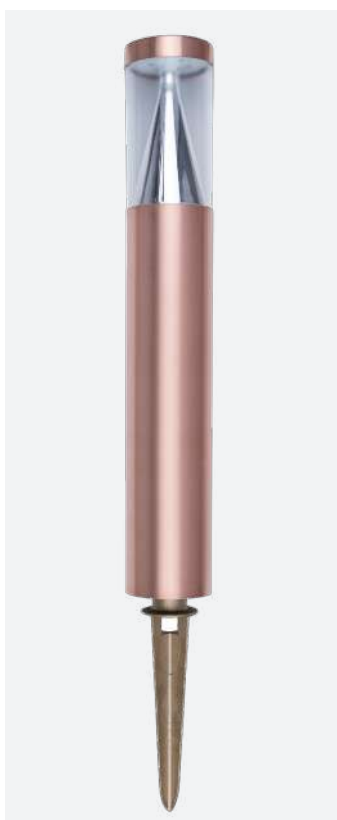

PORTUS1SPC
(Copper / Spike Light)

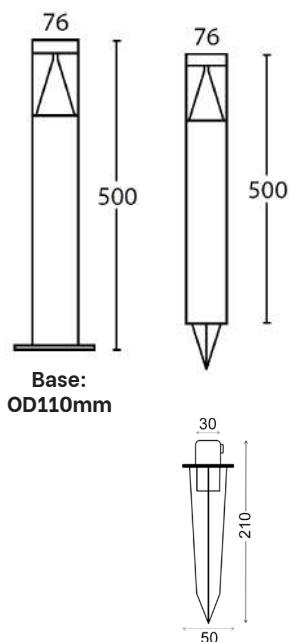

- Exterior bollard / spike lights
- Input voltage: 12-14V AC/DC 50/60Hz
- Nominal current: 150mA
- Material: 316 stainless steel or solid copper
- PORTUS1SP spike material: brass
- LED chips: 12pcs 2835 LED
- CRI: 75
- Cable length: 47mm
- Ambient temperature: -40 to 85°C
- For bollard lights, to maintain the IP rating please use circular cable in junction
- For bollard lights, for parallel and single connection we recommend using an appropriate IP68 connector

***These bollards are designed for mounting on a solid surface such as a concrete path or sturdy timber decking**



Tested & Recommended drivers:

DRIV1 / OTTER1 / CLA111011 / CLA113011 / CLA115011 / CLA1115011

Part No.	Description	Kelvin	Lumens	Watt	CRI	Dimensions	Mounting Plate	Carton QTY
PORTUS1FLC	BOLLARD LED 12V COP 3000K	3000K	620LM	6W	75	Ø76x500mm	Ø110mm	1/10
PORTUS1FLSS	BOLLARD LED 12V SS316 3000K	3000K	620LM	6W	75	Ø76x500mm	Ø110mm	1/10
PORTUS1SPC	SPIKE LED 12V COP 3000K	3000K	620LM	6W	75	Ø76x500mm	-	1/10

**To avoid disappointment and warranty problems, please ensure the IP Rating of the chosen product is relevant for the intended use.*

Shu Exterior Lighting



SHU1
(Wall Light)



- Exterior LED surface mounted wall & bollard lights
- Input voltage range: 100-240V AC 50/60Hz
- Inbuilt driver output range: 18-42V
- Housing: powder coated aluminium
- Mounting bracket: aluminium
- LED chip: 2pcs 5050
- Power factor: >0.5
- Ambient temperature: -20 to 50°C
- Suitable for 2-way switching
- Suitable for use with PIR or Microwave sensors
- For bollard lights, to maintain the IP rating please use circular cable in junction
- For bollard lights, for parallel and single connection we recommend using an appropriate IP68 connector

*These bollards are designed for mounting on a solid surface such as a concrete path or sturdy timber decking

30,000hr Lifetime	2x64.5° Beam Angle	IP65 Rated	3YEAR Replacement Warranty
----------------------	-----------------------	----------------------	---



SHU2
(Bollard Light H300mm)



SHU3
(Bollard Light H500mm)

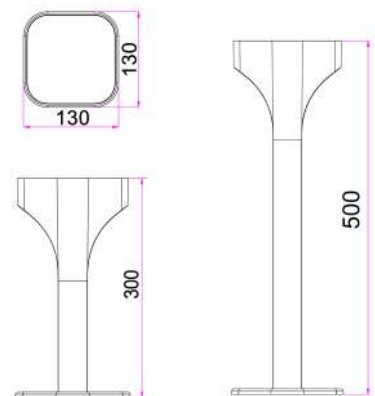
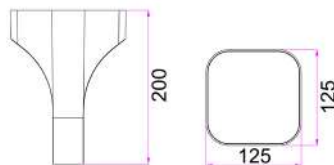

Part No.	Description	Kelvin	Lumens	Watt	PF	CRI	Dimensions	Mounting Plate	Carton QTY
SHU1	WALL LED S/M Dark Grey 2 way	3000K	540LM	11W	>0.5	80	125x125x200mm	-	1/8
SHU2	BOLLARD LED Dark Grey 2 way	3000K	540LM	11W	>0.5	80	H 300mm	130x130mm	1/8
SHU3	BOLLARD LED Dark Grey 2 way	3000K	540LM	11W	>0.5	80	H 500mm	130x130mm	1/4

*To avoid disappointment and warranty problems, please ensure the IP Rating of the chosen product is relevant for the intended use.

Geb Exterior Lighting



GEB1
(Wall Light)

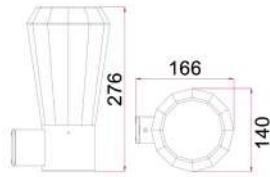

- Exterior LED surface mounted wall & bollard lights
- Input voltage rang: 100-240V 50/60Hz
- Output voltage range: 18-42V
- Material: aluminium post, die-cast & PC
- LED chips: 12pcs 3030
- Power factor: >0.5
- Ambient temperature: -20 to 50°C
- Not suitable for dimming
- Suitable for 2 way switching
- Suitable for use with PIR or Microwave sensors
- For bollard lights, to maintain the IP rating please use circular cable in junction
- For bollard lights, for parallel and single connection we recommend using an appropriate IP68 connector

***These bollards are designed for mounting on a solid surface such as a concrete path or sturdy timber decking**



GEB2
(Bollard Light H500mm)



GEB3
(Bollard Light H800mm)

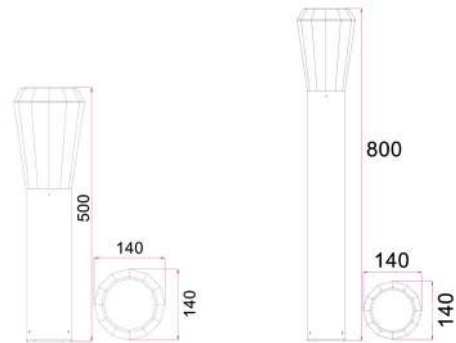

GEB2 & 3 Pole base OD: 90mm ID: 29mm

Part No.	Description	Kelvin	Lumens	Watt	PF	CRI	Dimensions	Mounting Plate	Carton QTY
GEB1	WALL LED S/M Dark Grey Tapered	3000K	580LM	13W	>0.5	>80	L 276 x W 140mm	-	1/8
GEB2	BOLLARD LED Dark Grey Tapered	3000K	580LM	13W	>0.5	>80	H 500mm	Ø90mm	1/4
GEB3	BOLLARD LED Dark Grey Tapered	3000K	580LM	13W	>0.5	>80	H 800mm	Ø90mm	1/4

**Unless protected, not recommended for environments with harsh weather conditions or heavy rainfall. IP65 fittings recommended for such environments. To avoid disappointment and warranty problems, please ensure the IP Rating of the chosen product is relevant for the intended use.*

Amun Exterior Lighting



AMUN1
(Wall Light)

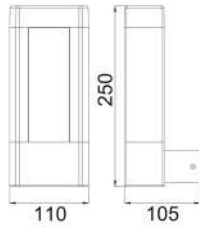

- Exterior LED surface mounted wall & bollard lights
- Input voltage range: 100-240V AC 50/60Hz
- Constant current driver included
- Material: double anti-corrosion powder coated high-pressure cast aluminium & anti aging UV protected PC diffuser
- All products have diffusers both front & back
- Comes with stainless steel screws
- LED chips: 2835 LED
- Power factor: >0.5
- Ambient temperature: -20 to 50°C
- Not suitable for dimming
- Suitable for 2-way switching
- Suitable for use with PIR or Microwave sensors
- For bollard lights, to maintain the IP rating please use circular cable in junction
- For bollard lights, for parallel and single connection we recommend using an appropriate IP68 connector

***These bollards are designed for mounting on a solid surface such as a concrete path or sturdy timber decking**



AMUN4
(Bollard Light H800mm)



AMUN3
(Bollard Light H500mm)



AMUN2
(Bollard Light H300mm)

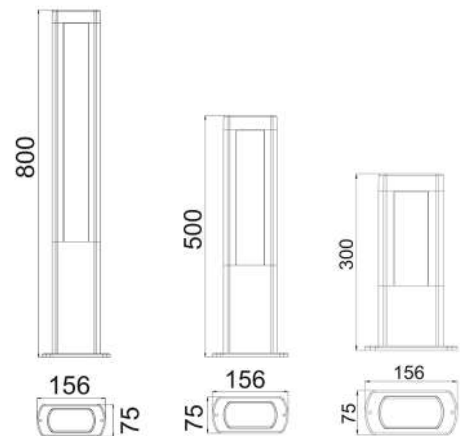

Part No.	Description	Kelvin	Lumens	Watt	PF	CRI	Dimensions	Mounting Plate	Carton QTY
AMUN1	WALL LED S/M Matte Black Rect	3000K	560LM	10w	>0.5	>80	L 250 x W 110mm	-	1/6
AMUN2	BOLLARD LED Matte Black Rect	3000K	560LM	10w	>0.5	>80	H 300mm	156x75mm	1/8
AMUN3	BOLLARD LED Matte Black	3000K	645LM	12.5w	>0.5	>80	H 500mm	156x75mm	1/4
AMUN4	BOLLARD LED Matte Black	3000K	756LM	12.5w	>0.5	>80	H 800mm	156x75mm	1/4

**Unless protected, not recommended for environments with harsh weather conditions or heavy rainfall. IP65 fittings recommended for such environments. To avoid disappointment and warranty problems, please ensure the IP Rating of the chosen product is relevant for the intended use.*

Hathor Exterior Lighting

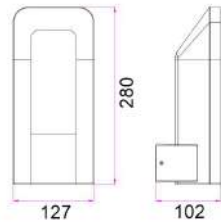

HATHOR1
(Wall Light)

- Exterior LED surface mounted wall & bollard lights
- Input voltage range: 100-240V AC 50/60Hz
- Inbuilt constant current driver included
- Driver output voltage range: 18-42V
- Housing & heatsink: powder coated-aluminium
- Diffuser: PC
- HATHOR1 back plate: PC
- HATHOR2-3 surface mounting plate: die cast aluminium
- Power factor: >0.5
- Ambient temperature: -20 to 50°C
- Not suitable for use with dimmers
- Suitable for 2-way switching
- Suitable for use with PIR or Microwave sensors
- For bollard lights, to maintain the IP rating please use circular cable in junction
- For bollard lights, for parallel and single connection we recommend using an appropriate IP68 connector

***These bollards are designed for mounting on a solid surface such as a concrete path or sturdy timber decking**

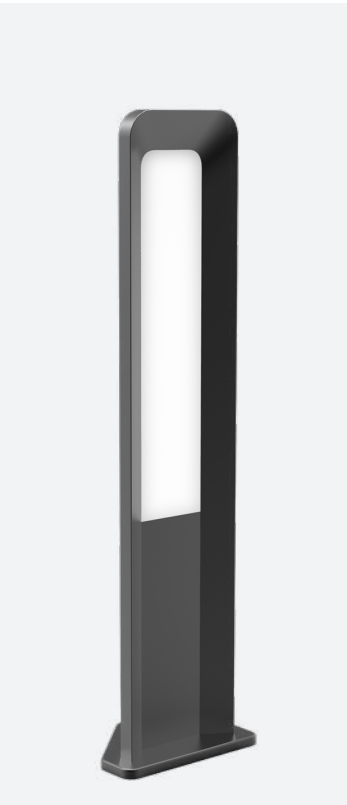

HATHOR2
(Bollard Light H500mm)

HATHOR3
(Bollard Light H800mm)

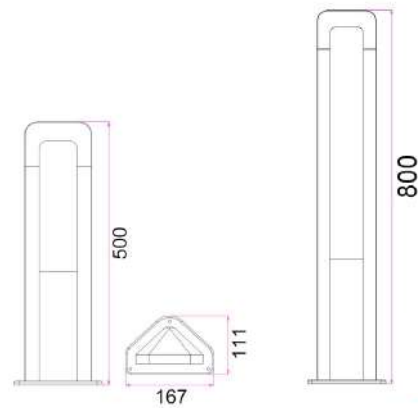

Part No.	Description	Kelvin	Lumens	Watt	PF	CRI	Dimensions	Mounting Plate	Carton QTY
HATHOR1	WALL LED DARK GREY S/M	3000K	175.58LM	9W	>0.5	>80	280x127x102mm	-	1/8
HATHOR2	BOLLARD LED DARK GREY	3000K	242.19LM	13W	>0.5	>80	H 500mm	167x111mm	1/4
HATHOR3	BOLLARD LED DARK GREY	3000K	242.19LM	13W	>0.5	>80	H 800mm	167x111mm	1/4

**Unless protected, not recommended for environments with harsh weather conditions or heavy rainfall. IP65 fittings recommended for such environments. To avoid disappointment and warranty problems, please ensure the IP Rating of the chosen product is relevant for the intended use.*

Seth Exterior Lighting



SETH1
(Wall Light)

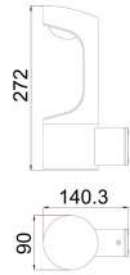

- Exterior LED surface mounted wall & bollard lights
- Input voltage range: 100-240V AC 50/60Hz
- Constant current driver included
- Material: double anti-corrosion powder coated high-pressure cast aluminium & anti aging UV protected PC diffuser
- LED chips: 8pcs 3030 LED
- Power factor: >0.5
- Ambient temperature: -20 to 50°C
- Not suitable for dimming
- Suitable for 2-way switching
- Suitable for use with PIR or Microwave sensors
- For bollard lights, to maintain the IP rating please use circular cable in junction
- For bollard lights, for parallel and single connection we recommend using an appropriate IP68 connector

***These bollards are designed for mounting on a solid surface such as a concrete path or sturdy timber decking**



SETH4
(Bollard Light H800mm)



SETH3
(Bollard Light H500mm)



SETH2
(Bollard Light H300mm)

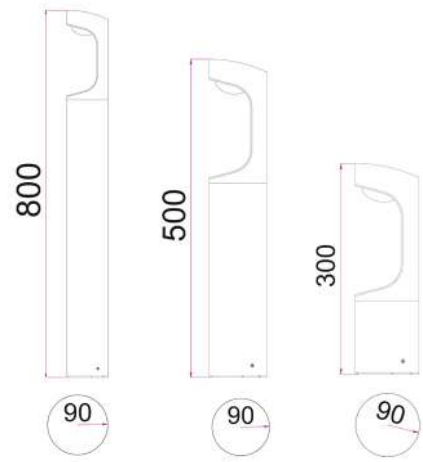

SETH4 **SETH3** **SETH2**

Part No.	Description	Kelvin	Lumens	Watt	PF	CRI	Dimensions	Mounting Plate	Carton QTY
SETH1	WALL LED 240V S/M Matte Black	3000K	428.76LM	9W	>0.5	>80	L 272 x W 90mm	-	1/8
SETH2	BOLLARD LED Matte Black	3000K	428.76LM	9W	>0.5	>80	H 300mm	Ø90mm	1/9
SETH3	BOLLARD LED Matte Black	3000K	428.76LM	9W	>0.5	>80	H 500mm	Ø90mm	1/9
SETH4	BOLLARD LED Matte Black	3000K	428.76LM	9W	>0.5	>80	H 800mm	Ø90mm	1/9

**Unless protected, not recommended for environments with harsh weather conditions or heavy rainfall. IP65 fittings recommended for such environments. To avoid disappointment and warranty problems, please ensure the IP Rating of the chosen product is relevant for the intended use.*

Horus Exterior Lighting



HORUS1
(Wall Light)



- Exterior LED surface mounted wall & bollard lights
- Input voltage range: 100-240V AC 50/60Hz
- Constant current driver included
- Material: double anti-corrosion powder coated high-pressure cast aluminium & anti aging UV protected PC diffuser
- Comes with stainless steel screws
- LED chips: 8pcs 3030 LED
- Power factor: >0.5
- Ambient temperature: -20 to 50°C
- Not suitable for dimming
- Suitable for 2-way switching
- Suitable for use with PIR or Microwave sensors
- For bollard lights, to maintain the IP rating please use circular cable in junction
- For bollard lights, for parallel and single connection we recommend using an appropriate IP68 connector

***These bollards are designed for mounting on a solid surface such as a concrete path or sturdy timber decking**



HORUS4

(Bollard Light H800mm)



HORUS3

(Bollard Light H500mm)



HORUS2

(Bollard Light H300mm)

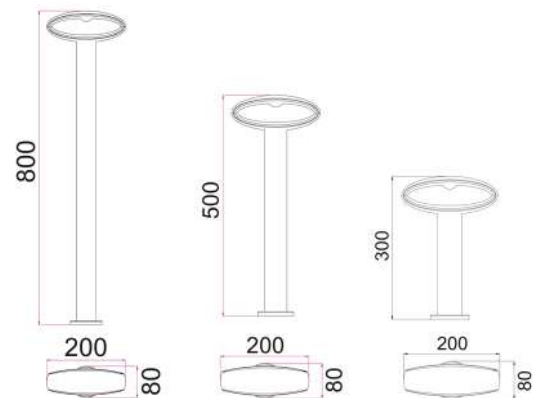

HORUS4

HORUS3

HORUS2

Part No.	Description	Kelvin	Lumens	Watt	PF	CRI	Dimensions	Carton QTY
HORUS1	WALL LED S/M Matte Black Crescent	3000K	364LM	9W	>0.5	>80	L 200x W66.6mm	1/8
HORUS2	BOLLARD LED Matte Black Open Oval	3000K	368LM	9W	>0.5	>80	H 300mm	1/8
HORUS3	BOLLARD LED Matte Black Open Oval	3000K	350LM	9W	>0.5	>80	H 500mm	1/4
HORUS4	BOLLARD LED Matte Black Open Oval	3000K	355LM	9W	>0.5	>80	H 800mm	1/4

**Unless protected, not recommended for environments with harsh weather conditions or heavy rainfall. IP65 fittings recommended for such environments. To avoid disappointment and warranty problems, please ensure the IP Rating of the chosen product is relevant for the intended use.*

Toren Exterior Lighting



- Exterior LED Tri-CCT bollard light
- Input voltage: 100-240V 50/60Hz
- Inbuilt Constant Current LED driver
- Housing: powder coated Aluminium
- Heat sink: Aluminium
- Mounting plate: PC
- LED chips: 24pcs 2835 SMD
- Tri-CCT (3000K/ 4000K/ 6500K) in one fitting
- CCT switch inside the fitting
- CRI: >80
- Power factor: >0.8
- Ambient temperature: -20 to 50°C
- Not suitable for dimming
- Suitable for 2 way switching
- Suitable for use with sensor
- For bollard lights, to maintain the IP rating please use circular cable in junction
- For bollard lights, for parallel and single connection we recommend using an appropriate IP68 connector

***These bollards are designed for mounting on a solid surface such as a concrete path or sturdy timber decking**



TOREN1
(Bollard Light H800mm)

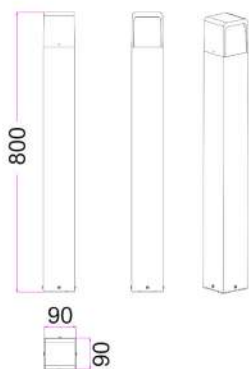

Part No.	Description	Lumens			Watt	PF	CRI	Dimensions	Mounting Plate	Carton QTY
		3000K	4000K	6500K						
TOREN1	BOLLARD LED Dark Grey	214LM	236LM	211LM	13W	0.8	80	H 800mm	90x90mm	1/4

**To avoid disappointment and warranty problems, please ensure the IP Rating of the chosen product is relevant for the intended use.*

Seker Exterior Lighting



SEKER1
(Bollard Light H300mm)



SEKER2
(Bollard Light H500mm)

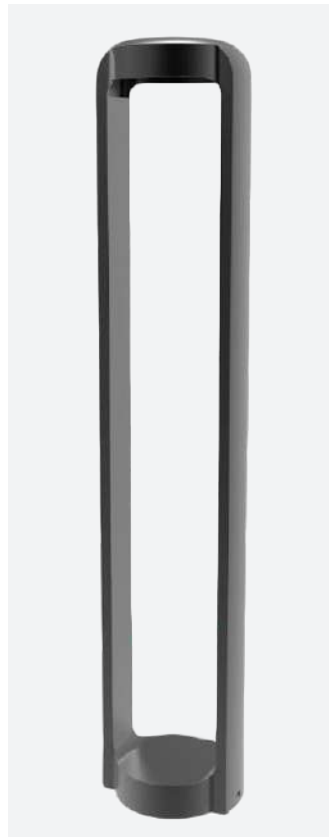

SEKER3
(Bollard Light H800mm)

- Exterior LED surface mounted bollard lights
- Input voltage range: 100-240V AC 50/60Hz
- Inbuilt driver output range: 18-42V
- Housing: powder coated aluminium
- Heatsink & mounting bracket: aluminium
- LED chip: 1pc 7070
- Power factor: >0.5
- Ambient temperature: -20 to 50°C
- Not for use inground
- Not suitable for dimming
- Suitable for 2-way switching
- Suitable for use with PIR or Microwave sensors
- For bollard lights, to maintain the IP rating please use circular cable in junction
- For bollard lights, for parallel and single connection we recommend using an appropriate IP68 connector

***These bollards are designed for mounting on a solid surface such as a concrete path or sturdy timber decking**

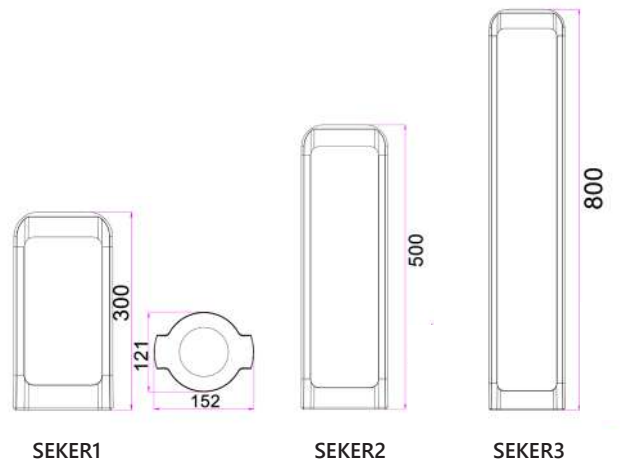

Part No.	Description	Kelvin	Lumenes	Watt	PF	CRI	Dimensions	Mounting Plate	Carton QTY
SEKER1	BOLLARD LED Dark Grey Short	3000K	530LM	13W	>0.5	80	H 300mm	152x121mm	1/8
SEKER2	BOLLARD LED Dark Grey med	3000K	530LM	13W	>0.5	80	H 500mm	152x121mm	1/4
SEKER3	BOLLARD LED Dark Grey long	3000K	530LM	13W	>0.5	80	H 800mm	152x121mm	1/4

**To avoid disappointment and warranty problems, please ensure the IP Rating of the chosen product is relevant for the intended use.*

Bol Exterior Lighting



BOL1A
(Bollard Light H800mm)

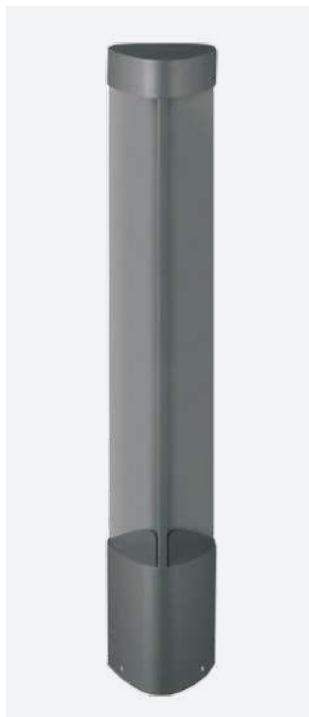

BOL2A
(Bollard Light H800mm)

- Exterior LED surface mounted bollard lights
- Input voltage range: 100-240V AC 50/60Hz
- Inbuilt driver output voltage range: 18-42V
- Housing: powder coated aluminium
- Heatsink & mounting bracket: aluminium
- LED chip: 1pc 7070
- Power factor: >0.5
- Ambient temperature: -20 to 50°C
- Not for use inground
- Not suitable for dimming
- Suitable for 2-way switching
- For bollard lights, to maintain the IP rating please use circular cable in junction
- For bollard lights, for parallel and single connection we recommend using an appropriate IP68 connector

***These bollards are designed for mounting on a solid surface such as a concrete path or sturdy timber decking**

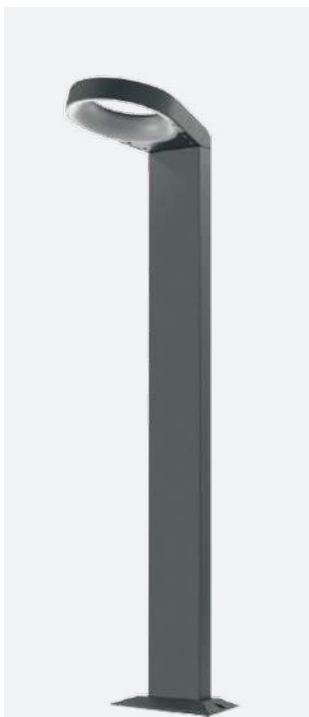

BOL3A
(Bollard Light H800mm)



BOL4A
(Bollard Light H800mm)

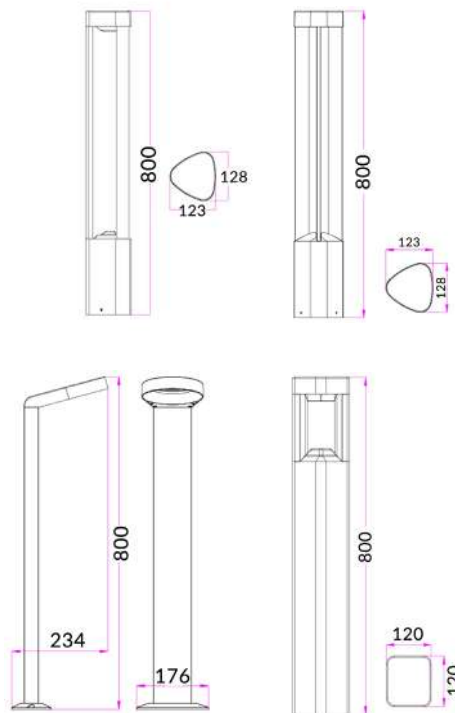

Part No.	Description	Kelvin	Lumens	Watt	Beam Angle	PF	CRI	Height	Mounting Plate	Carton QTY
BOL1A	BOLLARD LED GREY 3 SECTIONS	3000K	216LM	7W	197°	>0.5	>80	800mm		1/4
BOL2A	BOLLARD LED GREY TRIANGULAR	3000K	120LM	7W	106°	>0.5	>80	800mm	see line drawings above	1/4
BOL3A	BOLLARD LED GREY HOOP	3000K	211LM	7W	119°	>0.5	>80	800mm		1/4
BOL4A	BOLLARD LED GREY SQUARE	3000K	193LM	7W	343°	>0.5	>80	800mm		1/4

**Unless protected, not recommended for environments with harsh weather conditions or heavy rainfall. IP65 fittings recommended for such environments. To avoid disappointment and warranty problems, please ensure the IP Rating of the chosen product is relevant for the intended use.*

Coolie Exterior Lighting



COOLIE01
(Rustic Brass)



COOLIE02
(Matte Black)

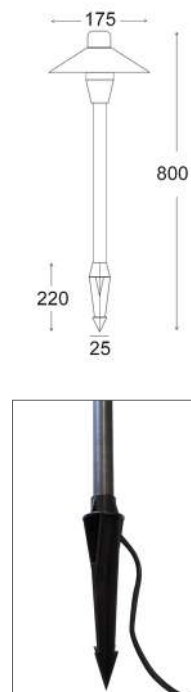

- Exterior garden spike lights
- Input voltage range: 12-25V
- Material: solid brass / aluminium
- Colour: rustic antique brass / matte black
- Lamp holder: G4 (Max.20W)
- Globe not included
- Flex: 920mm
- External control gear required
- For bollard lights, to maintain the IP rating please use circular cable in junction
- For bollard lights, for parallel and single connection we recommend using an appropriate IP68 connector

Tested & Recommended CLA Globes:

- CLAESH12V14W
- CLAL1.58 B / G / R / Y
- CLAG4L3WW / CW
- CLAG4L15WW / CW



Part No.	Description	Lamp Holder	Max. Watt	Diam	Total Length	Spike L	Carton QTY
COOLIE01	SPIKE G4 12V FIXED Rustic Brass	1xG4	20W	Ø175mm	800mm	220mm	1/10
COOLIE02	SPIKE G4 12V FIXED Matte Black	1xG4	20W	Ø175mm	800mm	220mm	1/10

*Unless protected, not recommended for environments with harsh weather conditions or heavy rainfall. IP65 fittings recommended for such environments. To avoid disappointment and warranty problems, please ensure the IP Rating of the chosen product is relevant for the intended use.

Spm Exterior Lighting



SPMSBL
(Aluminium Black)



SPMSC
(Copper)



SPMSSS
(316 Stainless Steel)



SPMST
(Aluminium Titanium)



SPMSBR1
(Aged Brass)



SPMSBR2
(Polished Brass)



SPMSBL86
(Aluminium Black)



SPMSSS86
(316 Stainless Steel)

- Exterior garden spike lights
- Input voltage range: 12-25V AC/DC
- Material: aluminium, copper, brass & 316 stainless steel
- Lamp holder: MR16 (Max.20W)
- Globes not included
- Cable included (L 2000mm)
- External control gear required
- For bollard lights, to maintain the IP rating please use circular cable in junction
- For bollard lights, for parallel and single connection we recommend using an appropriate IP68 connector



90° Tilt/ 270° Swivel

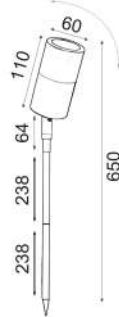

SPMS

90° Tilt/ 270° Swivel

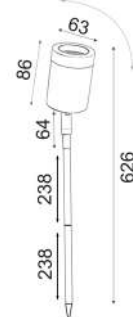

SPMS 86

Part No.	Description	Lamp Holder	Max. Watt	Height	Barrel	Carton QTY
SPMSBL	SPIKE MR16 12V S/ADJ BLK L650mm	1xMR16	20W	650mm	110xØ60mm	1/20
SPMSBR1	SPIKE MR16 12V AGED BRASS L650mm	1xMR16	20W	650mm	110xØ60mm	1/20
SPMSBR2	SPIKE MR16 12V POLISHED BRASS L650mm	1xMR16	20W	650mm	110xØ60mm	1/20
SPMSC	SPIKE MR16 12V S/ADJ COP L650mm	1xMR16	20W	650mm	110xØ60mm	1/10
SPMSSS	SPIKE MR16 12V S/ADJ 316 SS L650mm	1xMR16	20W	650mm	110xØ60mm	1/10
SPMST	SPIKE MR16 12V S/ADJ TITANIUM L650mm	1xMR16	20W	650mm	110xØ60mm	1/20
SPMSBL86	SPIKE MR16 S/ADJ BLK L626mm	1xMR16	20W	626mm	86xØ63mm	1/20
SPMSSS86	SPIKE MR16 S/ADJ 316 SS L626mm	1xMR16	20W	626mm	86xØ63mm	1/10

*To avoid disappointment and warranty problems, please ensure the IP Rating of the chosen product is relevant for the intended use.



SPM1ALC
(Copper)

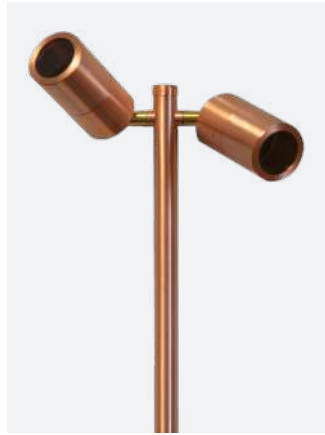

SPM2ALC
(Copper)



SPM1ALSS
(316 Stainless steel)



SPM2ALSS
(316 Stainless steel)



SPM1ALBL
(Aluminium black)



SPM2ALBL
(Aluminium black)



- Exterior garden spike lights
- Input voltage range: 12-25V AC/DC
- Material: solid copper/ 316 stainless steel/ aluminium
- Lamp holder: MR16 (Max.20W)
- Globes not included
- Spike length: 1000mm
- Cable included (L 900mm)
- External control gear required
- For bollard lights, to maintain the IP rating please use circular cable in junction
- For bollard lights, for parallel and single connection we recommend using an appropriate IP68 connector

MR16	IP65 Rated	2YEAR Replacement Warranty
------	----------------------	---

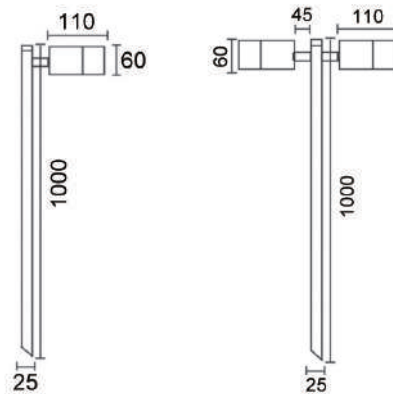

Part No.	Description	Lamp Holder	Max. Watt	Height	Barrel	Carton QTY
SPM1ALBL	SPIKE MR16 12V S/ADJ AL BLK L1000mm	1xMR16	20W	1000mm	110xØ60mm	1/10
SPM1ALC	SPIKE MR16 12V S/ADJ COP L1000mm	1xMR16	20W	1000mm	110xØ60mm	1/10
SPM1ALSS	SPIKE MR16 12V S/ADJ SS316 L1000mm	1xMR16	20W	1000mm	110xØ60mm	1/10
SPM2ALBL	SPIKE MR16 12V D/ADJ AL BLK L1000mm	2xMR16	20W	1000mm	110xØ60mm	1/10
SPM2ALC	SPIKE MR16 12V D/ADJ COP L1000mm	2xMR16	20W	1000mm	110xØ60mm	1/10
SPM2ALSS	SPIKE MR16 12V D/ADJ SS316 L1000mm	2xMR16	20W	1000mm	110xØ60mm	1/10

*To avoid disappointment and warranty problems, please ensure the IP Rating of the chosen product is relevant for the intended use.

Phare Exterior Lighting

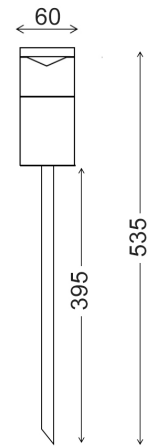

PHARE06M
(Titanium Anodized)

PHARE07M
(Black)

- Exterior garden spike lights
- Input voltage range: 12-25V
- Housing: aluminium & acrylic
- Lamp holder: MR16 (Max.20W)
- Globe not included
- Flex: 1100mm
- Anti-glare
- External control gear required
- For bollard lights, to maintain the IP rating please use circular cable in junction
- For bollard lights, for parallel and single connection we recommend using an appropriate IP68 connector

MR16

IP65
 Rated

2YEAR
 Replacement
 Warranty

Part No.	Description	Lamp Holder	Max. Watt	Barrel Diam	Barrel Length	Spike L	Carton QTY
PHARE06M	SPIKE MR16 12V FIXED Titanium Anodized	1xMR16	20W	Ø60mm	140mm	400mm	1/10
PHARE07M	SPIKE MR16 12V FIXED Powder Coated BLK	1xMR16	20W	Ø60mm	140mm	400mm	1/10

**To avoid disappointment and warranty problems, please ensure the IP Rating of the chosen product is relevant for the intended use.*

Kolec & Kam Exterior Lighting

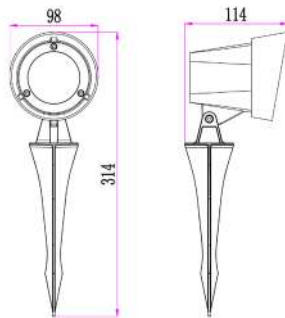

- Exterior LED garden spike light
- Input voltage: 12V
- Material: die cast aluminium
- Spike material: PC
- Diffuser: clear glass
- Adjustable up/down head : 10-80°
- LED chip: 1 COB
- Power factor: >0.5
- CRI: >80
- Flex only: 1m
- Ambient temp: -20 to 50°C
- Suitable for 2 way switching
- Suitable for use with Microwave or PIR sensors
- Constant voltage driver required.
- Recommended CLA 12V waterproof LED drivers
- For bollard lights, to maintain the IP rating please use circular cable in junction
- For bollard lights, for parallel and single connection we recommend using an appropriate IP68 connector



KOLEC1
(Dark Grey)

Part No.	Description	Colour	Kelvin	Lumens	Watt	Carton QTY
KOLEC1	SPIKE/HOOD (Dark Grey) Adj 12V L314mm	Dark Grey	3000K	930LM	13W	1/12



- Exterior garden spike lights
- Input voltage: 12V
- Material: powder coated aluminium
- Lamp holder: MR16 (Max.20W)
- Globe not included
- Flex: 1000mm
- External control gear required
- For bollard lights, to maintain the IP rating please use circular cable in junction
- For bollard lights, for parallel and single connection we recommend using an appropriate IP68 connector



KAM01
(Dark Grey)

Part No.	Description	Colour	Lamp Holder	Max. Watt	Carton QTY
KAM01	SPIKE/HOOD (Dark Grey) 20W MR16 IP65	Dark Grey	1xMR16	20W	1/12

*To avoid disappointment and warranty problems, please ensure the IP Rating of the chosen product is relevant for the intended use.

Pond / Spot Light Exterior Lighting



- Surface mount adjustable pond/ spot light
- Input voltage: 12-24V
- Material: 316 stainless steel
- Lamp holder: MR16 (Max.35W)
- Globe not included
- IP rating: IP68
- Flex: 900mm
- For bollard lights, to maintain the IP rating please use circular cable in junction
- For bollard lights, for parallel and single connection we recommend using an appropriate IP68 connector

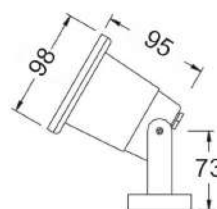

SMIP68ASS

Part No.	Description	Colour	Lamp Holder	Max. Watt	Carton QTY
SMIP68ASS	SPOT 12V MR16 35W S/M SS316 (5mm tempered glass)	316 Stainless steel	1xMR16	35W	1/10

**To avoid disappointment and warranty problems, please ensure the IP Rating of the chosen product is relevant for the intended use.*

Deck Exterior Lighting



DECK01 & DECK02
(316 Stainless Steel)



DECK03 & DECK04
(Copper)

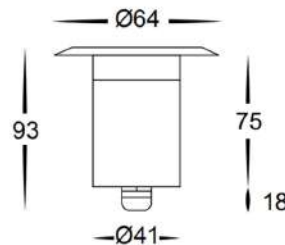

- Exterior LED deck lights
- Input voltage range: 9-14V DC
- Faceplate: 316 stainless steel / copper
- Housing: aluminium
- Diffuser: PVC
- Flex: 900mm
- LED chip: 1pc Brightlux 45mil
- Power factor: 0.98
- CRI: 80
- Ambient temperature: -20 to 50°C
- Not suitable for dimming
- External control gear required
- IP68 connectors must be used
- For bollard lights, to maintain the IP rating please use circular cable in junction
- For bollard lights, for parallel and single connection we recommend using an appropriate IP68 connector

Tested & Recommended Drivers:

Indoor drivers: DRIV1 / CLADR12WFP

Weather Proof drivers: OTTER1 / CLA111011 / CLA113011 / CLA115011 / CLA1110011 / CLA1120011 / OTTER5



30,000hr
Lifetime

30°
Beam Angle

IP67
Rated

2YEAR
Replacement
Warranty

Part No.	Description	Colour	Kelvin	Lumens	Watt	CRI	Cut out	Carton QTY
DECK01	DECK LIGHT LED 3000K 12V 3W 43MM	Stainless Steel	3000K	160LM	3W	80	Ø43mm	1/50
DECK02	DECK LIGHT LED 6000K 12V 3W 43MM	Stainless Steel	6000K	180LM	3W	80	Ø43mm	1/50
DECK03	DECK LIGHT LED 3000K 12V 3W 43MM	Natural Copper	3000K	160LM	3W	80	Ø43mm	1/50
DECK04	DECK LIGHT LED 6000K 12V 3W 43MM	Natural Copper	6000K	180LM	3W	80	Ø43mm	1/50

*To avoid disappointment and warranty problems, please ensure the IP Rating of the chosen product is relevant for the intended use.

GU10 Inground Up Lights Exterior Lighting



IGGLSQSS
(316 Stainless Steel)



IGGLSS
(316 Stainless Steel)

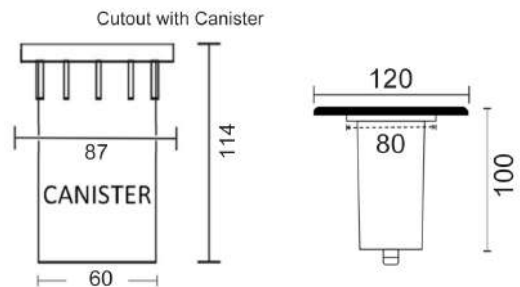

- Exterior recessed inground up lights
- Input voltage : 240V AC
- Faceplate: 316 stainless steel
- Housing: aluminium
- Lamp holder: GU10 (Max.35W)
- Globe not included
- Plastic sleeve included (must be installed)
- Fitting slides and screws into sleeve
- Cable included (L950mm)
- 8mm tempered glass, max load capacity 600kg
- For bollard lights, to maintain the IP rating please use circular cable in junction
- For bollard lights, for parallel and single connection we recommend using an appropriate IP68 connector

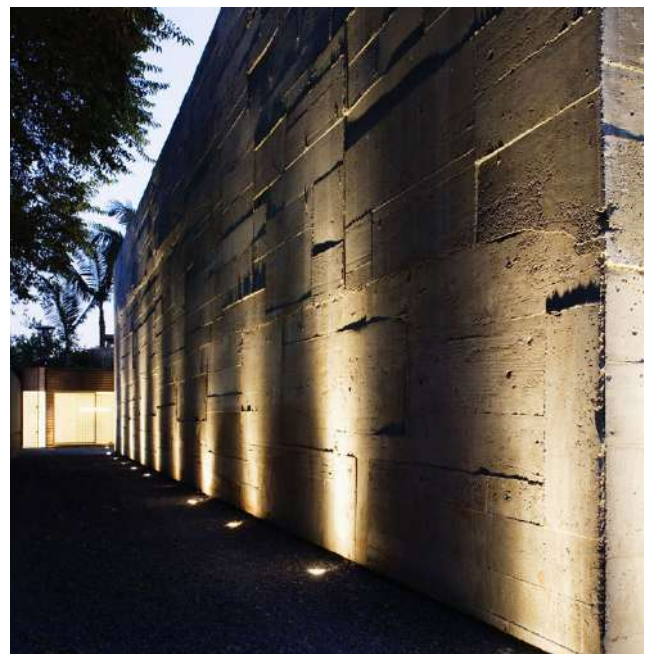

Part No.	Description	Colour	Lamp Holder	Max. Watt	Faceplate	Carton QTY
IGGLSQSS	INGROUND / WALL GU10 SS316 LGE SQ	316 SS clear anodized	1xGU10	35W	120x120mm	1/10
IGGLSS	INGROUND / WALL GU10 SS316 LGE RND	316 SS clear anodized	1xGU10	35W	Ø120mm	1/10

**To avoid disappointment and warranty problems, please ensure the IP Rating of the chosen product is relevant for the intended use.*

MR16 Inground Up Lights Exterior Lighting



IGMLSQBR
(Solid Brass)



IGMLBR
(Solid Brass)



IGMLSQC
(Solid Copper)



IGMLC
(Solid Copper)



IGMLSQSS
(316 Stainless Steel)



IGMLSS
(316 Stainless Steel)

- Exterior recessed inground up lights
- Input voltage range: 12-25V DC / AC
- External Control Gear Required
- Housing: aluminium
- Faceplate: 316 Stainless steel, solid copper or solid brass
- Lamp holder: MR16 (Max.20W)
- Globe not included
- Plastic sleeve included (must be installed)
- Fitting slides and screws into sleeve
- Cable included (L950mm)
- 8mm tempered glass, max load capacity 600kg
- For bollard lights, to maintain the IP rating please use circular cable in junction
- For bollard lights, for parallel and single connection we recommend using an appropriate IP68

MR16

IP67
 Rated

2YEAR
 Replacement
 Warranty

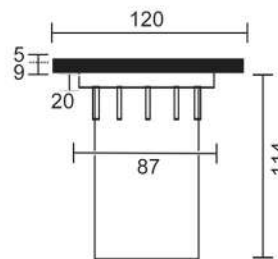

Part No.	Description	Colour	Lamp Holder	Max. Watt	Faceplate	Carton QTY
IGMLBR	INGROUND / WALL MR16 12V Brass LGE RND	Aged Brass	MR16	20W	Ø120mm	1/20
IGMLC	INGROUND / WALL MR16 12V COP LGE RND	Polished Copper	MR16	20W	Ø120mm	1/20
IGMLSS	INGROUND / WALL MR16 12V SS316 LGE RND	316 SS clear anodized	MR16	20W	Ø120mm	1/20
IGMLSQBR	INGROUND / WALL MR16 12V Brass LGE SQ	Aged Brass	MR16	20W	120x120mm	1/20
IGMLSQC	INGROUND / WALL MR16 12V COP LGE SQ	Polished Copper	MR16	20W	120x120mm	1/20
IGMLSQSS	INGROUND / WALL MR16 12V SS316 LGE SQ	316 SS clear anodized	MR16	20W	120x120mm	1/20

*To avoid disappointment and warranty problems, please ensure the IP Rating of the chosen product is relevant for the intended use.

MR16 Inground Up Lights Exterior Lighting



IGM1SS
(1 Way)



IGM2SS
(2 Way)



IGML3SS
(3 Way)



IGML4SS
(4 Way)

- Exterior recessed inground up lights
- Input voltage range: 12-25V DC / AC
- External Control Gear Required
- Housing & faceplate: 316 Stainless steel
- Lamp holder: MR16 (Max.20W)
- Globe not included
- Plastic sleeve included (must be used when installing in concrete)
- Fitting slides into sleeve and remains unattached
- Cable included (L950mm)
- 4mm tempered glass, max load capacity 100kg
- For bollard lights, to maintain the IP rating please use circular cable in junction
- For bollard lights, for parallel and single connection we recommend using an appropriate IP68 connector

MR16

IP67
 Rated

2YEAR
 Replacement
 Warranty

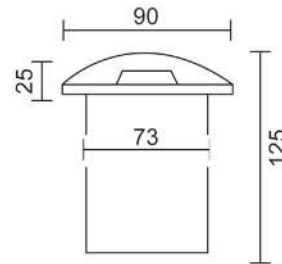

Part No.	Description	Colour	Lamp Holder	Max. Watt	Faceplate	Carton QTY
IGM1SS	INGROUND / WALL 1 WAY MR16 12V SS316 RND	316 SS	1xMR16	20W	Ø90mm	1/20
IGM2SS	INGROUND / WALL 2 WAY MR16 12V SS316 RND	316 SS	1xMR16	20W	Ø90mm	1/20
IGM3SS	INGROUND / WALL 3 WAY MR16 12V SS316 RND	316 SS	1xMR16	20W	Ø90mm	1/20
IGM4SS	INGROUND / WALL 4 WAY MR16 12V SS316 RND	316 SS	1xMR16	20W	Ø90mm	1/20

**To avoid disappointment and warranty problems, please ensure the IP Rating of the chosen product is relevant for the intended use.*

MR16 Inground Up Lights (Small Faceplate) Exterior Lighting



IGMEYEC
(Eyelid / Copper)



IGMEYESS
(Eyelid / 316 Stainless Steel)



IGMSMC
(Round / Copper)



IGMSMSS
(Round / 316 Stainless Steel)



IGMGRSS
(Grilled / 316 Stainless Steel)

- Exterior recessed inground up lights
- Input voltage range: 12-25V AC/DC
- External Control Gear Required
- Housing: 316 Stainless steel/ solid copper
- Faceplate: 316 Stainless steel/ solid copper
- Lamp holder: MR16 (Max.20W)
- Globe not included
- Plastic sleeve included (must be used when installing in concrete)
- Fitting slides into sleeve and remains unattached
- Cable included (L950mm)
- For bollard lights, to maintain the IP rating please use circular cable in junction
- For bollard lights, for parallel and single connection we recommend using an appropriate IP68 connector

MR16	IP67 Rated	2YEAR Replacement Warranty
------	----------------------	---

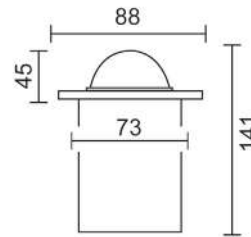

IGMEYE

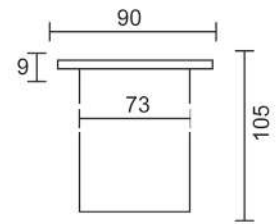

IGMSM & IGMGRSS

IGMEYEC	4mm Tempered Glass. Max load capacity 100Kg
IGMEYESS	4mm Tempered Glass. Max load capacity 100Kg
IGMSMC	4mm Tempered Glass. Max load capacity 600Kg
IGMSMSS	4mm Tempered Glass. Max load capacity 600Kg
IGMGRSS	4mm Tempered Glass. Max load capacity 600Kg

Part No.	Description	Colour	Lamp Holder	Max. Watt	Faceplate	Carton QTY
IGMEYEC	INGROUND / WALL EYELID MR16 12V COP RND	Polished Copper	1xMR16	20W	Ø88mm	1/20
IGMEYESS	INGROUND / WALL EYELID MR16 12V 316 SS RND	316 SS	1xMR16	20W	Ø88mm	1/20
IGMSMC	INGROUND / WALL MR16 12V COP SM RND	Polished Copper	1xMR16	20W	Ø90mm	1/20
IGMSMSS	INGROUND / WALL MR16 12V 316 SS SM RND	316 SS	1xMR16	20W	Ø90mm	1/20
IGMGRSS	INGROUND / WALL Grilled MR16 12V SS316 RND	316 SS	1xMR16	20W	Ø90mm	1/20

*To avoid disappointment and warranty problems, please ensure the IP Rating of the chosen product is relevant for the intended use.

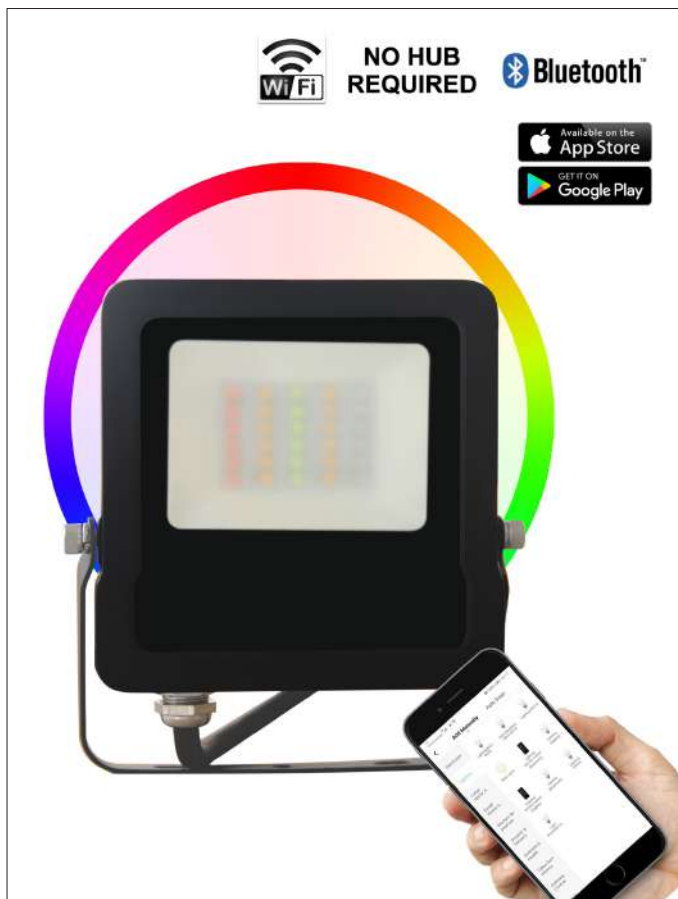

**NO HUB
REQUIRED**



- Input voltage range: 220-240V 50/60Hz
- Inbuilt constant current LED driver included
- Housing: powder coated aluminium
- Heatsink: aluminium
- Diffuser: glass
- LED chips: SMD2835
- CRI: ≥ 80
- Power factor: ≥ 0.9
- Ambient temperature: -20 to 40°C
- Flex & Plug: 1.2m
- App: control all functions via Tuya app on smart devices
- Manual: on/off control via normal wall switch
- Dimmable only via app or voice control through Amazon Alexa, Google Home and other compatible voice activated control devices (Not compatible with wall switch dimmer)
- Setup requires WiFi with Internet connection
- Suitable for 2-way switching
- Not suitable for use with sensor

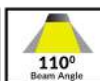

SMTFLOOD1 & SMTFLOOD2

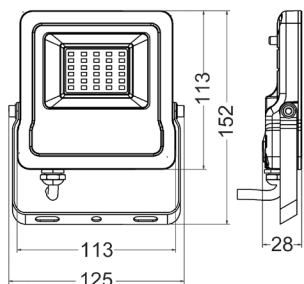

SMTFLOOD1

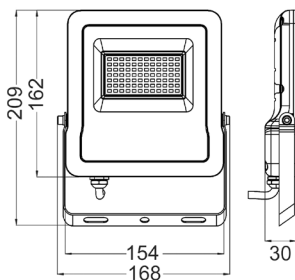

SMTFLOOD2

Additional SMART Features:

- Tuneable RGB colour spectrum (up to 14 million colours)
- Colour temperature: 5000K
- Works with any 2.4GHz enabled WiFi network (note: will not currently pair with 5.0GHz bandwidth.) or Bluetooth LE 4.2
- Create schedules plans, Biorhythm and timing to automate your home
- Ability to set power-on behaviour
- Control from anywhere via app or voice control using Alexa Hubs, Google Home and other compatible devices
- Compatible with all Tuya Powered apps



Formal version



Part No.	Description	Kelvin	Lumens	Watt	Product Dimensions	Carton QTY
SMTFLOOD1	FLOOD LED SMART Bik Dimm 5K+RGB 10W	5000K	800LM	10W	152x125x28mm	1/20
SMTFLOOD2	FLOOD LED SMART Bik Dimm 5K+RGB 30W	5000K	2400LM	30W	209x168x30mm	1/20

*To avoid disappointment and warranty problems, please ensure the IP Rating of the chosen product is relevant for the intended use.



SEC11S

- LED Tri-CCT adjustable security light with sensor
- Input voltage: 220-240V 50/60Hz
- Housing, faceplate & heatsink: plastic
- Diffuser: clear glass
- LED chips: 48pcs(3000K) + 48pcs (6500K) SMD2835
- Tri-CCT (3000K/ 4000K/ 6500K) in one fitting
- CCT switch inside the fitting
- Power Factor: >0.9
- CRI: >80
- Beam angle: 270° (3x90°)
- Adjustable / Tilt / Swivel: 270°
- Ambient temperature: -20 to 40°C
- Not suitable for dimming
- Suitable for 2 way switching
- Double insulated

Sensor Technical Spec:

- Sensor type: PIR
- Wattage / power consumption: <0.5W
- Installation height: 1.8-3.5m
- Detection angle: 140° Max
- Motion detection speed: 1.5m/s
- Time delay: 8secs to 9mins
- UV resistant: yes
- Manual override: yes

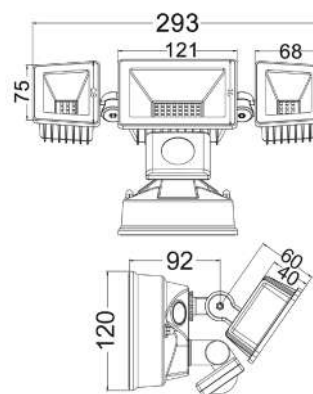

15,000hr
Lifetime

270°
Beam Angle

IP65
Rated

2YEAR
Replacement
Warranty

Part No.	Description	Lumens			Watt	PF	CRI	Carton QTY
		3000K	4000K	6500K				
SEC11S	SECURITY S/M 30W LED TRI Blk w/sensor	2700LM	3000LM	2800LM	10W	>0.9	>80	1/12

*To avoid disappointment and warranty problems, please ensure the IP Rating of the chosen product is relevant for the intended use.

Tablet & Flood Exterior Lighting



TABLET2B

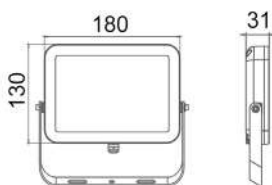

- LED slim flood light
- Input voltage range: 220-240V AC 50/60Hz
- Constant voltage driver included
- Housing & heatsink: aluminium
- Diffuser: clear shatter proof glass
- Mounting bracket: iron
- LED type: 35pcs SMD2835
- Power factor: >0.9
- CRI: 80
- Flex & plug: 1200mm
- Adjustable: 180°
- Ambient temperature: -20 to 40°C
- Not suitable for dimming
- Suitable for 2-way switching
- Suitable for use with PIR or Microwave sensors



Part No.	Description	Kelvin	Lumens	Watt	CRI	Beam Angle	Carton QTY
TABLET2B	FLOOD LED MATTE BLK SLIM 5000K 30W	5000K	2400lm	30W	80	110°	1/16



FLOOD15 & FLOOD16

- LED slim flood lights
- Input voltage: 240V 50/60Hz
- Housing: PC
- Bracket: aluminium
- LED chips: SMD 2835
- Power factor: ≥0.9
- Flex & plug not included
- Ambient temperature: -20 to 40°C
- Not suitable for dimming
- Suitable for 2-way switching
- Suitable for use with Microwave or PIR sensors

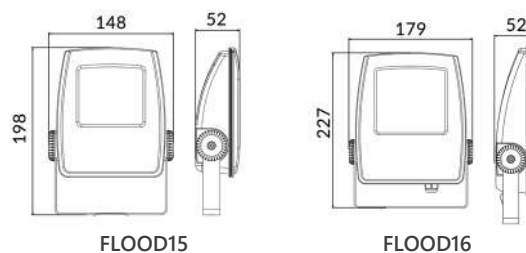

Part No.	Description	Kelvin	Lumens	Watt	CRI	Dimensions	Carton QTY
FLOOD15	FLOOD LED BLK P/C (aluminum bracket) 15W	5000K	1200LM	15W	80	148x198x52mm	1/10
FLOOD16	FLOOD LED BLK P/C (aluminum bracket) 30W	5000K	2200LM	30W	80	179x227x52mm	1/10

*To avoid disappointment and warranty problems, please ensure the IP Rating of the chosen product is relevant for the intended use.

Flood Exterior Lighting

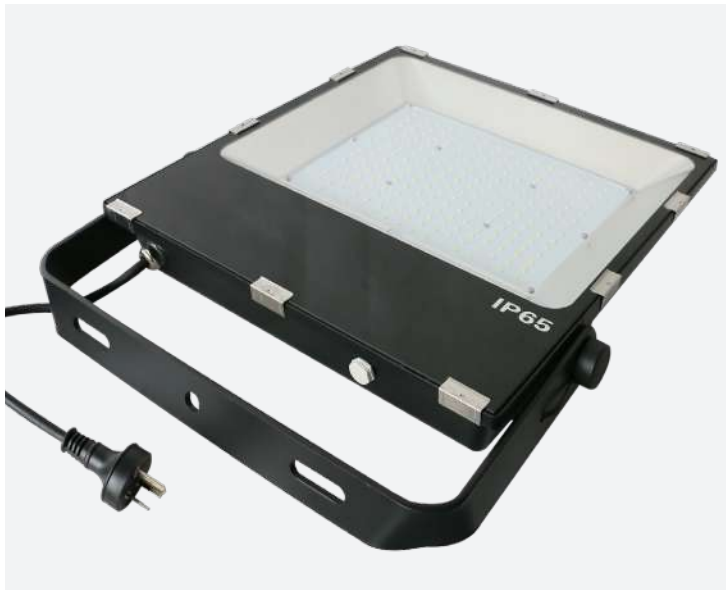

FLOOD22



Angled / offset bracket for easy installation

- LED high wattage slim flood light
- Input voltage range: 100-240V AC 50/60Hz
- Meanwell constant current driver included
- Housing: powder coated aluminium
- Diffuser: PC
- LED chips: 150pcs SMD3030 LED
- Wattage: 150W (=350W MH)
- Power factor: ≥ 0.9
- Flex & 2 pin plug: 1500mm
- Ambient temperature: -20 to 50°C
- Not suitable for dimming
- Suitable for 2-way switching

50,000hr Lifetime	120° Beam Angle	IP65 Rated	5 YEAR Replacement Warranty
-------------------	-----------------	-------------------	------------------------------------

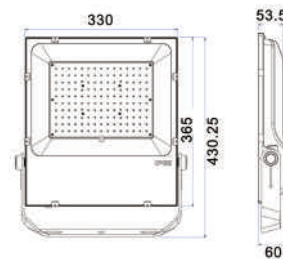

Part No.	Description	Kelvin	Lumens	Watt	CRI	Power Factor	Dimensions	Carton QTY
FLOOD22	FLOOD LED BLK 5000K 150W IP65	5000K	18000LM	150W	70	≥ 0.9	330x365x60mm	1/1

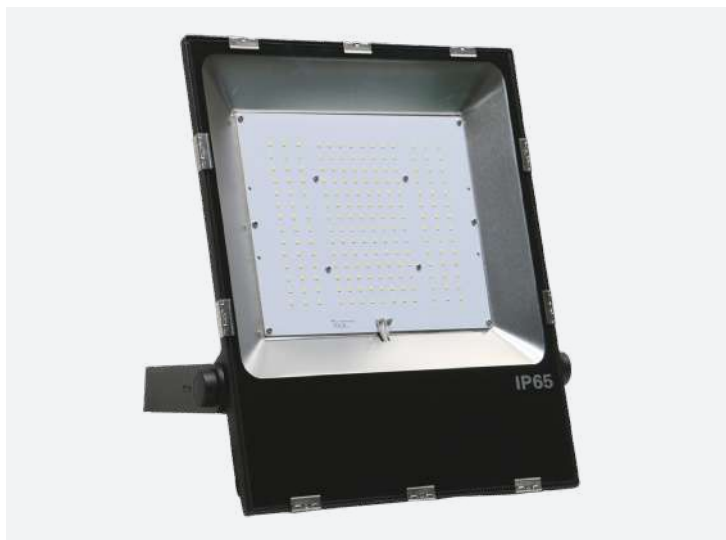

FLOOD14



Angled / offset bracket for easy installation

- LED high wattage slim flood light
- Input voltage range: 100-277V AC 50/60Hz
- Diffuser: PC
- LED chips: 224pcs SMD3030 LED
- Power factor: 0.95
- Flex & 3 pin plug: 1200mm
- Ambient temperature: -20 to 50°C
- Not suitable for dimming
- IPART & VEU approved

50,000hr Lifetime	120° Beam Angle	IP65 Rated	3 YEAR Replacement Warranty
-------------------	-----------------	-------------------	------------------------------------

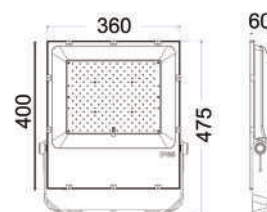

Part No.	Description	Kelvin	Lumens	Watt	CRI	Power Factor	Dimensions	Carton QTY
FLOOD14	FLOOD LED BLK 200W SMD	5000K	25000LM	200W	70	0.95	360x475x60mm	1/1

*To avoid disappointment and warranty problems, please ensure the IP Rating of the chosen product is relevant for the intended use.

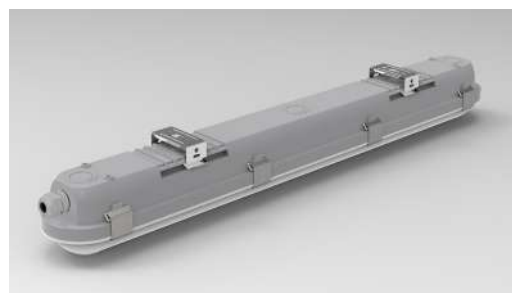

Back plate

SHIELDTRI1 & SHIELDTRI2

- Exterior LED waterproof **DUAL POWER TRI-CCT** battens
- Input voltage range: 220-240V 50Hz
- Inbuilt Constant Current LED driver
- Housing & diffuser: PC
- Tri-CCT (3000K/ 4000K/ 5000K) in one fitting
- Tri-CCT switch on internal driver
- Wattage switch inside driver
- LED chips: 120pcs or 240pcs SMD2835
- CRI: >80
- Power factor: 0.9
- Ambient temperature: -20 to 40°C
- Suitable for 2-way switching
- Suitable for use with 3 wire motion or Microwave sensors
- Includes: 2xMounting brackets(SS grade 304); 1xConnector(IP65)

30,000hr Lifetime	110° Beam Angle	IP65 Rated	IK08 Rated	3YEAR Replacement Warranty
----------------------	--------------------	----------------------	----------------------	---

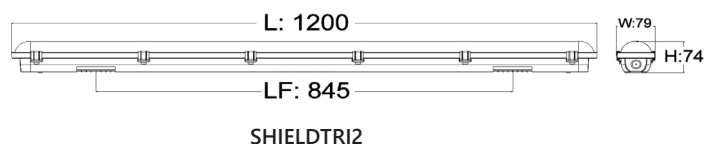

Part No.	Description	Lumens				Dimensions		Carton QTY	
		3000K		4000K		5000K			
SHIELDTRI1	BATTEN LED S/M TRIP-ROOF 9W/18W	9W	18W	9W	18W	9W	18W	600x80x75 mm	1/10
		800LM	1600LM	1000LM	2000LM	900LM	1800LM		
SHIELDTRI2	BATTEN LED S/M TRIP-ROOF 18W/36W	18W	36W	18W	36W	18W	36W	1200x80x75 mm	1/10
		1750LM	3500LM	2000LM	4000LM	1850LM	3700LM		

*To avoid disappointment and warranty problems, please ensure the IP Rating of the chosen product is relevant for the intended use.

GENERAL LIGHTING

Downlights





TELE1

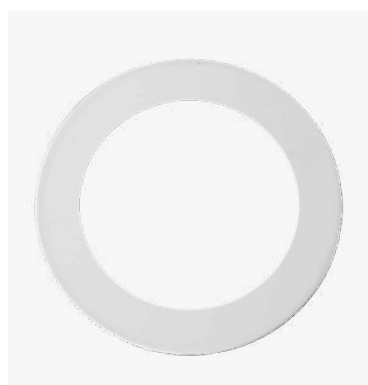

TELEPLATE1

(Convertible Plate for 90mm Cut out)

Retractable In / Out: 60mm
Swivel: 355°
Adjustable Angle: 80°

- LED recessed retractable dimmable spot downlight
- Input voltage: 220-240V AC
- External Constant Current LED driver
- Housing: Powder coated Aluminium
- Heatsink: Aluminium
- Diffuser: PC
- Tri-CCT (3000K/ 4000K/ 6000K) in one fitting
- CCT switch on driver
- LED chip: 1pc COB
- CRI: >80
- Power factor: 0.9
- Ambient temperature: -20 to 40°C
- Flex & plug: 0.6m
- Suitable for dimming
- Convertible white plate (to support TELE1 to fit 90mm cut out) is also available (sold separately)

Tested and Recommended Dimmers:

Brand	Part No.
CLA	LYNX1, VELA
CLIPSAL	32E450UDM, 31E2PUDM, 32ELEDM-WE, 32E450TM
DIGINET	MEDM, MMDM/RT
HPM	CAT250T, CAT400T

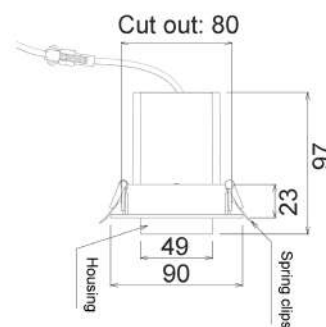

IP20
Rated

3YEAR
Replacement
Warranty

Part No.	Description	Lumens			Watt	Dimensions	Cut Out	Carton QTY
		3000K	4000K	5700K				
TELE1	D/L LED GIMBAL DIMM WH RND Tri	640LM	720LM	720LM	8W	Ø111x32.7mm	Ø90mm	1/40
TELEPLATE1	D/L Convertible plate (Support TELE1 to fit into a 90mm hole) WH OD 115mm					Ø115mm		



TUBO1



TUBO2

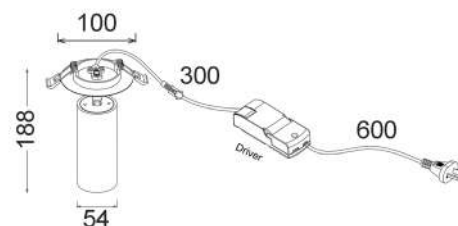

- LED recessed Tri-CCT tiltable & rotatable spot downlights
- Input voltage: 220-240V AC 50/60Hz
- External Constant Current LED driver
- Diffuser: PC
- Housing & heatsink: aluminium
- Tilt: 90° / Swivel: 355°
- LED chips: 1pc COB
- Tri-CCT (3000K/ 4000K/ 6000K) in one fitting
- CCT switch on driver
- Power factor: 0.9
- CRI: 80
- Flex & plug: 0.6m
- Ambient temperature: -20 to 40°C
- Suitable for dimming
- Suitable for 2-way switching
- Suitable for use with PIR sensor

30,000hr
Lifetime

40°
Beam Angle

IP20
Rated

DIMMABLE

3YEAR
Replacement
Warranty

Tested and Recommended Dimmers:

Brand	Part No.
CLA	LYNX1, VELA
CLIPSAL	32E450UDM, 31E2PUDM, 32ELEDM-WE, 32E450TM
DIGINET	MEDM, MMDM/RT
HPM	CAT250T, CAT400T



Part No.	Description	Lumens			Watt	Housing	Cut Out	Carton QTY
		3000K	4000K	6000K				
TUBO1	D/L Adjustable DIMM Spot WH Tri	800LM	850LM	820LM	10W	Ø54x125mm	Ø70-90mm	1/20
TUBO2	D/L Adjustable DIMM Spot BLK Tri	800LM	850LM	820LM	10W	Ø54x125mm	Ø70-90mm	1/20



SMTNOVA1

- LED SMART dimmable Tri-CCT + RGB downlight
- Input voltage range: 220-240V 50Hz
- Inbuilt constant current LED driver included
- Housing: plastic & aluminium
- Faceplate: PC
- Heatsink: aluminium
- Frosted Diffuser
- LED chips: SMD2835
- CRI: ≥80
- Power factor: ≥0.5
- Ambient temperature: -20 to 40°C
- Flex & Plug: 1m
- **App: control all functions via Tuya app on smart devices**
- **Manual: on/off control via normal wall switch**
- **Dimmable only via app or voice control through Amazon Alexa, Google Home and other compatible voice activated control devices (Not compatible with wall switch dimmer)**
- Setup requires WiFi with Internet connection
- Suitable for 2-way switching
- Not suitable for use with sensor

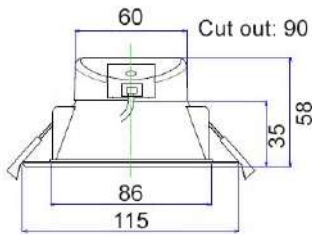

30,000hr Lifetime | 90° Beam Angle | IP44 Rated | DIMMABLE | 3 YEAR Replacement Warranty

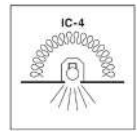

Scan QRCode to download

Additional SMART Features:

- Tuneable RGB colour spectrum (up to 14 million colours)
- Tuneable colour temperature (3000K warm white through to 6500K daylight)
- Works with any 2.4GHz enabled WiFi network (note: will not currently pair with 5.0GHz bandwidth or Bluetooth LE 4.2)
- Create schedules and timing to automate your home
- Control from anywhere via app or voice control using Alexa Hubs, Google Home and other compatible devices
- Compatible with all Tuya Powered apps

Google Assistant | amazon alexa

Part No.	Description	Kelvin	Lumens	Watt	Product Dimensions	Cut Out	Carton QTY
SMTNOVA1	D/L LED SMART WH RND DIMM TRI+RGB	RGB+ 3000-6500K	750LM - 3000K 820LM - 6500K 60LM - Red 45LM - Blue 190LM - Green	9W	Ø115x58mm	Ø90mm	1/48

Galtri Downlights - Recessed LED



GALTRI01A & GALTRI02A



- LED dimmable Tri-CCT recessed downlights
- Input voltage: 220-240V
- Remote dimmable driver included
- Housing & heatsink: plastic & aluminium
- Diffuser: frosted PC
- Faceplate: PBT
- LED chip: SMD2835
- Tri-CCT (3000K/ 4000K/ 5700K) in one fitting
- GALTRI01A-02A: CCT switch on driver
- GALTRI04-05: rear switch
- CRI: ≥ 80
- Power factor: >0.9
- Flex & plug: 600mm
- Ambient temperature: -20 to 40°C
- Suitable for dimming
- Suitable for 2-way switching
- Suitable for use with sensors

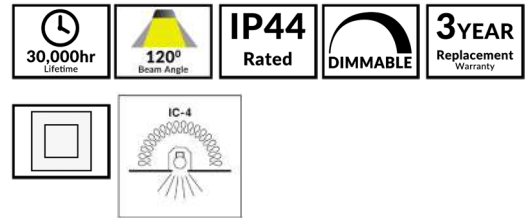

Tested & Recommended Dimmers:

Brand	Part No.
CLA	VELA
CLIPSAL	32E450TM, 32ELEDM
HPM	CAT400T
DIGINET	MEDM, MMDM/RT

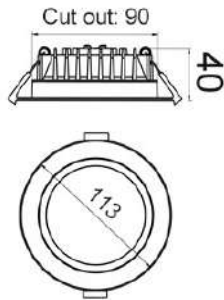

Part No.	Description	Lumens			Watt	CRI	Power Factor	Dimensions	Cut out	Carton QTY
		3000K	4000K	5700K						
GALTRI01A	D/L FIXED DIMM 10W RND WH Tri	750LM	850LM	750LM	10W	≥ 80	0.9	$\varnothing 113 \times 40 \text{mm}$	$\varnothing 90 \text{mm}$	1/40
GALTRI02A	D/L FIXED DIMM 10W RND WH Tri	900LM	1020LM	900LM	12W	≥ 80	0.9	$\varnothing 113 \times 40 \text{mm}$	$\varnothing 90 \text{mm}$	1/40



- LED dimmable Tri-CCT with changeable faceplate (via clip) recessed downlights
- Input voltage range: 220-240V 50/60Hz
- Inbuilt constant current driver included
- Housing: aluminium & plastic
- Faceplate: powder coated aluminium
- Diffuser: frosted PC
- Tri-CCT (3000K/ 4000K/ 5700K) in one fitting
- CCT switch on side
- LED chip: 24pcs SMD2835
- Power factor: 0.9
- CRI: ≥ 80
- Flex & plug: 600mm
- Ambient temperature: -20 to 40°C
- Suitable for dimming
- Suitable for 2-way switching
- Suitable for use with sensors

NOVADLUX01A Box Include:

- 1x Downlight (NOVADLUX01A) with white faceplate
- 1x Loose Satin Chrome faceplate

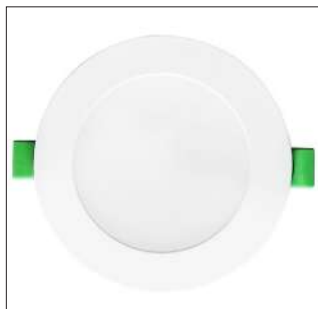

NOVADLUX01A



Satin Chrome Faceplate

30,000hr Lifetime	120° Beam Angle	IP44 Rated	DIMMABLE	3 YEAR Replacement Warranty
-------------------	-----------------	-------------------	----------	------------------------------------

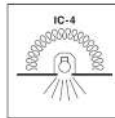

Tested & Recommended Dimmers:

Brand	Part No.
CLA	VELA
CLIPSAL	32E450TM
HPM	CAT400T
DIGINET	MEDM, MMDM/RT

Available faceplates (Sold Separately):

- Matte Black (NOVADBLK01A)
- Antique Brass (NOVADBR01A)



NOVADBR01A

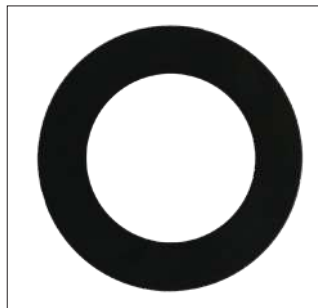

NOVADBLK01A

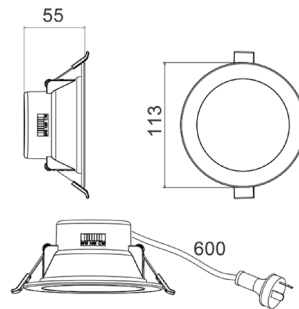

NOVADLUX01A Line Drawing

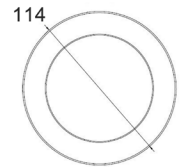

Faceplate Line Drawing

Part No.	Description	Lumens			Watt	Dimensions	Cut Out	Carton QTY
		3000K	4000K	5700K				
NOVADLUX01A	D/L LED COB FIXED WH+S/C DIMM RND TRI	800LM	950LM	850LM	10W	Ø113x55mm	Ø90mm	1/40
NOVADBLK01A	FACEPLATE TO SUIT NOVADLUX01A MATTE BLK Ø113mm							
NOVADBR01A	FACEPLATE TO SUIT NOVADLUX01A ANTIQUE BRASS Ø113mm							



- LED dimmable Tri-CCT with changeable faceplate (via clip) recessed downlights
- Input voltage range: 220-240V 50/60Hz
- Inbuilt constant current driver included
- Housing: aluminium & plastic
- Faceplate: White: plastic; Satin chrome, matte black & brass: aluminium
- Diffuser: frosted PC
- Tri-CCT (3000K/ 4000K/ 5700K) in one fitting
- CCT switch on side
- LED chip: 20pcs SMD2835
- Power factor: 0.9
- CRI: ≥ 80
- Flex & plug: 600mm
- Ambient temperature: -20 to 40°C
- Suitable for dimming
- Suitable for 2-way switching
- Suitable for use with sensors

NOVADLUX02 Box Include:

- 1x Downlight (NOVADLUX02) with white faceplate
- 1x Loose Satin Chrome (NOVADSC02) faceplate



NOVADLUX02



NOVADSC02

Tested & Recommended Dimmers:

Brand	Part No.
CLIPSAL	32E450TM
HPM	CAT400T
DIGINET	MEDM, MMDM/RT

Available faceplates (Sold Separately):

- Matte Black (NOVADBLK02)
- Antique Brass (NOVADBR02)



NOVADBR02



NOVADBLK02

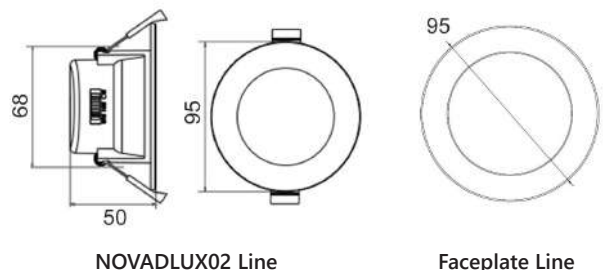

NOVADLUX02 Line

Faceplate Line

Part No.	Description	Lumens			Watt	Dimensions	Cut Out	Carton QTY
		3000K	4000K	5700K				
NOVADLUX02	D/L LED FIXED WH+S/C DIMM RND TRI	640LM	720LM	680LM	8W	Ø95x50mm	Ø70mm	1/50
NOVADBLK02	FACEPLATE TO SUIT NOVADLUX02 MATTE BLK OD 95mm							
NOVADBR02	FACEPLATE TO SUIT NOVADLUX02 ANTIQUE BRASS OD 95mm							

Comet Downlights - Recessed LED



COMET01



COMET03



COMET02



COMET04



TRI-CCT switch on rear

- LED recessed Tri-CCT dimmable centre tilt downlights
- Input voltage range: 185-265V AC 50/60Hz
- Constant current LED driver included
- Material: aluminium body & PMMA lens
- Heatsink: aluminium
- Centre tilt: 25°
- Tri-CCT (3000K/ 4200K/ 6000K) in one fitting
- LED chips: 1pc COB LED
- Power factor: ≥0.9
- Ambient temperature: -20 to 40°C
- Flex & plug: COMET01&03: 1640mm; COMET02&04: 1460mm
- Suitable for 2-way switching
- Suitable for dimming
- Suitable for 3 wire motion/ microwave sensors

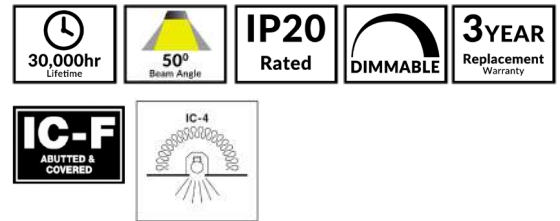

Tested & Recommended Dimmers:

Brand	Part No.
Diginet	MEDM & MMDM/RT
CLIPSAL	32ELEDM-WE, 32E450TM, 32E450LM, 32E450UDM & 31E2PUDM
HPM	CAT250L, CAT250T & CAT400T

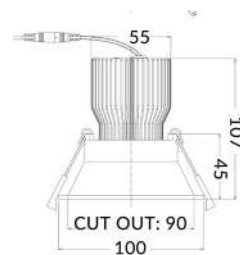

COMET01 & 03

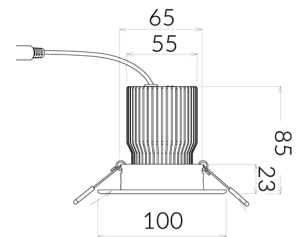

COMET02 & 04

Part No.	Description	Lumens			Watt	CRI	Diam	Depth	Cut Out	Carton QTY
		3000K	4200K	6000K						
COMET01	D/L LED DIMM C/TILT MATTE BL RND LOW GLARE Tri	750LM	850LM	800LM	10W	80	Ø100mm	107mm	Ø90mm	1/24
COMET02	D/L LED DIMM C/TILT MATTE Brushed Nickel Tri	800LM	900LM	850LM	10W	80	Ø100mm	85mm	Ø70-90mm	1/24
COMET03	D/L LED DIMM C/TILT MATTE WH RND LOW GLARE Tri	750LM	850LM	800LM	10W	80	Ø100mm	107mm	Ø90mm	1/24
COMET04	D/L LED DIMM C/TILT WH RND Tri	800LM	900LM	850LM	10W	80	Ø100mm	85mm	Ø70-90mm	1/24



COMET05
(Fixed)



COMET06
(Fixed)



COMET07
(Gimbal Tilt: 30°)



COMET08
(Gimbal Tilt: 30°)

- LED dimmable low glare Tri-CCT downlights
- Input voltage: 220-240V AC
- Inbuilt constant current LED driver included
- Housing & heatsink: plastic & aluminium
- Diffuser: PC
- Tri-CCT (3000K/ 4000K/ 6000K) in one fitting
- Rear switch
- CRI: ≥80
- Power factor: 0.9
- Flex & plug: 1m
- Ambient temperature: -20 to 40°C
- Suitable for dimming
- Suitable for 2-way switching
- COMET05-06: IP20 (IP54 for front face only)
- COMET07-08: IP20

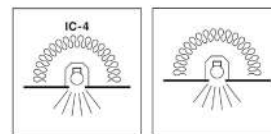

COMET05-06 COMET07-08

Tested & Recommended Dimmers:

Brand	Part No.
CLA	VELA
CLIPSAL	32E450UDM, 31E2PUDM, 32ELEDM-WE, 32E450TM
HPM	CAT250T, CAT400T
DIGINET	MEDM

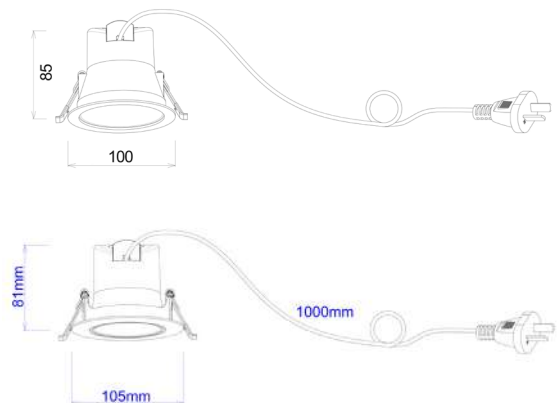

Part No.	Description	Lumens			Watt	Dimensions	Cut Out	Carton QTY
		3000K	4000K	6000K				
COMET05	D/L LED FIXED DIMM BLK RND Low Glare COB TRI	700LM	800LM	750LM	9W	Ø100x85mm	Ø85-90mm	1/45
COMET06	D/L LED FIXED DIMM WH RND Low Glare COB TRI	700LM	800LM	750LM	9W	Ø100x85mm	Ø85-90mm	1/45
COMET07	D/L LED GIMBAL DIMM BLK RND Low Glare COB TRI	700LM	800LM	750LM	9W	Ø105x85mm	Ø90mm	1/45
COMET08	D/L LED GIMBAL DIMM WH RND Low Glare COB TRI	700LM	800LM	750LM	9W	Ø105x85mm	Ø90mm	1/45



COSMOTRI03-05

- Input voltage: 220-240V AC 50/60Hz
- External constant current LED driver included
- Housing & heatsink: plastic & aluminium
- Diffuser: Opal PC
- Faceplate: PBT
- Power factor: 0.9
- Tri-CCT (3000K/ 4000K/ 5700K) in one fitting
- CCT switch on driver
- LED chips: SMD2835
- CRI: ≥ 80
- Flex & plug: 600mm
- Ambient temperature: -20 to 40°C
- Suitable for dimming
- Suitable for 2-way switching
- Suitable for use with sensor

30,000hr
Lifetime

110°
Beam Angle

IP20
Rated

DIMMABLE

3YEAR
Replacement
Warranty

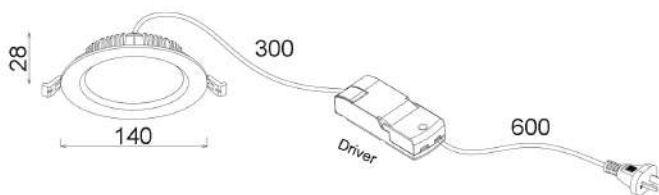
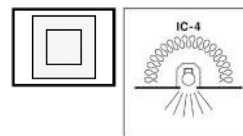

COSMOTRI03

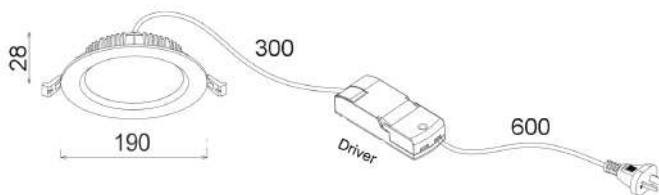

COSMOTRI04

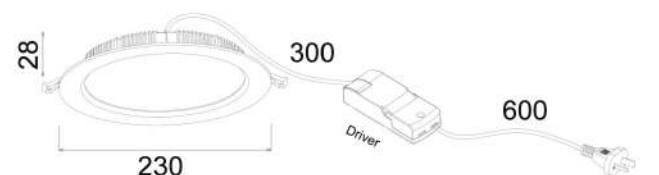

COSMOTRI05

Tested & Recommended Dimmers:

Brand	Part No.
CLA	VELA
CLIPSAL	32E450UDM, 31E2PUDM, 32ELEDM-WE, 32E450TM,
HPM	CAT250T, CAT400T
DIGINET	MEDM, MMDM/RT

GENERAL LIGHTING

Part No.	Lumens			Watt	CRI	Power Factor	Dimensions	Cut out	Carton QTY
	3000K	4000K	5700K						
COSMOTRI03	1200LM	1350LM	1250LM	15W	≥ 80	0.9	Ø140x28mm	Ø110-120mm	1/30
COSMOTRI04	1800LM	2000LM	1900LM	20W	≥ 80	0.9	Ø190x28mm	Ø155-170mm	1/20
COSMOTRI05	2250LM	2500LM	2375LM	25W	≥ 80	0.9	Ø230x28mm	Ø195-210mm	1/20

Firefly Downlights - Recessed LED



FIREFLY01A

- LED gimbal white dimmable Tri-CCT recessed downlights
- Input voltage: 220-240V
- External Constant Current LED driver included
- Degree of tilt: 20°
- Housing & heatsink: plastic & aluminium
- Diffuser: clear PC
- Faceplate: plastic
- LED chip: 1pc COB
- Tri-CCT changeable: 3000K/ 4000K/ 5700K
- Rear switch
- CRI: >80
- Power factor: >0.9
- Flex & plug: 0.6m
- Ambient temperature: -20 to 40°C
- Suitable for dimming
- Suitable for 2-way switching
- Suitable for use with PIR & Microwave sensors



CENTRE TILT: 20°



REAR CCT SWITCH

30,000hr Lifetime	60° Beam Angle	IP20 Rated	DIMMABLE	3YEAR Replacement Warranty	
----------------------	-------------------	----------------------	----------	---	--

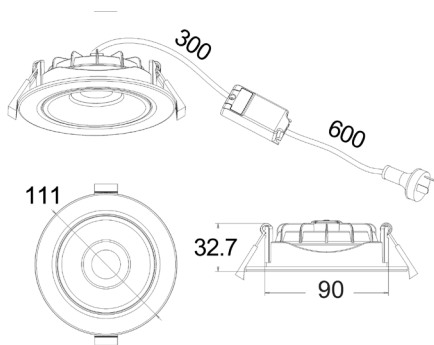
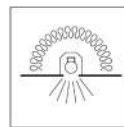

Tested & recommended dimmers:

Brand	Part No.
CLA	VELA
CLIPSAL	32E450TM, 32ELEDM
HPM	CAT400T
DIGINET	MEDM, MMDM/RT

Part No.	Description	Lumens			Watt	Dimensions	Cut Out	Carton QTY
		3000K	4000K	5700K				
FIREFLY01A	D/L LED GIMBAL DIMM WH RND Tri	640LM	720LM	720LM	8W	Ø111X32.7mm	Ø90mm	1/40



NOVATRIS

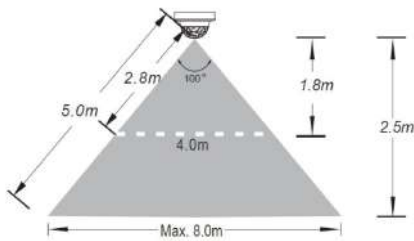

Recommended Height of Installation: 1.8-2.5m
 Detection Distance: Max. 8m
 Height: 1.8M = 4 meter detection range
 Height: 2.5M = 8 meter detection range
 *Note: The detection distance will vary with change of installation height

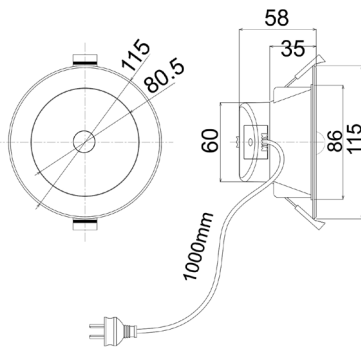

- LED Tri-CCT motion sensor downlight
- Input voltage: 220-240V 50Hz
- Inbuilt constant current driver included
- Housing & heatsink: plastic & aluminium
- LED chips: SMD2835
- Tri-CCT (3000K/ 4000K/ 5000K) in one fitting
- Rear switch
- Power factor: 0.9
- CRI: ≥ 80
- Flex & plug: 1.0m
- Ambient temperature: -20 to 40°C
- Not suitable for dimming
- Suitable for 2-way switching

Sensor Technical Spec:

- Sensor type: PIR
- Wattage / power consumption: <0.5W
- Installation height: 1.8-2.5m
- Detection angle: 360°
- Motion detection speed: 1.5m/s
- Time delay: 70 ± 10s
- UV resistant: Yes
- Manual override: No

30,000hr
Lifetime

100°
Beam Angle

IP44
Rated

3YEAR
Replacement
Warranty

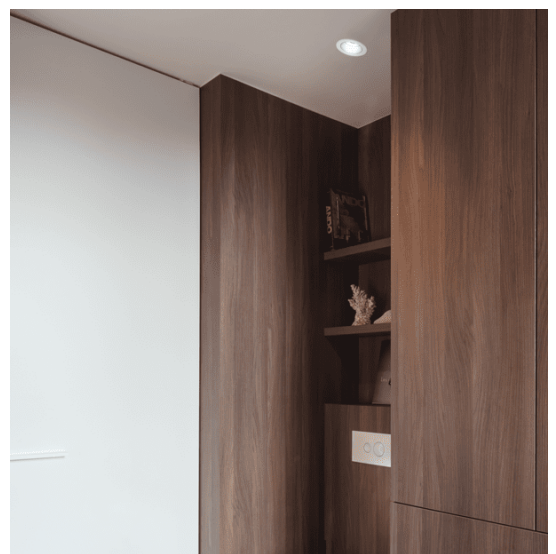
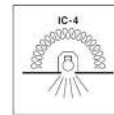

Part No.	Description	Lumens			Watt	CRI	Dimensions	Cut out	Carton QTY
		3000K	4000K	5000K					
NOVATRIS	D/L LED FIXED DIMM MOTION SENSOR WH RND TRI	750LM	850LM	800LM	9W	80	Ø115x58mm	Ø90mm	1/48

Motion Downlights - Recessed LED



MOTION1-4

- LED recessed motion sensor downlights
- Input voltage range: 180-260V AC 50/60Hz
- Constant current LED driver included
- Material: aluminium & PC
- LED chips: SMD2835 LED
- Power factor: >0.5
- CRI: >80

Sensor Technical Spec:

- Sensor type: PIR
- Max.detection diameter radius: 5m
- Sensor time delay: 90 seconds
- Detection range: 80°
- Block time: 0.2 seconds
- Flex & plug: 1200mm
- Ambient temperature: -20 to 45°C
- Not suitable for dimming
- Suitable for 2-way switching
- Sensor operates Day and Night (No Manual Override)

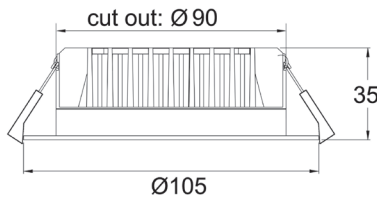

MOTION1 & 3

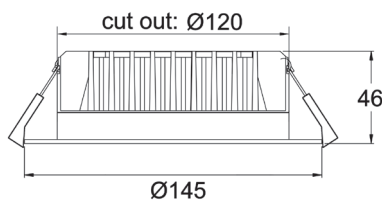

MOTION2 & 4

Applications:

Great design. Suitable for hallway, laundry room, living room and most indoor locations.

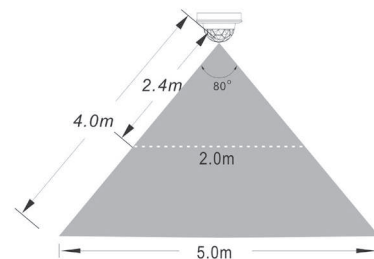

Part No.	Kelvin	Lumens	LED Chips	Watt	CRI	Diam	Depth	Cut Out	Carton QTY
MOTION1	3000K	800LM	24pcs 2835	10W	>80	Ø105mm	35mm	Ø90mm	1/36
MOTION2	3000K	1200LM	36pcs 2835	15W	>80	Ø145mm	46mm	Ø120mm	1/24
MOTION3	5000K	850LM	24pcs 2835	10W	>80	Ø105mm	35mm	Ø90mm	1/36
MOTION4	5000K	1250LM	36pcs 2835	15W	>80	Ø145mm	46mm	Ø120mm	1/24



SLICKTRI1-3R
(Round)



SLICKTRI1-3S
(Square)

- LED dimmable ultra slim Tri-CCT recessed downlights
- Input voltage range: 220-240V
- Remote constant current driver included
- Housing & faceplate: PC
- Diffuser: white PS
- Tri-CCT (3000K/ 4000K/ 5000K) in one fitting
- CCT switch on DC cable
- LED chips: SMD2835
- Power factor: 0.9
- CRI: >80
- Flex & plug: 1.2m
- Ambient temperature: -20 to 40°C
- Suitable for dimming
- Suitable for 2-way switching
- Suitable for use with Microwave/ motion sensor
- Recommended usage: 8-10 hours/day
- The driver should NOT BE covered with thermal insulation

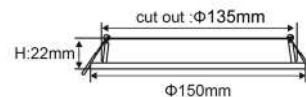

SLICKTRI1R

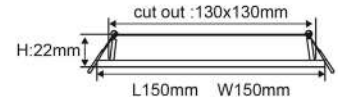

SLICKTRI1S

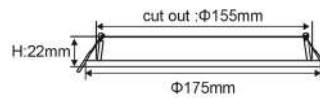

SLICKTRI2R

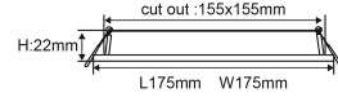

SLICKTRI2S



SLICKTRI3R

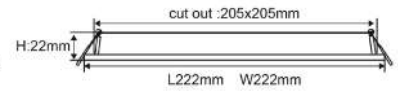

SLICKTRI3S

Tested & Recommended Dimmers:

Brand	Part No.
CLA	VELA
CLIPSAL	32E450UDM, 31E2PUDM, 32ELEDDWE, 32E450TM, PDL354PBDMUN-VW
HPM	Cat 250T, Cat 400T
DIGINET	MEDM, MMDM/RT



Part No.	Shape	Lumens			Watt	Dimensions	Driver Size	Switch Size	Carton QTY
		3000K	4000K	5000K					
SLICKTRI1R	Round	630LM	720LM	680LM	9W	Ø150x22mm	80x31x20mm	45x23x15mm	1/40
SLICKTRI2R	Round	840LM	960LM	900LM	12W	Ø175x22mm	87x37x20mm	45x23x15mm	1/40
SLICKTRI3R	Round	1350LM	1550LM	1450LM	18W	Ø222x22mm	87x37x20mm	45x23x15mm	1/20
SLICKTRI1S	Square	630LM	720LM	680LM	9W	150x150x22mm	80x31x20mm	45x23x15mm	1/40
SLICKTRI2S	Square	840LM	960LM	900LM	12W	175x175x22mm	87x37x20mm	45x23x15mm	1/40
SLICKTRI3S	Square	1350LM	1550LM	1450LM	18W	222x222x22mm	87x37x20mm	45x23x15mm	1/20

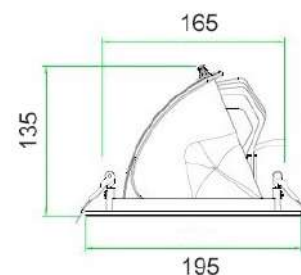

SHOPTRI01
(Power switch & CCT switch on rear)

- LED gimabl white recessed shop lighter downlight
- 6 fittings in 1: Dual power & Tri-CCT changeable
- Input voltage: 220-240V AC 50/60Hz
- Remote Constant Current driver included
- Degree of tilt: 50°
- Housing & heatsink: aluminium
- Diffuser: Textured clear glass
- Faceplate: powder coated aluminium
- Dual power: 28W/ 38W
- Tri-CCT (3000K/ 4000K/ 5700K) in one fitting
- Rear switches
- Power factor: 0.94
- LED chips: SMD2835
- CRI: ≥ 80
- Flex & plug: 1500mm
- Ambient temperature: -20 to 40°C
- Not suitable for dimming
- Suitable for use with PIR/ Microwave sensors

30,000hr
Lifetime

90°
Beam Angle

IP20
Rated

3YEAR
Replacement
Warranty

Part No.	Lumens						Dimensions	Cut Out	Carton QTY
	3000K		4000K		5700K				
	28W	38W	28W	38W	28W	38W			
SHOPTRI01	2426LM	3270LM	2800LM	3800LM	2460LM	3300LM	Ø195X135mm	Ø165mm	1/12

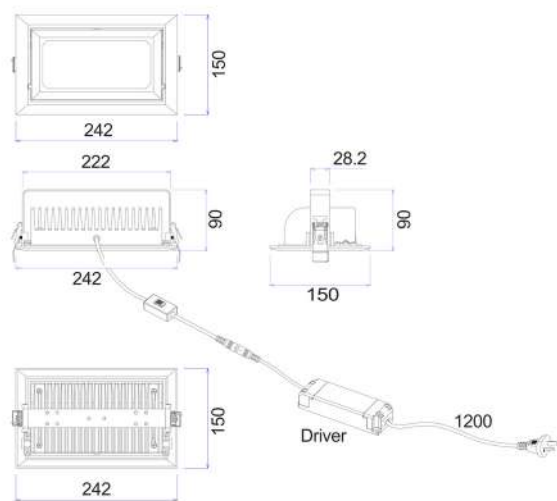

SHOPTRI
(CCT switch on DC cable)

- LED gimbal dimmable Tri-CCT rectangular shop lighter
- Input voltage: 200-240V AC 50/60Hz
- External constant current dimmable driver included
- Housing: white powder coated aluminium
- Textured clear glass diffuser
- Mounting plate & heatsink: aluminium
- Surface mounted or recessed
- Adjustable: 90°
- Tri-CCT (3000K / 4000K / 5700K) switch on DC cable
- LED chips: SMD2835
- Power factor: 0.95
- CRI: ≥ 80
- Flex & plug: 1200mm
- Ambient temperature: -20 to 40°C
- Mounting bracket: L 222mm x W 28.2mm
- Suitable for dimming
- Suitable for 2 way switching
- Suitable for use with PIR/ Microwave sensors

Tested & Recommended Dimmers:

Brand	Part No.
CLIPSAL	32ELEDM, 32E450UDM, 31E2PUDM
HPM	CAT250, CAT250T, CAT400T
DIGINET	MMDM/RT, MEDM

30,000hr
Lifetime

120°
Beam Angle

IP20
Rated

DIMMABLE

3YEAR
Replacement
Warranty

Part No.	Description	Lumens			Watt	Power Factor	Dimensions	Cut Out	Carton QTY
		3000K	4000K	5700K					
SHOPTRI	D/L LED SHOP GIMBAL DIMM WH RECT 35W TRI	2900LM	3200LM	3000LM	35W	0.95	242x150x-90mm	230x130mm	1/6

Surface (LED) Downlights - Surface Mounted

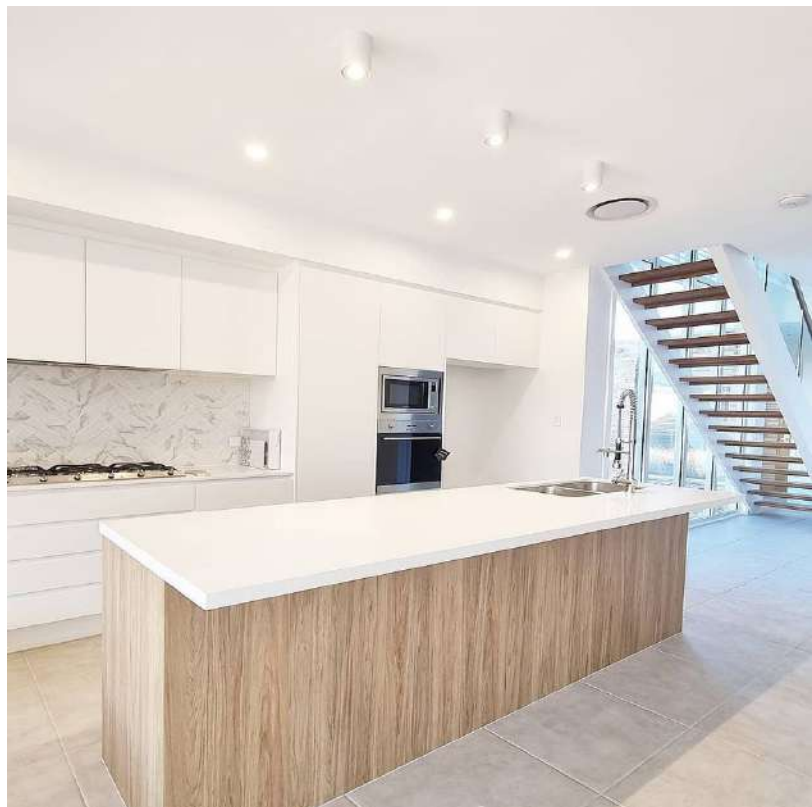

SURFACE13-14

- LED surface mounted ceiling downlights
- Input voltage range: 220-240V AC 50/60Hz
- Constant current LED driver included
- Housing & heat sink: aluminium
- Bracket: aluminium
- LED chips: 1pc COB
- Power factor: ≥ 0.9
- CRI: ≥ 80
- Ambient temperature: -20 to 40°C
- 150mm 3 core cable without plug
- Suitable for dimming
- Recommended Universal trailing edge & leading edge dimmers
- Suitable for 2-way switching
- Suitable for use with PIR sensors



35,000hr Lifetime	40° Beam Angle	IP65 Rated	DIMMABLE	3YEAR Replacement Warranty
-------------------	----------------	------------	----------	----------------------------

Tested & Recommended Dimmers:

Brand	Part No.
HPM	CAT250L, CAT250T, CAT400T
CLIPSAL	32ELEDM, 31E2PUDM, 32E450UDM, 32E450LM

Part No.	Description	Kelvin	Lumens	Watt	CRI	Barrell	Carton QTY
SURFACE13	D/L DIMM LED S/M WHITE GLOSS RND	3000K	800LM	13W	≥ 80	Ø105x146mm	1/12
SURFACE14	D/L DIMM LED S/M WHITE GLOSS RND	5000K	900LM	13W	≥ 80	Ø105x146mm	1/12

Surface (GU10) Downlights - Surface Mounted



SURFACE17A



SURFACE18A



SURFACE22



SURFACE23

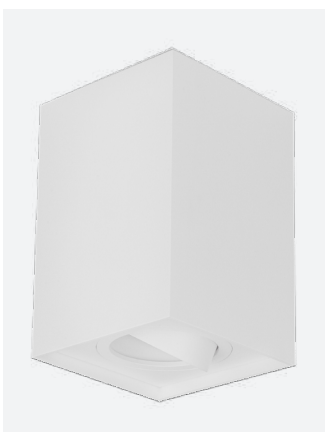

SURFACE24



SURFACE25



- GU10 surface mounted downlights
- Input voltage range: 220-240V
- Housing: powder coated aluminium
- Mounting plate: aluminium
- Fitting colours: matte black and matte white
- SURFACE22-25: 15° tilt/ adjustable
- Lamp holder: GU10 (Max.50W)
- Globe not included
- Flex & plug not included

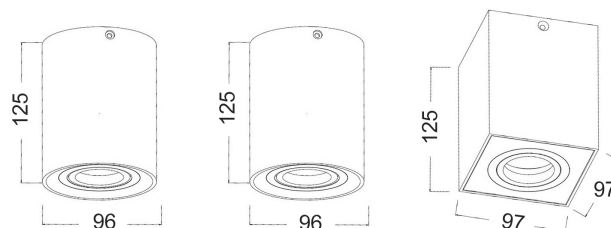

Part No.	Description	Lamp Holder	Max. Wattage	Barrell	Carton QTY
SURFACE17A	D/L GU10 (Max 50W) S/M Matte WH RND	GU10	50W	Ø96x125mm	1/30
SURFACE18A	D/L GU10 (Max 50W) S/M Matte BLK RND	GU10	50W	Ø96x125mm	1/30
SURFACE22	D/L GU10 (Max 50W) S/M Gimbal Matte WH RND	GU10	50W	Ø96x125mm	1/20
SURFACE23	D/L GU10 (Max 50W) S/M Gimbal Matte BLK RND	GU10	50W	Ø96x125mm	1/20
SURFACE24	D/L GU10 (Max 50W) S/M Gimbal Matte WH SQ	GU10	50W	97x97x125mm	1/20
SURFACE25	D/L GU10 (Max 50W) S/M Gimbal Matte BLK SQ	GU10	50W	97x97x125mm	1/20



GENERAL LIGHTING

Spot Lights

Spot Spot Lights



SPOT-R1B



SPOT-S1B

- Input voltage: 100-240V AC 50/60Hz
- Housing: powder coated aluminium
- Mounting plate: iron
- 180° Tilt / 328° swivel
- Lamp holder: GU10 (Max.50W)
- Globe not included
- Globe grabber/ suction cap included



SPOT-R3B



SPOT-BAR2B

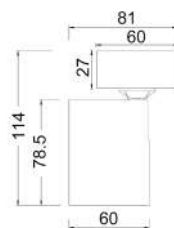

SPOT-R1B

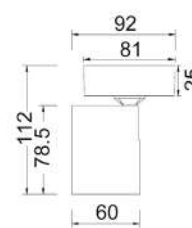

SPOT-S1B



SPOT-BAR3B

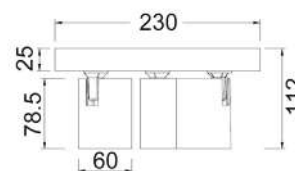

SPOT-R3B



SPOT-BAR4B

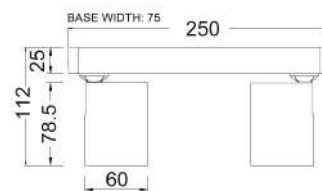

SPOT-BAR2B

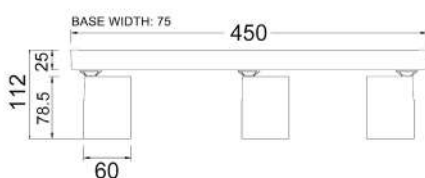

SPOT-BAR3B

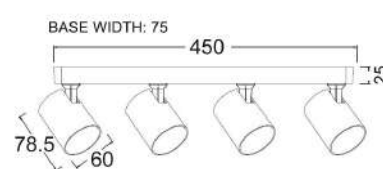

SPOT-BAR4B



SPOT-R1W



SPOT-S1W



SPOT-R3W



SPOT-BAR2W



SPOT-BAR3W



SPOT-BAR4W

Part No.	Description	Base	Carton QTY
SPOT-S1B	SPOT GU10 1 LIGHT/ADJ SQ BASE BLK	L81xW81xH25mm	1/50
SPOT-R1B	SPOT GU10 1 LIGHT/ADJ RND BASE BLK	Ø60xH27mm	1/50
SPOT-R3B	SPOT GU10 3 LIGHT/ADJ RND BASE BLK	Ø230xH25mm	1/8
SPOT-BAR2B	SPOT GU10 2 LIGHT/ADJ BAR BLK	L250xW75xH25mm	1/12
SPOT-BAR3B	SPOT GU10 3 LIGHT/ADJ BAR BLK	L450xW75xH25mm	1/8
SPOT-BAR4B	SPOT GU10 4 LIGHT/ADJ BAR BLK	L450xW75xH25mm	1/8
SPOT-S1W	SPOT GU10 1 LIGHT/ADJ SQ BASE WH	L81xW81xH25mm	1/50
SPOT-R1W	SPOT GU10 1 LIGHT/ADJ RND BASE WH	Ø60xH27mm	1/50
SPOT-R3W	SPOT GU10 3 LIGHT/ADJ RND BASE WH	Ø230xH25mm	1/8
SPOT-BAR2W	SPOT GU10 2 LIGHT/ADJ BAR WH	L250xW75xH25mm	1/12
SPOT-BAR3W	SPOT GU10 3 LIGHT/ADJ BAR WH	L450xW75x25mm	1/8
SPOT-BAR4W	SPOT GU10 4 LIGHT/ADJ BAR WH	L450xW75xH25mm	1/8

Tache Spot Lights



TACHE1
(3XGU10)



TACHE2
(4XGU10)



TACHE3
(6XGU10)

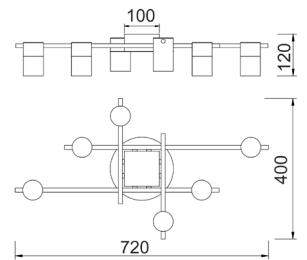
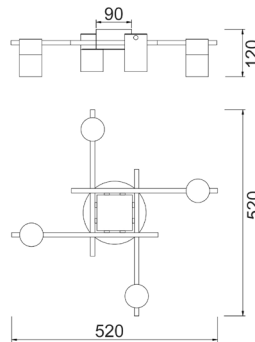
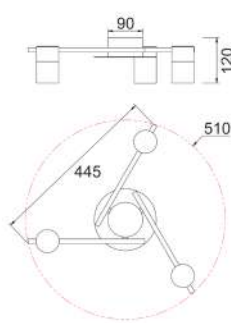

- Interior spot ceiling lights
- Material: aluminium
- Globe not included
- For indoor use only
- Warning: Adjustable head but Maximum 15° either way. Adjusting more than the suggested angle will cause damage to the fitting



Part No.	TACHE1-3
Description	SPOT GU10 Interior Ceiling Lamp Adj Ant/Brs Head w/Brs Rnd Base
Material	Aluminium
Lamp holder	TACHE1: 3 x GU10 (Max.35W) TACHE2: 4 x GU10 (Max.35W) TACHE3: 6 x GU10 (Max.35W)
Dimensions	TACHE1: Ø510 x H120mm TACHE2: 520 x 520 x H120mm TACHE3: 720 x 400 x H120mm
Base	TACHE1-2: Ø160mm TACHE3: Ø180mm
Canopy	TACHE1: Ø90 x H45mm TACHE2: Ø90 x H45mm TACHE3: Ø100 x H45mm
Carton QTY	1/1





TACHE4
(3XGU10)



TACHE5
(4XGU10)



TACHE6
(6XGU10)

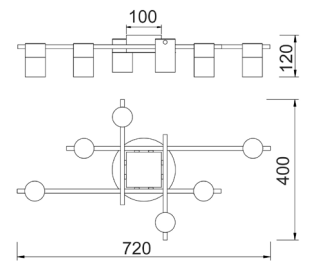
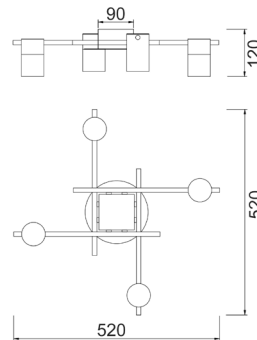
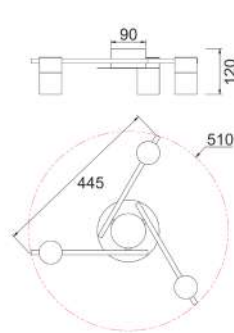

- Interior spot ceiling lights
- Material: aluminium
- Globe not included
- For indoor use only
- Warning: Adjustable head but Maximum 15° either way. Adjusting more than the suggested angle will cause damage to the fitting



Part No.	TACHE4-6
Description	SPOT GU10 Interior Ceiling Lamp Adj Blk & Ant/Brs Head w/Brs Rnd Base
Material	Aluminium
Lamp holder	TACHE4: 3 x GU10 (Max.35W) TACHE5: 4 x GU10 (Max.35W) TACHE6: 6 x GU10 (Max.35W)
Dimensions	TACHE4: Ø510 x H120mm TACHE5: 520 x 520 x H120mm TACHE6: 720 x 400 x H120mm
Base	TACHE4-5: Ø160mm TACHE6: Ø180mm
Canopy	TACHE4: Ø90 x H45mm TACHE5: Ø90 x H45mm TACHE6: Ø100 x H45mm
Carton QTY	1/1





TACHE7
(3XGU10)



TACHE8
(4XGU10)



TACHE9
(6XGU10)

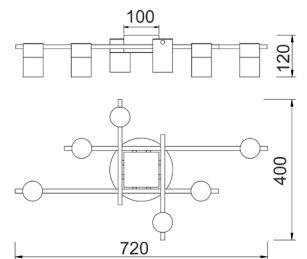
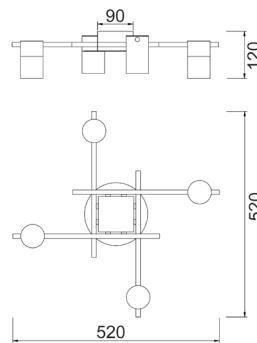
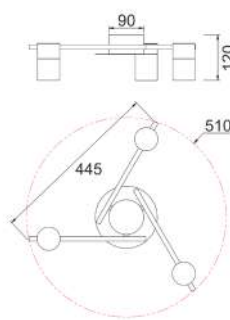

- Interior spot ceiling lights
- Material: aluminium
- Globe not included
- For indoor use only
- Warning: Adjustable head but Maximum 15° either way. Adjusting more than the suggested angle will cause damage to the fitting



Part No.	TACHE7-9
Description	SPOT GU10 Interior Ceiling Lamp Adj Chrome Head w/Chrome Rnd Base
Material	Aluminium
Lamp holder	TACHE7: 3 x GU10 (Max.35W) TACHE8: 4 x GU10 (Max.35W) TACHE9: 6 x GU10 (Max.35W)
Dimensions	TACHE7: Ø510 x H120mm TACHE8: 520 x 520 x H120mm TACHE9: 720 x 400 x H120mm
Base	TACHE7-8: Ø160mm TACHE9: Ø180mm
Canopy	TACHE7: Ø90 x H45mm TACHE8: Ø90 x H45mm TACHE9: Ø100 x H45mm
Carton QTY	1/1





TACHE10
(3XGU10)



TACHE11
(4XGU10)



TACHE12
(6XGU10)

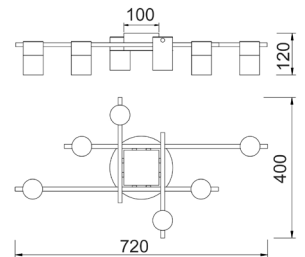
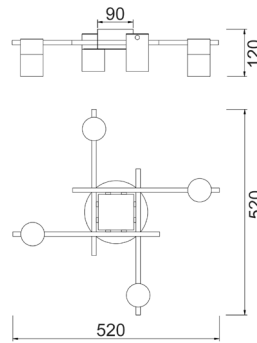
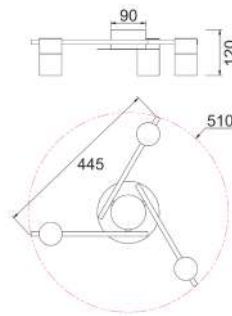

- Interior spot ceiling lights
- Material: aluminium
- Globe not included
- For indoor use only
- Warning: Adjustable head but Maximum 15° either way. Adjusting more than the suggested angle will cause damage to the fitting



Part No.	TACHE10-12
Description	SPOT GU10 Interior Ceiling Lamp Adj Black Head w/Black Rnd Base
Material	Aluminium
Lamp holder	TACHE10: 3 x GU10 (Max.35W) TACHE11: 4 x GU10 (Max.35W) TACHE12: 6 x GU10 (Max.35W)
Dimensions	TACHE10: Ø510 x H120mm TACHE11: 520 x 520 x H120mm TACHE12: 720 x 400 x H120mm
Base	TACHE10-11: Ø160mm TACHE12: Ø180mm
Canopy	TACHE10: Ø90 x H45mm TACHE11: Ø90 x H45mm TACHE12: Ø100 x H45mm
Carton QTY	1/1





TACHE13
(3XGU10)

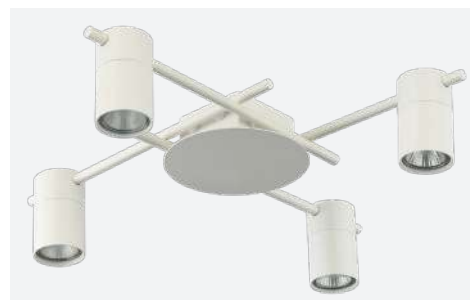

TACHE14
(4XGU10)



TACHE15
(6XGU10)

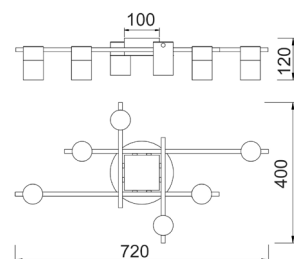
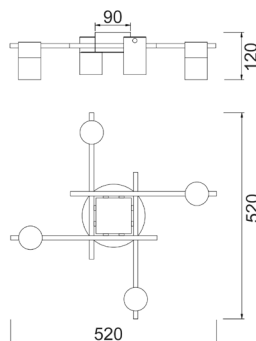
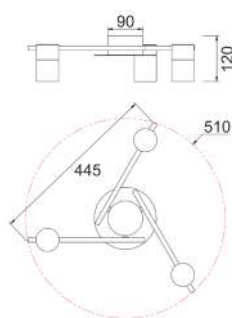

- Interior spot ceiling lights
- Material: aluminium
- Globe not included
- For indoor use only
- Warning: Adjustable head but Maximum 15° either way. Adjusting more than the suggested angle will cause damage to the fitting



Part No.	TACHE13-15
Description	SPOT GU10 Interior Ceiling Lamp Adj White Head w/white Rnd Base
Material	Aluminium
Lamp holder	TACHE13: 3 x GU10 (Max.35W) TACHE14: 4 x GU10 (Max.35W) TACHE15: 6 x GU10 (Max.35W)
Dimensions	TACHE13: Ø510 x H120mm TACHE14: 520 x 520 x H120mm TACHE15: 720 x 400 x H120mm
Base	TACHE13-14: Ø160mm TACHE15: Ø180mm
Canopy	TACHE13: Ø90 x H45mm TACHE14: Ø90 x H45mm TACHE15: Ø100 x H45mm
Carton QTY	1/1





GENERAL LIGHTING

Oyster Lights



SMTOYS1

- LED smart Tri-CCT dimmable oyster light
- Input voltage range: 220-240V 50Hz
- Inbuilt constant current LED driver included
- Housing: powder coated iron
- Mounting plate: iron
- Heatsink: iron & aluminium
- Diffuser: PMMA
- LED chips: SMD2835
- CRI: ≥ 80
- Power factor: ≥ 0.9
- Ambient temperature: -20 to 40°C
- App: control all functions via Tuya app on smart devices
- Manual: on/off control via normal wall switch
- Dimmable only via app or voice control through Amazon Alexa, Google Home and other compatible voice activated control devices (Not compatible with wall switch dimmer)
- Setup requires WiFi with Internet connection
- Suitable for 2-way switching
- Not suitable for use with sensor

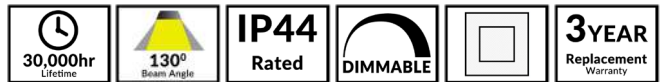

Additional SMART Features:

- Tuneable colour temperature (3000K warm white through to 6500K daylight)
- Works with any 2.4GHz enabled WiFi network(note: will not currently pair with 5.0GHz bandwidth.) or Bluetooth LE 4.2
- Create schedules and timing to automate your home
- Control from anywhere via app or voice control using Alexa Hubs, Google Home and other compatible devices
- Compatible with all Tuya Powered apps



Scan QRCode to download

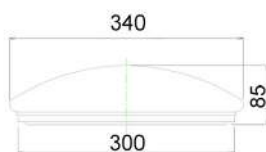

Part No.	Description	Kelvin	Lumens	Watt	Dimensions	Base	Carton QTY
SMTOYS1	OYSTER LED SMART WH RND DIMM TRI CCT	3000-6500K	1350-1550LM	18W	Ø340x85mm	Ø300mm	1/8



OYSDIM001-002

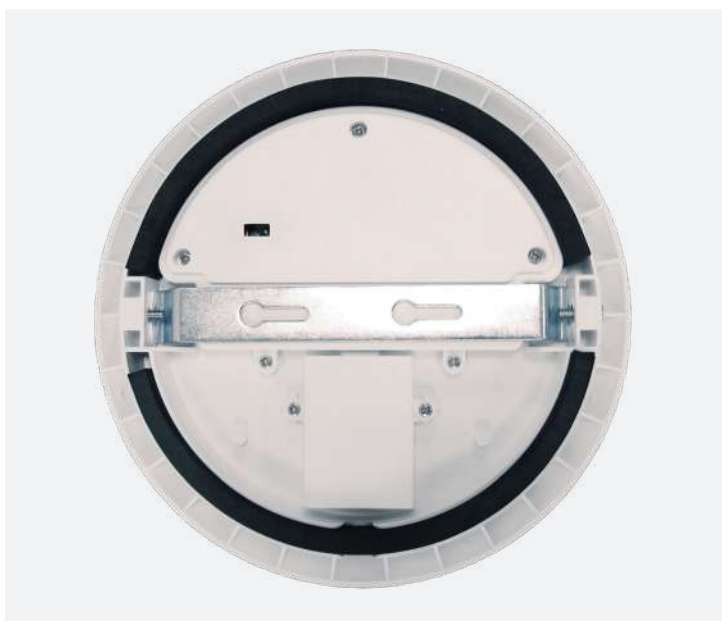

Back plate

- LED Tri-CCT dimmable oyster lights
- Input voltage range: 200-240V AC 50/60Hz
- Inbuilt driver output voltage: 60-80V
- Material: PC
- LED chips: SMD2835
- Power factor: >0.9
- Tri-CCT (3000K/ 4000K/ 5000K) in one fitting
- CRI: 80
- Ambient temperature: -20 to 40°C
- Suitable for dimming
- Suitable for 2-way switching
- Suitable for use with PIR or microwave sensors
- Suitable for indoor & outdoor use
- Changes to appearance due to climatic conditions not covered under warranty



Tested & Recommended Dimmers:

Brand	Part No.
HPM	CAT250L
CLIPSAL	32ELEDM, 31E2PUDM, 32E450T, 31E450UDM

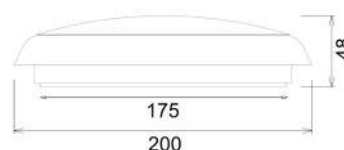

OYSDIM001

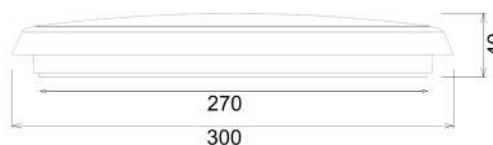

OYSDIM002

Part No.	Lumens			Watt	CRI	Power Factor	Diam	Depth	Back Plate	Carton QTY
	3000K	4000K	5000K							
OYSDIM001	1200LM	1300LM	1250LM	15W	80	>0.9	Ø200mm	48mm	Ø175mm	1/20
OYSDIM002	2000LM	2200LM	2100LM	24W	80	>0.9	Ø300mm	40mm	Ø270mm	1/12



OYSDIM003-005

- LED Tri-CCT dimmable oyster lights
- Input voltage range: 220-240V AC 50/60Hz
- Constant current inbuilt driver output voltage: 60-80VDC
- Base: metal
- Diffuser: PS
- LED chips: SMD2835 LED
- Power factor: >0.9
- Tri-CCT (3000K/ 4000K/5000K) in one fitting
- CRI: 80
- Ambient temperature: -20 to 40°C
- Suitable for dimming
- Suitable for 2-way switching
- Suitable for use with 3 wire motion or microwave sensors
- Changes to appearance due to climatic conditions not covered under warranty



Tested & Recommended Dimmers:

Brand	Part No.
HPM	CAT250L, CAT250T & CAT400T
CLIPSAL	32E450UDM, 31E2PUDM, 32E450LM, 32ELEDM-WE & 32E450TM
DIGINET	MEDM, MMDM/RT
HPM	CAT250L

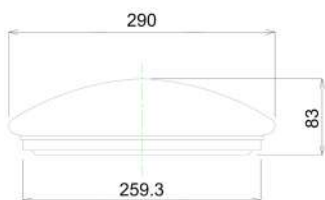

OYSDIM003

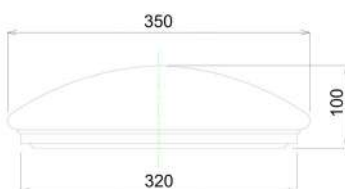

OYSDIM004

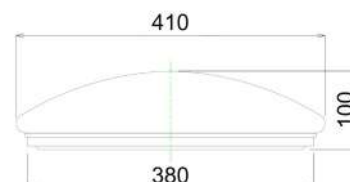

OYSDIM005

Part No.	Lumens			Watt	CRI	Power Factor	Diam	Depth	Back Plate	Carton QTY
	3000K	4000K	5000K							
OYSDIM003	960LM	1140LM	1020LM	12W	80	>0.9	Ø290mm	83mm	Ø259.3mm	1/10
OYSDIM004	1400LM	1650LM	1500LM	18W	80	>0.9	Ø350mm	100mm	Ø320mm	1/10
OYSDIM005	1700LM	2000LM	1800LM	24W	80	>0.9	Ø410mm	100mm	Ø380mm	1/8





SURFACETRI1-3R



SURFACETRI1-3S

- LED dimmable surface mounted oyster lights
- Input voltage range: 220-240V
- Inbuilt constant current driver included
- Housing & faceplate: PC
- Diffuser: white PS
- Mounting bracket: aluminium
- Tri-CCT (3000K/ 4000K/ 5000K) in one fitting
- CCT switch on DC cable
- LED chips: SMD2835
- Power factor: 0.9
- CRI: ≥ 80
- Flex & plug not included
- Ambient temperature: -20 to 40°C
- Suitable for dimming
- Suitable for 2-way switching
- Suitable for use with motion or Microwave sensors

 30,000hr Lifetime	 110° Beam Angle	 IP40 Rated	 DIMMABLE		 3YEAR Replacement Warranty
--	---	---	--	---	--

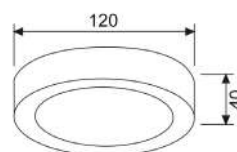

SURFACETRI1R

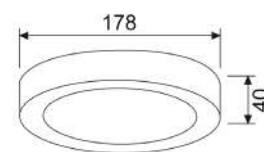

SURFACETRI2R

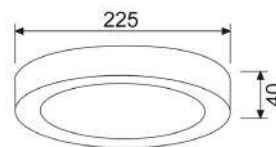

SURFACETRI3R

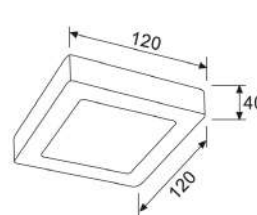

SURFACETRI1S

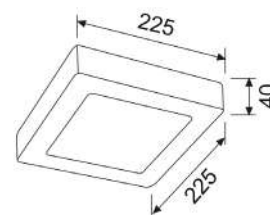

SURFACETRI3S

Tested & Recommended Dimmers:

BRAND	PART NO.
CLA	VELA
CLIPSAL	32E450UDM, 31E2PUDM, 32ELEDDM-WE, 32E450TM, PDL354PBDMUN-VW
HPM	Cat 250T, Cat 400T
Diginet	MEDM, MMDM/RT

Part No.	Description	Lumens			Watt	CRI	Carton QTY
		3000K	4000K	5000K			
SURFACETRI1R	OYSTER DIMM LED S/M WH RND TRI	420LM	480LM	450LM	6W	≥ 80	1/40
SURFACETRI2R	OYSTER DIMM LED S/M WH RND TRI	840LM	960LM	900LM	12W	≥ 80	1/40
SURFACETRI3R	OYSTER DIMM LED S/M WH RND TRI	1350LM	1550LM	1450LM	18W	≥ 80	1/20
SURFACETRI1S	OYSTER DIMM LED S/M WH SQ TRI	420LM	480LM	450LM	6W	≥ 80	1/40
SURFACETRI3S	OYSTER DIMM LED S/M WH SQ TRI	1350LM	1550LM	1450LM	18W	≥ 80	1/20

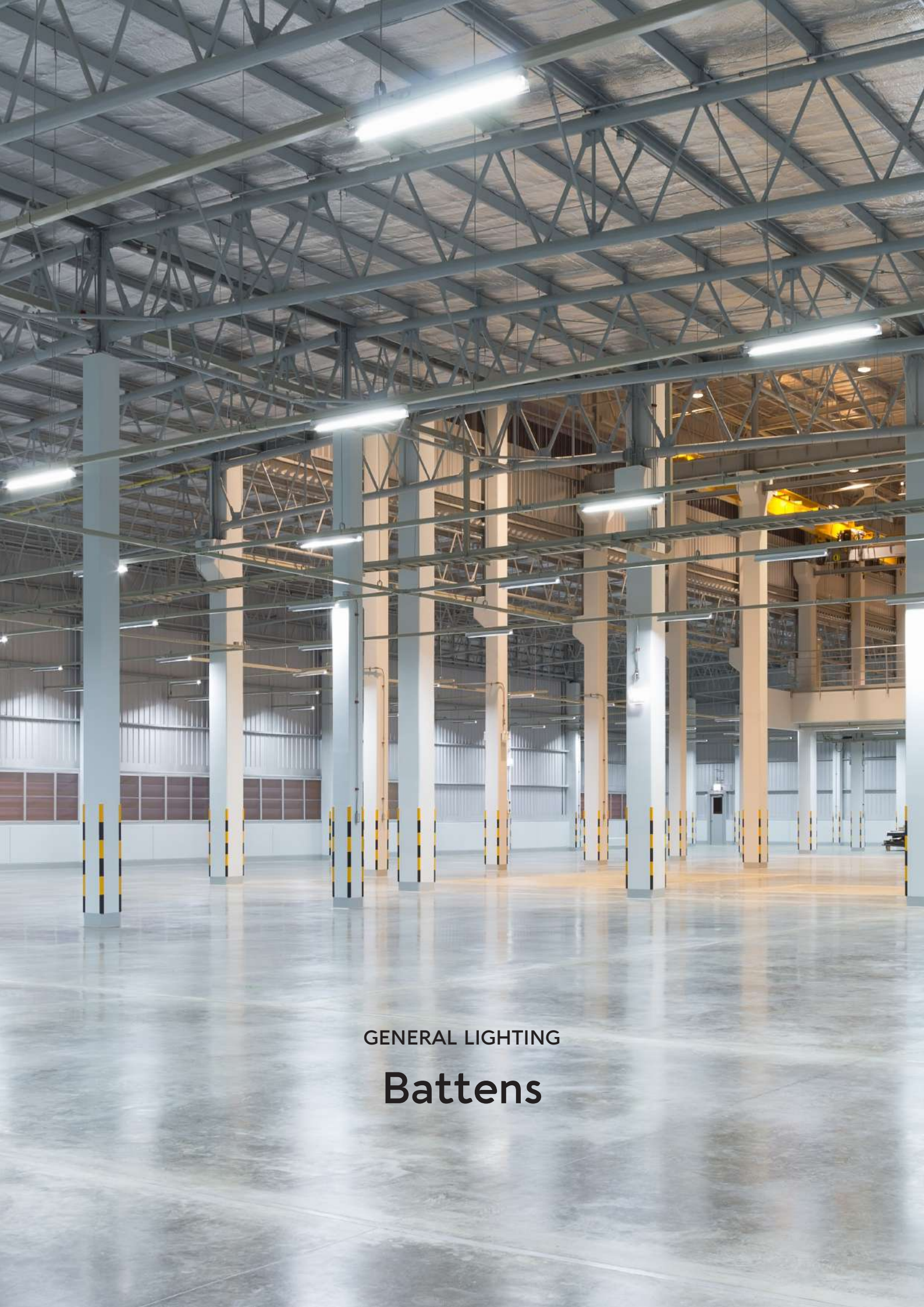

GENERAL LIGHTING

Battens



Back plate

BAT001-002

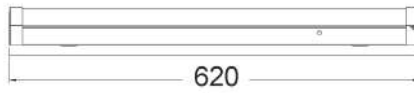

BAT001

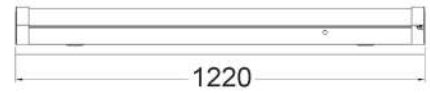

BAT002

- LED Tri-CCT dimmable oyster lights
- Input voltage: 220-240V
- Driver inbuilt
- Material: steel & PC
- Tri-CCT (3000K/ 4000K/ 5700K) in one fitting
- CCT switch inside the fitting
- Power factor: 0.9
- Ambient temperature: -20 to 40°C
- Not suitable for dimming
- Suitable for 2-way switching
- Suitable for use with 3 wire sensor
- **Large terminal block for easy installation**

30,000hr Lifetime	110° Beam Angle	IP20 Rated	3YEAR Replacement Warranty
----------------------	--------------------	----------------------	---

Part No.	Description	Lumens				Dimensions	Carton QTY
		3000K		4000K			
BAT001	BATTEN LED S/M 10W/20W Tri L620mm	10W	20W	10W	20W	620x65x70 mm	1/9
		900LM	1800LM	1100LM	2200LM		
BAT002	BATTEN LED S/M 20W/40W Tri L1220mm	20W	40W	20W	40W	1220x65x70 mm	1/9
		1800LM	3600LM	2200LM	4400LM		



RAZORDM001A-002A
(Central hole in mounting plate)



RAZORDM001A



RAZORDM002A

- Interior LED dimmable Tri-CCT surface mounted batterns
- Input voltage range: 220-240V AC 50/60Hz
- Constant current inbuilt driver included
- Housing: powder coated aluminium
- Diffuser: PC
- Heat sink: aluminium
- Tri-CCT (3000K/ 4000K/ 5000K) in one fitting
- LED chips: SMD2835
- Power factor: ≥ 0.9
- CRI: >80
- Ambient temperature: -20 to 40°C
- Suitable for dimming
- Suitable for 2-way switching
- Suitable for use with 3 wire motion or Microwave sensors

Tested & Recommended Dimmers:

Brand	Part No.
DIGINET	LEDsMart: MMDM/BP, MMDM/RT
Clipsal	Universal: 32ELEDM, 32E450UDM
HPM	CAT400L, CAT400T

30,000hr
Lifetime

110°
Beam Angle

IP20
Rated

DIMMABLE

3YEAR
Replacement
Warranty

Part No.	Lumens			LED Chips	Watt	CRI	Length	Width	Depth	Carton QTY
	3000K	4000K	5000K							
RAZORDM001A	1500LM	1700LM	1500LM	240pcs 2835	18W	>80	600mm	75mm	31mm	1/10
RAZORDM002A	3000LM	3400LM	3000LM	480pcs 2835	36W	>80	1200mm	75mm	31mm	1/10

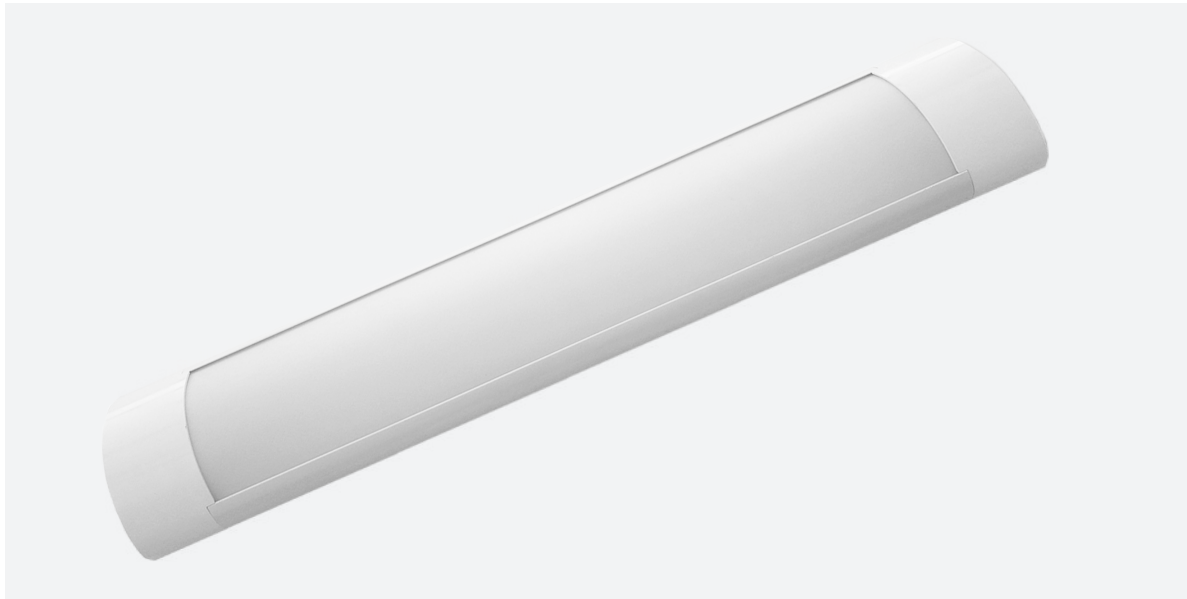

RAZORDMW001-002
(Wide Housing: 120mm; Central hole in mounting plate)

- Interior LED Surface Mounted Dimmable Tri-CCT Batters (Wide)
- Input voltage: 220-240V AC 50/60Hz
- Inbuilt driver included
- Diffuser: PC (white)
- Housing: powder coated aluminium
- Heatsink: aluminium
- High power factor: ≥ 0.9
- Tri-CCT (3000K/ 4000K/ 5000K) in one fitting
- Internal switch (under diffuser)
- Central hole in mounting plate
- LED chips: SMD2835
- CRI: >80
- Ambient temperature: -20 to 40°C
- Suitable for dimming with most trailing edge dimmers
- Suitable for 2-way switching
- Suitable for use with 3 wire Microwave & Motion sensors

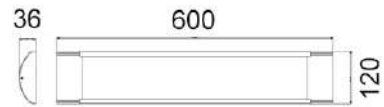

RAZORDMW001

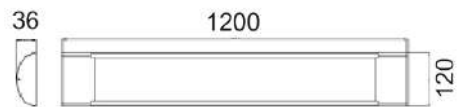

RAZORDMW002



30,000hr
Lifetime



110°
Beam Angle

IP20
Rated



DIMMABLE

3YEAR
Replacement
Warranty

Tested & Recommended Dimmers:

Brand	Part No.
CLIPSAL	32E450TM, 32E450UDM 32ELEDM 400W 41E300PBUD2SM-VM
HPM	Cat 400L, Cat400T, MMDM/BP400W, MMDM(RT)400W

Part No.	Description	Lumens			Watt	CRI	Power Factor	Dimensions	Carton QTY
		3000K	4000K	5000K					
RAZORDMW01	BATTEN LED S/M WH DIMM Central Hole 1700Lm TRI	1500LM	1700LM	1500LM	18W	>80	≥ 0.9	600x120mm	1/10
RAZORDMW02	BATTEN LED S/M WH DIMM Central Hole 3400Lm TRI	3000LM	3400LM	3000LM	36W	>80	≥ 0.9	1200x120mm	1/10



Back plate

SHIELDTRI1 & SHIELDTRI2

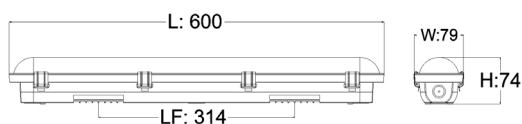

SHIELDTRI1

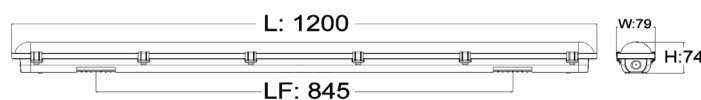

SHIELDTRI2

- Exterior LED waterproof **DUAL POWER TRI-CCT** battens
- Input voltage range: 220-240V 50Hz
- Inbuilt Constant Current LED driver
- Housing & diffuser: PC
- Tri-CCT (3000K/ 4000K/ 5000K) in one fitting
- Tri-CCT switch on internal driver
- Wattage switch inside driver
- LED chips: 120pcs or 240pcs SMD2835
- CRI: >80
- Power factor: 0.9
- Ambient temperature: -20 to 40°C
- Suitable for 2-way switching
- Suitable for use with 3 wire motion or Microwave sensors
- Includes: 2xMounting brackets(SS grade 304); 1xConnector(IP65)

30,000hr Lifetime	110° Beam Angle	IP65 Rated	IK08 Rated	3YEAR Replacement Warranty
----------------------	--------------------	----------------------	----------------------	---

Part No.	Description	Lumens				Dimensions		Carton QTY	
		3000K		4000K		5000K			
SHIELDTRI1	BATTEN LED S/M TRIP-ROOF 9W/18W	9W	18W	9W	18W	9W	18W	600x80x75 mm	1/10
		800LM	1600LM	1000LM	2000LM	900LM	1800LM		
SHIELDTRI2	BATTEN LED S/M TRIP-ROOF 18W/36W	18W	36W	18W	36W	18W	36W	1200x80x75 mm	1/10
		1750LM	3500LM	2000LM	4000LM	1850LM	3700LM		



GENERAL LIGHTING

Connectable Track Systems

LED Track Heads Connectable Track Systems



TRKTRI01
(Black)



TRKTRI02
(White)



Additional 60° lens is included in the package Rear Switch

- 4 wire 3 circuit LED track light heads
- Input voltage: 220-240V
- Faceplate & housing: PC
- Diffuser: PMMA
- Heatsink: aluminium
- Tri-CCT: 2700K/ 4000K/ 6000K in one fitting
- LED chip: 1pc COB LED
- Rear switch
- Power factor: 0.9
- CRI: ≥ 90
- Tilt: 90° / Swivel: 355°
- Ambient temperature: -20 to 40°C
- Suitable for dimming
- Suitable for 2-way switching

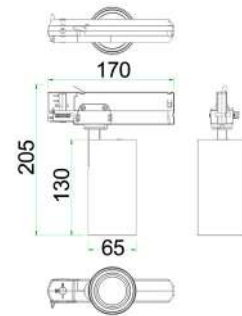

Tested & Recommended Dimmers:

Brand	Part No.
CLA	VELA
CLIPSAL	32ELEDM, 32E450UDM
DIGINET	MEDM
HPM LEGRAND	EM400TRWE

Part No.	Description	Lumens			Watt	CRI	Carton QTY
		2700K	4000K	6000K			
TRKTRI01	TRACK 4 WIRE 3 Circuit LED HEAD BLK	1120lm	1260lm	1220lm	15W	≥ 90	1/16
TRKTRI02	TRACK 4 WIRE 3 Circuit LED HEAD WH	1250lm	1420lm	1370lm	15W	≥ 90	1/16



TRKTRI03
(Black)



TRKTRI04
(White)



Additional 60° lens is included in the package Rear Switch

- 3 wire 1 circuit LED track light heads
- Input voltage: 220-240V
- Faceplate & housing: PC
- Diffuser: PMMA
- Heatsink: aluminium
- Tri-CCT: 2700K/ 4000K/ 6000K in one fitting
- LED chip: 1pc COB LED
- Rear switch
- Power factor: 0.9
- CRI: ≥ 90
- Tilt: 90° / Swivel: 355°
- Ambient temperature: -20 to 40°C
- Suitable for dimming
- Suitable for 2-way switching

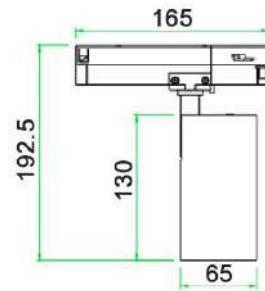

Tested & Recommended Dimmers:

Brand	Part No.
CLA	VELA
CLIPSAL	32ELEDM, 32E450UDM
DIGINET	MEDM
HPM LEGRAND	EM400TRWE

Part No.	Description	Lumens			Watt	CRI	Carton QTY
		2700K	4000K	6000K			
TRKTRI03	TRACK 3 WIRE 1 Circuit LED HEAD BLK	1120lm	1260lm	1220lm	15W	≥ 90	1/16
TRKTRI04	TRACK 3 WIRE 1 Circuit LED HEAD WH	1250lm	1420lm	1370lm	15W	≥ 90	1/16

GU10 Track Heads Connectable Track Systems



TRKB3G002 & TRKB1G002



TRKW3G002 & TRKW1G002

- Interior GU10 universal track head lights
- Suitable for universal track
- Input voltage range: 100-240V
- Material: aluminium
- Colour: black and white
- Lamp holder: 1xGU10 (Max.50W)
- Globe not included
- Tilt: 90° / Swivel: 328°
- **Globe grabber/suction cap included**

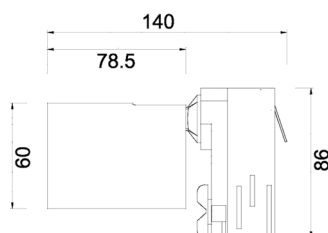

TRKB3G002 & TRKW3G002

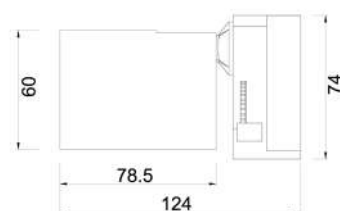

TRKB1G002 & TRKW1G002

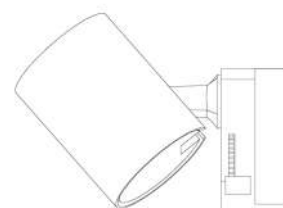
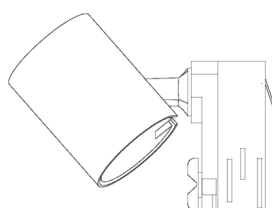

4 WIRE 3 CIRCUIT TRACK HEAD LIGHTS:

Part No.	Description	Carton QTY
TRKB3G002	TRACK Head 4 WIRE 3 Circuit GU10 BLK (No Globes) (Suitable for Universal Track)	1/50
TRKW3G002	TRACK Head 4 WIRE 3 Circuit GU10 WH (No Globes) (Suitable for Universal Track)	1/50

3 WIRE 1 CIRCUIT TRACK HEAD LIGHTS:

Part No.	Description	Carton QTY
TRKB1G002	TRACK Head 1 Circuit GU10 BLK (No Globes) IP20 (Suitable for Universal Track)	1/50
TRKW1G002	TRACK Head 1 Circuit GU10 WH (No Globes) IP20 (Suitable for Universal Track)	1/50

4 Wire 3 Circuit Tracks & Accessories Connectable Track Systems

4 Wire 3-Circuit Track

- Input voltage range: 220-240V/ 16A
- Material: PC and aluminium
- Colour: black and white
- Universal track



TRK3BL1M
TRK3BL2M

TRK3WH1M
TRK3WH2M

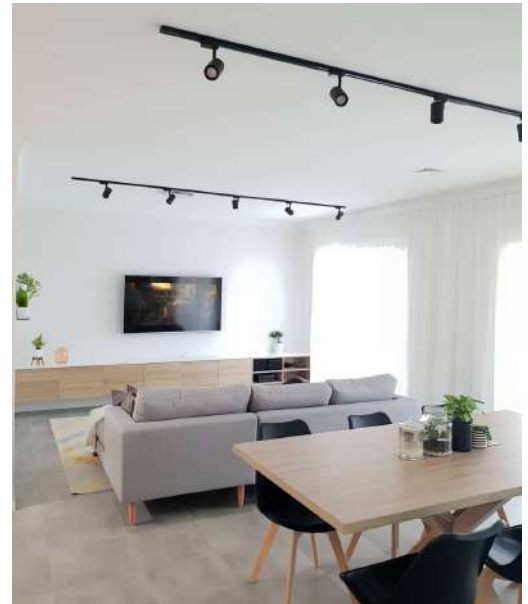

Part No.	Description	Dimensions	Carton QTY
TRK3BL1M	TRACK 3 Circuit 4 Wire 1M BLK (incl LIVE TRK3BLLIVER & END CAP TRK3BLEND)	L1000xW35.2xH35.51mm	1/12
TRK3BL2M	TRACK 3 Circuit 4 Wire 2M BLK (incl LIVE TRK3BLLIVER & END CAP TRK3BLEND)	L2000xW35.2xH35.51mm	1/12
TRK3WH1M	TRACK 3 Circuit 4 Wire 1M WH (incl LIVE TRK3WHLIVER & END CAP TRK3WHEND)	L1000xW35.2xH35.51mm	1/12
TRK3WH2M	TRACK 3 Circuit 4 Wire 2M WH (incl LIVE TRK3WHLIVER & END CAP TRK3WHEND)	L2000xW35.2xH35.51mm	1/12

4 Wire 3-Circuit Track Straight Connectors



TRK3BLCON1

TRK3WHCON1

TRK3BLCON2

TRK3WHCON2

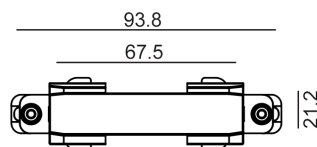

TRK3BLCON1
TRK3WHCON1

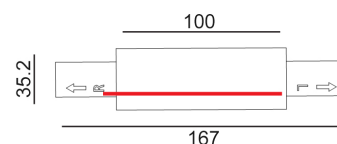

TRK3BLCON2
TRK3WHCON2

Part No.	Description	Carton QTY
TRK3BLCON1	TRACK 3 Circuit 4 Wire Mini Straight Connector BLK	1/100
TRK3BLCON2	TRACK 3 Circuit 4 Wire Straight Connector BLK	1/100
TRK3WHCON1	TRACK 3 Circuit 4 Wire Mini Straight Connector WH	1/100
TRK3WHCON2	TRACK 3 Circuit 4 Wire Straight Connector WH	1/100

4 Wire 3-Circuit Track 'L-Piece' Connectors (Left or right)



TRK3BLCON3R
TRK3BLCON3L



TRK3WHCON3R
TRK3WHCON3L

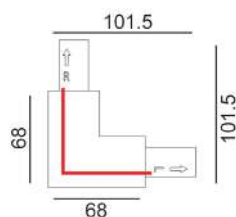

TRK3BLCON3L
TRK3WHCON3L

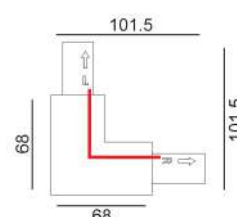

TRK3BLCON3R
TRK3WHCON3R

Part No.	Description	Carton QTY
TRK3BLCON3L	TRACK 3 Circuit 4 Wire L-Piece Connector - LEFT BLK	1/30
TRK3BLCON3R	TRACK 3 Circuit 4 Wire L-Piece Connector - RIGHT BLK	1/30
TRK3WHCON3L	TRACK 3 Circuit 4 Wire L-Piece Connector - LEFT WH	1/30
TRK3WHCON3R	TRACK 3 Circuit 4 Wire L-Piece Connector - RIGHT WH	1/30

4 Wire 3-Circuit Track 'T-Piece' Connectors (Left or right)



TRK3BLCON4L1
TRK3BLCON4L2
TRK3BLCON4R1
TRK3BLCON4R2



TRK3WHCON4L1
TRK3WHCON4L2
TRK3WHCON4R1
TRK3WHCON4R2

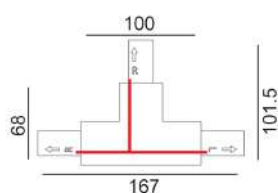

TRK3BLCON4L1
TRK3WHCON4L1

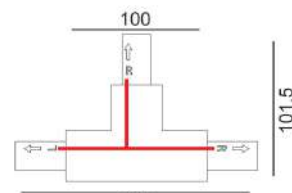

TRK3BLCON4L2
TRK3WHCON4L2

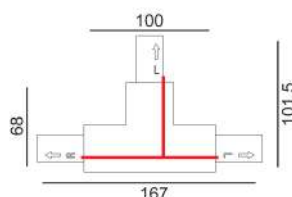

TRK3BLCON4R1
TRK3WHCON4R1

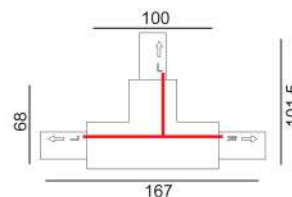

TRK3BLCON4R2
TRK3WHCON4R2

Part No.	Description	Carton QTY
TRK3BLCON4L1	TRACK 3 Circuit 4 Wire T-Piece Connector - LEFT1 BLK	1/30
TRK3BLCON4L2	TRACK 3 Circuit 4 Wire T-Piece Connector - LEFT2 BLK	1/30
TRK3BLCON4R1	TRACK 3 Circuit 4 Wire T-Piece Connector - RIGHT1 BLK	1/30
TRK3BLCON4R2	TRACK 3 Circuit 4 Wire T-Piece Connector - RIGHT2 BLK	1/30
TRK3WHCON4L1	TRACK 3 Circuit 4 Wire T-Piece Connector - LEFT1 WH	1/30
TRK3WHCON4L2	TRACK 3 Circuit 4 Wire T-Piece Connector - LEFT2 WH	1/30
TRK3WHCON4R1	TRACK 3 Circuit 4 Wire T-Piece Connector - RIGHT1 WH	1/30
TRK3WHCON4R2	TRACK 3 Circuit 4 Wire T-Piece Connector - RIGHT2 WH	1/30

4 Wire 3-Circuit Track 'Cross-Piece' & Elbow Connectors



TRK3BLCON5



TRK3WHCON5



TRK3BLCON6



TRK3WHCON6

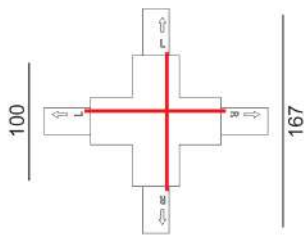

TRK3BLCON5
TRK3WHCON5

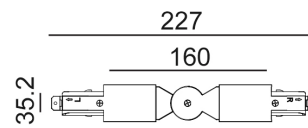

TRK3BLCON6
TRK3WHCON6

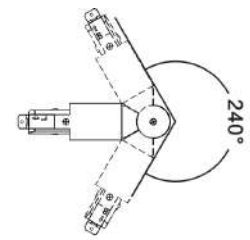

Part No.	Description	Carton QTY
TRK3BLCON5	TRACK 3 Circuit 4 Wire Cross-Piece Connector BLK	1/30
TRK3BLCON6	TRACK 3 Circuit 4 Wire Elbow Connector BLK	1/30
TRK3WHCON5	TRACK 3 Circuit 4 Wire Cross-Piece Connector WH	1/30
TRK3WHCON6	TRACK 3 Circuit 4 Wire Elbow Connector WH	1/30

4 Wire 3-Circuit Track Flexible Connector



TRK3BLFLEXCON



TRK3WHFLEXCON

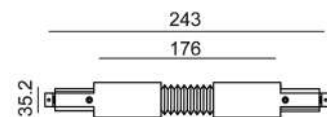

Part No.	Description	Carton QTY
TRK3BLFLEXCON	TRACK 3 Circuit 4 Wire Flexible Connector BLK	1/1
TRK3WHFLEXCON	TRACK 3 Circuit 4 Wire Flexible Connector WH	1/1

***NOTE:** Except TRK3BL/WHCON1 & TRK3BL/WHCON6, all our connectors and joiners have center feed facility (ability to connect with power supply)

4 Wire 3-Circuit Track End Cap & Live End (Left or right)

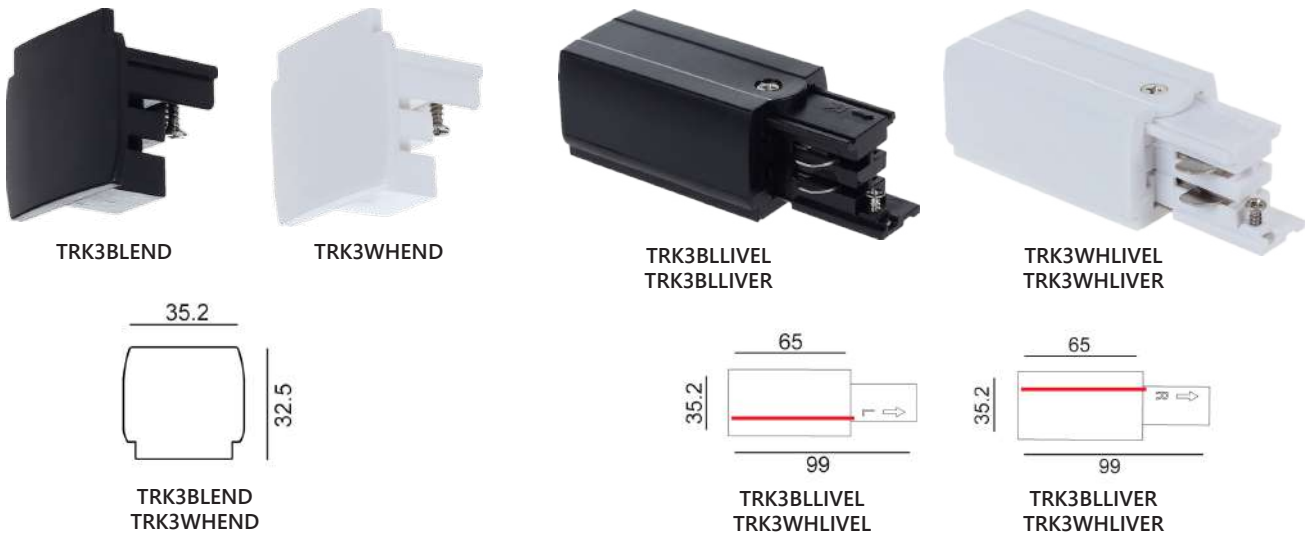

Part No.	Description	Carton QTY
TRK3BLEND	TRACK 3 Circuit 4 Wire End Cap BLK	1/100
TRK3BLLLEVEL	TRACK 3 Circuit 4 Wire TRACK LIVE END - LEFT BLK	1/100
TRK3BLLIVER	TRACK 3 Circuit 4 Wire TRACK LIVE END - RIGHT BLK	1/100
TRK3WHEND	TRACK 3 Circuit 4 Wire End Cap WH	1/100
TRK3WHLLEVEL	TRACK 3 Circuit 4 Wire TRACK LIVE END - LEFT WH	1/100
TRK3WHLIVER	TRACK 3 Circuit 4 Wire TRACK LIVE END - RIGHT WH	1/100

4 Wire 3-Circuit Track Ceiling Kits

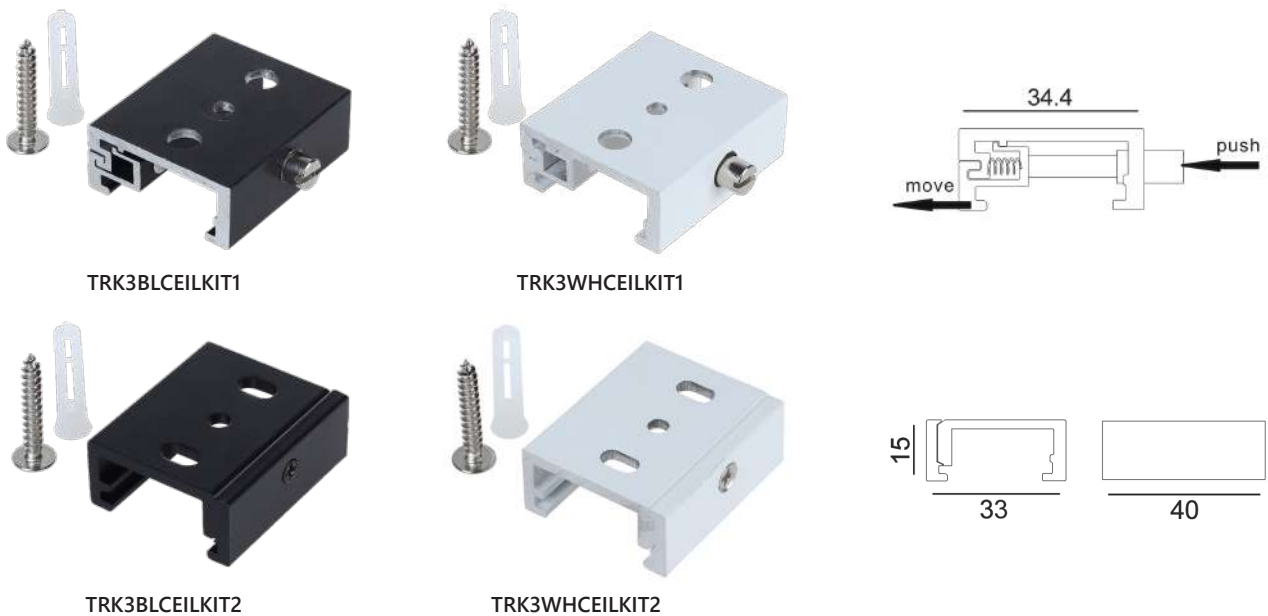

Part No.	Description	Carton QTY
TRK3BLCEILKIT1	TRACK 3 Circuit 4 Wire Ceiling Kit With Spring BLK	1/1
TRK3BLCEILKIT2	TRACK 3 Circuit 4 Wire Ceiling Clamp Kit For Track Connection BLK	1/1
TRK3WHCEILKIT1	TRACK 3 Circuit 4 Wire Ceiling Kit With Spring WH	1/1
TRK3WHCEILKIT2	TRACK 3 Circuit 4 Wire Ceiling Clamp Kit For Track Connection WH	1/1

4 Wire 3-Circuit Track Installation:

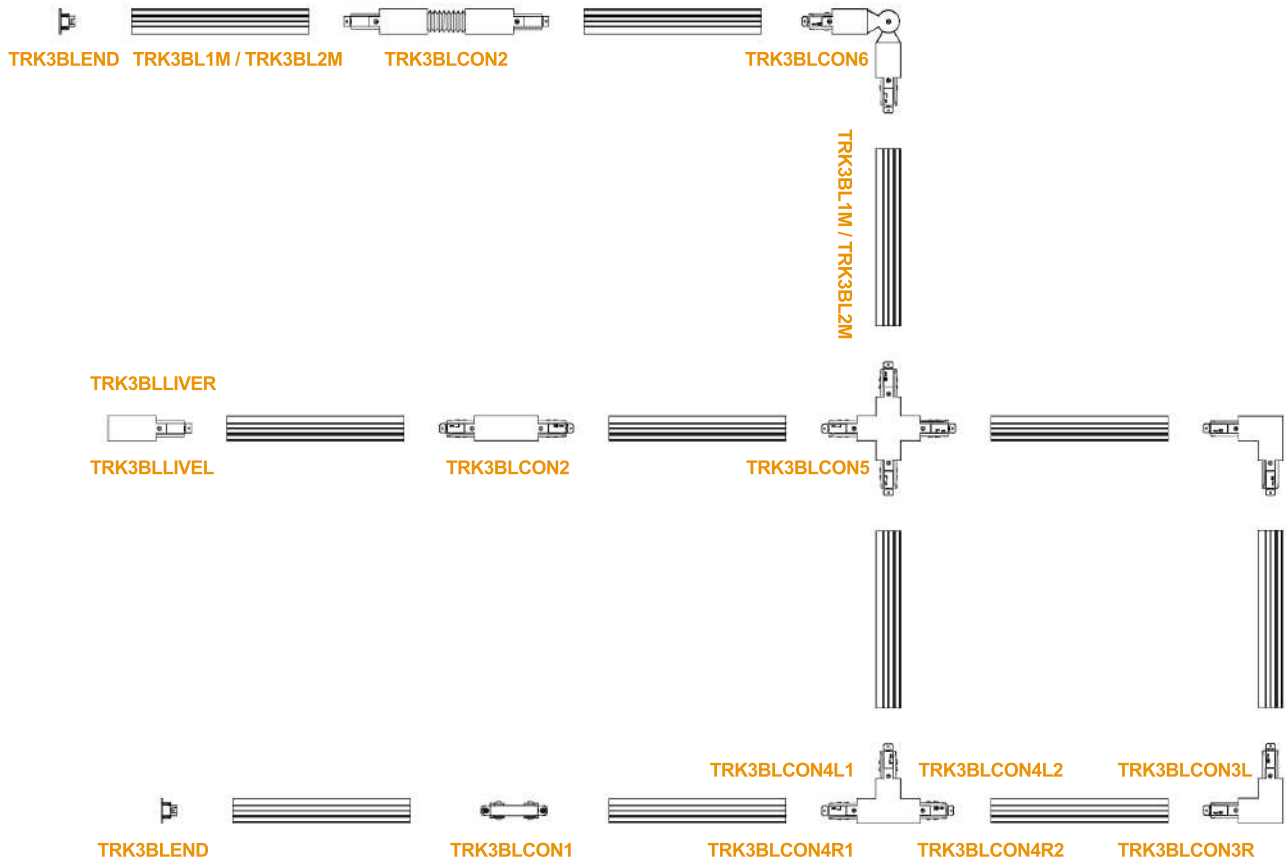

Installation :

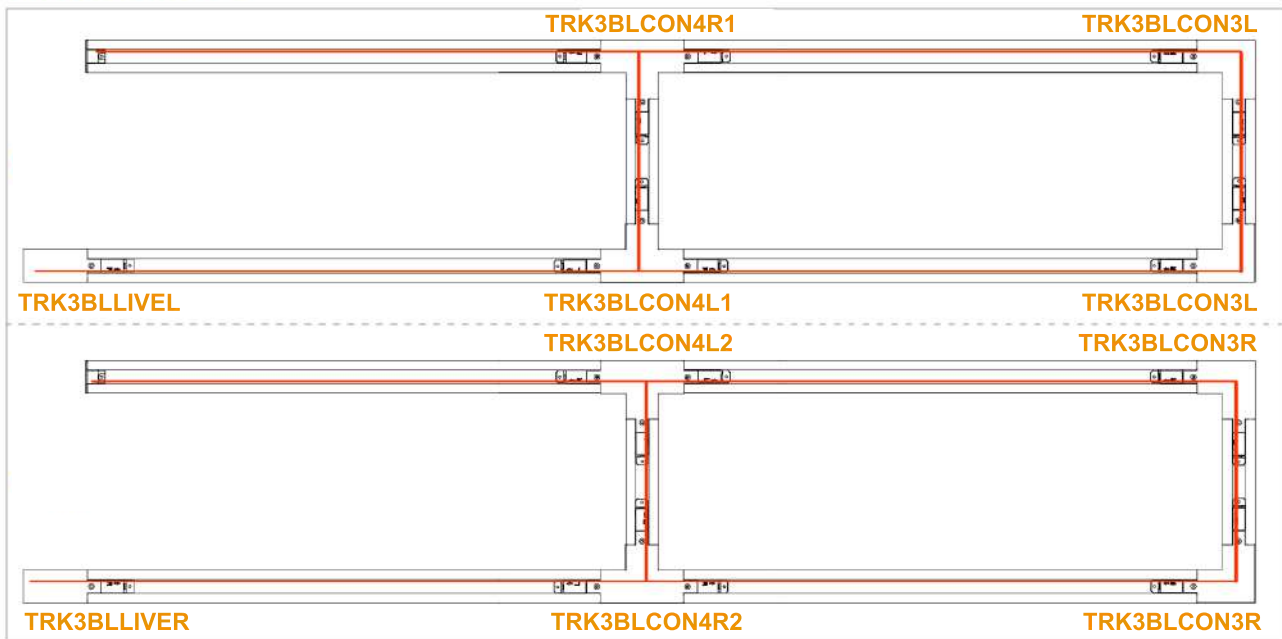

4 Wire 3-Circuit Track Pendant Light Adaptors



TRK3BLADAP3
TRACK 3 Circuit 4 Wire Adaptor Big
Hold Weight 10Kg Max BLK



TRK3WHADAP3
TRACK 3 Circuit 4 Wire Adaptor Big
Hold Weight 10Kg Max WH

- For 4 wire 3 circuit track
- Hold weight: 10kg Max
- Colour: black and white
- To be used with split nipple (Part No. TRK3BL/WHNIPCON sold separately)
- Warranty: 3 year replacement

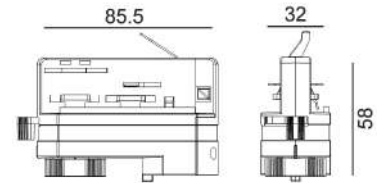

TRK3BLADAP4
TRACK 3 Circuit 4 Wire Adaptor Small
I Hold Weight 5Kg Max BLK



TRK3WHADAP4
TRACK 3 Circuit 4 Wire Adaptor Small
Small Hold Weight 5Kg Max BLK

- For 4 wire 3 circuit track
- Hold weight: 5kg Max
- Colour: black and white
- To be used with split nipple (Part No. TRK3BL/WHNIPCON sold separately)
- Warranty: 3 year replacement

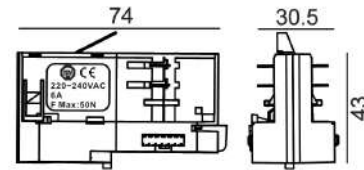

4 Wire 3-Circuit Track Split Nipple Connector



TRK3BLNIPCON
TRACK 3 Circuit 4 Wire Split Nipple
Connector BLK



TRK3WHNIPCON
TRACK 3 Circuit 4 Wire Split Nipple
Connector WH

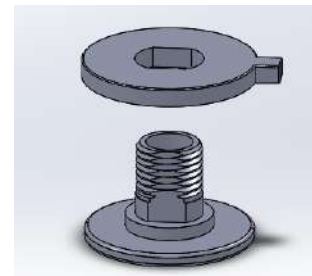

4 Wire 3-Circuit Track Suspension Kits



TRK3BLSUSKIT1
TRACK 3 Circuit 4 Wire Suspension
Mount Kit (With 1.5m Steel Wire) BLK



TRK3WHSUSKIT1
TRACK 3 Circuit 4 Wire Suspension
Mount Kit (With 1.5m Steel Wire) WH

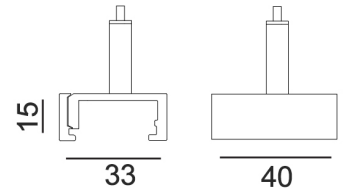

TRK3BLSUSKIT2
TRACK 3 Circuit 4 Wire Suspension Mount
Ezclick Kit (With 1.5m Steel Wire) BLK



TRK3WHSUSKIT2
TRACK 3 Circuit 4 Wire Suspension Mount
Ezclick Kit (With 1.5m Steel Wire) WH

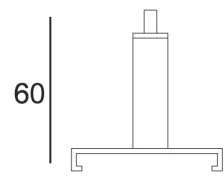

Rod(1m) →

TRK3BLSUSKIT3
TRACK 3 Circuit 4 Wire Suspension
Mount Rod Kit With M6x1 Metre
Threaded Rod BLK

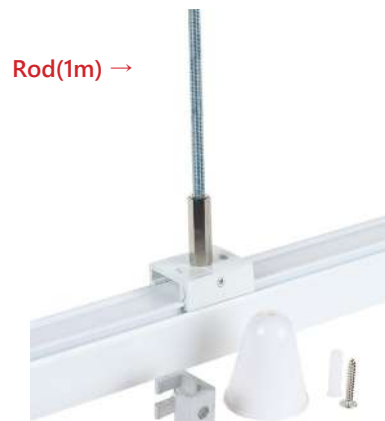

Rod(1m) →

TRK3WHSUSKIT3
TRACK 3 Circuit 4 Wire Suspension
Mount Rod Kit With M6x1 Metre
Threaded Rod WH

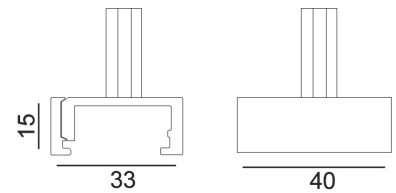

Rod(1m) →

TRK3BLSUSKIT4
TRACK 3 Circuit 4 Wire Suspension
Mount Ezclick Kit With M6x1 Metre
Threaded Rod BLK



Rod(1m) →

TRK3WHSUSKIT4
TRACK 3 Circuit 4 Wire Suspension
Mount Ezclick Kit With M6x1 Metre
Threaded Rod WH

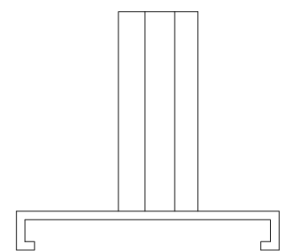



TRK3BLSUSKIT5

TRACK 3 Circuit 4 Wire Suspension Kit With Spring (Added With 1.5m Steel Wire) BLK



TRK3WHSUSKIT5

TRACK 3 Circuit 4 Wire Suspension Kit With Spring (Added With 1.5m Steel Wire) WH

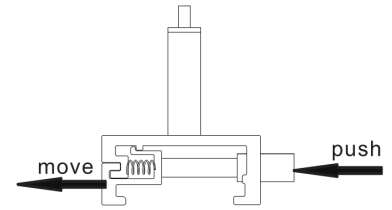

4 Wire 3-Circuit Track Suspension Clamp for Track Connection



TRK3BLSUSCLAMP

TRACK 3 Circuit 4 Wire Suspension Clamp For Track Connection BLK



TRK3WHSUSCLAMP

TRACK 3 Circuit 4 Wire Suspension Clamp For Track Connection WH

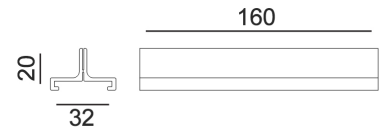

3 Wire 1 Circuit Tracks & Accessories Connectable Track Systems

3 Wire 1-Circuit Track

- Input voltage range: 220-240V/ 16A
- Material: PC and aluminium
- Colour: black and white
- Universal track



TRK1BL1M
TRK1BL2M



TRK1WH1M
TRK1WH2M

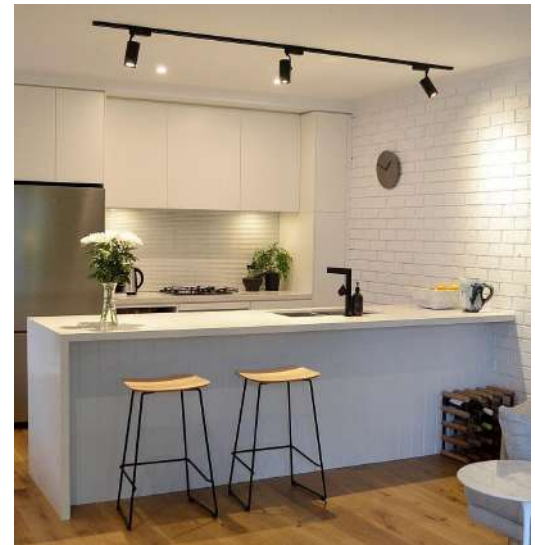
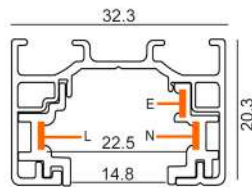

Part No.	Description	Dimensions	Carton QTY
TRK1BL1M	TRACK 1 Circuit 3 Wire 1M BLK (incl LIVE TRK1BLLIVER & END CAP TRK1BLEND)	L1000xW32.3xH20.3mm	1/20
TRK1BL2M	TRACK 1 Circuit 3 Wire 2M BLK (incl LIVE TRK1BLLIVER & END CAP TRK1BLEND)	L2000xW32.3xH20.3mm	1/20
TRK1WH1M	TRACK 1 Circuit 3 Wire 1M WH (incl LIVE TRK1WHLIVER & END CAP TRK1WHEND)	L1000xW32.3xH20.3mm	1/20
TRK1WH2M	TRACK 1 Circuit 3 Wire 2M WH (incl LIVE TRK1WHLIVER & END CAP TRK1WHEND)	L2000xW32.3xH20.3mm	1/20

3 Wire 1-Circuit Track Straight Connectors



TRK1BLCON1



TRK1WHCON1



TRK1BLCON2



TRK1WHCON2

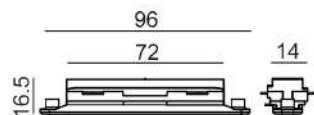

TRK1BLCON1
TRK1WHCON1

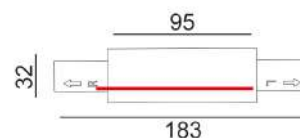

TRK1BLCON2
TRK1WHCON2

Part No.	Description	Carton QTY
TRK1BLCON1	TRACK 1 Circuit 3 Wire Mini Straight Connector BLK	1/100
TRK1BLCON2	TRACK 1 Circuit 3 Wire Straight Connector BLK	1/100
TRK1WHCON1	TRACK 1 Circuit 3 Wire Mini Straight Connector WH	1/100
TRK1WHCON2	TRACK 1 Circuit 3 Wire Straight Connector WH	1/100

3 Wire 1-Circuit Track 'L-Piece' Connectors (Left or right)



TRK1BLCON3R
TRK1BLCON3L



TRK1WHCON3R
TRK1WHCON3L

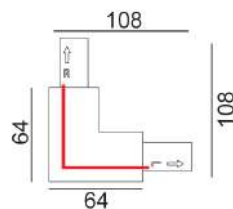

TRK1BLCON3L
TRK1WHCON3L

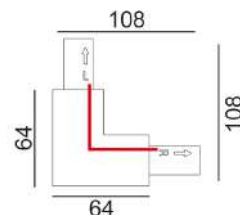

TRK1BLCON3R
TRK1WHCON3R

Part No.	Description	Carton QTY
TRK1BLCON3L	TRACK 1 Circuit 3 Wire L-Piece Connector - LEFT BLK	1/100
TRK1BLCON3R	TRACK 1 Circuit 3 Wire L-Piece Connector - RIGHT BLK	1/100
TRK1WHCON3L	TRACK 1 Circuit 3 Wire L-Piece Connector - LEFT WH	1/100
TRK1WHCON3R	TRACK 1 Circuit 3 Wire L-Piece Connector - RIGHT WH	1/100

3 Wire 1-Circuit Track 'T-Piece' Connectors (Left or right)



TRK1BLCON4L1
TRK1BLCON4L2
TRK1BLCON4R1
TRK1BLCON4R2



TRK1WHCON4L1
TRK1WHCON4L2
TRK1WHCON4R1
TRK1WHCON4R2

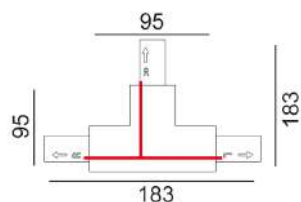

TRK1BLCON4L1
TRK1WHCON4L1

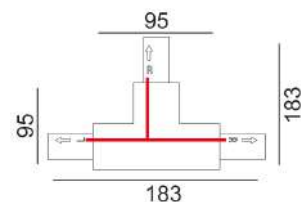

TRK1BLCON4L2
TRK1WHCON4L2

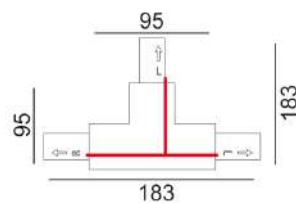

TRK1BLCON4R1
TRK1WHCON4R1

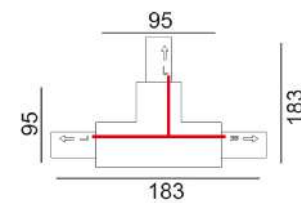

TRK1BLCON4R2
TRK1WHCON4R2

Part No.	Description	Carton QTY
TRK1BLCON4L1	TRACK 1 Circuit 3 Wire T-Piece Connector - LEFT1 BLK	1/100
TRK1BLCON4L2	TRACK 1 Circuit 3 Wire T-Piece Connector - LEFT2 BLK	1/100
TRK1BLCON4R1	TRACK 1 Circuit 3 Wire T-Piece Connector - RIGHT1 BLK	1/100
TRK1BLCON4R2	TRACK 1 Circuit 3 Wire T-Piece Connector - RIGHT2 BLK	1/100
TRK1WHCON4L1	TRACK 1 Circuit 3 Wire T-Piece Connector - LEFT1 WH	1/100
TRK1WHCON4L2	TRACK 1 Circuit 3 Wire T-Piece Connector - LEFT2 WH	1/100
TRK1WHCON4R1	TRACK 1 Circuit 3 Wire T-Piece Connector - RIGHT1 WH	1/100
TRK1WHCON4R2	TRACK 1 Circuit 3 Wire T-Piece Connector - RIGHT2 WH	1/100

3 Wire 1-Circuit Track 'Cross-Piece' & Elbow Connectors

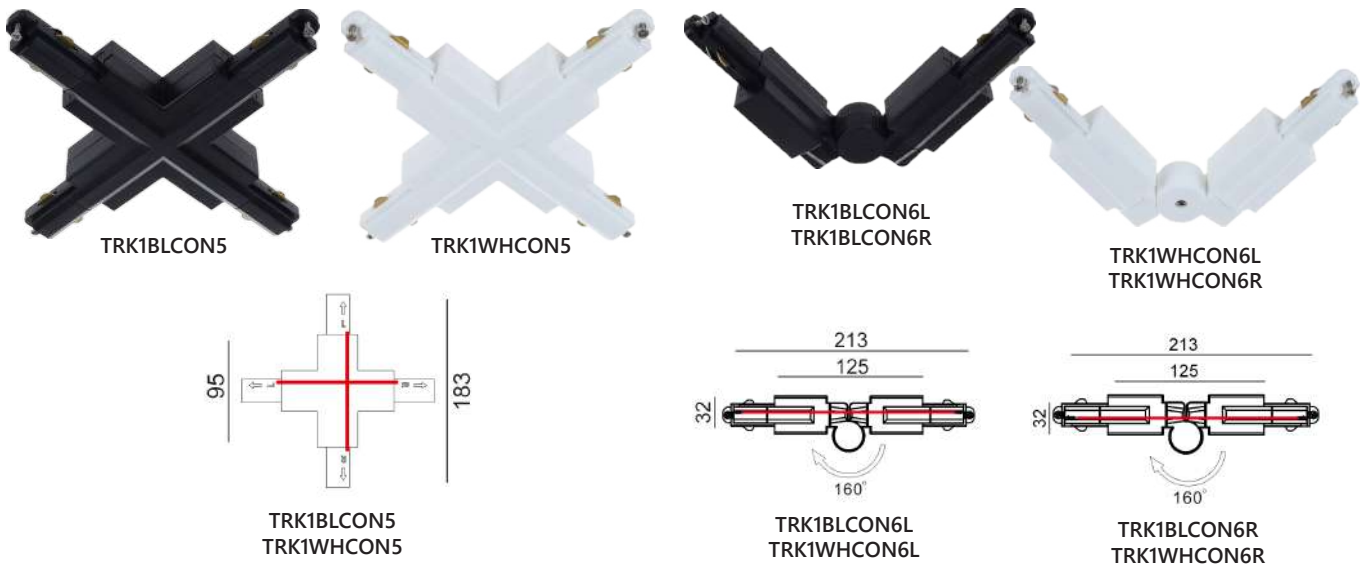

Part No.	Description	Carton QTY
TRK1BLCON5	TRACK 1 Circuit 3 Wire Cross-Piece Connector BLK	1/100
TRK1BLCON6L	TRACK 1 Circuit 3 Wire Elbow Connector- LEFT BLK	1/100
TRK1BLCON6R	TRACK 1 Circuit 3 Wire Elbow Connector- RIGHT BLK	1/100
TRK1WHCON5	TRACK 1 Circuit 3 Wire Cross-Piece Connector WH	1/100
TRK1WHCON6L	TRACK 1 Circuit 3 Wire Elbow Connector- LEFT WH	1/100
TRK1WHCON6R	TRACK 1 Circuit 3 Wire Elbow Connector- RIGHT WH	1/100

3 Wire 1-Circuit Track End Cap & Live End (Left or right)

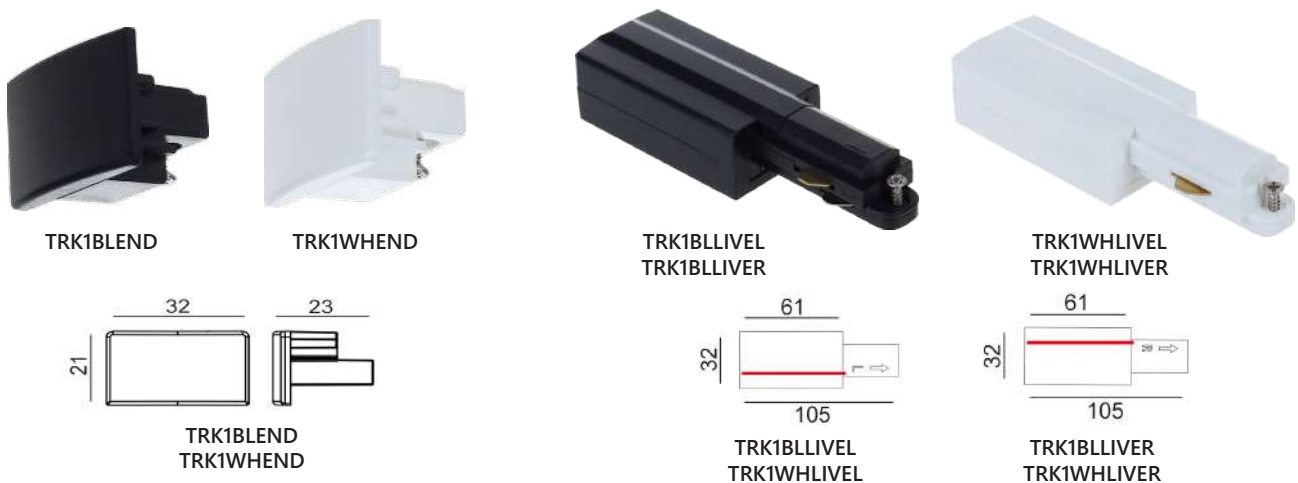

Part No.	Description	Carton QTY
TRK1BLEND	TRACK 1 Circuit 3 Wire End Cap BLK	1/100
TRK1BLLIVER	TRACK 1 Circuit 3 Wire TRACK LIVE END - LEFT BLK	1/100
TRK1BLLIVER	TRACK 1 Circuit 3 Wire TRACK LIVE END - RIGHT BLK	1/100
TRK1WHEND	TRACK 1 Circuit 3 Wire End Cap WH	1/100
TRK1WHLIVER	TRACK 1 Circuit 3 Wire TRACK LIVE END - LEFT WH	1/100
TRK1WHLIVER	TRACK 1 Circuit 3 Wire TRACK LIVE END - RIGHT WH	1/100

*NOTE: Except TRK1BL/WHCON1 & TRK1BL/WHCON6L/R, all our connectors and joiners have center feed facility (ability to connect with power supply)

3 Wire 1-Circuit Track Installation:

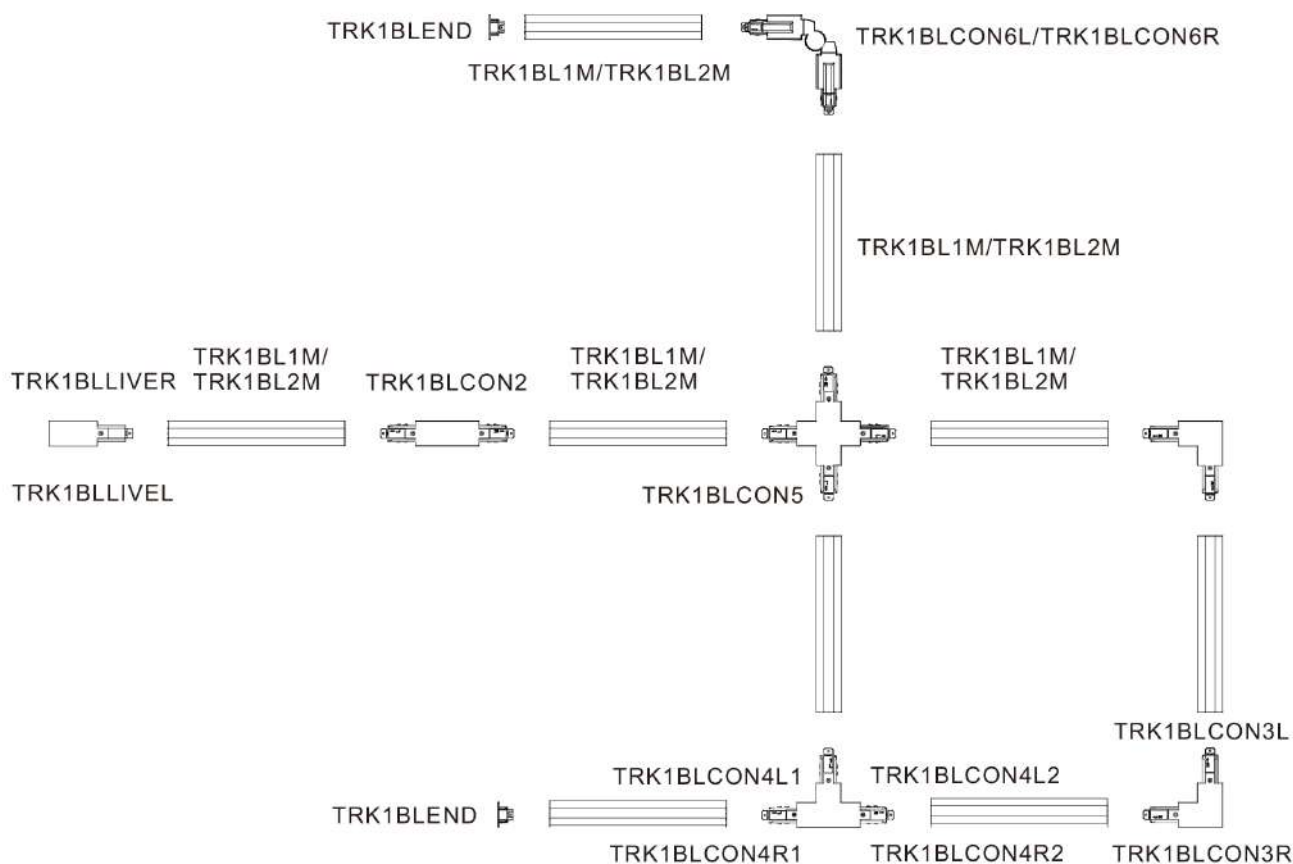

Installation :

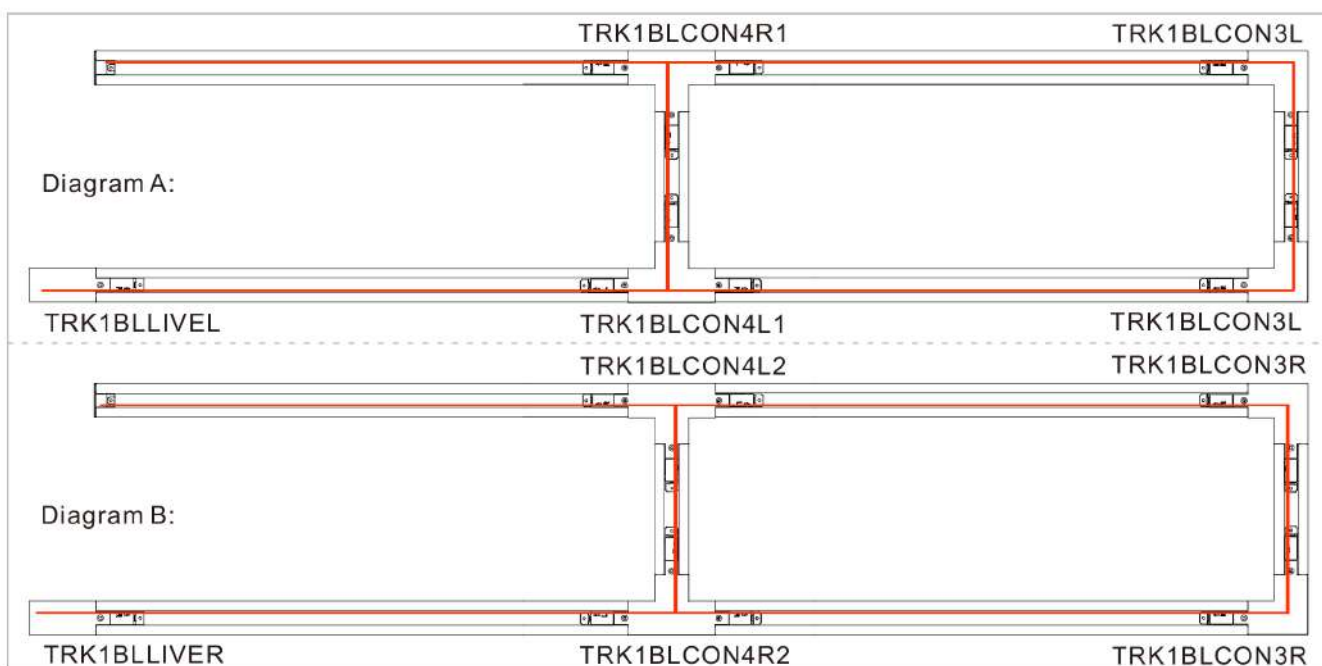

3 Wire 1 Circuit Track Pendant Light Adaptors



TRK1BLADAP1



TRK1WHADAP1

- For 3 wire 1 circuit track
- Hold weight: 5kg Max
- M10x16mm
- Colour: black and white
- Warranty: 3 year replacement

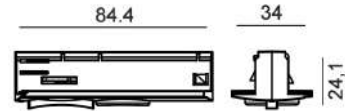

Part No.	Description
TRK1BLADAP1	TRACK 1 Circuit 3 Wire Adaptor Hold Weight 5Kg Max M10x16mm BLK
TRK1WHADAP1	TRACK 1 Circuit 3 Wire Adaptor Hold Weight 5Kg Max M10x16mm WH



TRK1BLADAP2



TRK1WHADAP2

- For 3 wire 1 circuit track
- Hold weight: 5kg Max.
- Colour: black and white
- Warranty: 3 year replacement

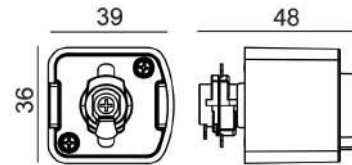

Part No.	Description
TRK1BLADAP2	TRACK 1 Circuit 3 Wire Square Adaptor Hold Weight 5Kg Max BLK
TRK1WHADAP2	TRACK 1 Circuit 3 Wire Square Adaptor Hold Weight 5Kg Max WH





GENERAL LIGHTING

Interior Utility Lights



Back plate

BAT001-002

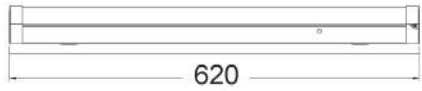

BAT001

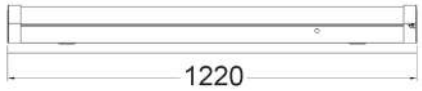

BAT002

- LED Tri-CCT dimmable oyster lights
- Input voltage: 220-240V
- Driver inbuilt
- Material: steel & PC
- Tri-CCT (3000K/ 4000K/ 5700K) in one fitting
- CCT switch inside the fitting
- Power factor: 0.9
- Ambient temperature: -20 to 40°C
- Not suitable for dimming
- Suitable for 2-way switching
- Suitable for use with 3 wire sensor
- **Large terminal block for easy installation**

30,000hr
Lifetime

110°
Beam Angle

IP20
Rated

3YEAR
Replacement
Warranty

Part No.	Description	Lumens				Dimensions		Carton QTY	
		3000K		4000K		5700K			
BAT001	BATTEN LED S/M 10W/20W Tri L620mm	10W	20W	10W	20W	10W	20W	620x65x70 mm	1/9
		900LM	1800LM	1100LM	2200LM	1000LM	2000LM		
BAT002	BATTEN LED S/M 20W/40W Tri L1220mm	20W	40W	20W	40W	20W	40W	1220x65x70 mm	1/9
		1800LM	3600LM	2200LM	4400LM	2000LM	4000LM		



RAZORDM001A-002A
(Central hole in mounting plate)



RAZORDM001A

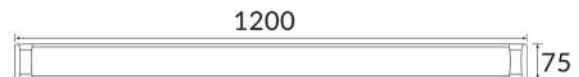

RAZORDM002A

- Interior LED dimmable Tri-CCT surface mounted battens
- Input voltage range: 220-240V AC 50/60Hz
- Constant current inbuilt driver included
- Housing: powder coated aluminium
- Diffuser: PC
- Heat sink: aluminium
- Tri-CCT (3000K/ 4000K/ 5000K) in one fitting
- LED chips: SMD2835
- Power factor: ≥ 0.9
- CRI: >80
- Ambient temperature: -20 to 40°C
- Suitable for dimming
- Suitable for 2-way switching
- Suitable for use with 3 wire motion or Microwave sensors

Tested & Recommended Dimmers:

Brand	Part No.
DIGINET	LEDsMart: MMDM/BP, MMDM/RT
Clipsal	Universal: 32ELEDM, 32E450UDM
HPM	CAT400L, CAT400T

30,000hr
Lifetime

110°
Beam Angle

IP20
Rated

DIMMABLE

3YEAR
Replacement
Warranty

Part No.	Lumens			LED Chips	Watt	CRI	Length	Width	Depth	Carton QTY
	3000K	4000K	5000K							
RAZORDM001A	1500LM	1700LM	1500LM	240pcs 2835	18W	>80	600mm	75mm	31mm	1/10
RAZORDM002A	3000LM	3400LM	3000LM	480pcs 2835	36W	>80	1200mm	75mm	31mm	1/10

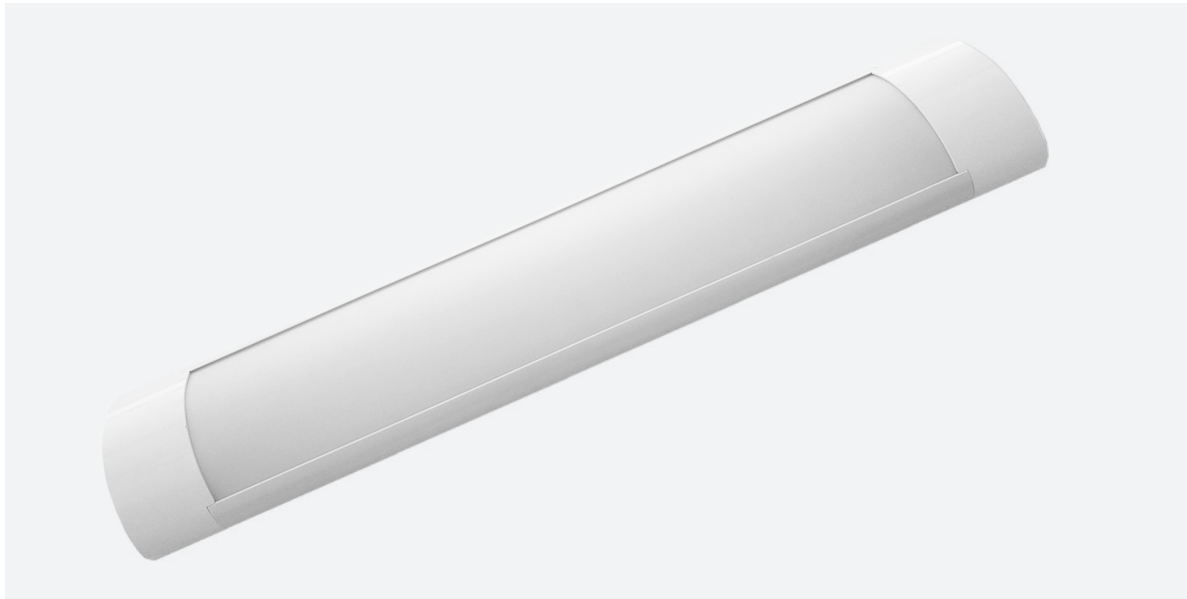

RAZORDMW001-002
(Wide Housing: 120mm; Central hole in mounting plate)

- Interior LED surface mounted dimmable Tri-CCT battens (Wide)
- Input voltage: 220-240V AC 50/60Hz
- Inbuilt driver included
- Diffuser: PC (white)
- Housing: powder coated aluminium
- Heatsink: aluminium
- High power factor: ≥ 0.9
- Tri-CCT (3000K/ 4000K/ 5000K) in one fitting
- Internal switch (under diffuser)
- Central hole in mounting plate
- LED chips: SMD2835
- CRI: >80
- Ambient temperature: -20 to 40°C
- Suitable for dimming with most trailing edge dimmers
- Suitable for 2-way switching
- Suitable for use with 3 wire Microwave & Motion sensors

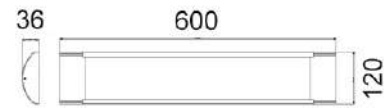

RAZORDMW001

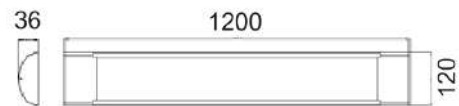

RAZORDMW002



Tested & Recommended Dimmers:

Brand	Part No.
CLIPSAL	32E450TM, 32E450UDM 32ELEDM 400W 41E300PBUD2SM-VM
HPM	Cat 400L, Cat400T, MMDM/BP400W, MMDM(RT)400W

Part No.	Description	Lumens			Watt	CRI	Power Factor	Dimensions	Carton QTY
		3000K	4000K	5000K					
RAZORDMW01	BATTEN LED S/M WH DIMM Central Hole 1700Lm TRI	1500LM	1700LM	1500LM	18W	>80	≥ 0.9	600x120mm	1/10
RAZORDMW02	BATTEN LED S/M WH DIMM Central Hole 3400Lm TRI	3000LM	3400LM	3000LM	36W	>80	≥ 0.9	1200x120mm	1/10



LINKTRI01-03

- Interior LED Tri-CCT linkable T5 slimline lights
 - Input voltage range: 220-240V AC 50/60Hz
 - Inbuilt driver
 - Housing: PC
 - Mounting bracket: aluminium
 - LED chips: SMD2835
 - Tri-CCT in one fitting: 3000K / 4000K / 5700K
 - Slide switch on side
 - CRI: ≥80
 - Power factor: >0.9
 - Flex & plug and connecting cables sold separately
 - Hardwire connecting cable and mounting bracket included in the box
 - Not suitable for dimming
 - Ambient temperature: -15 to 40°C
 - Note: All LINKTRI models can be used together.
- Maximum connection wattage: 150W



LINKTRIFP



LINKTRICN



15mm hardwire connecting cable included in the box

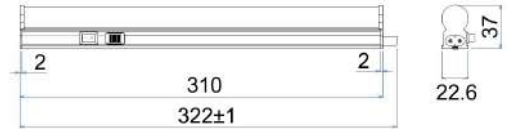

LINKTRI01



LINKTRI02

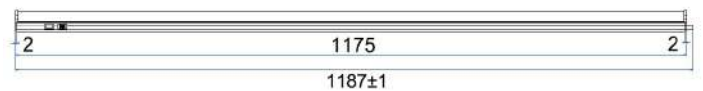

LINKTRI03

30,000hr
Lifetime

150°
Beam Angle

IP20
Rated

3YEAR
Replacement
Warranty

Part No.	Description	Lumens			Watt	CRI	Width	Length	Depth	Carton QTY
		3000K	4000K	5700K						
LINKTRI01	LINKABLE LED SLIM 4W TRI	380LM	420LM	400LM	4W	80	22.6mm	322mm	37mm	1/40
LINKTRI02	LINKABLE LED SLIM 9W TRI	855LM	945LM	900LM	9W	80	22.6mm	587mm	37mm	1/40
LINKTRI03	LINKABLE LED SLIM 18W TRI	1710LM	1890LM	1800LM	18W	80	22.6mm	1187mm	37mm	1/40
LINKTRICN	LINKABLE LED SLIM CONNECTOR 220mm (22cm) FOR LINKTRI SERIES									
LINKTRIFP	LINKABLE LED SLIM F&P 2 PIN 1.2M CABLE FOR LINKTRI SERIES									

Night Interior Utility Lights



NIGHT01

- Interior LED utility wall night light
- Input voltage: 220-250V AC
- Inbuilt LED driver
- Automatically Turns on at dusk and off at dawn
- No batteries required
- Rotates through 360° to light any direction
- For indoor use only

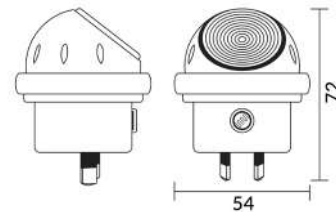

1. For best results, use in a place with ample natural light, unobstructed by window furnishings
2. To use safely, ensure the night light is fully inserted into socket
3. The photoelectric eye will sense fading light and automatically switch the night light on and off again as natural light return

Part No.	Description	Kelvin	Lumens	Watt	CRI	Dimensions	Carton QTY
NIGHT01	WALL INTERNAL LED PLUG IN NIGHTLIGHT	6500K	28LM	0.2W	-	72X54mm	12/96

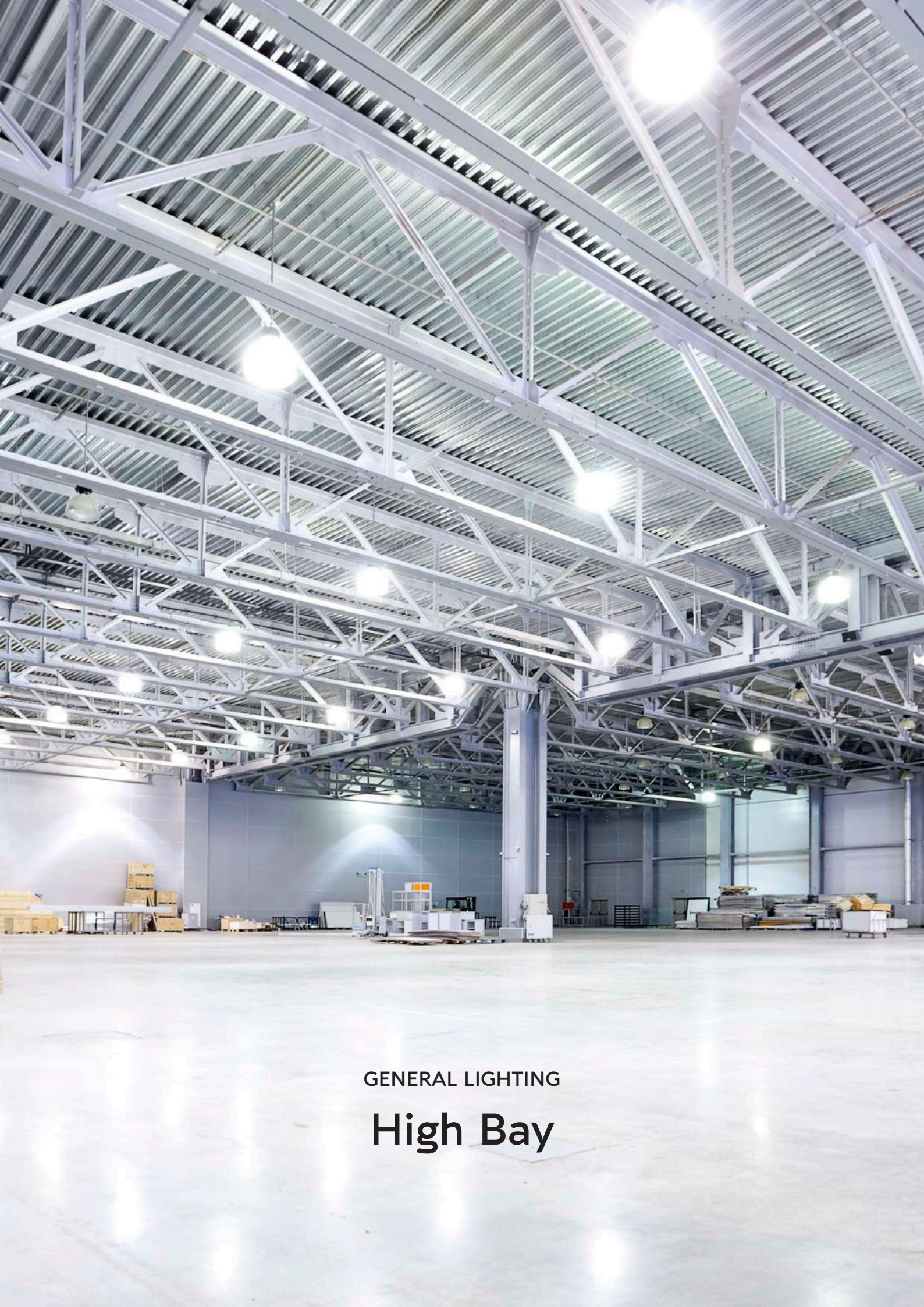

GENERAL LIGHTING

High Bay

Hibtri High Bay



HIBTRI1



- LED **power switchable** Tri-CCT high bay
- Input voltage range: 120-277V AC 50Hz
- Constant current LED driver inbuilt
- Housing & Faceplate: powder coated Aluminium
- Heatsink: Aluminium
- Diffuser: Clear PC
- LED chips: 2835
- Power factor: ≥ 0.95
- Flex & plug: 1.2m
- Ambient temp: -20 to 50°C
- Not suitable for dimming
- Suitable for 2-way switching
- Suitable for use with motion & microwave sensors

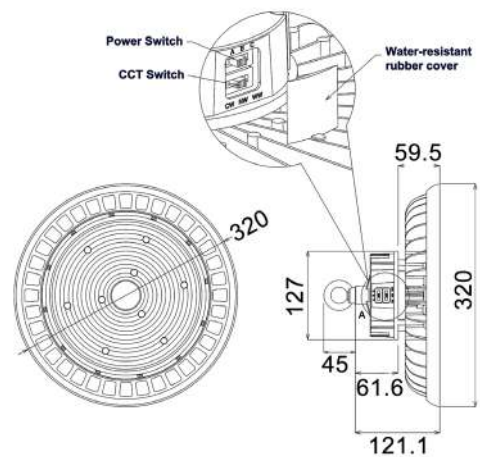

45,000hr
Lifetime

90°
Beam Angle

IP65
Rated

5YEAR
Replacement
Warranty

Part No.	Lumens									Carton QTY
	3000K			4000K			5700K			
	100W	150W	200W	100W	150W	200W	100W	150W	200W	
HIBTRI1	15500LM	21000LM	27000LM	17000LM	22500LM	29500LM	15500LM	21000LM	28000LM	1/1



GENERAL LIGHTING

Security Lights



Sec Security Lights



SEC01



SEC01S (with Sensor)



SEC02



SEC02S (with sensor)

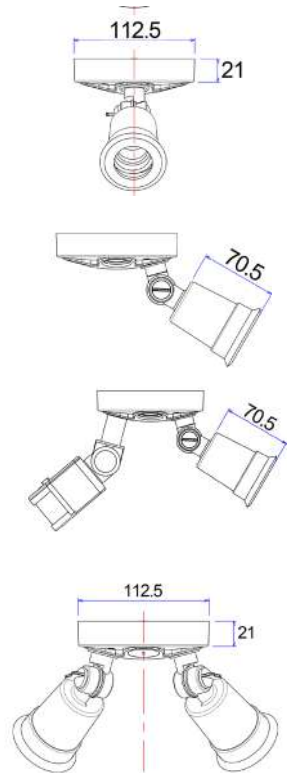

- Surface mounted LED PAR30 security Lights
- Adjustable: up/ down & side to side
- Input voltage: 240V AC
- Housing: PBT + PC
- Lamp holder: E27
- Max.150W PAR30 halogen globes
- **10W LED PAR30 globe (Part No. PAR3001) included**

Sensor Spec:

- Detection range: 180°
- Detection distance: 5-12m
- Detection motion speed: 0.6-1.5m/s
- Rated load: 1200W (HAL) 300W (CFL & LED)
- Time delay: Min: 10s±3s; Max: 10m±3min
- Ambient light: 3-2000 lux (adj)
- Ambient temperature: -10 to 40°C
- Installation height: 1.8-2.5m
- Manual override via light switch

LED Globes Other Spec (Part No. PAR3001):

- LED chips: 10pcs SMD2835
- Power factor: ≥0.5
- Ambient temperature: -10 to 40°C
- Suitable for 2-way switching
- Suitable for use with PIR sensor

30,000hr
Lifetime

IP44
Rated

40°
Beam Angle

3YEAR
Replacement
Warranty



PAR001

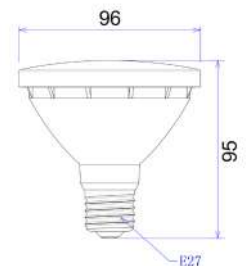

IP44
Rated

3YEAR
Replacement
Warranty

Part No.	Description	PAR3001 INFO						Carton QTY
		Kelvin	Lumens	Watt	CRI	Beam	LEDs	
SEC01	SECURITY PAR30 ES S/ADJ BLK without sensor	5000K	800LM	10W	80	40°	10pcs 2835	1/40
SEC01S	SECURITY PAR30 ES S/ADJ BLK with sensor	5000K	800LM	10W	80	40°	10pcs 2835	1/32
SEC02	SECURITY PAR30 X 2 ES D/ADJ BLK without sensor	5000K	2x800LM	2x10W	80	40°	10pcs 2835	1/24
SEC02S	SECURITY PAR30 X 2 ES D/ADJ BLK with sensor	5000K	2x800LM	2x10W	80	40°	10pcs 2835	1/24

Sec Security Lights



SEC03S
(White)



SEC04S
(Black)

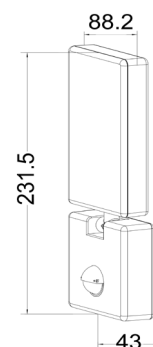

- Surface mounted LED security Lights with sensor
- Adjustable: head tilts down 90° and swivels 360°
- Input voltage range: 220-240V AC 50/60Hz
- Housing & diffuser: PC
- Mounting bracket: PC
- Heatsink: PC
- LED chips: 28pcs SMD2835
- CRI: >80
- Power factor: >0.9
- Ambient temperature: -20 to 40°C
- Suitable for 2-way switching

Sensor Spec:

- Sensor type: PIR
- Installation height: 1.8-2.5m
- Detection angle: 140°
- Motion detection distance: 9m Max
- Motion detection speed: 10 sec±3 sec to 5min±1min (Adjustable)
- UV resistant
- No manual override



Part No.	Description	Kelvin	Lumens	Watt	CRI	Beam	LEDs	Carton QTY
SEC03S	SECURITY FLOOD LED 15W S/ADJ WH with sensor	4000K	1100LM	15W	>80	120°	28pcs 2835	1/20
SEC04S	SECURITY FLOOD LED 15W S/ADJ BLK with sensor	4000K	1100LM	15W	>80	120°	28pcs 2835	1/20

Security Pillar Lights

Security Lights



SEC05
(Single Head)



SEC08
(Double Heads)



SEC08S
(Double Heads with Sensor)

- LED Tri-CCT security pillar lights with/without sensor
- Input voltage: 240V AC 50/60Hz
- Inbuilt Constant Current LED driver
- Adjustable: 180° (90° up/down and left/right)
- Housing: powder coated aluminium
- Mounting bracket: aluminium
- Diffuser: clear glass with honeycomb louver
- Tri-CCT (3000K/ 4000K/ 5500K)
- CCT inbuilt switch under back plate
- LED chips: 1616 LEDs
- CRI: ≥80
- Power factor: ≥0.9
- Ambient temperature: -10 to 40°C
- Not suitable for dimming
- Suitable for 2 way switching

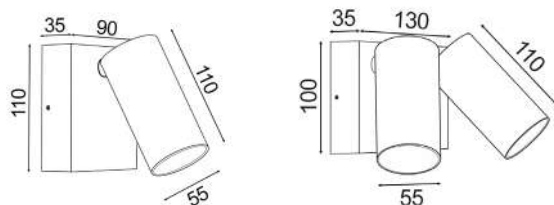

Sensor Technical Spec:

- Sensor type: PIR sensor
- Installation height: recommended 2-2.5m
- Detection angle: 120°
- Detection area: max.10m
- Detection range (ØxH): max.10m when installed 2-2.5m
- Time delay: 8 ± 5 sec to 12 ± 2 min (adjustable)
- Manual override: yes

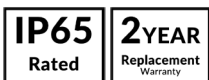

Part No.	Description	Lumens			Watt	Power Factor	CRI	Carton QTY
		3000K	4000K	5500K				
SEC05	Security S/ADJ LED WH No Sensor	760LM	800LM	850LM	8W	≥0.9	≥80	1/20
SEC08	D/ADJ LED Matte WH No Sensor	2x760LM	2x800LM	2x850LM	2x8W	≥0.9	≥80	1/10
SEC08S	D/ADJ LED Matte WH with Sensor	2x760LM	2x800LM	2x850LM	2x8W	≥0.9	≥80	1/10

Security Pillar Lights

Security Lights



SEC06
(Single Head)



SEC09
(Double Heads)



SEC09S
(Double Heads with Sensor)

- LED Tri-CCT security pillar lights with/without sensor
- Input voltage: 240V AC 50/60Hz
- Inbuilt Constant Current LED driver
- Adjustable: 180° (90° up/down and left/right)
- Housing: powder coated aluminium
- Mounting bracket: aluminium
- Diffuser: clear glass with honeycomb louver
- Tri-CCT (3000K/ 4000K/ 5500K)
- CCT inbuilt switch under back plate
- LED chips: 1616 LEDs
- CRI: ≥80
- Power factor: ≥0.9
- Ambient temperature: -10 to 40°C
- Not suitable for dimming
- Suitable for 2 way switching

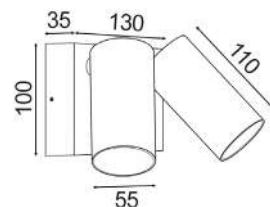
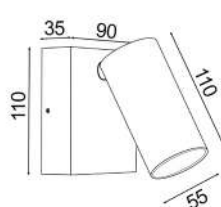

Sensor Technical Spec:

- Sensor type: PIR sensor
- Installation height: recommended 2-2.5m
- Detection angle: 120°
- Detection area: max.10m
- Detection range (ØxH): max.10m when installed 2-2.5m
- Time delay: 8 ± 5 sec to 12 ± 2 min (adjustable)
- Manual override: yes

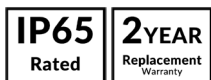

Part No.	Description	Lumens			Watt	Power Factor	CRI	Carton QTY
		3000K	4000K	5500K				
SEC06	Security S/ADJ LED BLK No Sensor	760LM	800LM	850LM	8W	≥0.9	≥80	1/20
SEC09	D/ADJ LED Matte BLK No Sensor	2x760LM	2x800LM	2x850LM	2x8W	≥0.9	≥80	1/10
SEC09S	D/ADJ LED Matte BLK with Sensor	2x760LM	2x800LM	2x850LM	2x8W	≥0.9	≥80	1/10

Security Pillar Lights

Security Lights



SEC07
(Single Head)



SEC10
(Double Heads)



SEC10S
(Double Heads with Sensor)

- LED Tri-CCT security pillar lights with/without sensor
- Input voltage: 240V AC 50/60Hz
- Inbuilt Constant Current LED driver
- Adjustable: 180° (90° up/down and left/right)
- Housing: anodized aluminium
- Mounting bracket: aluminium
- Diffuser: clear glass with honeycomb louver
- Tri-CCT (3000K/ 4000K/ 5500K)
- CCT inbuilt switch under back plate
- LED chips: 1616 LEDs
- CRI: ≥80
- Power factor: ≥0.9
- Ambient temperature: -10 to 40°C
- Not suitable for dimming
- Suitable for 2 way switching

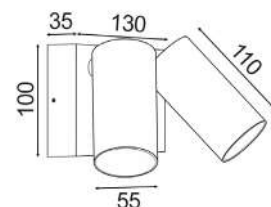
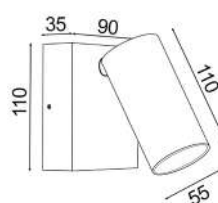

IP65
Rated

2YEAR
Replacement
Warranty

Sensor Technical Spec:

- Sensor type: PIR sensor
- Installation height: recommended 2-2.5m
- Detection angle: 120°
- Detection area: max.10m
- Detection range (ØxH): max.10m when installed 2-2.5m
- Time delay: 8 ± 5 sec to 12 ± 2 min (adjustable)
- Manual override: yes

Part No.	Description	Lumens			Watt	Power Factor	CRI	Carton QTY
		3000K	4000K	5500K				
SEC07	Security S/ADJ LED Titanium No Sensor	760LM	800LM	850LM	8W	≥0.9	≥80	1/20
SEC10	D/ADJ LED Titanium No Sensor	2x760LM	2x800LM	2x850LM	2x8W	≥0.9	≥80	1/10
SEC10S	D/ADJ LED Titanium with Sensor	2x760LM	2x800LM	2x850LM	2x8W	≥0.9	≥80	1/10



SEC11S

- LED Tri-CCT adjustable security light with sensor
- Input voltage: 220-240V 50/60Hz
- Housing, faceplate & heatsink: plastic
- Diffuser: clear glass
- LED chips: 48pcs(3000K) + 48pcs (6500K) SMD2835
- Tri-CCT (3000K/ 4000K/ 6500K) in one fitting
- CCT switch inside the fitting
- Power Factor: >0.9
- CRI: >80
- Beam angle: 270° (3x90°)
- Adjustable / Tilt / Swivel: 270°
- Ambient temperature: -20 to 40°C
- Not suitable for dimming
- Suitable for 2 way switching
- Double insulated

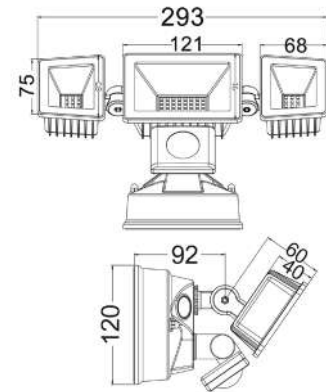

Sensor Technical Spec:

- Sensor type: PIR
- Wattage / power consumption: <0.5W
- Installation height: 1.8-3.5m
- Detection angle: 140° Max
- Motion detection speed: 1.5m/s
- Time delay: 8secs to 9mins
- UV resistant: yes
- Manual override: yes

15,000hr
Lifetime

270°
Beam Angle

IP65
Rated

2YEAR
Replacement
Warranty

Part No.	Description	Lumens			Watt	PF	CRI	Carton QTY
		3000K	4000K	6500K				
SEC11S	SECURITY S/M 30W LED TRI Blk w/sensor	2700LM	3000LM	2800LM	10W	>0.9	>80	1/12

GENERAL LIGHTING



GLOBES

LED Globes



SMTGU10

Globes - LED Globes

SMART LIGHTS



- GU10 LED smart Globe
- Input voltage range: 220-240V 50/60Hz
- Shade & diffuser: plastic
- LED chips: 20pcs SMD2835
- CRI: ≥ 80
- Power factor: 0.5
- Ambient temperature: -20 to 30°C
- App: control all functions via Tuya app on smart devices
- Manual: on/off control via normal wall switch
- Dimmable only via app or voice control through Amazon Alexa, Google Home and other compatible voice activated control devices (Not compatible with wall switch dimmer)
- Setup requires WiFi with Internet connection
- Suitable for 2-way switching
- Not suitable for use with sensors



SMTGU101

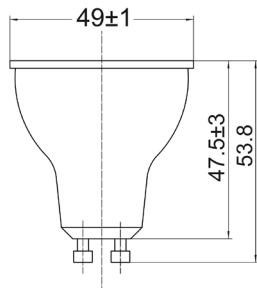

 Tuya Smart
Formal version



Scan QRCode to download

Additional SMART Features:

- Tuneable RGB colour spectrum (up to 14 million colours)
- Tuneable colour temperature (3000K warm white through to 6500K daylight)
- Works with any 2.4GHz enabled WiFi network (note: will not currently pair with 5.0GHz bandwidth.) or Bluetooth LE 4.2
- Create schedules and timing to automate your home
- Control from anywhere via app or voice control using Alexa Hubs, Google Home and other compatible devices
- Compatible with all Tuya Powered apps



Part No.	Description	Base	Kelvin	Lumens	Watt	Dimensions	Carton QTY
SMTGU101	GLOBE LED SMART GU10 5W RGB TRI CCT	GU10	RGB+ 3000- 6000K	360-450LM- 3000K 400-500LM- 4000K 400-500LM-6000K	5W	Ø50X53.8mm	1/10/100

GU10TRI

Globes - LED Globes



GU10TRI1

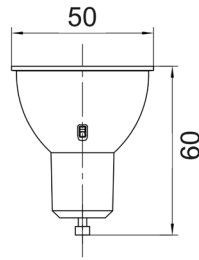

- GU10 LED Tri-CCT globe
- Input voltage: 176-264V AC
- Diffuser: plastic white
- Housing: plastic & aluminium
- Heatsink: PBT
- LED chips: 10pcs SMD2835
- Tri-CCT (3000K/ 4000K/ 5000K)
- CCT switch on housing
- CRI: ≥ 80
- Power factor: ≥ 0.5
- Ambient temperature: -20 to 40°C
- Not suitable for dimming
- Suitable for 2 way switching
- Suitable for use with sensors



Part No.	Description	Lumens			Watt	Size	Carton QTY
		3000K	4000K	5000K			
GU10TRI1	GLOBE LED GU10 6W TRI	432LM	495LM	605LM	6W	Ø50x60mm	1/10/100

GU10 LED Globes

Globes - LED Globes



GU1001-02

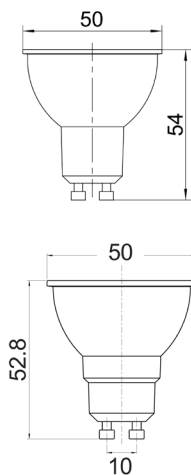

- GU10 LED globes
- Input voltage range: 240V AC 50/60Hz
- Constant current LED driver inbuilt
- Housing: Plastic
- LED chips: SMD2835
- Power factor: > 0.5
- Ambient temperature: -20 to 40°C
- Not suitable for dimming
- Suitable for 2 way switching
- Suitable for use with 3 wire PIR or microwave sensors
- IP rating: GU1001A: IP20; GU1002: IP40
- Warranty: GU1001A: 2 year replacement; GU1002: 1 year replacement



Part No.	Description	Base	Kelvin	Lumens	Watt	CRI	Dimensions	Carton QTY
GU1001A	GLOBE LED GU10 6W 3000K FR 120D	GU10	3000K	470LM	6W	≥ 80	Ø50x54mm	1/10/100
GU1002	GLOBE LED GU10 6W 5000K FR 120D	GU10	5000K	485LM	6W	≥ 80	Ø50x52.8mm	1/10/100

GU10 Dimmable LED Globes

Globes - LED Globes



- GU10 dimmable LED globes
- Input voltage range: 220-240V AC
- Inbuilt constant current LED driver
- Housing & diffuser: glass
- Power factor: >0.7
- LED chips: 6pcs SMD2835
- Ambient temperature: -20 to 50°C
- Suitable for dimming
- Suitable for 2-way switching
- Suitable for use with PIR sensor



GU1003D-04D

Part No.	Description	Base	Kelvin	Lumens	Watt	CRI	Dimensions	Carton QTY
GU1003D	GLOBE LED GU10 DIMM 5W 3000K CLR	GU10	3000K	400LM	5W	>80	Ø50x56mm	1/10/100
GU1004D	GLOBE LED GU10 DIMM 5W 5000K CLR	GU10	5000K	400LM	5W	>80	Ø50x56mm	1/10/100

GU10 Coloured LED Globes

Globes - LED Globes



- GU10 coloured LED globe
- Input voltage range: 220-240V AC
- Inbuilt constant current LED driver
- Housing: plastic
- Power factor: 0.5
- LED chips: 10pcs SMD2835
- Ambient temperature: -10 to 40°C
- Not suitable for dimming
- Suitable for 2-way switching
- Suitable for use with PIR sensor



GU10B/G/R01A

Part No.	Description	Base	Kelvin	Lumens	Watt	CRI	Dimensions	Carton QTY
GU10B01A	GLOBE LED AC GU10 5W BLUE	GU10	BLUE	50LM	5=30W	N/A	Ø50x56mm	1/200
GU10G01A	GLOBE LED AC GU10 5W GREEN	GU10	GREEN	50LM	5=30W	N/A	Ø50x56mm	1/200
GU10R01A	GLOBE LED AC GU10 5W RED	GU10	RED	50LM	5=30W	N/A	Ø50x56mm	1/200

MR16TRI

Globes - LED Globes

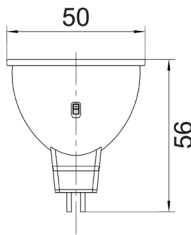

MR16TRI1

- MR16 TRI-CCT LED globe
- Input voltage: 12V AC/DC
- Diffuser: plastic white
- Housing: plastic & aluminium
- Heatsink: PBT
- LED chips: 10pcs SMD2835
- Tri-CCT (3000K/ 4000K/ 5000K)
- CCT switch on housing
- CRI: ≥ 80
- Power factor: ≥ 0.5
- Ambient temperature: -20 to 40°C
- Not suitable for dimming
- Not suitable for 2 way switching
- Not suitable for use with sensors

20,000hr
Lifetime

60°
Beam Angle

IP20
Rated

2YEAR
Replacement
Warranty

Part No.	Description	Lumens			Watt	Size	Carton QTY
		3000K	4000K	5000K			
MR16TRI1	GLOBE LED MR16 6W TRI	432LM	495LM	605LM	6W	Ø50x56mm	1/10/100

MR16 LED Globes

Globes - LED Globes

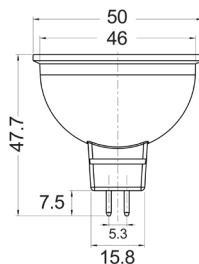

MR1601A-02A

- MR16 LED globes
- Input voltage: 12V AC/DC
- Driver input voltage: 12V 50/60Hz
- Housing & heat sink: aluminium & plastic
- LED chips: 6pcs SMD2835
- Power factor: ≥ 0.5
- CRI: 80
- Ambient temperature: -15 to 40°C
- Not suitable for dimming
- Suitable for 2 way switching
- Suitable for use with 3 wire PIR or Microwave sensors
- Remote constant voltage AC/DC control gear required

MR16

25,000hr
Lifetime

38°
Beam Angle

IP40
Rated

1YEAR
Replacement
Warranty

Part No.	Description	Base	Kelvin	Lumens	Watt	CRI	Dimensions	Carton QTY
MR1601A	GLOBE LED 12V AC/DC (Wh) MR16 3000K	MR16	3000K	480LM	6=40W	80	Ø50x47.7mm	1/10/100
MR1602A	GLOBE LED 12V AC/DC (Wh) MR16 5000K	MR16	5000K	495LM	6=40W	80	Ø50x47.7mm	1/10/100

MR16 Coloured Globes Globes - LED Globes



MR16B, G, R01A

- MR16 coloured LED globes
- Input voltage: 12V AC/DC
- Housing: plastic & aluminium
- Wattage: 5W (=30W incandescent)
- Power factor: 0.8
- LED chips: 10pcs SMD2835 LED
- Ambient temperature: -10 to 40°C
- Not suitable for dimming
- Suitable for 2-way switching
- Suitable for use with PIR sensor
- Remote constant voltage AC/DC control gear required

MR16	25,000hr Lifetime	70° Beam Angle	IP20 Rated	2YEAR Replacement Warranty
------	-------------------	----------------	----------------------	--------------------------------------



Part No.	Description	Base	Kelvin	Lumens	Watt	CRI	Dimensions	Carton QTY
MR16B01A	GLOBE LED 12V AC/DC MR16 BLUE	MR16	BLUE	50LM	5=30W	N/A	Ø50x46mm	1/200
MR16G01A	GLOBE LED 12V AC/DC MR16 GREEN	MR16	GREEN	50LM	5=30W	N/A	Ø50x46mm	1/200
MR16R01A	GLOBE LED 12V AC/DC MR16 RED	MR16	RED	50LM	5=30W	N/A	Ø50x46mm	1/200

MR11 LED Globes Globes - LED Globes



MR1101-02

- MR11 LED globes
- Input voltage: 12V AC/DC
- Heatsink: aluminium
- Wattage: 4W=30W Incandescent globe
- LED chips: 3pcs SMD2835
- CRI: >80
- Power factor: ≥0.5
- Ambient temperature: -20 to 50°C
- Not suitable for dimming
- Suitable for 2 way switching
- Suitable for use with sensors
- Remote control gear required

MR11	15,000hr Lifetime	35° Beam Angle	IP20 Rated	2YEAR Replacement Warranty
------	-------------------	----------------	----------------------	--------------------------------------

Part No.	Description	Base	Kelvin	Lumens	Watt	Dimensions	Carton QTY
MR1101	GLOBE LED 12V GU4 AC/DC MR11 4W 3000K	GU4	3000K	260LM	4W	Ø34.8X38.5mm	1/10/100
MR1102	GLOBE LED 12V GU4 AC/DC MR11 4W 5000K	GU4	5000K	260LM	4W	Ø34.8X38.5mm	1/10/100



SMTGLS1-2

- GLS LED smart Globe
- Input voltage range: 220-240V 50/60Hz
- Housing: plastic & aluminium
- Diffuser: plastic
- Frosted Diffuser
- LED chips: 20pcs SMD2835
- CRI: ≥80
- Power factor: ≥0.5
- Ambient temperature: -20 to 30°C
- App: control all functions via Tuya app on smart devices
- Manual: on/off control via normal wall switch
- Dimmable only via app or voice control through Amazon Alexa, Google Home and other compatible voice activated control devices (Not compatible with wall switch dimmer)
- Setup requires WiFi connection
- Suitable for 2-way switching
- Not suitable for use with sensor

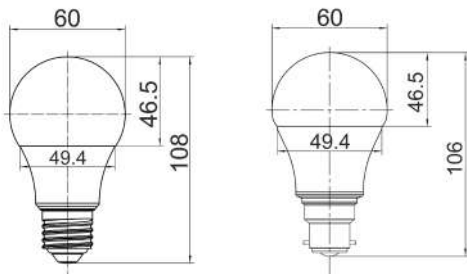

Additional SMART Features:

- Tuneable RGB colour spectrum (up to 14 million colours)
- Tuneable colour temperature (3000K warm white through to 6500K daylight)
- Works with any 2.4GHz enabled WiFi network (note: will not currently pair with 5.0GHz bandwidth.) or Bluetooth LE 4.2
- Create schedules and timing to automate your home
- Control from anywhere via app or voice control using Alexa Hubs, Google Home and other compatible devices
- Compatible with all Tuya Powered apps



Scan QRCode to download



Part No.	Description	Base	Kelvin	Lumens	Watt	Dimensions	Carton QTY
SMTGLS1	GLOBE LED SMART ES GLS 10W RGB TRI CCT	E27	RGB+ 3000- 6000K	700-800LM- 3000K 750-880LM- 4000K	10W	Ø60X108mm	1/10/100
SMTGLS2	GLOBE LED SMART BC GLS 10W RGB TRI CCT	B22		750-880LM-6000K	10W	Ø60X108mm	1/10/100

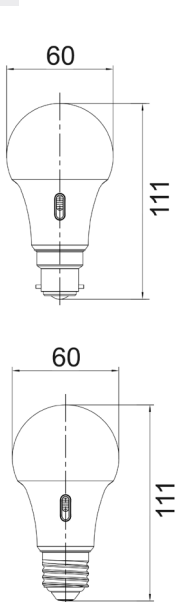
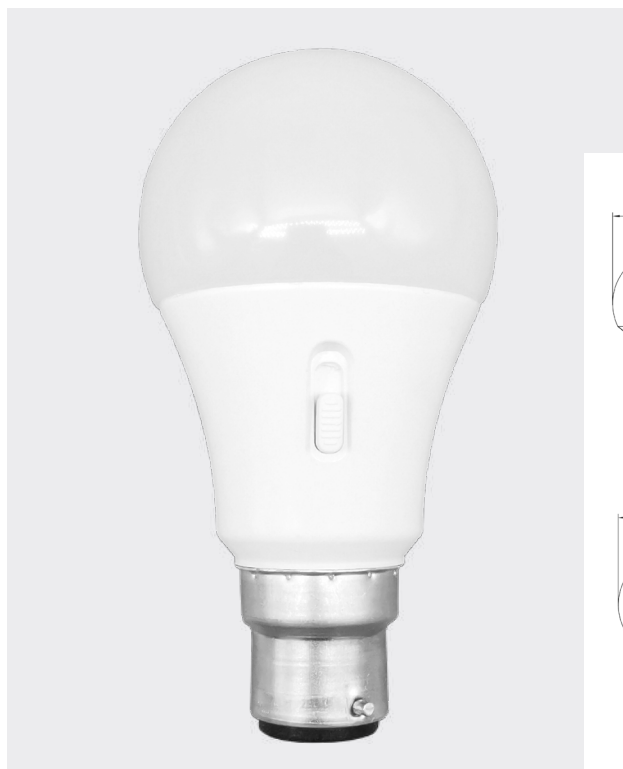

- Input voltage: 176-264V AC
- Diffuser: plastic frosted
- Housing: plastic & aluminium
- Heatsink: PBT
- LED chips: 16pcs SMD2835
- Tri-CCT (3000K/ 4000K/ 5000K)
- CCT switch on housing
- CRI: ≥ 80
- Power factor: ≥ 0.5
- Ambient temperature: -20 to 40°C
- Not suitable for dimming
- Suitable for 2 way switching
- Suitable for use with sensors

20,000hr
Lifetime

180°
Beam Angle

IP20
Rated

2YEAR
Replacement
Warranty

Part No.	Description	Base	Lumens			Watt	Dimensions	Carton QTY
			3000K	4000K	5000K			
GLSTRIBC1	GLOBE LED BC GLS 10W TRI	B22	729LM	792LM	891LM	10W	Ø60x111mm	1/10/50
GLSTRIES1	GLOBE LED ES GLS 10W TRI	E27	729LM	792LM	891LM	10W	Ø60x111mm	1/10/50

GLS LED Filament Globes (8W) Globes - LED Globes

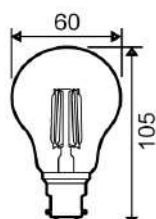

- LED filament GLS dimmable globes
- Input Voltage range: 180-260V AC 50/60Hz
- Diffuser: clear glass
- LED chips: 4x24pcs 5131JC
- Power factor: >0.7
- Ambient temperature: -20 to 50°C
- Suitable for dimming
- Suitable for 2-way switching
- Suitable for use with PIR or Microwave sensors

25,000hr
Lifetime

360°
Beam Angle

IP20
Rated

DIMMABLE

2YEAR
Replacement
Warranty

Tested & Recommended Dimmers:

Brand	Part No.
CLA	VELA
LEGRAND	Cat AR400A3PM
CLIPSAL	32ELEDM, 32E450TM, 31E2RUDM, 32E450UDM
DIGINET	MEDM

Part No.	Description	Base	Kelvin	Lumens	Watt	CRI	Dimensions	Carton QTY
CF14DIM	GLOBE LED CARBON LOOK DIMM BC GLS 8W	B22	2700K	800LM	8=75W	>80	Ø60x105mm	1/25/100
CF15DIM	GLOBE LED CARBON LOOK DIMM BC GLS 8W	B22	6000K	800LM	8=75W	>80	Ø60x105mm	1/25/100
CF16DIM	GLOBE LED CARBON LOOK DIMM ES GLS 8W	E27	2700K	800LM	8=75W	>80	Ø60x105mm	1/25/100
CF17DIM	GLOBE LED CARBON LOOK DIMM ES GLS 8W	E27	6000K	800LM	8=75W	>80	Ø60x105mm	1/25/100



- Input voltage: 180-260V
- Heatsink: aluminium
- Diffuser: frosted glass
- LED chips: 4x24pcs 5131JC
- Power factor: >0.7
- CRI: >80
- Ambient temp: -20 to 50°C
- Suitable for use with dimmers
- Suitable for 2-way switching
- Suitable for use with sensors



Tested & Recommended Dimmers:

Brand	Part No.
CLA	VELA
LEGRAND	Cat AR400A3PM
CLIPSAL	32ELEDM, 32E450TM, 31E2RUDM, 32E450UDM
DIGINET	MEDM

Part No.	Description	Base	Kelvin	Lumens	Watt	Dimensions	Carton QTY
GLS36D	GLOBE LED BC GLS 8W DIMM FR	B22	2700K	800LM	8W	Ø60x105mm	1/25/100
GLS37D	GLOBE LED ES GLS 8W DIMM FR	E27	2700K	800LM	8W	Ø60x105mm	1/25/100
GLS38D	GLOBE LED BC GLS 8W DIMM FR	B22	6000K	800LM	8W	Ø60x105mm	1/25/100
GLS39D	GLOBE LED ES GLS 8W DIMM FR	E27	6000K	800LM	8W	Ø60x105mm	1/25/100

GLS LED Globes (6-15W) Globes - LED Globes



- Input voltage range: 176-264V AC 50/60Hz
- Material: PBT, aluminium, plastic & PC
- Diffuser: frosted plastic
- LED chips: 2835 LED
- Power factor: ≥ 0.5
- Ambient temperature: -15 to 40°C
- Not suitable for dimming
- Suitable for 2 way switching
- Suitable for use with sensors



Part No.	Description	Base	Kelvin	Lumens	Watt	CRI	Dimensions	Carton QTY
6W								
GLS13B	GLOBE LED ES GLS 6W 3000K FR 180D	E27	3000K	470LM	6W	>80	Ø60x109mm	1/10/50
GLS14B	GLOBE LED ES GLS 6W 5000K FR 180D	E27	5000K	490LM	6W	>80	Ø60x109mm	1/10/50
GLS15B	GLOBE LED BC GLS 6W 3000K FR 180D	B22	3000K	470LM	6W	>80	Ø60x108mm	1/10/50
GLS16B	GLOBE LED BC GLS 6W 5000K FR 180D	B22	5000K	490LM	6W	>80	Ø60x108mm	1/10/50
10W								
GLS31	GLOBE LED BC GLS 10W 3000K FR 180D	B22	3000K	800LM	10W	>80	Ø60x108mm	1/10/50
GLS32	GLOBE LED BC GLS 10W 5000K FR 180D	B22	5000K	825LM	10W	>80	Ø60x108mm	1/10/50
GLS33	GLOBE LED ES GLS 10W 3000K FR 180D	E27	3000K	800LM	10W	>80	Ø60x109mm	1/10/50
GLS34	GLOBE LED ES GLS 10W 5000K FR 180D	E27	5000K	825LM	10W	>80	Ø60x109mm	1/10/50
13W								
GLS21B	GLOBE LED ES GLS 13W 3000K FR 180D	E27	3000K	1055LM	13W	>80	Ø60x117mm	1/10/50
GLS22B	GLOBE LED ES GLS 13W 5000K FR 180D	E27	5000K	1107LM	13W	>80	Ø60x117mm	1/10/50
GLS23B	GLOBE LED BC GLS 13W 3000K FR 180D	B22	3000K	1055LM	13W	>80	Ø60x117mm	1/10/50
GLS24B	GLOBE LED BC GLS 13W 5000K FR 180D	B22	5000K	1107LM	13W	>80	Ø60x117mm	1/10/50
15W								
GLS25B	GLOBE LED BC GLS 15W 3000K FR 180D	B22	3000K	1348LM	15W	>80	Ø60x117mm	1/10/50
GLS26B	GLOBE LED ES GLS 15W 3000K FR 180D	E27	3000K	1348LM	15W	>80	Ø60x117mm	1/10/50
GLS27B	GLOBE LED BC GLS 15W 5000K FR 180D	B22	5000K	1470LM	15W	>80	Ø60x117mm	1/10/50
GLS28B	GLOBE LED ES GLS 15W 5000K FR 180D	E27	5000K	1470LM	15W	>80	Ø60x117mm	1/10/50

GLS LED Dimmable Globes (10W) Globes - LED Globes



- Input voltage range: 176-264V AC 50/60Hz
- Constant current LED driver inbuilt
- Heat sink: aluminium-plastic
- Diffuser: frosted plastic
- LED chips: SMD2835 LED
- Power factor: ≥ 0.7
- Ambient temperature: -15 to 40°C
- Dimmable with most trailing edge or leading edge dimmers
- Suitable for 2-way switching
- Suitable for use with sensors



Tested & Recommended Dimmers:

Brand	Part No.
CLIPSAL	32E450UDM
CLIPSAL	32E350UDM
HPM Legrand	CAT400T

Part No.	Description	Base	Kelvin	Lumens	Watt	CRI	Dimensions	Carton QTY
GLS9DB	GLOBE LED BC GLS DIMM 10W 3000K FR	B22	3000K	810LM	10W	>80	Ø60x108mm	1/10/50
GLS10DB	GLOBE LED ES GLS DIMM 10W 3000K FR	E27	3000K	810LM	10W	>80	Ø60x109mm	1/10/50
GLS11DB	GLOBE LED BC GLS DIMM 10W 5000K FR	B22	5000K	850LM	10W	>80	Ø60x108mm	1/10/50
GLS12DB	GLOBE LED ES GLS DIMM 10W 5000K FR	E27	5000K	850LM	10W	>80	Ø60x109mm	1/10/50
GLS29D	GLOBE LED BC GLS DIMM 10W 4000K FR	B22	4000K	810LM	10W	>80	Ø60x108mm	1/10/50
GLS30D	GLOBE LED ES GLS DIMM 10W 4000K FR	E27	4000K	810LM	10W	>80	Ø60x109mm	1/10/50

Fancy Round LED Dimmable Globes (4W) Globes - LED Globes

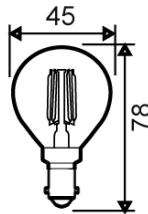
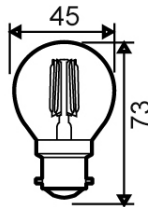

- LED filament G45 dimmable globes
- Input Voltage range: 180-260V AC 50/60Hz
- Diffuser: clear glass
- LED chips: 4x24pcs 5131JC
- Power factor: >0.7
- Ambient temperature: -20 to 50°C
- Suitable for use with dimmers
- Suitable for 2-way switching
- Suitable for use with PIR or Microwave sensors



Tested & Recommended Dimmers:

Brand	Part No.
CLA	VELA
LEGRAND	Cat AR400A3PM
CLIPSAL	32ELEDM, 32E450TM, 31E2RUDM, 32E450UDM
DIGINET	MEDM

Part No.	Description	Base	Kelvin	Lumens	Watt	CRI	Dimensions	Carton QTY
CF30DIM	GLOBE LED CARBON LOOK BC G45 4W	B22	2700K	400LM	4=40W	>80	Ø45x73mm	1/25/100
CF31DIM	GLOBE LED CARBON LOOK BC G45 4W	B22	6000K	400LM	4=40W	>80	Ø45x73mm	1/25/100
CF32DIM	GLOBE LED CARBON LOOK E27 G45 4W	E27	2700K	400LM	4=40W	>80	Ø45x73mm	1/25/100
CF33DIM	GLOBE LED CARBON LOOK E27 G45 4W	E27	6000K	400LM	4=40W	>80	Ø45x73mm	1/25/100
CF34DIM	GLOBE LED CARBON LOOK SBC G45 4W	B15	2700K	400LM	4=40W	>80	Ø45x78mm	1/25/100
CF35DIM	GLOBE LED CARBON LOOK SBC G45 4W	B15	6000K	400LM	4=40W	>80	Ø45x78mm	1/25/100
CF36DIM	GLOBE LED CARBON LOOK SES G45 4W	E14	2700K	400LM	4=40W	>80	Ø45x78mm	1/25/100
CF37DIM	GLOBE LED CARBON LOOK SES G45 4W	E14	6000K	400LM	4=40W	>80	Ø45x78mm	1/25/100

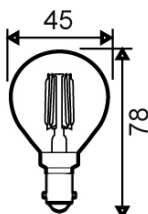
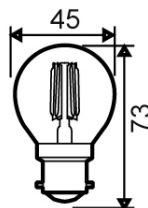

- Input voltage: 180-260V
- Heatsink: aluminium
- Diffuser: frosted glass
- LED chips: 4x24pcs 5131JC
- Power factor: >0.7
- CRI: >80
- Ambient temp: -20 to 50°C
- Suitable for use with dimmers
- Suitable for 2-way switching
- Suitable for use with sensors



Tested & Recommended Dimmers:

Brand	Part No.
CLA	VELA
LEGRAND	Cat AR400A3PM
CLIPSAL	32ELEDM, 32E450TM, 31E2RUDM, 32E450UDM
DIGINET	MEDM

Part No.	Description	Base	Kelvin	Lumens	Watt	CRI	Dimensions	Carton QTY
FR41D	GLOBE LED DIMM filament 4W F/RND	B22	2700K	400LM	4W	>80	Ø45x73mm	1/25/100
FR42D	GLOBE LED DIMM filament 4W F/RND	B22	6000K	400LM	4W	>80	Ø45x73mm	1/25/100
FR43D	GLOBE LED DIMM filament 4W F/RND	E27	2700K	400LM	4W	>80	Ø45x73mm	1/25/100
FR44D	GLOBE LED DIMM filament 4W F/RND	E27	6000K	400LM	4W	>80	Ø45x73mm	1/25/100
FR45D	GLOBE LED DIMM filament 4W F/RND	B15	2700K	400LM	4W	>80	Ø45x78mm	1/25/100
FR46D	GLOBE LED DIMM filament 4W F/RND	B15	6000K	400LM	4W	>80	Ø45x78mm	1/25/100
FR47D	GLOBE LED DIMM filament 4W F/RND	E14	2700K	400LM	4W	>80	Ø45x78mm	1/25/100
FR48D	GLOBE LED DIMM filament 4W F/RND	E14	6000K	400LM	4W	>80	Ø45x78mm	1/25/100

Fancy Round LED Globes (3W) Globes - LED Globes



- Input voltage: 240V AC 50/60Hz
- Heatsink: aluminium
- Housing: aluminium-plastic & PC
- Diffuser: frosted
- LED chips: 6pcs SMD2835 LED
- Power factor: ≥ 0.4
- Ambient temperature: -15 to 40°C
- Not suitable for dimming
- Suitable for 2 way switching
- Suitable for use with PIR or Microwave sensors

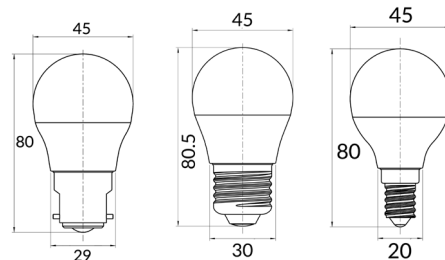

Part No.	Description	Base	Kelvin	Lumens	Watt	CRI	Dimensions	Carton QTY
FR36	GLOBE LED SES F/RND 3W 3000K FR 180D	E14	3000K	235LM	3=25W	80	Ø45x80mm	1/10/100
FR37	GLOBE LED BC F/RND 3W 5000K FR 180D	B22	5000K	260LM	3=25W	80	Ø45x80mm	1/10/100
FR40	GLOBE LED SES 3W F/RND 5000K FR 180D	E14	5000K	260LM	3=25W	80	Ø45x80mm	1/10/100

Candle LED Filament Globes (4W) Globes - LED Globes

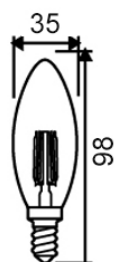

- Input Voltage range: 180-260V AC 50/60Hz
- Diffuser: clear glass
- LED chips: 4x24pcs 5131JC
- Power factor: >0.7
- Ambient temperature: -20 to 50°C
- Suitable for dimming
- Suitable for 2-way switching
- Suitable for use with PIR or Microwave sensors



Tested & Recommended Dimmers:

Brand	Part No.
CLA	VELA
LEGRAND	Cat AR400A3PM
CLIPSAL	32ELEDM, 32E450TM, 31E2RUDM, 32E450UDM
DIGINET	MEDM

Part No.	Description	Base	Kelvin	Lumens	Watt	CRI	Dimensions	Carton QTY
CF38DIM	GLOBE LED CARBON LOOK BC C37 4W	B22	2700K	400LM	4=40W	>80	Ø35x93mm	1/25/100
CF39DIM	GLOBE LED CARBON LOOK BC C37 4W	B22	6000K	400LM	4=40W	>80	Ø35x93mm	1/25/100
CF40DIM	GLOBE LED CARBON LOOK ES C37 4W	E27	2700K	400LM	4=40W	>80	Ø35x93mm	1/25/100
CF41DIM	GLOBE LED CARBON LOOK ES C37 4W	E27	6000K	400LM	4=40W	>80	Ø35x93mm	1/25/100
CF42DIM	GLOBE LED CARBON LOOK SBC C37 4W	B15	2700K	400LM	4=40W	>80	Ø35x98mm	1/25/100
CF43DIM	GLOBE LED CARBON LOOK SBC C37 4W	B15	6000K	400LM	4=40W	>80	Ø35x98mm	1/25/100
CF44DIM	GLOBE LED CARBON LOOK SES C37 4W	E14	2700K	400LM	4=40W	>80	Ø35x98mm	1/25/100
CF45DIM	GLOBE LED CARBON LOOK SES C37 4W	E14	6000K	400LM	4=40W	>80	Ø35x98mm	1/25/100

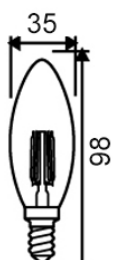
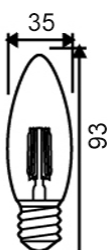

- Input Voltage range: 180-260V AC 50/60Hz
- Diffuser: frosted glass
- LED chips: 4x24pcs 5131JC
- Power factor: >0.7
- Ambient temperature: -20 to 50°C
- Suitable for dimming
- Suitable for 2-way switching
- Suitable for use with PIR or Microwave sensors



Tested & Recommended Dimmers:

Brand	Part No.
CLA	VELA
LEGRAND	Cat AR400A3PM
CLIPSAL	32ELEDM, 32E450TM, 31E2RUDM, 32E450UDM
DIGINET	MEDM

Part No.	Description	Base	Kelvin	Lumens	Watt	CRI	Dimensions	Carton QTY
CAN33D	GLOBE LED DIMM filament 4W candle	B22	2700K	400LM	4W	>80	Ø35x93mm	1/25/100
CAN34D	GLOBE LED DIMM filament 4W candle	B22	6000K	400LM	4W	>80	Ø35x93mm	1/25/100
CAN35D	GLOBE LED DIMM filament 4W candle	E27	2700K	400LM	4W	>80	Ø35x93mm	1/25/100
CAN36D	GLOBE LED DIMM filament 4W candle	E27	6000K	400LM	4W	>80	Ø35x93mm	1/25/100
CAN37D	GLOBE LED DIMM filament 4W candle	B15	2700K	400LM	4W	>80	Ø35x98mm	1/25/100
CAN38D	GLOBE LED DIMM filament 4W candle	B15	6000K	400LM	4W	>80	Ø35x98mm	1/25/100
CAN39D	GLOBE LED DIMM filament 4W candle	E14	2700K	400LM	4W	>80	Ø35x98mm	1/25/100
CAN40D	GLOBE LED DIMM filament 4W candle	E14	6000K	400LM	4W	>80	Ø35x98mm	1/25/100

Candle LED Globes (3W) Globes - LED Globes



- Input voltage range: 176-264V AC 50/60Hz
- Housing: aluminium-plastic & PC
- Diffuser: frosted
- Heat sink: aluminium
- Power factor: >0.5
- Ambient temperature: -15 to 40°C
- Not suitable for dimming

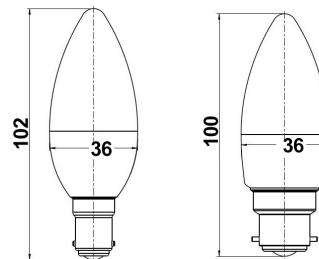

Part No.	Description	Base	Kelvin	Lumens	Watt	CRI	Dimensions	Carton QTY
CAN17	GLOBE LED SBC CAN 3W 5000K FR	B15	5000K	260LM	3=25W	≥80	Ø36x102mm	1/10/100
CAN18	GLOBE LED BC CAN 3W 5000K FR	B22	5000K	260LM	3=25W	≥80	Ø36x100mm	1/10/100
CAN20	GLOBE LED ES CAN 3W 5000K FR	E27	5000K	260LM	3=25W	≥80	Ø36x100mm	1/10/100
CAN24	GLOBE LED ES CAN 3W 3000K FR	E27	3000K	250LM	3=25W	≥80	Ø36x100mm	1/10/100

T40 LED Globes (9W) Globes - LED Globes



- Input voltage range: 220-240V AC 50/60Hz
- Constant current LED driver inbuilt
- Housing: aluminium-plastic
- Heat sink: aluminium
- LED chips: 10pcs SMD2835 LED
- Power factor: >0.5
- Ambient temperature: -25 to 40°C
- Not suitable for dimming
- Suitable for 2-way switching
- Suitable for use with Microwave and PIR sensors



Part No.	Description	Base	Kelvin	Lumens	Watt	CRI	Dimensions	Carton QTY
LT4010	GLOBE LED BC T40 9W 3000K FR	B22	3000K	800LM	9W	≥80	Ø37.2x114mm	1/10/100
LT4011	GLOBE LED BC T40 9W 4000K FR	B22	4000K	800LM	9W	≥80	Ø37.2x114mm	1/10/100
LT4012	GLOBE LED BC T40 9W 5000K FR	B22	5000K	800LM	9W	≥80	Ø37.2x114mm	1/10/100
LT4013	GLOBE LED BC T40 9W 6000K FR	B22	6000K	800LM	9W	≥80	Ø37.2x114mm	1/10/100
LT4014	GLOBE LED ES T40 9W 3000K FR	E27	3000K	800LM	9W	≥80	Ø37.2x115mm	1/10/100
LT4015	GLOBE LED ES T40 9W 4000K FR	E27	4000K	800LM	9W	≥80	Ø37.2x115mm	1/10/100
LT4016	GLOBE LED ES T40 9W 5000K FR	E27	5000K	800LM	9W	≥80	Ø37.2x115mm	1/10/100
LT4017	GLOBE LED ES T40 9W 6000K FR	E27	6000K	800LM	9W	≥80	Ø37.2x115mm	1/10/100

T40 LED Globes (9W) Globes - LED Globes



- Input voltage range: 220-240V AC 50/60Hz
- Constant current LED driver inbuilt
- Housing: aluminium-plastic
- Heat sink: aluminium
- LED chips: 10pcs SMD2835 LED
- Power factor: >0.7
- Ambient temperature: -25 to 40°C
- Suitable for dimming
- Suitable for 2-way switching
- Suitable for use with Microwave and PIR sensors



Tested & Recommended Dimmers:

Brand	Part No.
PDL	654M, 654TM
Legrand	CAT 400T
Diginet - LED smart	MEDM
Clipsal	32E450UDM, 32E450LM, 32ELEDM

Part No.	Description	Base	Kelvin	Lumens	Watt	CRI	Dimensions	Carton QTY
LT40D01	GLOBE LED BC T40 9W 3000K FR DIMM	B22	3000K	800LM	9W	≥80	Ø37.2x114mm	1/10/100
LT40D02	GLOBE LED BC T40 9W 4000K FR DIMM	B22	4000K	800LM	9W	≥80	Ø37.2x114mm	1/10/100
LT40D03	GLOBE LED BC T40 9W 5000K FR DIMM	B22	5000K	800LM	9W	≥80	Ø37.2x114mm	1/10/100
LT40D04	GLOBE LED BC T40 9W 6000K FR DIMM	B22	6000K	800LM	9W	≥80	Ø37.2x114mm	1/10/100
LT40D07	GLOBE LED ES T40 9W 5000K FR DIMM	E27	5000K	800LM	9W	≥80	Ø37.2x115mm	1/10/100
LT40D08	GLOBE LED ES T40 9W 6000K FR DIMM	E27	6000K	800LM	9W	≥80	Ø37.2x115mm	1/10/100

G95 LED Filament Globes (6W) Globes - LED Globes

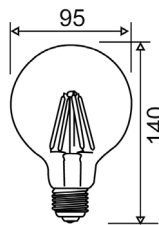

- LED filament G95 dimmable globes
- Input Voltage range: 180-260V AC 50/60Hz
- Diffuser: clear glass
- LED chips: 4x24pcs 5131JC
- Power factor: >0.7
- Ambient temperature: -20 to 50°C
- Suitable for dimming
- Suitable for 2-way switching
- Suitable for use with PIR or Microwave sensors



Tested & Recommended Dimmers:

Brand	Part No.
CLA	VELA
LEGRAND	Cat AR400A3PM
CLIPSAL	32ELEDM, 32E450TM, 31E2RUDM, 32E450UDM
DIGINET	MEDM

Part No.	Description	Base	Kelvin	Lumens	Watt	CRI	Dimensions	Carton QTY
CF18DIM	GLOBE LED CARBON LOOK BC G95 6W	B22	2700K	600LM	6=60W	>80	Ø95x140mm	1/50
CF19DIM	GLOBE LED CARBON LOOK BC G95 6W	B22	6000K	600LM	6=60W	>80	Ø95x140mm	1/50
CF20DIM	GLOBE LED CARBON LOOK E27 G95 6W	E27	2700K	600LM	6=60W	>80	Ø95x140mm	1/50
CF21DIM	GLOBE LED CARBON LOOK E27 G95 6W	E27	6000K	600LM	6=60W	>80	Ø95x140mm	1/50

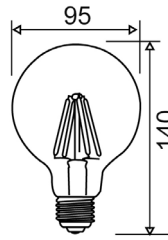

- LED filament G95 dimmable globes
- Input Voltage range: 180-260V AC 50/60Hz
- Diffuser: frosted glass
- LED chips: 4x24pcs 5131JC
- Power factor: >0.7
- Ambient temperature: -20 to 50°C
- Suitable for dimming
- Suitable for 2-way switching
- Suitable for use with PIR or Microwave sensors



Tested & Recommended Dimmers:

Brand	Part No.
CLA	VELA
LEGRAND	Cat AR400A3PM
CLIPSAL	32ELEDM, 32E450TM, 31E2RUDM, 32E450UDM
DIGINET	MEDM

Part No.	Description	Base	Kelvin	Lumens	Watt	CRI	Dimensions	Carton QTY
G959	GLOBE LED BC G95 6W FR DIMM	B22	2700K	600LM	6W	>80	Ø95x140mm	1/25/50
G9510	GLOBE LED ES G95 6W FR DIMM	E27	2700K	600LM	6W	>80	Ø95x140mm	1/25/50
G9511	GLOBE LED BC G95 6W FR DIMM	B22	6000K	600LM	6W	>80	Ø95x140mm	1/25/50
G9512	GLOBE LED ES G95 6W FR DIMM	E27	6000K	600LM	6W	>80	Ø95x140mm	1/25/50

G95 LED Globes (6W) Globes - LED Globes

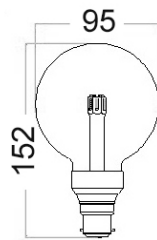

- Input voltage range: 90-264V AC 50/60Hz
- Housing & heat sink: aluminium
- Diffuser: clear glass
- LED chips: 21pcs 2835
- Power factor: ≥0.5
- Ambient temperature: -15 to 40°C
- Not suitable for dimming
- Suitable for use with sensors



Part No.	Description	Base	Kelvin	Lumens	Watt	CRI	Dimensions	Carton QTY
G953	GLOBE LED BC G95 6W CLR 5000K 300D	B22	5000K	650LM	6=40W	80	Ø95x152mm	1/40
G954	GLOBE LED ES G95 6W CLR 5000K 300D	E27	5000K	650LM	6=40W	80	Ø95x152mm	1/40

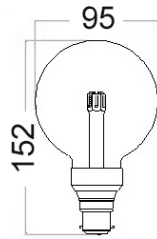

- Input voltage range: 90-264V AC 50/60Hz
- Housing & heat sink: aluminium
- Diffuser: frosted glass
- LED chips: 21pcs 2835
- Power factor: ≥ 0.5
- Ambient temperature: -15 to 40°C
- Not suitable for dimming
- Suitable for use with sensors



Part No.	Description	Base	Kelvin	Lumens	Watt	CRI	Dimensions	Carton QTY
G956	GLOBE LED ES G95 6W FR 3000K 300D	E27	3000K	590LM	6=40W	80	Ø95x152mm	1/40
G957	GLOBE LED BC G95 6W FR 5000K 300D	B22	5000K	620LM	6=40W	80	Ø95x152mm	1/40
G958	GLOBE LED ES G95 6W FR 5000K 300D	E27	5000K	620LM	6=40W	80	Ø95x152mm	1/40

G125 LED Filament Globes (8W) Globes - LED Globes

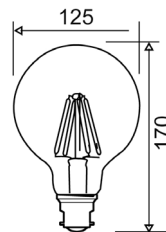

- LED filament G125 dimmable globes
- Input Voltage range: 180-260V AC 50/60Hz
- Diffuser: clear glass
- LED chips: 4x24pcs 5131JC
- Power factor: > 0.7
- Ambient temperature: -20 to 50°C
- Suitable for dimming
- Suitable for 2-way switching
- Suitable for use with PIR or Microwave sensors



Tested & Recommended Dimmers:

Brand	Part No.
CLA	VELA
LEGRAND	Cat AR400A3PM
CLIPSAL	32ELEDM, 32E450TM, 31E2RUDM, 32E450UDM
DIGINET	MEDM

Part No.	Description	Base	Kelvin	Lumens	Watt	CRI	Dimensions	Carton QTY
CF22DIM	GLOBE LED CARBON LOOK BC G125 8W	B22	2700K	800LM	8=75W	> 80	Ø125x170mm	1/50
CF23DIM	GLOBE LED CARBON LOOK BC G125 8W	B22	6000K	800LM	8=75W	> 80	Ø125x170mm	1/50
CF24DIM	GLOBE LED CARBON LOOK ES G125 8W	E27	2700K	800LM	8=75W	> 80	Ø125x170mm	1/50
CF25DIM	GLOBE LED CARBON LOOK ES G125 8W	E27	6000K	800LM	8=75W	> 80	Ø125x170mm	1/50

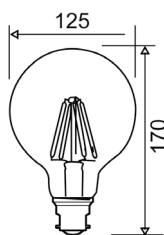

- LED filament G125 dimmable globes
- Input Voltage range: 180-260V AC 50/60Hz
- Diffuser: frosted glass
- LED chips: 4x24pcs 5131JC
- Power factor: >0.7
- Ambient temperature: -20 to 50°C
- Suitable for dimming
- Suitable for 2-way switching
- Suitable for use with PIR or Microwave sensors

25,000hr Lifetime	360° Beam Angle	IP20 Rated	DIMMABLE	2 YEAR Replacement Warranty
-------------------	-----------------	----------------------	----------	---------------------------------------

Tested & Recommended Dimmers:

Brand	Part No.
CLA	VELA
LEGRAND	Cat AR400A3PM
CLIPSAL	32ELEDM, 32E450TM, 31E2RUDM, 32E450UDM
DIGINET	MEDM

Part No.	Description	Base	Kelvin	Lumens	Watt	CRI	Dimensions	Carton QTY
G1259	GLOBE LED BC G125 8W FR DIMM	B22	2700K	800LM	8W	>80	Ø125x175mm	1/25/50
G12510	GLOBE LED ES G125 8W FR DIMM	E27	2700K	800LM	8W	>80	Ø125x175mm	1/25/50
G12511	GLOBE LED BC G125 8W FR DIMM	B22	6000K	800LM	8W	>80	Ø125x175mm	1/25/50
G12512	GLOBE LED ES G125 8W FR DIMM	E27	6000K	800LM	8W	>80	Ø125x175mm	1/25/50

G125 LED Filament Globes (6W) Globes - LED Globes



- Input voltage range: 220-250V AC 50/60Hz
- Cap base: aluminium
- Diffuser: amber tinge/ vintage colour glass
- Power factor: ≥0.4
- Ambient temperature: -20 to 50°C
- Not suitable for dimming

30,000hr Lifetime	300° Beam Angle	IP20 Rated	3 YEAR Replacement Warranty
-------------------	-----------------	----------------------	---------------------------------------

Part No.	Description	Base	Kelvin	Lumens	Watt	CRI	Dimensions	Carton QTY
CF3A	GLOBE LED CARBON LOOK ES G125 (Amber)	E27	2200K	425lm	6=60W	80	Ø125x176mm	1/20
CF4A	GLOBE LED CARBON LOOK BC G125 (Amber)	B22	2200K	425lm	6=60W	80	Ø125x176mm	1/20

G125 LED Globes (6W) Globes - LED Globes



- Input voltage range: 90-265V AC 50/60Hz
- Housing & heat sink: aluminium
- Diffuser: clear glass
- LED chips: 21pcs 2835
- Power factor: 0.5
- Ambient temperature: -15 to 40°C
- Not suitable for dimming
- Suitable for use with sensors

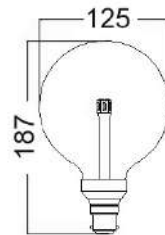
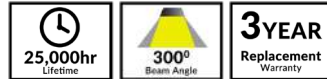

Part No.	Description	Base	Kelvin	Lumens	Watt	CRI	Dimensions	Carton QTY
G1251	GLOBE LED BC G125 6W CLR 3000K	B22	3000K	620LM	6=40W	80	Ø125x187mm	1/20
G1252	GLOBE LED ES G125 6W CLR 3000K	E27	3000K	620LM	6=40W	80	Ø125x187mm	1/20
G1253	GLOBE LED BC G125 6W CLR 5000K	B22	5000K	650LM	6=40W	80	Ø125x187mm	1/20
G1254	GLOBE LED ES G125 6W CLR 5000K	E27	5000K	650LM	6=40W	80	Ø125x187mm	1/20



- Input voltage range: 90-265V AC 50/60Hz
- Housing & heat sink: aluminium
- Diffuser: frosted glass
- LED chips: 21pcs 2835
- Power factor: 0.5
- Ambient temperature: -15 to 40°C
- Not suitable for dimming
- Suitable for use with sensors

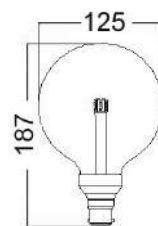
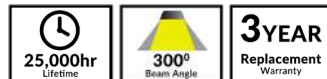

Part No.	Description	Base	Kelvin	Lumens	Watt	CRI	Dimensions	Carton QTY
G1257	GLOBE LED BC G125 6W FR 5000K	B22	5000K	620LM	6=40W	80	Ø125x187mm	1/20
G1258	GLOBE LED ES G125 6W FR 5000K	E27	5000K	620LM	6=40W	80	Ø125x187mm	1/20

Pear LED Filament Globes (8W) Globes - LED Globes

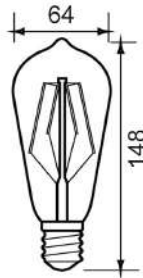

- LED filament ST64 dimmable globes
- Input Voltage range: 180-260V AC 50/60Hz
- LED chips: 4x24pcs 5131JC
- Power factor: >0.7
- Ambient temperature: -20 to 50°C
- Suitable for dimming
- Suitable for 2-way switching
- Suitable for use with PIR or Microwave sensors

25,000hr Lifetime	360° Beam Angle	IP20 Rated	DIMMABLE	2YEAR Replacement Warranty
-------------------	-----------------	----------------------	----------	--------------------------------------

Tested & Recommended Dimmers:

Brand	Part No.
CLA	VELA
LEGRAND	Cat AR400A3PM
CLIPSAL	32ELEDM, 32E450TM, 31E2RUDM, 32E450UDM
DIGINET	MEDM

Part No.	Description	Base	Kelvin	Lumens	Watt	CRI	Dimensions	Carton QTY
CF26DIM	GLOBE LED CARBON LOOK BC ST64 8W	B22	2700K	800LM	8=75W	>80	Ø64x140mm	1/25/100
CF27DIM	GLOBE LED CARBON LOOK BC ST64 8W	B22	6000K	800LM	8=75W	>80	Ø64x140mm	1/25/100
CF28DIM	GLOBE LED CARBON LOOK E27 ST64 8W	E27	2700K	800LM	8=75W	>80	Ø64x140mm	1/25/100
CF29DIM	GLOBE LED CARBON LOOK E27 ST64 8W	E27	6000K	800LM	8=75W	>80	Ø64x140mm	1/25/100

ST57 LED Filament Globes (4W) Globes - LED Globes



- Input voltage range: 220-250V AC 50/60Hz
- Cap base: aluminium
- Diffuser: amber tinge/ vintage colour glass
- Power factor: ≥0.4
- Ambient temperature: -15 to 40°C
- Not suitable for dimming

25,000hr Lifetime	IP42 Rated	3YEAR Replacement Warranty
-------------------	----------------------	--------------------------------------

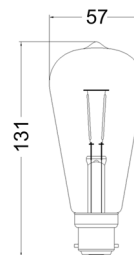

Part No.	Description	Base	Kelvin	Lumens	Watt	Beam Angle	CRI	Dimensions	Carton QTY
CF5A	GLOBE LED CARBON LOOK BC ST57	B22	2200K	380LM	4=40W	360°	80	Ø57x126mm	1/60
CF6A	GLOBE LED CARBON LOOK ES ST57	E27	2200K	380LM	4=40W	300°	80	Ø57x132mm	1/60

GLOBES

PAR38 LED Globes (15W) Globes - LED Globes



- Input voltage range: 185-265V AC 50/60Hz
- Driver input: 130mA
- Driver output: 250mA
- Housing: Aluminium & PC
- LED chips: 36pcs SMD2835 LED
- Ambient temperature: -25 to 45°C
- Not suitable for dimming
- Suitable for 2 way switching
- Suitable for use with PIR or Microwave sensors

E27	20,000hr Lifetime	60° Beam Angle	IP65 Rated	2YEAR Replacement Warranty
-----	-------------------	----------------	----------------------	--------------------------------------

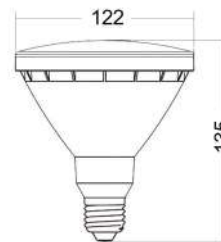

Part No.	Description	Base	Kelvin	Lumens	Watt	CRI	Dimensions	Carton QTY
SUB3	GLOBE LED ES PAR38 (White P/C) 15W	E27	3000K	1300LM	15W	>80	Ø122x135mm	1/24



- Input voltage range: 220-240V
- Diffuser & housing: plastic
- Heat sink: PBT
- LED chips: 15pcs SMD2835 LED
- Power factor: >0.5
- Ambient temperature: -20 to 40°C
- Not suitable for dimming
- Suitable for 2 way switching
- Suitable for use with sensors

E27	15,000hr Lifetime	60° Beam Angle	IP65 Rated	2YEAR Replacement Warranty
-----	-------------------	----------------	----------------------	--------------------------------------

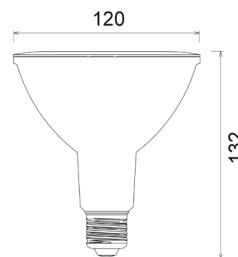

Part No.	Description	Base	Kelvin	Lumens	Watt	CRI	Dimensions	Carton QTY
PAR3802	GLOBE LED ES PAR38 15W	E27	5000K	1300LM	15W	>80	Ø120x132mm	1/10

GLOBES

PAR30 LED Globes (10W) Globes - LED Globes



Suitable for CLA SEC series security lights

- Input voltage range: 185-265V AC 50/60Hz
- Constant current driver included
- Housing: PBT, aluminium & PC
- Heat sink: PBT & aluminium
- LED chips: 10pcs SMD2835
- Power factor: ≥ 0.5
- Ambient temperature: -10 to 40°C
- Not suitable for dimming
- Suitable for 2-way switching
- Suitable for use with PIR sensor
- Suitable for CLA SEC series security lights



E27



20,000hr
Lifetime



40°
Beam Angle

IP44
Rated

2YEAR
Replacement
Warranty



Part No.	Description	Base	Kelvin	Lumens	Watt	CRI	Dimensions	Carton QTY
PAR3001	GLOBE LED ES PAR30 (Black P/C) 10W 5000K	E27	5000K	800LM	10W	80	Ø96x95mm	1/50

R63 & R80 LED Globes Globes - LED Globes

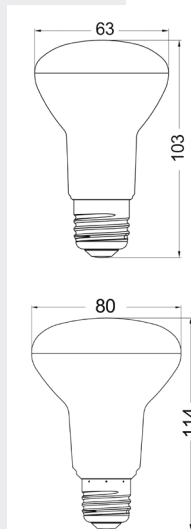

- Input voltage: 240V AC 50/60Hz
- Aluminium Heatsink with thermal conductive plastic
- Diffuser: frosted PC
- LED chips: SMD2835 LED
- Power factor: 0.5
- Ambient temperature: -20 to 55°C
- Humidity 25+- 2% ≤90%
- Not suitable for dimming



E27



15,000hr
Lifetime



105°
Beam Angle

IP20
Rated

2YEAR
Replacement
Warranty

Part No.	Description	Base	Kelvin	Lumens	Watt	CRI	LEDs	Dimensions	Carton QTY
R63L1B	GLOBE LED ES REFL FR R63	E27	3000K	640LM	8=50W	80	7pcs	Ø63x103mm	1/10/100
R63L2B	GLOBE LED ES REFL FR R63	E27	5000K	640LM	8=50W	80	7pcs	Ø63x103mm	1/10/100
R80L1B	GLOBE LED ES REFL FR R80	E27	3000K	810LM	10=65W	80	9pcs	Ø80x114mm	1/50
R80L2B	GLOBE LED ES REFL FR R80	E27	5000K	810LM	10=65W	80	9pcs	Ø80x114mm	1/50

Pilot LED Filament Globe Globes - LED Globes

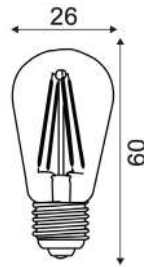

- Input voltage range: 240V AC 50/60Hz
- Housing: aluminium
- Diffuser: clear glass
- LED chips: 4pcs LED filament
- Power factor: >0.4
- Ambient temperature: -20 to 50°C
- Not suitable for use with dimmers
- Suitable for 2-way switching
- Suitable for use with PIR or microwave sensor



Part No.	Description	Base	Kelvin	Lumens	Watt	CRI	Dimensions	Carton QTY
PILOT01	GLOBE LED PILOT filament 3W 3000K ST26	E14	3000K	300LM	3W	>80	Ø26x60mm	1/25/200

T30 LED Filament Globes Globes - LED Globes



CF46DIM



CF47DIM

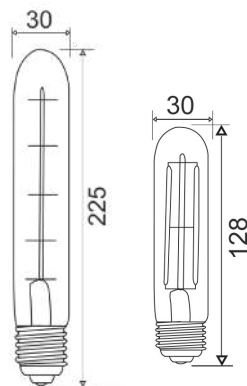

- Input voltage: 220-240V
- Material: amber glass & aluminium
- LED chips: 4x24pcs 5131JC
- Power factor: >0.7
- CRI: >80
- Ambient temperature: -20 to 50°C
- Suitable for use with dimmers
- Suitable for 2-way switching
- Suitable for use with sensors



Tested & Recommended Dimmers:

Brand	Part No.
DIGINET	MEDM
CLA	VELA
CLIPSAL	32ELEDM, 32E450TM, 31E2RUDM, 32E450UDM
LEGRAND	CAT AR400A3PM

Part No.	Description	Kelvin	Lumens	Wattage	Dimensions	Carton QTY
CF46DIM	GLOBE LED DIMM T30 filament	2700K	500LM	5W	Ø30x225mm	1/25/100
CF47DIM	GLOBE LED DIMM T30 filament	2700K	400LM	4W	Ø30x128mm	1/25/100

R7 LED Globes

Globes - LED Globes

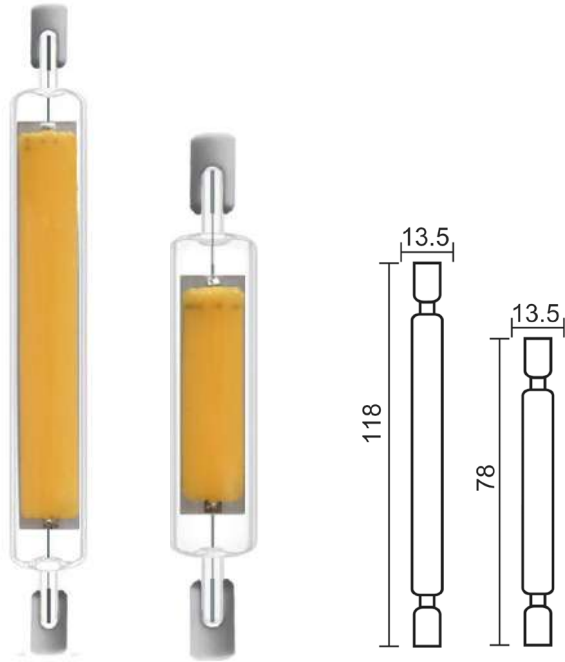

R75 & R76 R77 & R78

- LED R7S globes
- Input Voltage range: 220-240V
- Diffuser: clear glass
- Housing: glass & ceramic
- Heatsink: glass
- LED chips: 1 COB LED
- CRI: >80
- Power factor: >0.5
- Ambient temperature: -20 to 50°C
- Not suitable for dimming
- Suitable for 2 way switching & sensors



Part No.	Description	Base	Kelvin	Lumens	Watt	CRI	Dimensions	Carton QTY
R75	GLOBE LED R7 118mm 8W 3000K 360D	R7	3000K	1000LM	8W	80	Ø13.5x118mm	1/500
R76	GLOBE LED R7 118mm 8W 5000K 360D	R7	5000K	1000LM	8W	80	Ø13.5x118mm	1/500
R77	GLOBE LED R7 78mm 4W 3000K 360D	R7	3000K	400LM	4W	80	Ø13.5x78mm	1/500
R78	GLOBE LED R7 78mm 4W 5000K 360D	R7	5000K	400LM	4W	80	Ø13.5x78mm	1/500

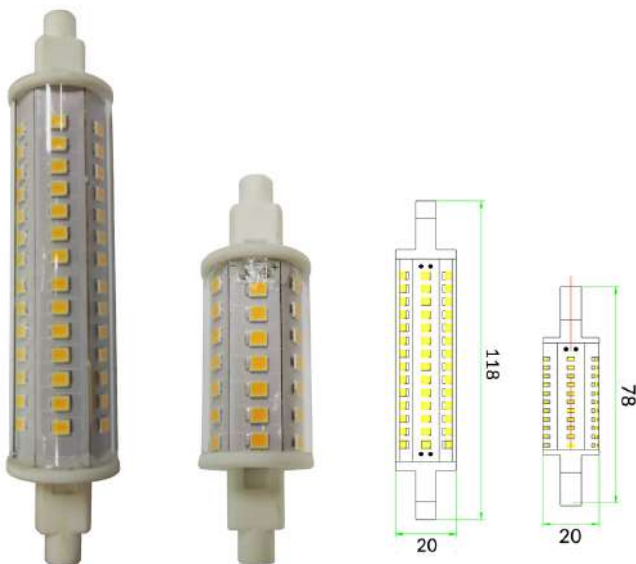

R71A & R72A R73A & R74A

- Input voltage range: 220-250V AC 50/60Hz
- Heat sink: aluminium
- LED chips: SMD2835 LED
- Power factor: ≥0.5
- Ambient temperature: -20 to 50°C
- Not suitable for dimming
- Suitable for 2 way switching
- Suitable for use with PIR sensors



Part No.	Description	Base	Kelvin	Lumens	Watt	CRI	Dimensions	Carton QTY
R71A	GLOBE LED R7 118mm 8W 3000K 360D	R7	3000K	780LM	8W	80	Ø20x118mm	1/100
R72A	GLOBE LED R7 118mm 8W 5000K 360D	R7	5000K	780LM	8W	80	Ø20x118mm	1/100
R73A	GLOBE LED R7 78mm 4W 3000K 360D	R7	3000K	500LM	4W	80	Ø20x78mm	1/200
R74A	GLOBE LED R7 78mm 4W 5000K 360D	R7	5000K	500LM	4W	80	Ø20x78mm	1/200

Spectra LED Firework Effect Globes Globes - LED Globes



SPECTRA01
(Light Off)



SPECTRA03
(Light Off)

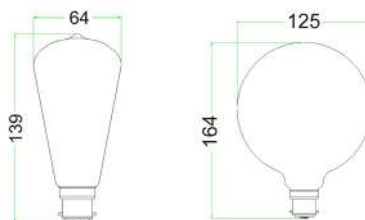

- LED firework effect decorative globes
- Input Voltage range: 220-250V AC 50/60Hz
- Power factor: ≥ 0.4
- Heat sink: aluminium
- LED chips: 42pcs SMD2835 LED
- Ambient temperature: -20 to 50°C
- Not suitable for dimming

		IP42 Rated	3YEAR Replacement Warranty
--	--	----------------------	---



Part No.	Description	Base	Lumens	Watt	CRI	Dimensions	Carton QTY
SPECTRA01	GLOBE LED Firework Effect BC ST57 PEAR 4W	B22	50LM	4W	80	Ø64x140mm	1/100
SPECTRA02	GLOBE LED Firework Effect ES ST57 PEAR 4W	E27	50LM	4W	80	Ø64x140mm	1/100
SPECTRA03	GLOBE LED Firework Effect BC G125 4W	B22	50LM	4W	80	Ø125x164mm	1/20
SPECTRA04	GLOBE LED Firework Effect ES G125 4W	E27	50LM	4W	80	Ø125x164mm	1/20

Chama LED Flame Effect Globes Globes - LED Globes



- LED decorative flame effect globes
- Input Voltage range: 100-245V AC 50/60Hz
- Heat sink: aluminium & PC
- Diffuser: opal glass
- LED chips: 99pcs SMD2835 LED
- Power factor: ≥ 0.55
- Ambient temperature: -20 to 50°C
- 3 Modes cycle with no memory retention (by turning off and on)
- Not suitable for dimming
- Suitable for 2 way switching

50,000hr
Lifetime

230°
Beam Angle

IP20
Rated

2YEAR
Replacement
Warranty

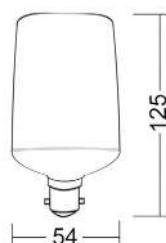

Part No.	Description	Base	Kelvin	Lumens	Watt	CRI	Dimensions	Carton QTY
CHAMA001	GLOBE LED ES FIRE 5W 3 modes	E27	1300K	150LM	5W	-	Ø54x125mm	1/20
CHAMA002	GLOBE LED BC FIRE 5W 3 modes	B22	1300K	150LM	5W	-	Ø54x125mm	1/20

Bug LED Globes Globes - LED Globes



- LED A60 anti insect repellent yellow globes
- Input voltage range: 220-240V AC 50/60Hz
- Yellow tube, insect repelling globes
- Housing & heat sink: Aluminum-plastic
- LED chips: 7pcs SMD2835 LED
- Power factor: 0.5
- Ambient temperature: -20 to 50°C
- Not suitable for dimming
- Suitable for 2 way switching
- Suitable for use with PIR or Microwave sensors

25,000hr
Lifetime

160°
Beam Angle

IP20
Rated

2YEAR
Replacement
Warranty

Part No.	Description	Base	Kelvin	Lumens	Watt	CRI	Dimensions	Carton QTY
BUG003	GLOBE LED BC GLS (A60) 7W INSECT YELLOW	B22	1500K	350LM	7W	-	Ø60x110mm	1/100
BUG004	GLOBE LED ES GLS (A60) 7W INSECT YELLOW	E27	1500K	350LM	7W	-	Ø60x113mm	1/100

3U 12V AC/DC LED Globes Globes - LED Globes



- Input voltage: 12V AC/DC 50/60Hz
- Nominal current: 1A
- Material: PBT & glass
- LED chips: 48pcs 2835 LED
- Ambient temperature: -15 to 50°C
- Not suitable for dimming
- Recommended iron core(only) transformer & Constant Voltage LED driver

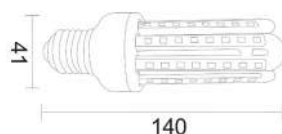

Part No.	Description	Base	Kelvin	Lumens	Watt	CRI	Dimensions	Carton QTY
3U001	GLOBE LED 12V AC/DC ES 3U 9W 3000K	E27	3000K	720LM	9W	80	Ø41x140mm	1/10/100
3U002	GLOBE LED 12V AC/DC ES 3U 9W 4000K	E27	4000K	760LM	9W	80	Ø41x140mm	1/10/100
3U003	GLOBE LED 12V AC/DC ES 3U 9W 6500K	E27	6500K	780LM	9W	80	Ø41x140mm	1/10/100

GX53 LED Globes Globes - LED Globes



- Input voltage range: 220-250V AC 50/60hz
- LED chips: 24pcs Epistar LED
- Power factor: ≥ 0.5
- Ambient temperature: -20 to 50°C
- Not suitable for dimming



Part No.	Description	Base	Kelvin	Lumens	Watt	CRI	Dimensions	Carton QTY
GX53001	GLOBE LED GX53 6W 3000K 180D	GX53	3000K	500LM	6W	80	Ø74x27mm	1/10/100
GX53002	GLOBE LED GX53 6W 5000K 180D	GX53	5000K	520LM	6W	80	Ø74x27mm	1/10/100

G4 LED Globe

Globes - LED Globes



- Input voltage: 12V AC/ DC
- Diffuser: clear silicon finish
- Housing: silicon
- Diffuser: PC
- LED chips: 1pc COB LED
- CRI: >80
- Power factor: >0.5
- Ambient temperature: -20 to 50°C
- Not suitable for dimming
- Suitable for 2-way switching
- Suitable for use with PIR sensor
- Remote AC or DC control gear required

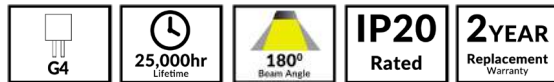

Tested & Recommended Drivers / Transformer:

CLADR12WFP, DRIV1, OTTER1, CLA111011, CLA113011, OTTER3, OTTER4, OTTER5, CLA1120011, OTTER7, ETH50.302VA (Transformer)

Part No.	Description	Base	Kelvin	Lumens	Watt	CRI	Dimensions	Carton QTY
G403	GLOBE LED 12V AC/DC G4 1.5W	G4	3000K	150LM	1.5W	>80	Ø11x40mm	100/1000



- Input voltage: 12V AC/ DC
- Material: PC
- Heatsink: ceramic
- Diffuser: PC
- LED chips: 18pcs SMD2835
- CRI: ≥ 80
- Power factor: 0.5
- Ambient temperature: -10 to 35°C
- Not suitable for dimming
- Suitable for 2-way switching
- Suitable for use with PIR sensor
- Remote AC or DC control gear required



Part No.	Description	Base	Kelvin	Lumens	Watt	CRI	Dimensions	Carton QTY
G401	GLOBE LED 12V AC/DC G4	G4	3000K	160LM	1.5W	≥80	Ø14.8x39.8mm	1/200

G9 LED Globes

Globes - LED Globes



- Input voltage: 240V AC
- LED chips: SMD2835 LED
- Power factor: >0.4
- Material: ceramic lamp holder & PC diffuser
- Ambient temperature: -20 to 50°C
- Not suitable for dimming

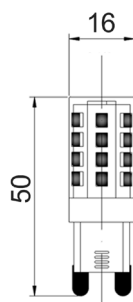

Part No.	Description	Base	Kelvin	Lumens	Watt	CRI	Dimensions	Carton QTY
G90001	GLOBE LED G9 3W 3000K 330D	G9	3000K	240LM	3W	80	Ø16x50mm	1/500
G90002	GLOBE LED G9 3W 5000K 330D	G9	5000K	270LM	3W	80	Ø16x50mm	1/500

PLC LED Globe Globes - LED Globes

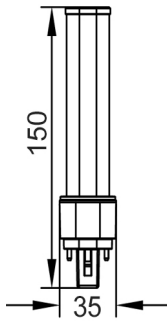

- Input voltage: 220-240V AC 50/60Hz
- Constant current LED driver inbuilt
- Housing: PC
- Heat sink: aluminium alloy
- Diffuser: PC
- LED chips: 22pcs SMD5630
- Power factor: 0.9
- CRI: 80
- Ambient temperature: -20 to 45°C
- Not suitable for dimming
- Not suitable for 2 way switching
- Not suitable for use with sensors



G24d



25,000hr
Lifetime



130°
Beam Angle

IP20
Rated

3YEAR
Replacement
Warranty

- To be used with magnetic ballast only (2 pin)
- When retrofitting luminaire with electronic ballast, bypass the electronic ballast and rewire the circuit as per the 2nd wiring example shown below.
- 3 year replacement warranty based on max.8hrs usage per day

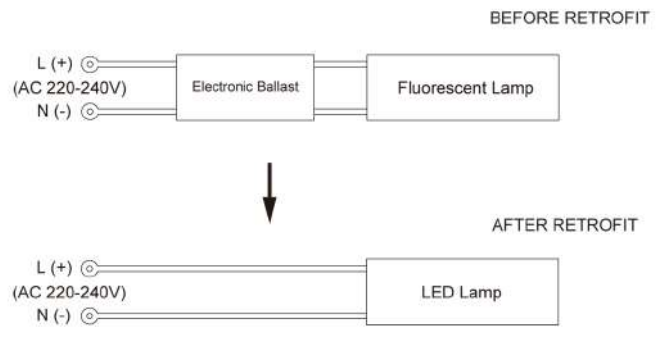

Part No.	Description	Base	Kelvin	Lumens	Watt	CRI	Dimensions	Carton QTY
PLC002	GLOBE LED PLC G24d 2 pin 8W 4000K	G24D	4000K	675LM	8W	80	53x150mm	1/10/50

GLOBES

Elliptical LED Globes Globes - LED Globes



ELLIP01-04

- LED elliptical globes
- Input voltage range: 180-240V AC 50/60Hz
- Inbuilt constant current driver included
- No control gear should be in the circuit
- Driver output voltage: 72V
- Housing: PC
- Heat sink: Die cast aluminium
- LED chips: S5 LED
- Power factor: >0.5
- Ambient temperature: -20 to 50°C
- Not suitable for dimming
- Suitable for 2-way switching
- Suitable for use with PIR or Microwave sensors

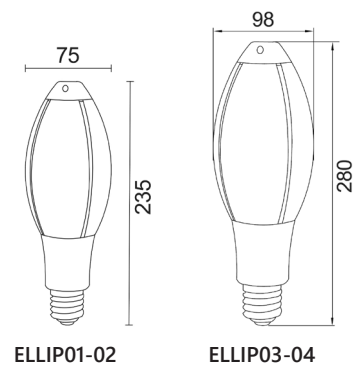

25,000hr
Lifetime

360°
Beam Angle

IP20
Rated

2YEAR
Replacement
Warranty

Part No.	Description	Base	Kelvin	Lumens	Watt	CRI	LEDs	Dimensions	Carton QTY
ELLIP01	GLOBE LED ES ELLIPTICAL 25W	E27	3000K	1700LM	25W	80	24pcs S5	Ø75x235mm	1/20
ELLIP02	GLOBE LED ES ELLIPTICAL 25W	E27	5000K	2100LM	25W	80	24pcs S5	Ø75x235mm	1/20
ELLIP03	GLOBE LED E40 ELLIPTICAL 45W	E40	3000K	3100LM	45W	80	48pcs S5	Ø98x280mm	1/10
ELLIP04	GLOBE LED E40 ELLIPTICAL 45W	E40	5000K	3800LM	45W	80	48pcs S5	Ø98x280mm	1/10

GLOBES

T8 LED Tubes

Globes - LED Globes



CCT Switch on the end



LED Starter Incl.

- T8 LED Tri-CCT tubes (4ft and 5ft)
- Input voltage: 220-240V 50/60Hz
- Inbuilt Constant Current LED driver
- Heatsink: PC
- LED chips: SMD2835 LEDs
- Tri-CCT (3000K/ 4000K/ 5700K) in one fitting
- CCT switch on the end of the tube
- **LED starter included**
- Tube base: G13
- CRI: >80
- Power factor: >0.5
- Ambient temperature: -20 to 40°C
- Not suitable for dimming
- Suitable for 2-way switching
- Suitable for use with sensors
- Double insulated

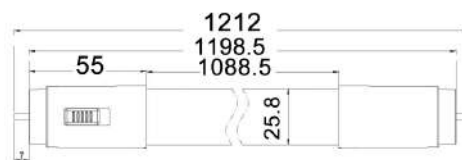

PT8TRI1 Line Drawings

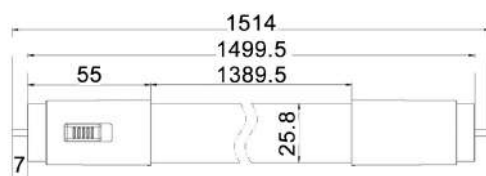
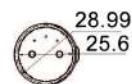

PT8TRI2 Line Drawings

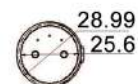

25,000hr
Lifetime

150°
Beam Angle

IP20
Rated

2YEAR
Replacement
Warranty

Part No.	Description	Lumens			Watt	CRI	PF	Length	Carton QTY
		3000K	4000K	5000K					
PT8TRI1	GLOBE LED T8 TUBE TRI 18W 4FT	1800LM	2050LM	1900LM	18W	>80	>0.5	1212mm	1/40
PT8TRI2	GLOBE LED T8 TUBE TRI 24W 5FT	2400LM	2700LM	2550LM	24W	>80	>0.5	1514mm	1/40



- Input voltage range: 220-240V AC 50/60Hz
- Heat sink: PC
- LED chips: SMD2835 LED
- Power factor: ≥ 0.9
- For indoor use only
- Ambient temperature: -20 to 40°C
- Not suitable for use with dimmers
- Suitable for 2-way switching
- Suitable for use with PIR or microwave sensor
- Warranty: please see table below



INSTALLATION INSTRUCTIONS

1. Wiring example of a single circuit luminaire with electronic ballast

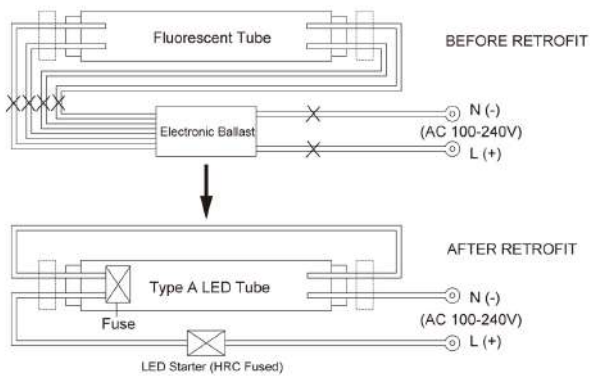

2. Wiring example of a single circuit luminaire with magnetic ballast

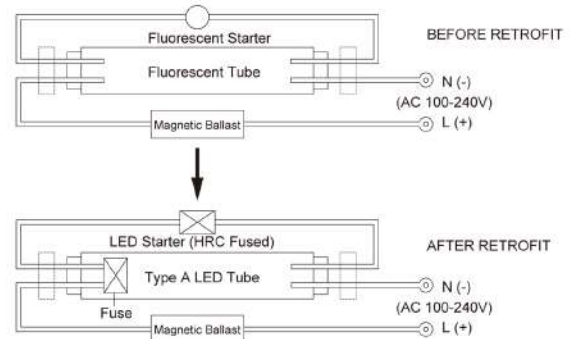

Part No.	Description	Kelvin	Lumens	Watt	CRI	Beam Angle	WTY	Dimensions	Carton QTY
PT82FT4	GLOBE LED T8 TUBE 9W 2FT	6000K	850LM	9W	80	165°	3 year	Ø28x589mm	1/25
PT818W5FT	GLOBE LED T8 TUBE 18W 5FT	3000K	1620LM	18W	80	120°	2 year	Ø28x1507mm	1/20

Oyster Conversion Kits

Globes - LED Globes



- LED Tri-CCT oyster conversion kits
- Input voltage range: 220-240V AC 50Hz
- Constant current LED driver included
- Clear diffuser: PC
- Heatsink: PCB & aluminium
- Tri-CCT (3000K/ 4000K/ 5000K) switch on driver
- LED chips: SMD2835
- Power factor: >0.8
- CRI: 80
- Not suitable for dimming
- 2 wire input
- Suitable for 2 way switching
- Suitable for use with PIR or Microwave sensors
- Ambient temperature: -20 to 45°C
- Suitable for commercial use

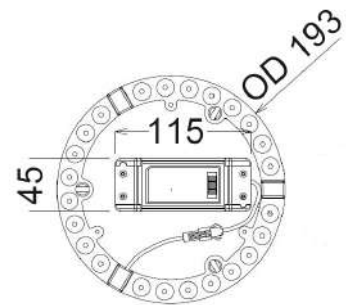

Internal Diameter: 153
CKTRI01

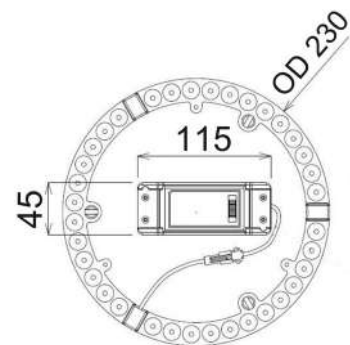

Internal Diameter: 190
CKTRI02 & CKTRI03



Part No.	Description	Lumens			Watt	CRI	Mounting Plate	Carton QTY
		3000K	4000K	5000K				
CKTRI01	GLOBE LED OYSTER CONVERSION KIT Tri-CCT	1000LM	1200LM	1150LM	12W	80	Ø193mm	1/60
CKTRI02	GLOBE LED OYSTER CONVERSION KIT Tri-CCT	1700LM	1800LM	1750LM	18W	80	Ø230mm	1/60
CKTRI03	GLOBE LED OYSTER CONVERSION KIT Tri-CCT	2150LM	2400LM	2250LM	24W	80	Ø230mm	1/60

GLOBES

Fluorescent Globes



2D Fluorescent Globes Globes - Fluorescent Globes



- 2 pin comes with integral starter
- 2 pin only suitable for use with conventional control gear
- 4 pin does not have integral starter
- 4 pin is suitable for use with high frequency electronic control gear
- 8 times the life of incandescent
- 2 pin: GR8 base
- 4 pin: GR10q base
- Not suitable for dimming



Part No.	Description	Base	Kelvin	Lumens	Watt	Dimensions	Carton QTY
2D28WGR8DL	GLOBE FL GR8 2D 2 PIN 28W 6400K	GR8	6400K	1930LM	28W	205x207mm	1/40

T5 Tube Fluorescent Globes Globes - Fluorescent Globes



- Triphosphor powder coated for 20-40% increase in light output and life
- G10q base
- 4 pins together
- Not suitable for dimming



Part No.	Description	Base	Kelvin	Lumens	Watt	Dimensions	Carton QTY
CLAT514WWW	GLOBE FL G5 T5 TUBE 14W 3000K	G5	3000K	1230LM	14W	Ø17x549mm	1/200
CLAT514WNW	GLOBE FL G5 T5 TUBE 14W 5000K	G5	5000K	1140LM	14W	Ø17x549mm	1/100

T9 Circular Fluorescent Globes Globes - Fluorescent Globes



- Triphosphor powder coated for 20-40% increase in light output and life
- G10q base
- 4 pins together
- Not suitable for dimming



Part No.	Description	Base	Kelvin	Lumens	Watt	Diam	Carton QTY
CLAFCL22WWW	GLOBE FL G10Q T9 CIRC 22W TRIPHOS	G10Q	3000K	1250LM	22W	Ø209mm	1/20
CLAFCL22WNW	GLOBE FL G10Q T9 CIRC 22W TRIPHOS	G10Q	5000K	1250LM	22W	Ø209mm	1/20
CLAFCL32WCW	GLOBE FL G10Q T9 CIRC 32W TRIPHOS	G10Q	4000K	2200LM	32W	Ø307mm	1/20
CLAFCL32WDL	GLOBE FL G10Q T9 CIRC 32W TRIPHOS	G10Q	6400K	2100LM	32W	Ø307mm	1/20
CLAFCL40WWW	GLOBE FL G10Q T9 CIRC 40W TRIPHOS	G10Q	3000K	2850LM	40W	Ø400mm	1/20
CLAFCL40WCW	GLOBE FL G10Q T9 CIRC 40W TRIPHOS	G10Q	4000K	2850LM	40W	Ø400mm	1/20
CLAFCL40WNW	GLOBE FL G10Q T9 CIRC 40W TRIPHOS	G10Q	5000K	2850LM	40W	Ø400mm	1/20

PL DU Fluorescent Globes Globes - Fluorescent Globes



- 8 times the life of incandescent globes
- Excellent colour rendering
- Double U tube fluorescent
- 2 pin comes with integral starter
- 2 pin only suitable for use with conventional control gear
- Not suitable for dimming



Part No.	Description	Base	Kelvin	Lumens	Watt	Dimensions	Carton QTY
DU10WG24D1CW	GLOBE FL G24d-1 PLC 2 PIN 10W 4200K	G24d-1	4200K	630LM	10W	35x115mm	1/50
DU13WG24D1WW	GLOBE FL G24d-1 PLC 2 PIN 10W 3100K	G24d-1	3100K	880LM	13W	35x115mm	1/50
DU18WG24D2WW	GLOBE FL G24d-2 PLC 2 PIN 18W 3100K	G24d-2	3100K	1160LM	18W	35x153mm	1/100

PL DUE Fluorescent Globes Globes - Fluorescent Globes



- 8 times the life of incandescent globes
- Excellent colour rendering
- 4 pin comes with integral starter
- 4 pin is suitable for use with AC mains, DC mains, solar cell & batteries etc
- Not suitable for dimming



Part No.	Description	Base	Kelvin	Lumens	Watt	Dimensions	Carton QTY
DUE18WG24D2WW	GLOBE FL G24q-2 PLC 4 PIN 18W	G24Q-2	3100K	1180LM	18W	35x146mm	1/100
DUE26WWW4PIN	GLOBE FL G24q-3 PLC 4 PIN 26W	G24Q-3	3100K	1500LM	26W	35x168mm	1/100



GLOBES

Carbon Filament Globes

G95 Carbon Filament Globes

Globes - Carbon Filament Globes



- Decorative globes
- Input voltage range: 220-240V AC 50/60Hz
- Power factor: 1.0
- Ambient temperature: -30 to 100°C
- Suitable for dimming
- Not recommended for fan lights

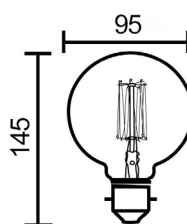

Part No.	Description	Base	Kelvin	Lumens	Watt	Dimensions	Carton QTY
CLACFA25BC	GLOBE CARBON BC G95 25W 2000K	B22	2000K	50LM	25W	Ø95x145mm	1/10/50
CLACFA25ES	GLOBE CARBON ES G95 25W 2000K	E27	2000K	50LM	25W	Ø95x145mm	1/10/50

G125 Carbon Filament Globes

Globes - Carbon Filament Globes



- Decorative globes
- Input voltage range: 220-240V AC 50/60Hz
- Power factor: 1.0
- Ambient temperature: -30 to 100°C
- Suitable for dimming
- Not recommended for fan lights

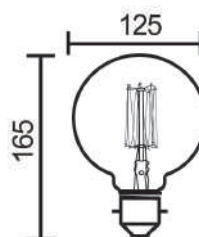

Part No.	Description	Base	Kelvin	Lumens	Watt	Dimensions	Carton QTY
CLACFB25BC	GLOBE CARBON BC G125 25W 2000K	B22	2000K	50LM	25W	Ø125x165mm	1/10/20
CLACFB25ES	GLOBE CARBON ES G125 25W 2000K	E27	2000K	50LM	25W	Ø125x165mm	1/10/20

ST57 Carbon Filament Globes Globes - Carbon Filament Globes



- Decorative globes
- Input voltage range: 220-240V AC 50/60Hz
- Power factor: 1.0
- Ambient temperature: -30 to 100°C
- Suitable for dimming
- **Not recommended for fan lights**

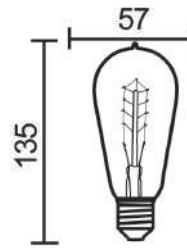

Part No.	Description	Base	Kelvin	Lumens	Watt	Dimensions	Carton QTY
CLACFC25BC	GLOBE CARBON BC ST57 25W 2000K	B22	2000K	50LM	25W	Ø57x135mm	1/10/50
CLACFC25ES	GLOBE CARBON ES ST57 25W 2000K	E27	2000K	50LM	25W	Ø57x135mm	1/10/50

T45 Carbon Filament Globes Globes - Carbon Filament Globes



- Decorative globes
- Input voltage range: 220-240V AC 50/60Hz
- Power factor: 1.0
- Ambient temperature: -30 to 100°C
- Suitable for dimming
- **Not recommended for fan lights**

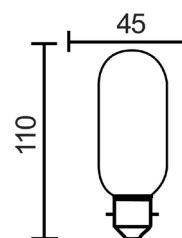

Part No.	Description	Base	Kelvin	Lumens	Watt	Dimensions	Carton QTY
CLACFD25BC	GLOBE CARBON BC T45 25W 2000K	B22	2000K	50LM	25W	Ø45x110mm	1/10/100
CLACFD25ES	GLOBE CARBON ES T45 25W 2000K	E27	2000K	50LM	25W	Ø45x110mm	1/10/100

T9 Carbon Filament Globes

Globes - Carbon Filament Globes



- Decorative globes
- Input voltage range: 220-240V AC 50/60Hz
- Power factor: 1.0
- Ambient temperature: -30 to 100°C
- Suitable for dimming
- **Not recommended for fan lights**

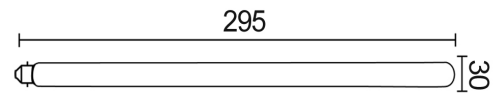

Part No.	Description	Base	Kelvin	Lumens	Watt	Dimensions	Carton QTY
CLACFE25BC	GLOBE CARBON BC T9 25W 2000K	B22	2000K	50LM	25W	Ø29x178mm	1/10/100
CLACFE25ES	GLOBE CARBON ES T9 25W 2000K	E27	2000K	50LM	25W	Ø29x178mm	1/10/100



- Decorative globes
- Input voltage range: 220-240V AC 50/60Hz
- Power factor: 1.0
- Ambient temperature: -30 to 100°C
- Suitable for dimming
- **Not recommended for fan lights**

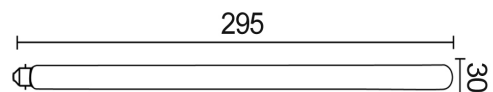

Part No.	Description	Base	Kelvin	Lumens	Watt	Dimensions	Carton QTY
CLACFF25BC	GLOBE CARBON BC T9 25W 2000K	B22	2000K	50LM	25W	Ø30x295mm	1/10/100
CLACFF25ES	GLOBE CARBON ES T9 25W 2000K	E27	2000K	50LM	25W	Ø30x295mm	1/10/100

GLOBES



GLOBES

Heat Lamp Globes

Heat Lamp Globes

Globes - Heat Lamp Globes



- Input voltage range: 220-240V AC 50/60Hz
- Power factor: 1.0
- Only available in E27 base
- Suitable for use in bathroom
- Suitable for dimming



Part No.	Description	Base	Kelvin	Lumens	Watt	Dimensions	Carton QTY
CL AHL150W	GLOBE REFL ES HEAT/L 150W 2300K	E27	2300K	800LM	150W	Ø125x185mm	1/10
CL AHL275W	GLOBE REFL ES HEAT/L 275W 2800K	E27	2800K	1800LM	275W	Ø125x185mm	1/40

ACCESSORIES

Electrical Accessories



Cluster Accessories - Electrical Accessories



CLUSTER1
(White)



CLUSTER2
(Black)



CLUSTER3
(White)

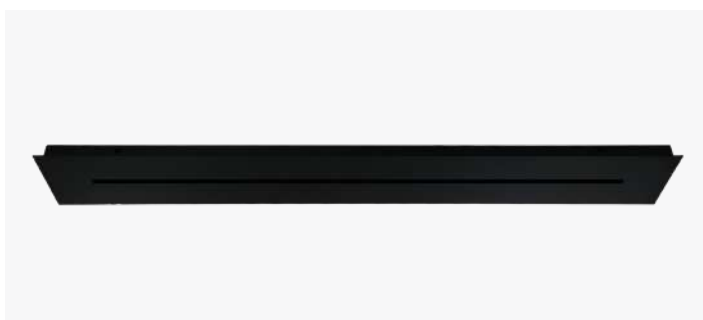

CLUSTER4
(Black)



- Cluster pendant canopies
- Available in 2 designs: Round (Max.6 lights) & Rectangular (Max.11 lights)
- Colour: Matt black / matt white
- Material: iron
- Surface mounted (Mounting bracket included)

IP20
Rated

1 YEAR
Replacement
Warranty

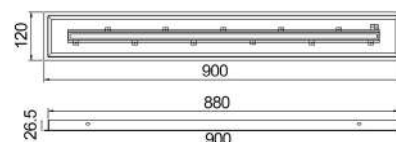
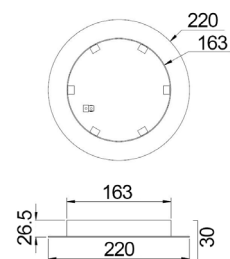

Part No.	Description	Dimensions	Carton QTY
CLUSTER1	RND Surface Mounted Cluster Canopy 6 Lights White	Ø220x26.5mm	1/10
CLUSTER2	RND Surface Mounted Cluster Canopy 6 Lights Black	Ø220x26.5mm	1/10
CLUSTER3	RECT Surface Mounted Cluster Canopy 11 Lights White	900x120x26.5mm	1/10
CLUSTER4	RECT Surface Mounted Cluster Canopy 11 Lights Black	900x120x26.5mm	1/10



LYNX1

- Fits Australian standard wall switch plate apertures (eg. the trader ranges, plus HPM, Legrand and Clipsal ranges)
- Separately switched 2-wire design-no neutral wire connection required for wall plate retrofit installation
- Inbuilt overload protection and short circuit protection
- Incorporates a thermal fuse
- Rotary control
- Protected against damage from connection to incompatible inductive load types (ig. motor loads), via conduction angle wind-back
- Complies with all relevant Australian standards
- "Soft-start" help prolong lamp and driver life
- Rated power: 300W
- Operating temperature: 0 to 35°C

Product Application:

- Can directly replace the existing wall switch to adjust dimmable LED lamp, halogen lamp and dimmable CFL.
- Suitable for public places such as family bedroom. apartment, hotel, and hospital and so on.



Part No.	LYNX1	
Operating Voltage	220-240V 50Hz	
Max.Current	1.25A	
Rated Power	300W	
Load Range	Incandescent lamp	15-300W
	LED lamp	3-200W
	halogen lamp	15-300W
	Low voltage halogen lamp with electronic transformer	3-200W
	CFL - fewer than 5pcs	3-200W
	Electric resistive heat	15-300W
Power Supply	Live wire	
Operating Temperature	0 to 35°C	
Operating Humidity	10% R.H. - 90% R.H.	
Size	L23.7mm x W23.7mm x H60mm	
Application	Indoor	
Product Configuration	<ol style="list-style-type: none"> 1. This product can adjust the brightness of the lamp through the rotary. 2. This product has over temperature, over current and short circuit protection functions. 	
Product application	<ol style="list-style-type: none"> 1. Can directly replace the existing wall switch to adjust dimmable LED lamp, halogen lamp and dimmable CFL. 2. Suitable for public places such as family bedroom. apartment, hotel, and hospital and so on. 	

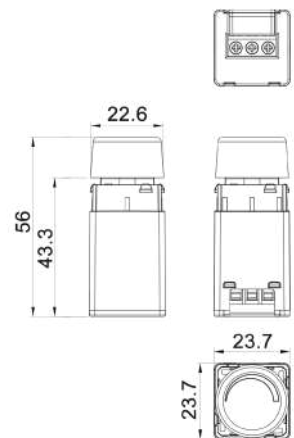



VELA

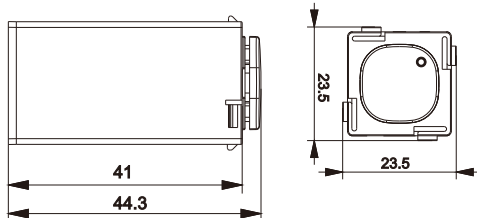

- Push button LED trailing dimmer
- Soft start
- Overload protection & short circuit protection
- Easy to mount in most Australian plates
- Suitable for dimming dimmable LED globes, incandescent globes, high voltage halogen globes, electronic transformers with low voltage halogen globes
- Long press dimming button to dim
- Short press dimming button to on/off
- Comes with 2 face caps round & square edged to suit most Australian plates



Programming:

Minimum brightness setting

- (1) Remove the top cap
- (2) Long press programming button until LED flashes slowly
- (3) Long press dimming button to set level
- (4) Double press dimming button to exit programming mode

Maximum brightness setting

- (1) Remove the top cap
- (2) Long press programming button until LED flashes, short press programming button, until LED starts to flash fast
- (3) Long press dimming button to set level
- (4) Double press dimming button to exit program mode

Technical Data:

Part No.	VELA
Nominal Operating Voltage	220-240V
Nominal Operating Frequency	50Hz
Maximum Load	350VA
Minimum Load	10VA
Dimming Technique	Trailing Edge Phase Control
Mounting Centres	84mm Australian Pattern Plate
Safety Compliance	AS/NZS 3100, AS/NZS 3133, IEC 60669-2-1
EMC Compliance	AS/NZS CISPR15, IEC 60669-2-1 (26.1, 26.2), IEC 61000-3-2 (Excepting when used in conjunction with Electronic loads)
Specifications Typical @240V 25°C	
Suitable for Indoor Use only	
No User Serviceable Parts Inside	

Sensors Accessories - Electrical Accessories



SENS001
(White)



SENS002
(Black)

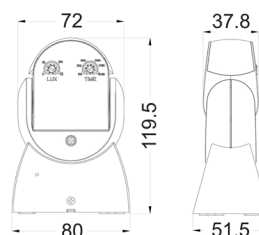

- Infrared motion surface mounted sensors
- Available in white and black fitting colour

Part No.	SENS001, SENS002
Mounting Type	Surface Mounted
Input voltage	220-240V AC 50/60Hz
Detection Range	180°
Detection Distance	12m Max (<24°C)
Detection Motion Speed	0.6-1.5m/s
Rated Load	1200W HAL/ 300W CFL/ 300W LED
Time Delay	Min.10sec+3sec Max.15min±2min (Restarts from last movement)
Ambient Light	<3-2000lux (adjustable)
Ambient Temp	-20 to +40°C
Working Humidity	<93%RH
Power Consumption	approx 0.5W
Installation Height	1.8-2.5m
Housing Material	PC
UV Resistant	Yes
3 Wire	Yes
Day/ Night Recognition	Yes
Manual Override	Yes (1) To operate as a light only (i.e. override sensor), turn power off for 3 seconds and then back on (2) To reverse the override function (i.e. re-introduce the use of the sensor), turn power off for 10 seconds and then back on

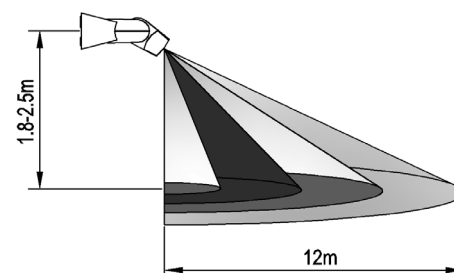

Height of installation: 1.8-2.5m

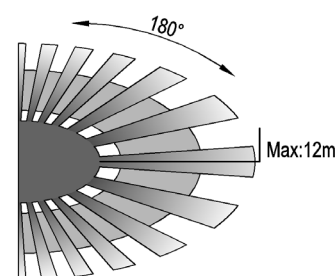

Detection Distance: Max.12m

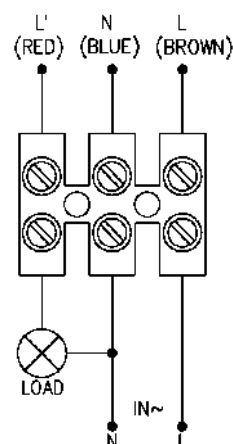



SENS003
(White)

- Infrared motion recessed sensor

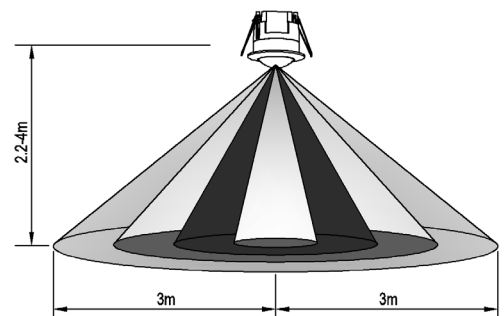
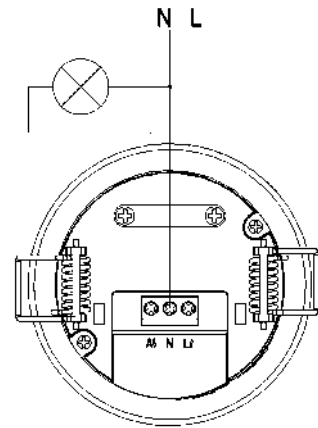
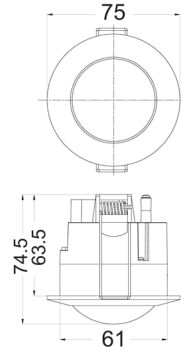

Height of installation: 2.2-4m

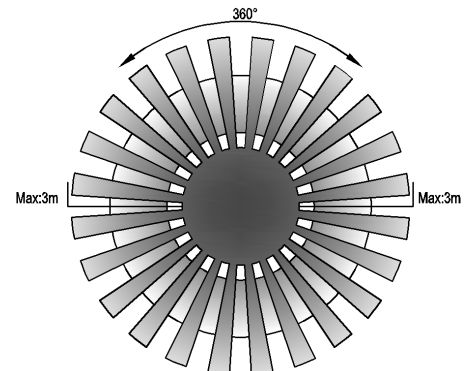

Detection Distance: Max.6m

Part No.	SENS003
Mounting Type	Recessed
Input voltage	220-240V AC 50/60Hz
Detection Range	360°
Detection Distance	6m Max (<24°C)
Detection Motion Speed	0.6-1.5m/s
Rated Load	1200W HAL/ 300W CFL / 300W LED
Time Delay	Min.10sec+3sec Max.15min+2min (restarts from last movement)
Ambient Light	<3-2000lux (adjustable)
Ambient Temp	-20 to +40°C
Working Humidity	<93%RH
Power Consumption	approx 0.5W
Installation Height	2.2-4m
Housing Material	PC
UV Resistant	Yes
3 Wire	Yes
Day/ Night Recognition	Yes
Manual Override	Yes (1) To operate as a light only (i.e. override sensor), turn power off for 3 seconds and then back on (2) To reverse the override function (i.e. re-introduce the use of the sensor), turn power off for 10 seconds and then back on





SENS004
(White)

- Infrared motion surface mounted sensor

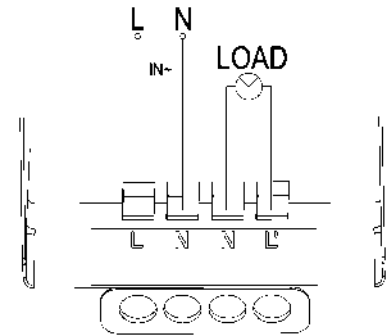
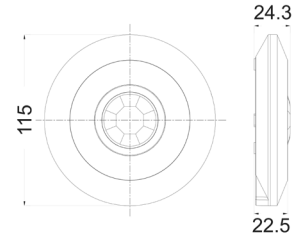

Part No.	SENS004
Mounting Type	Surface Mounted
Input voltage	220-240V AC 50/60Hz
Detection Range	360°
Detection Distance	6m Max (<24°C)
Detection Motion Speed	0.6-1.5m/s
Rated Load	2000W HAL/ 1000W CFL/ 1000W LED (If lamp higher than 60W is used the distance between lamp & sensor should be a minimum of 60cm)
Time Delay	Min.10sec±3sec Max.15min±2min (restarts from last movement)
Ambient Light	<3-2000lux (adjustable)
Ambient Temp	-20 to +40°C
Working Humidity	<93%RH
Power Consumption	approx 0.5W
Installation Height	2.2-4m
Housing Material	PC
UV Resistant	Yes
3 Wire	Yes
Day/ Night Recognition	Yes
Manual Override	Yes (1) To operate as a light only (i.e. override sensor), turn power off for 3 seconds and then back on (2) To reverse the override function (i.e. re-introduce the use of the sensor), turn power off for 10 seconds and then back on

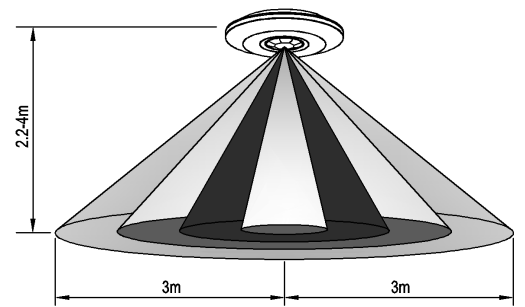

Height of installation: 2.2-4m

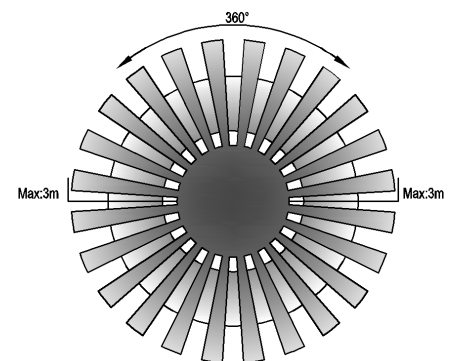

Detection Distance: Max.6m

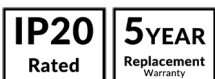



SENS005
(White)

- Infrared motion surface mounted sensor

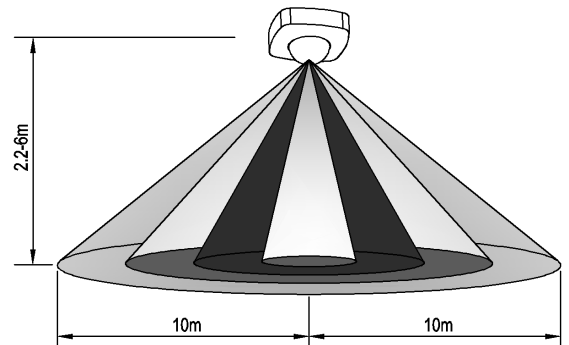
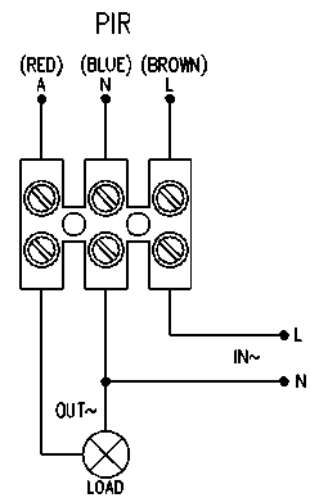
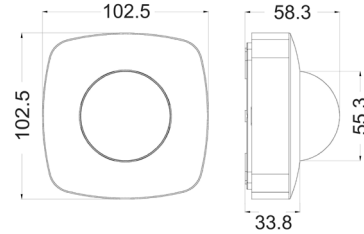

Height of installation: 2.2-6m

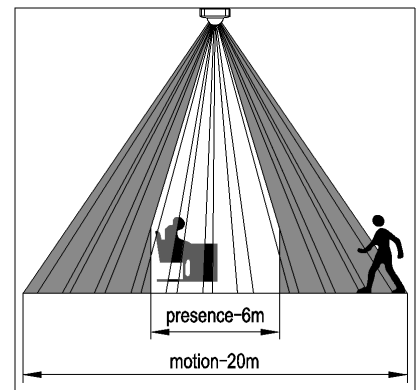

Detection Distance: Max.20m

Part No.	SENS005
Mounting Type	Surface Mounted
Input voltage	220-240V AC 50/60Hz
Detection Range	360°
Detection Distance	20m Max (<24°C)
Detection Motion Speed	0.6-1.5m/s
Rated Load	2000W HAL/ 1000W CFL/ 1000W LED
Time Delay	Min.10sec+3sec Max.30min+2min (restarts from last movement)
Ambient Light	<3-2000lux (adjustable)
Ambient Temp	-20 to +40°C
Working Humidity	<93%RH
Power Consumption	approx 0.5W
Installation Height	2.2-6m
Housing Material	PC
UV Resistant	Yes
3 Wire	Yes
Day/ Night Recognition	Yes
Manual Override	Yes (1) To operate as a light only (i.e. override sensor), turn power off for 3 seconds and then back on (2) To reverse the override function (i.e. re-introduce the use of the sensor), turn power off for 10 seconds and then back on

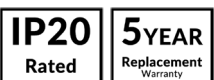



SENS007
(White)



SENS008
(Black)

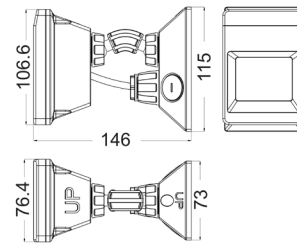

Part No.	SENS007, SENS008
Mounting Type	Surface Mounted
Input voltage	220-240V 50/60Hz
Detection Range	120°
Detection Distance	12m Max (<24°C)
Motion Detection Speed	0.6-1.5m/s
Rated Load	2000W HAL/ 1000W CFL/ 1000W LED
Time Delay	Min.10sec±3sec Max.30min±2min (restarts from last movement)
Ambient Light	3-2000Lux
Ambient Temp	-20 to 40°C
Working Humidity	<93%RH
Power Consumption	approx. 0.5W
Installation Height	1.8-2.5m
Housing Material	PC
UV Resistant	Yes
3 Wire	Yes
Day/ Night Recognition	Yes
Manual Override	Yes (1) To operate as a light only (i.e. override sensor), turn power off for 3 seconds and then back on (2) To reverse the override function (i.e. re-introduce the use of the sensor), turn power off for 10 seconds and then back on

- Adjustable infrared motion surface mounted sensors
- Available in white and black fitting colour
- Adjustable head
- New improved knuckle

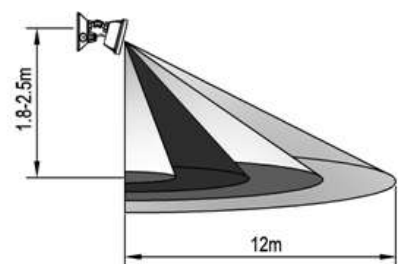
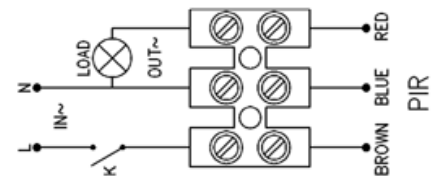

Height of installation: 1.8-2.5m

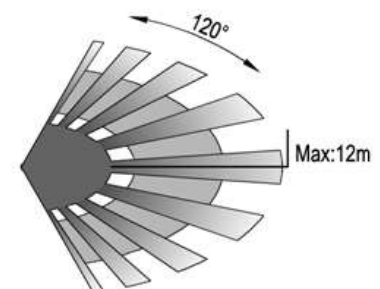

Detection Distance: Max.12m

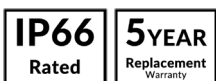



SENS009
(White)



SENS010
(Black)

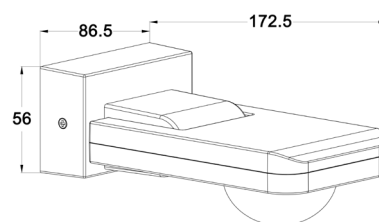

- Adjustable infrared PIR surface mounted sensors
- Available in white and black
- Adjustable head (90° up or down)

Part No.	SENS009, SENS010
Mounting Type	Surface Mounted
Input voltage	220-240V 50/60Hz
Detection Range	360°
Detection Distance	20m Max (<24°C)
Motion Detection Speed	0.6-1.5m/s
Rated Load	2000W HAL/ 1000W CFL/ 1000W LED
Time Delay	Min.10sec±3sec Max.30min±2min (restarts from last movement)
Ambient Light	3-2000Lux (adjustable)
Ambient Temp	-20 to 40°C
Working Humidity	<93%RH
Power Consumption	approx. 0.5W
Installation Height	2.2-6m
Housing Material	PC
UV Resistant	Yes
3 Wire	Yes
Day/ Night Recognition	Yes
Manual Override	Yes

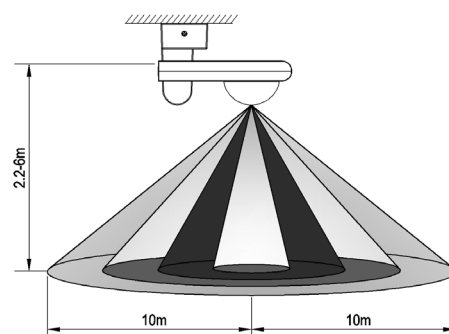
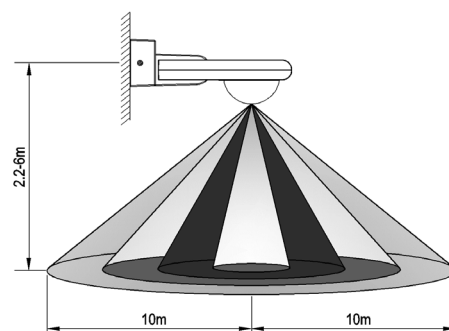

Height of Installation: 2.2-6m

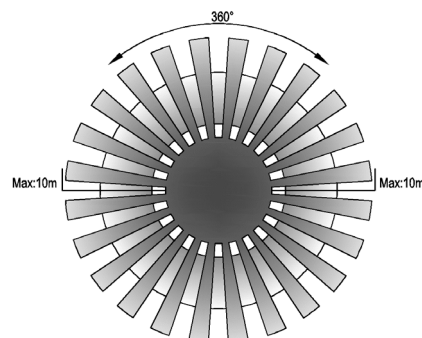

Detection Distance: Max.20m

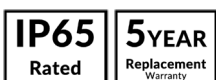



SENS011
(White)

- Microwave sensor
- To be installed inside a fitting

Part No.	SENS011
Mounting Type	To be installed inside a fitting
Input voltage	220-240V AC 50Hz
Detection Range	360°
Detection Distance	1-8m (radius) adjustable
Detection Motion Speed	0.6-1.5 m/s
Rated Load	1200W HAL/ 300W CFL/ 300W LED
Hold time	Min. 10 sec ± 3sec Max. 12 min ± 1 min
HF System	5.8 GHz CW radar, ISM band
Ambient Light	<3-2000LUX (adjustable)
Ambient Temp	-20 to 50°C
Power consumption	0.9W
Installation Height	2-6m
Housing Material	PC
IP Rating	IP20
Warranty	5 years replacement

Does not operate through metal

UV resistant

No manual override

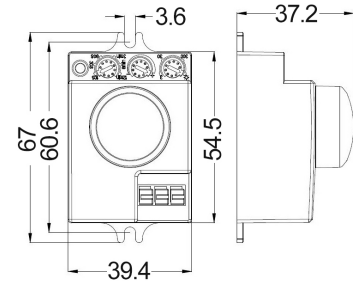
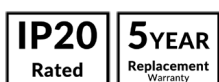

TESTING IN DAYLIGHT:

- Turn the LUX dial clockwise to MAXIMUM (sun). Turn the SENS dial clockwise to MAXIMUM (+). Turn the TIME dial anti-clockwise to MINIMUM (10s)

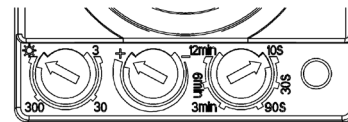

LUX SENS TIME

- Switch on the power: The light fitting will turn on and 10sec±3sec later, the light will turn off automatically. If the sensor detects movement, the light will turn on again.
- If no additional movement is detected after 10s (time pre-set in TIME dial for testing purpose), the light will turn off. If the sensor receives a new induction signal before the 10 seconds are up, the timer will restart from when the last movement was detected.

TESTING AT NIGHT:

- Turn LUX dial anti-clockwise to MINIMUM (3). If the ambient light is less than 3LUX, the light will turn on when movement detected.
- If no additional movement is detected after 10s (time pre-set in TIME dial for testing purpose), the light will turn off. If the sensor receives a new induction signal before the 10 seconds are up, the timer will restart from when the last movement was detected.

Once testing is complete, adjust the LUX, SENS and TIME dials as desired.

Connectors Accessories - Electrical Accessories



CONN003



CONN004

- Single or double cable connectors
- Construction material: Transparent PC
- Screw material: copper
- Wiring hole: 6mm
- Max.current: 32A
- CONN003: Box QTY 100pcs only
- CONN004: Box QTY 50pcs only

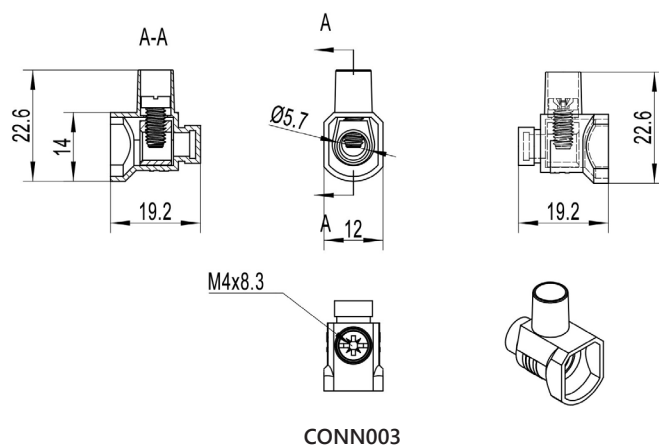

CONN003

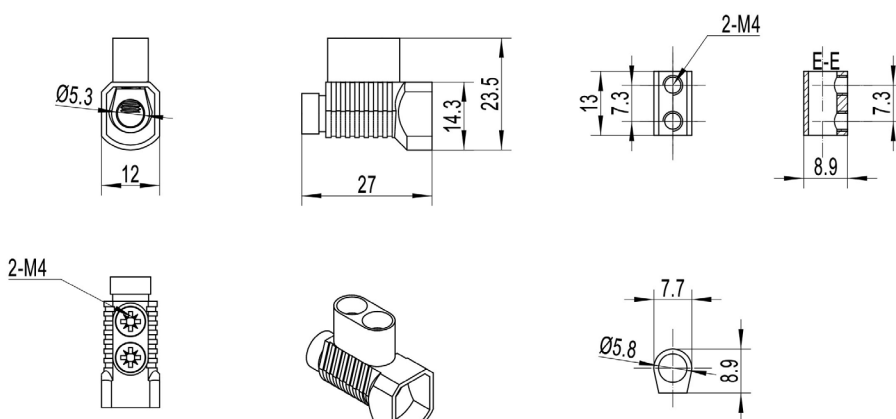

CONN004

Part No.	Description	Max. Current	Wiring Hole	Dimensions	Carton QTY
CONN003	CONNECTOR Single Cable Transparent PC with Copper	32A	1x6mm ²	19.2x12x22.6mm	100/4500
CONN004	CONNECTOR Double Cable 32A Transparent PC	32A	2x6mm ²	27x12x23.5mm	50/1250



CONN005



CONN006

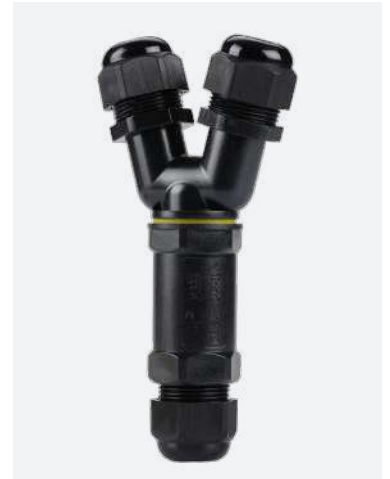

CONN007

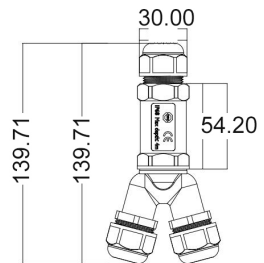
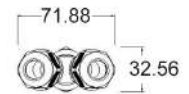
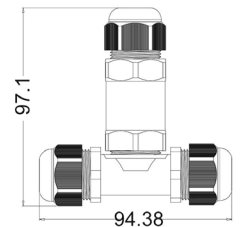

- Housing: Nylon + PC
- Conductor: Brass
- Rated Power: CONN005: 24A 450VAC; CONN006-007: 32A 450VAC
- Rated connecting capacity: CONN005: 0.5-2.5mm²; CONN006-007: 0.5-4.0mm²
- CONN005 available cable diameter (Rubber): 8-11mm
- CONN006-007 available cable diameter(Rubber): 4-8mm /8-12mm
- CONN005 Extra 8-11mm Rubbers included in the packet
- CONN006-007 Extra 8-12mm Rubbers included in the packet
- Refer to stripping length: External stripping 25mm; Internal stripping 7mm

IP68
Rated

1 YEAR
Replacement
Warranty



Part No.	Description	Max. Current	Carton QTY
CONN005	CONNECTOR / 2 Way Cable Extension Quick Connect IP68 W/PROOF BLK 24A 450VAC	24A	1/125
CONN006	CONNECTOR / 3 Way T Shape Cable Extension 3Pin Terminal IP68 W/PROOF 32A 450VAC	32A	1/125
CONN007	CONNECTOR / 3 Way Y Shape Cable Extension 3Pin Terminal IP68 W/PROOF 32A 450VAC	32A	1/125

Sockets Accessories - Electrical Accessories

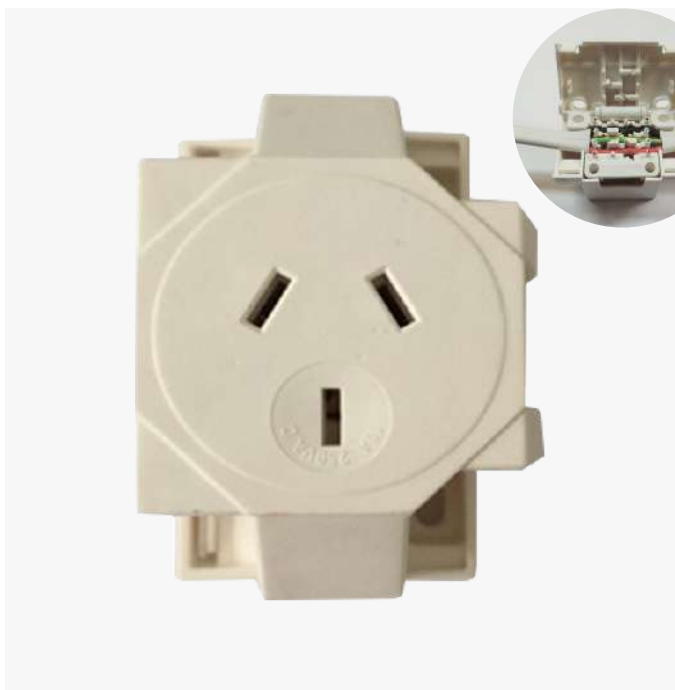

- 3-Pin quick connection surface socket
- 240V 50Hz
- Material: PC
- 10Amp current rating
- Recommended cable: 1.0mm to 2.5mm
- Product is earthed
- The cable must be stripped back first before placing cable in the socket
- Box QTY of 10pcs only

1 YEAR
Replacement
Warranty

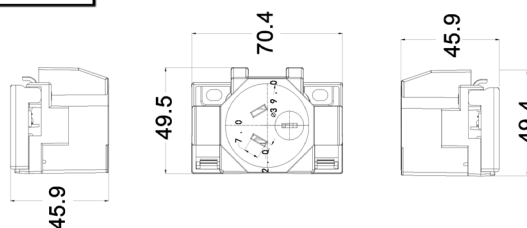

SOCK2

Part No.	Description	Carton QTY
SOCK2	SOCKET Quick Connect Single Surface 3 Pin PLUG BASE 10 Amp Earthed	1/10/200



- 3-Pin rear connecting single surface socket
- 240V/50Hz
- Material: PC
- 10Amp current rating
- Recommended cable: 1.0mm to 2.5mm
- Product is earthed
- Side entry for cable
- Polarity sensitive
- Box QTY of 10pcs only

1 YEAR
Replacement
Warranty

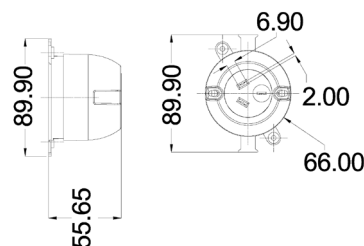

SOCK3

Part No.	Description	Carton QTY
SOCK3	SOCKET Quick Connect Single Surface 3 Pin PLUG BASE 10 Amp Earthed	1/10/200



GPO01



GPO02

- Waterproof surface sockets
- Rated voltage: 250V
- Rated current: 10A
- Inside Mech: PA66
- Outer shell: Polycarbonate
- Earthed
- For residential or general use
- IP53 rated weatherproof
- Dustproof, anti-chemical corrosion, anti-ultraviolet, anti-impact, anti-aging, anti-aging oil, anti-splash
- Can be used in gardens, outdoor areas, swimming pools or tennis courts, etc
- Numerous conduit entries
- On/off slide switch

IP53
Rated

1YEAR
Replacement
Warranty

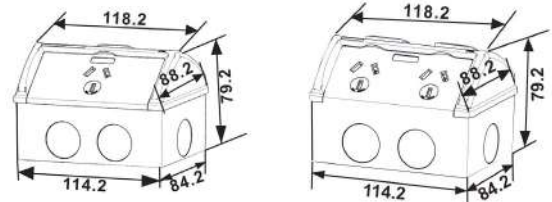

Part No.	Description	Carton QTY
GPO01	SOCKET SINGLE GPO Weatherproof 250V 10A	1/40
GPO02	SOCKET DOUBLE GPO Weatherproof 250V 10A	1/40

Batten Fixture Accessories - Electrical Accessories



BATFIX01

- 250V/50Hz
- Material: PC
- 10A current rating
- 4 terminals
- Lugs and screws included
- Box QTY of 10pcs only

1YEAR
Replacement
Warranty



Part No.	Description	Carton QTY
BATFIX01	BATTEN FIXTURE BC 10AMP 250V	10/100

Saddles Accessories - Electrical Accessories



SADDLE001 & 002



SADDLE003 & 004



SADDLE007 & 008



SADDLE005 & 006



- Stainless steel / alloy steel saddles
- SADDLE001-004 material: stainless steel 304
- SADDLE005-008 material: alloy steel
- Box QTY 100pcs only (SADDLE002: 50pcs)

Part No.	Description	Carton QTY
SADDLE001	SADDLE HALF STAINLESS STEEL 20mm 6.6mm hole	100/1K
SADDLE002	SADDLE HALF STAINLESS STEEL 25mm 5.6mm hole	50/400
SADDLE003	SADDLE FULL STAINLESS STEEL 20mm 5.6mm hole	100/1K
SADDLE004	SADDLE FULL STAINLESS STEEL 25mm 5.6mm hole	100/1K
SADDLE005	SADDLE HALF ALLOY STEEL 20mm 6.6mm hole	100/1K
SADDLE006	SADDLE HALF ALLOY STEEL 25mm 5.6mm hole	100/1K
SADDLE007	SADDLE FULL ALLOY STEEL 20mm 5.6mm hole	100/1K
SADDLE008	SADDLE FULL ALLOY STEEL 25mm 5.6mm hole	100/1K

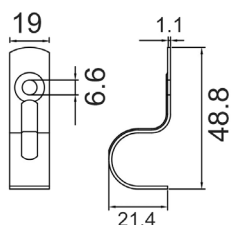

SADDLE001

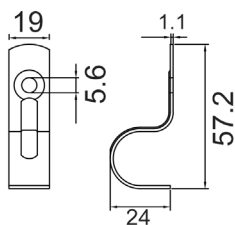

SADDLE002

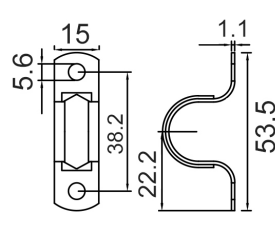

SADDLE003

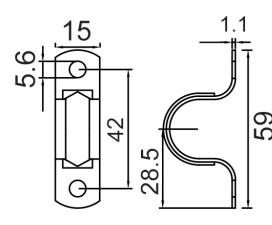

SADDLE004

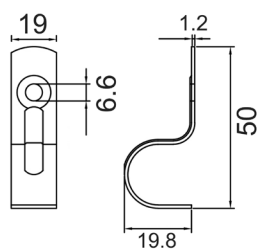

SADDLE005

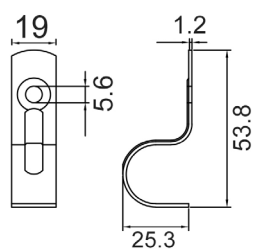

SADDLE006

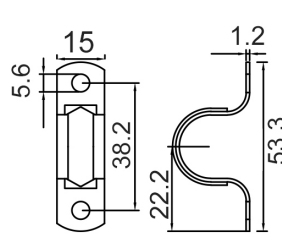

SADDLE007

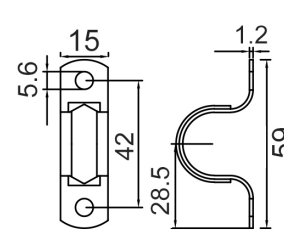

SADDLE008

Flex & Plug Accessories - Electrical Accessories



- From plug to switch 1.8m
- From switch to connection 106cm



Part No.	Description	Carton QTY
FP2WSB	FLEX & PLUG 240V POWER CORD with inline switch 2900MM BLK	1/100
FP2WSW	FLEX & PLUG 240V POWER CORD with inline switch 2900MM WH	1/100



Part No.	Description	Carton QTY
FP1.2M2W	FLEX & PLUG 240V (for 12V) (1200mm) 2 WIRE	1/100
FP2M2W	FLEX & PLUG 240V (for 12V) (2000mm) 2 WIRE	1/50
FP2M3W	FLEX & PLUG 240V (2000mm) 3 WIRE	1/50
FP2M2WWH	FLEX & PLUG 240V (for 12V) (2000mm) 2 WIRE (WHITE)	1/1
FP3M2WWH	FLEX & PLUG 240V (for 12V) (3000mm) 2 WIRE (WHITE)	1/1
FP2M3WWH	FLEX & PLUG 240V (2000mm) 3 WIRE (WHITE)	1/1
FP3M3WWH	FLEX & PLUG 240V (3000mm) 3 WIRE (WHITE)	1/1

Lamp Holder Accessories - Electrical Accessories



Part No.	Description	Carton QTY
LH0.4M	LAMPHOLDER 12V 400mm (0.40m)	1/1000
LH1.5M	LAMPHOLDER 12V 1500mm (1.50m)	1/250

Plug Accessories - Electrical Accessories



PLUG001

PLUG002

- Plugs and extension leads
- Low profile design
- Ideal for domestic use like homes or offices



Part No.	Description	Carton QTY
PLUG001	PLUG TOP Rewirable 3 PIN 10A CLEAR (Male)	1/100
PLUG002	PLUG TOP Rewirable 3 PIN 10A CLEAR (Female)	1/100

Extension Leads Accessories - Electrical Accessories



LEADB001-009



LEADW001-005

- Cable Diameter for LEADW001-005: 3x1.0mm²
- Cable Diameter for LEADB001-009: 3x1.5mm²



Part No.	Description	Carton QTY
LEADB001	EXTENSION LEAD Piggy Back Black 15A Flex / 10A Plug & Socket 1m	1/60
LEADB002	EXTENSION LEAD Piggy Back Black 15A Flex / 10A Plug & Socket 2m	1/50
LEADB003	EXTENSION LEAD Piggy Back Black 15A Flex / 10A Plug & Socket 3m	1/30
LEADB004	EXTENSION LEAD Piggy Back Black 15A Flex / 10A Plug & Socket 5m	1/20
LEADB005	EXTENSION LEAD Piggy Back Black 15A Flex / 10A Plug & Socket 10m	1/10
LEADB006	EXTENSION LEAD Piggy Back Black 15A Flex / 10A Plug & Socket 15m	1/8
LEADB007	EXTENSION LEAD Piggy Back Black 15A Flex / 10A Plug & Socket 20m	1/6
LEADB008	EXTENSION LEAD Piggy Back Black 15A Flex / 10A Plug & Socket 25m	1/6
LEADB009	EXTENSION LEAD Piggy Back Black 15A Flex / 10A Plug & Socket 30m	1/4
LEADW001	EXTENSION LEAD White 10A 2m	1/50
LEADW002	EXTENSION LEAD White 10A 3m	1/50
LEADW003	EXTENSION LEAD White 10A 5m	1/30
LEADW004	EXTENSION LEAD White 10A 7m	1/20
LEADW005	EXTENSION LEAD White 10A 10m	1/20

Power Boards Accessories - Electrical Accessories



- Available in 4 power outlets and 6 outlets
- 1m white AC cord with insulated pins
- Overload protection with test button
- Low profile design
- Ideal for home or office use



Part No.	Description	Carton QTY
CLA4PB	POWER BOARD 4 SOCKET 1000mm FP	1/48
CLA6PB	POWER BOARD 6 SOCKET 1000mm FP	1/48

ACCESSORIES

Control Gear



12V Waterproof LED Drivers (IP67) Accessories - Control Gear



- Input voltage: 170-265V 50/60Hz
- Output voltage: 12V DC
- Short Circuit, Overload and Thermal Protection
- Built in Active PFC Function
- Ambient Temperature: -30 to 50°C
- Flex & Plug Included: 1.2m

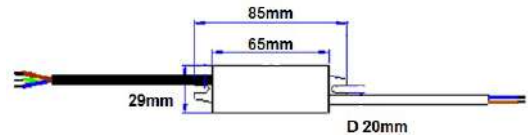

OTTER1

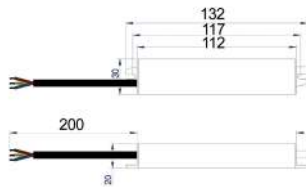

OTTER2

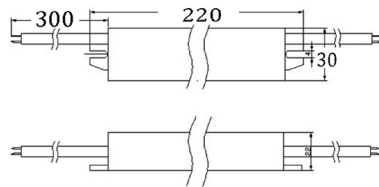

OTTER8

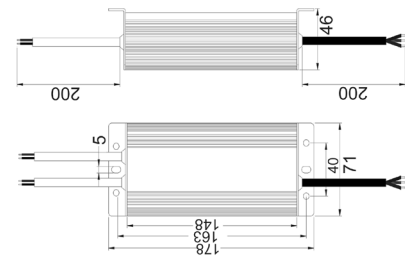

OTTER3-4

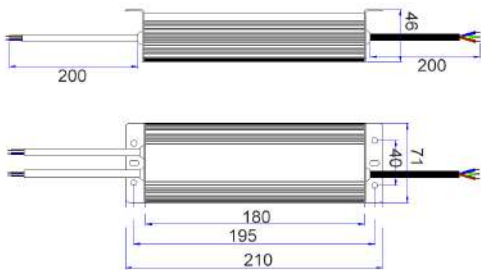

OTTER5

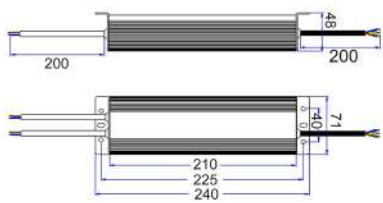

OTTER6



OTTER7

Part No.	Description	Watt	Current	Load	Min.Load Per Cable	Max.Load Per Cable	Dimensions	Carton QTY
OTTER1	DRIVER LED 12V DC	12W	0.15A	1.2-9.6W	1.2W	9.6W	65x29x20mm	1/25
OTTER2	DRIVER LED 12V DC	20W	1.67A	2-16W	2W	16W	132x30x20mm	1/25
OTTER8	DRIVER LED 12V DC	30W	2.5A	3-24W	3W	24W	182x30x20mm	1/25
OTTER3	DRIVER LED 12V DC	50W	4.17A	5-40W	5W	20W	178x71x46mm	1/10
OTTER4	DRIVER LED 12V DC	100W	8.3A	10-80W	10W	40W	178x71x46mm	1/10
OTTER5	DRIVER LED 12V DC	150W	12.5A	15-120W	15W	60W	210x71x46mm	1/10
OTTER6	DRIVER LED 12V DC	200W	16.7A	20-160W	20W	80W	240x71x48mm	1/10
OTTER7	DRIVER LED 12V DC	300W	25A	30-240W	30W	120W	275x95x50mm	1/5

For OTTER3, OTTER4, OTTER5, OTTER6 & OTTER7

These drivers are manufactured with a split cable format for carrying increased current for easier connection of multiple loads. Each driver can be used:

- At full load capacity by connecting all cables to one terminal block
- With any combination of split cables (as long as the minimum and maximum loads below are adhered to)

FULL load capacity **CANNOT** be connected to one cable

12V Waterproof LED Drivers (IP67) Accessories - Control Gear



CLA111011

- 12V DC constant voltage
- Input voltage: 170-265V AC 50/60Hz
- Output voltage: 12V DC
- Short circuit, overload, over temperature protection
- Ambient temperature: -30 to 50°C
- Flex & plug included



Part No.	Description	Watt	Load	Min. Load Per Cable	Max.Load Per Cable	Dimensions	Carton QTY
CLA111011	DRIVER LED 12V DC C/VOLTAGE 10W	10W	1-8W	1W	8W	120x29x21mm	1/100
CLA1120011	DRIVER LED 12V DC C/VOLTAGE 4x50W	200W	20-160W	5.0W	40W	235x132.2x65mm	1/100

For CLA1120011

These drivers are manufactured with a split cable format for carrying increased current for easier connection of multiple loads. Each driver can be used:

- At full load capacity by connecting all cables to one terminal block
- With any combination of split cables (as long as the minimum and maximum loads below are adhered to)

FULL load capacity CANNOT be connected to one cable

24V Waterproof LED Drivers (IP67) Accessories - Control Gear



OTTER24V1

- Output voltage: 24V DC constant voltage
- Input voltage: 240V AC 50/60Hz
- Short circuit/ Overload/ Over temp protection
- 5% excess VA should be allowed



Part No.	Description	Watt	Load	TA	TC	Length	Width	Depth	Carton QTY
OTTER24V1	DRIVER LED 24V DC C/VOLTAGE 12W	12W	1.2-9.6W	40°	80°	65mm	29mm	20mm	1/25
OTTER24V2	DRIVER LED 24V DC C/VOLTAGE 30W	30W	3-24W	40°	80°	166mm	30mm	20mm	1/25
OTTER24V3	DRIVER LED 24V DC C/VOLTAGE 100W	100W	10-80W	40°	80°	162mm	68mm	53mm	1/10
OTTER24V4	DRIVER LED 24V DC C/VOLTAGE 150W	150W	15-120W	40°	80°	215mm	68mm	53mm	1/10

12V Indoor LED Drivers (IP20) Accessories - Control Gear



DRIV1

- 12V DC constant voltage
- 1-12W output power
- Rated voltage: 240V AC 50/60Hz
- Ambient temperature: -10 to 40°C
- Short circuit protected
- Maximum distance to light source: 2m
- 5% excess VA should be allowed

IP20
Rated

2YEAR
Replacement
Warranty

Part No.	Description	Watt	Load	Dimensions	Carton QTY
DRIV1	DRIVER LED 12V DC C/VOLTAGE 1-12W	12W	1.2-9.6W	Ø55x27mm	1/100



CLADR12WFP

- 12V DC constant voltage
- 1-12W output power
- Rated voltage: 240V AC 50/60Hz
- 1Amp
- Short cut, overload, electric shock, thermal and main voltage spike protected
- Maximum distance to light source: 2m
- 20% excess VA should be allowed
- Flex & plug: 1.2m

30,000hr
Lifetime

IP20
Rated

3YEAR
Replacement
Warranty

Part No.	Description	Watt	Load	TA	TC	Dimensions	Carton QTY
CLADR12WFP	DRIVER LED 12V DC C/VOLTAGE 1-12W	12W	1.2-9.6W	50°C	75°C	42x116x27mm	1/50

ACCESSORIES

Electronic Transformer (IP65) Accessories - Control Gear



- IP65 waterproof casing
- Suitable for 12V globes
- Dimmable with leading & trailing edge control gear
- Suitable for outdoor and in ground
- Compatible with C-Bus systems
- Australian Standards Approved
- Soft start to increase globe life by 50%
- Maximum distance to light source: 2m



ETH50.302VA

Part No.	Description	Load	Dimensions	Carton QTY
ETH50.302VA	TRANSFORMER 12V AC Electronic 10-50VA IP65 W/PROOF BLK RND	10-50W	Ø47x29mm	1/100

A glowing yellow tent is pitched on a sandy beach at dusk. The tent is illuminated from within, casting a warm, golden light. In the background, a calm lake reflects the colorful sky of a sunset, with distant lights on the shore visible. The overall scene is serene and peaceful.

ACCESSORIES

Team Brand Products

Tyre Pump Team Brand Products



TP001

Part No: TP001

- Tyre pump
- Inflates 205/65R15 tyre to 40psi in 15min
- Quality screw on valve fitting
- Zip carry bag
- 2x ball and camping adaptors
- LED light and ON/OFF switch
- 110mm hose, 500mm cable
- 12V DC input
- Dimensions: 105mm x 95mm x 45mm
- Current draw: 2.5A to 6A



Smart Jump Start Charger Team Brand Products



SJS1200

Part No: SJS1200

- Smart jump start charger - Will jump start MOST vehicles up to 2.8L(2800cc) diesel or up to 6.0L(6000cc) petrol 12,000mAh (44.4Whr) Lithium polymer battery cell
- Size: L 165 x W 75 x H 35mm (Power Pack only)
- Weight: 415g (Power Pack only)
- Battery: 12V Lithium Polymer 12,000mAh (45 Whr) 3S
- Max.Current: 1200A Absolute. 500A PEAK at clamps 200A START at clamps
- Output: Jump Port 2V DC
- Device powering 12V DC up to 180W. Use SSCFCL156 Adapter (Sold separately)
- Digital Charging Ports: USB x3 / 5V 2.1A x2 / 5V 1A x1
- Battery Chargers: AS approved 240V AC/15V 1A DC. 12V DC/15V DC 1A Car Charger
- Recharge Time: 4 hrs from flat with 240V charger, 8hrs with Car charger
- Charge Indicator: Backlit LCD Display screen
- Self Discharge Rate: approx. 0.2V per month depending on ambient storage temperature
- Protection & Safety: Reverse Current , Reverse Polarity, Short Circuit, Overtemp, Overcranking, Surge, Voltage Differential, Overload Reset, Over Charge, Over Discharge
- LED Flashlight: 3 Modes (Full, S.O.S, Emergency Flash)
- Operating temperature: -20 to 60°C



Zip carry case contents:

- 12V 12,000mAh (44.4Whr) Lipo Power Pack
- Insulated Jump Start Safe Jumper Leads
- 240V AC/15V DC 1A Wall Charger
- 12V DC/15V DC 1A car charger
- USB 5V 2 in 1 Adaptor cable
- User manual and Instruction cards



SJS1500

Zip carry case contents:

- 12V 16,000mAh (60Whr) Lithium Polymer Power Pack
- Insulated Jump Start Safe Jumper Leads
- 240V AC/15V DC 1A Wall Charger
- 12V DC/15V DC 1A car charger
- USB 2 in 1 Adaptor cable
- User manual and Instruction cards



SJS1500TP

Zip carry case contents:

- 12V 16,000mAh (60Whr) Lithium Polymer Power Pack
- Insulated Jump Start Safe Jumper Leads
- 240V AC/15V DC 1A Wall Charger
- 12V DC/15V DC 1A car charger
- USB 2 in 1 Adaptor cable
- User manual and Instruction cards
- Tyre pump included

Part No: SJS1500 & SJS1500TP

- Smart jump start charger - Will jump start MOST vehicles up to 4.2L(4200cc) diesel or up to 7.0L(7000cc) petrol 16,000mAh (60Whr) Lithium polymer battery cell
- Size: L 185 x W 85 x H 38mm (Power Pack only)
- Weight: 550g (Power Pack only)
- Battery: 12V Lithium Polymer 16,000mAh (60 Whr) 3S
- Max.Current: 1500A Absolute. 600A PEAK at clamps 300A START at clamps
- Output: Jump Port 2V DC
- Device powering 12V DC up to 180watts. Use SSCFCL156 Adapter (Sold separately)
- Digital Charging Ports: USB x2 / 5V 2.1A x1 / 5V 1A x1
- Battery Chargers: AS approved 240V AC/15V 1A DC. 12V DC/15V DC 1A Car Charger
- Recharge Time: 4 hrs from flat with 240V charger, 8hrs with Car charger
- Charge Indicator: Backlit LCD Display screen
- Self Discharge Rate: approx. 0.2V per month depending on ambient storage temperature
- Protection & Safety: Reverse Current, Reverse Polarity, Short Circuit, Overtemp, Overcranking, Surge, Voltage Differential, Overload Reset, Over Charge, Over Discharge
- LED Flashlight: 3 Modes (Full, S.O.S, Emergency Flash)
- Operating temperature: -20 to 60°C
- **SJS1500TP: Tyre pump included**





Smart Jump Starters Pty Ltd



SJS3000

Zip carry case contents:

- SAA Approved 240V AC / 15V DC 2A Battery Charger
- 12V DC / 15V DC 1A Car Cigarette Lighter Charger
- Heavy Duty Jumper Leads
- EC8 to EC5 Cable Adaptor
- USB 5V 2 in 1 Adaptor Cable
- Multi Volt Digital Charging Cable and 8 Adaptors
- LED flashlight with 3 modes (ON or SOS or EMERGENCY FLASH)
- Backlit LCD Display Screen
- Ultra slim zip carry bag (365x265x70mm Complete Kit Weight 2.3kg)

Part No: SJS3000

- Smart jump start charger - Will jump start MOST vehicles up to 7.0L (7000cc) diesel or up to 10.0L (10000cc) petrol
- Battery: 12V Lithium Polymer 32,000mAh (118.4hr) 6S 2P 3.7v per cell
- Max. Current: 3000A Absolute / 1200 A PEAK at clamps / 800a START at clamp
- Output: 12V DC
- Protection for: Over discharge Protection/ Reverse Current/ Reverse Polarity/ Short circuit/ Overtemp/ Over cranking/ Surge/ Voltage Differential/ Overload Reset/ Over Charge/ Over Discharge
- Charge Time of Power Pack from flat: 4 hours for 240V Wall charger or 8 hours from Car Charger
- Suitable to Emergency Jump Start Vehicles max 7L (7000cc) Diesel or max 10L (10,000CC) Petrol Engines
- Suitable to charge 12V 2.5A / 16V 3.5A or 19V 3.5A Digital Devices
- Suitable to charge 12V DC Devices max 180W 15A when used in conjunction with EC8 to EC5 Adapter and Female Cigarette Lighter Socket (SSFCL156 sold separately)
- Suitable for use with Tyre Pump (TP001 sold separately)
- Full Recharging recommended after each use and every 6-8 weeks
- Not to be stored in areas of excessive heat where ambient temperature is above 60°C





JSSJL156

Part No.	JSSJL156
Cable	8AWG 200°C
Clamps	Insulated Copper
Forward Current	800A max.
Reverse Current	2A max. 18V max.
Battery Detection	Min.6V
Overheat Cut Out	60°C
Cool Down	Approx.3 min
Reset	Manual button
Time Out	1 min to Red flashing LED

Part No: JSSJL156

- Smart jump start charger
- STANDBY: SOLID RED LED Jumper Leads connected to Power Pack and in SHORT CIRCUIT protection mode
- BATTERY DETECTION: SOLID RED LED Jumper clamps connected to battery but vehicle battery has less than 6V. (no output) RECHARGE / REPLACE VEHICLE BATTERY
- CORRECT CONNECTION: SOLID GREEN LED Jumper clamps are connected correctly to the vehicle battery terminals. READY TO JUMP START (1min Time Out)
- INCORRECT CONNECTION: FAST RED FLASH LED Jumper leads are not connected to the vehicle battery terminals correctly (NO Output)
- OVER TEMPERATURE: SLOW GREEN FLASH LED Jumper leads are over heating from continuous cranking or over load. (NO Output) until leads cool down
- LOW VOLTAGE: FAST GREEN FLASH LED Power Pack voltage is too low for jump starting attempt. Fully charge the Power Pack. (No Output)
- VOLTAGE DIFFERENTIAL: ALTERNATE RED/ GREEN FLASH LED Vehicle Battery voltage is higher than Power Pack. (No Output)
- REVERSE CURRENT: ALTERNATE RED/GREEN FLASH LED Vehicle engine has started and is running. (No Output). Disconnect Power Pack from vehicle battery immediately.

LED Load Resistor Team Brand Products



LEDRESIST



Part No: LEDRESIST

LED Load Resistors 12V 25W 60hm (2PK)

The use of LED tail light bulbs to substitute incandescent bulbs may cause LED bulbs to increase in frequency of flash of the turn indicator, when the turn signal is initiated. To rectify this, you need to mimic the incandescent bulbs current load features. Meeting this load requirement is as simple as attaching one load resistor to each of the lamps.

LED Auto Globes Team Brand Products



LEDB242

GLOBE LED Auto BAYONET 12V 4W BA9S 6000K (2 PACK)

Wattage	4W
Kelvin	6000K
Lumens	65LM
Warranty	2 Year



LEDB264

GLOBE LED Auto BAYONET 12-24V 21W BA15S 6000K (2 PACK)

Wattage	21W
Kelvin	6000K
Lumens	420LM
Warranty	2 Year



LEDB264FY

GLOBE LED Auto BAYONET 12V 21W BAU15S AMBER 6000K (2 PACK)

Wattage	21W
Kelvin	AMBER
Lumens	360LM
Warranty	2 Year



LEDB265

GLOBE LED Auto BAYONET 12-24V 21/4W BAY15D 6000K (2 PACK)

Wattage	21/5W
Kelvin	6000K
Lumens	380LM (High-beam); 200LM (Low-beam)
Warranty	2 Year



LEDB265D

GLOBE LED Auto BAYONET 12-24V 21/5W BAZ15D 6000K (2 PACK)

Wattage	21/4W
Kelvin	6000K
Lumens	380LM (High-beam); 200LM (Low-beam)
Warranty	2 Year



LEDF271

GLOBE LED Auto FESTOON 12V 10W SV8.5 T11 6000K 36MM (2 PACK)

Wattage	10W
Kelvin	6000K
Lumens	68LM
Warranty	2 Year



LEDF272A

GLOBE LED Auto FESTOON 12V 10W SV8.5 T11 6000K 36MM (2 PACK)

Wattage	10W
Kelvin	6000K
Lumens	68LM
Warranty	2 Year



LEDF274

GLOBE LED Auto FESTOON 12V 10W SV8.5 T11 6000K 36MM (2 PACK)

Wattage	10W
Kelvin	6000K
Lumens	90LM
Warranty	2 Year



LEDW252

GLOBE LED Auto WEDGE 12V W5W T10 6000K (2 PACK)

Wattage	5W
Kelvin	6000K
Lumens	65LM
Warranty	2 Year



LEDW920

GLOBE LED Auto WEDGE 12V W5W T10 6000K (2 PACK)

Wattage	21W
Kelvin	6000K
Lumens	420LM
Warranty	2 Year



LEDW920A

GLOBE LED Auto WEDGE 12-24V 21W T20 6000K AMBER (2 PACK)

Wattage	21W
Kelvin	AMBER
Lumens	360LM
Warranty	2 Year



LEDW921

GLOBE LED Auto WEDGE 12-24V 21W T20 6000K AMBER (2 PACK)

Wattage	16W
Kelvin	6000K
Lumens	350LM
Warranty	2 Year



LEDW922

GLOBE LED Auto WEDGE 12-24V 21W T20 6000K AMBER (2 PACK)

Wattage	21/5W
Kelvin	6000K
Lumens	380LM (high-beam); 200LM (low-beam)
Warranty	2 Year



LEDW3157

GLOBE LED Auto WEDGE 12-24V 21/5W T20 6000K (2 PACK)

Wattage	21/5W
Kelvin	6000K
Lumens	380LM (high-beam); 200LM (low-beam)
Warranty	2 Year



EXECH4(H4), EXECH7(H7), EXEC9012(9012)

EXECHU1(H8, H9, H11, H16), EXECHU2(9005, 9006)

GLOBE LED Auto Easy Connect 9-24V AC 25W (2 PACK)

Wattage	25W
Kelvin	6500K
Lumens	5000LM
Warranty	2 Year

Multipurpose Microfibre Rags Team Brand Products



GRABARAG
(50 PACK)



Part No: GRABARAG

- Multipurpose microfibre automotive cleaning rags
- Portable pop-up dispenser containing 50 rags, for grab and go cleaning
- New edgeless technology finish: No scratches
- Use wet or dry, with or without chemicals
- Water absorbent 8-9 times its weight
- Pull-use-reuse



MINIGRAB
(15 PACK)



Part No: MINIGRAB

The Perfect cloth for lint free cleaning. These Industrial strength microfibre rags are washable and re-useable. Ideas for use include: interior dusting, exterior cleaning, windows and mirrors.

- Made with super absorbent terry microfibre that traps dirt and grime. Wipes down surfaces 99.9% without chemicals
- Water absorbent 8-9 times of its weight
- Machine washable on low with mild detergent. Avoid chlorine bleach or fabric softener. Tumble dry on low
- Composition: 87% polyester, 13% polyamide
- New edgeless technology finish: Gentle on surface, no scratches
- Use these rags wet or dry, with or without chemicals
- Pull-use-reuse
- Rag size: 30x23cm



Edgeless technology:
Gentle on surfaces



Effective & tough
on grime



Machine washable,
tumble dry on low



Water absorbent
8-9 times of its weight



Synthetic Chamois Cloth

Team Brand Products



BIG FELLA (60x50cm)
BARRY (40x45cm)

Part No: BARRY & BIG FELLA

- Synthetic chamois cloth
- Made in UK
- The very effective and satisfying, first-class quality, perforated synthetic chamois cloth.
- BIG FELLA: 60x50cm; BARRY: 40x45cm
- Wash before first use and wring out excess water
- Begin with drying all windows, followed by other areas of the car. If the chamois is dropped, rinse carefully to remove any impurities
- After each use, rinse chamois with clean water (by hand or machine, without any bleach) to remove dirt particles. Rinse again in clean water and then allow to dry (Machine washable at 95°C)
- Chamois remains soft when dry

Directions of Use:

- Wash before first use and wring out excess water
- Begin with drying all windows, followed by other areas of the car. If the chamois is dropped, rinse carefully to remove any impurities
- After each use, rinse chamois with clean water (by hand or machine, without any bleach) to remove dirt particles. Rinse again in clean water and then allow to dry (Machine washable at 95°C)
- Chamois remains soft when dry

Comprised of the finest material, allowing for outstanding absorbency and a supreme level of resilience, drying your vehicle with a streak free clean finish, in showroom condition!

Drying Towel

Team Brand Products



FLUFFY

Part No: FLUFFY

- The magnificent automotive drying towel
- COOPER KLEEN'S very effective, luxurious, soft and absorbent drying towel that leaves your vehicle gleaming!
- 40cm x 70cm
- Fabric density: 1000 GSM
- A splendid blend of 30% polyamide and 70% polyester
- Machine washable in cold or warm water only
- Soft and durable, scratch free edging
- Please note the actual item is yellow on both sides

Directions of Use:

After washing the vehicle, use the Cooper Kleen Drying Towel, starting with drying car windows followed by paintwork on the body of the car (top to bottom). Wring out excess water as necessary to prevent any smearing. Regularly check the towel for any dirt particles that may attach while drying to prevent possible micro-scratching.

D.I.Y. Headlight Restoration Kit

Team Brand Products



HEADLIGHTRESTKIT

Part No: HEADLIGHTRESTKIT

- DIY headlight restoration kit
- Cooper Kleen DIY Headlight Restoration Kit is designed to eliminate the worst cases of headlight degradation, yellowing, oxidation and scratches from your headlights. The kit includes everything needed to restore the cloudiest lenses and can be used without any special tools. Get great results on most plastic lenses, such as tail lights, trailers, boat windows, helmet visors, motorcycle windscreens, snowmobiles and more.
- No special tools required
- Clears headlights lens from haze and contamination
- Quick and easy 3-step process



What's included:

- P800 Sanding Disc (2)
- P1200 Sanding Disc (2)
- P2000 Sanding Disc (2)
- UV Protection Liquid 3ml (2)
- Hand Buff Tool (1)
- Wool Polish Disc (1)
- Polish Paste 85gm (1)
- White Sponge Disc (1)
- Masking Tape (1)
- Instruction Manual (1)

D.I.Y. Window Repair Kit

Team Brand Products



WINDSCREENREPKIT

Part No: WINDSCREENREPKIT

- DIY windscreen repair kit
- Cooper Kleen Windscreen Repair Kit is a handy tool designed to make repairing small chips and cracks in your windscreen a breeze in just 30 to 50 minutes. This kit will minimise the appearance of chips and cracks in your windscreen and prevent them from spreading any further. It works by removing air from the break and then fills it with a durable resin, making the area even stronger than before. To achieve the best results, repairs should be done as soon as the damage has occurred and before the break is contaminated by dirt or water.

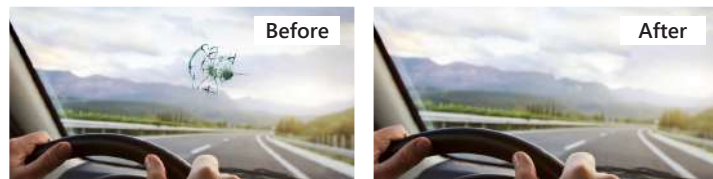

What's included

- Repair Resin (1)
- Pedestal (1)
- Razor Blade (1)
- Cleaning Cloth (1)
- Black O-ring (3)
- Rubber tube (1)
- Adhesive Seal (3)
- Curing Film (5)
- Injector with Spring Clip (1)
- Push Pin (1)
- Reflector (1)
- Instruction Manual (1)

Head Lamp Torches

Team Brand Products



SENSORHEADLIGHT



45° ADJUSTABLE ANGLE

The light source can be adjusted between 0-45° to meet various conditions of use



Part No: SENSORHEADLIGHT

- Ultra bright 5W COB LED headlamp (350LM)
- Brightness control - 3 settings: 50%, 100% & S.O.S.
- Smart on/off handwave sensor
- 45° tilt light for flexible light positioning
- Ultra lightweight design
- Adjustable headband with non-slip grip
- Rechargeable
- Battery level and charge indicator
- Micro USB charging system
- Battery: 3.7v 1400mAH Polymer Li-ion
- Operating time: 3-20 Hours
- USB charging cord included

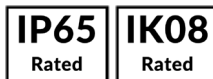

Handwave Sense On/ Off

- Easily turn the headlamp on and off by simply swiping your hand in front of the motion sensor.
- This allows you to quickly turn on the light when you need it and off when you don't.

eXelite



LIGHTHOUSE

Part No: LIGHTHOUSE

- Powerful performance rechargeable LED head lamp
- Super bright Cree P50 LED
- Function: Full beam/ Low beam/ Flash
- Wattage: 15W; Lumen: 1000lm
- Telescopic zoom design with a focusing range up to 500m
- Battery level indicator
- Built-in rapid cooling device
- Double aluminium alloy body provides optimal heat dissipation to prevent overheating
- Adjustable angle lighting: 90°
- Working time: up to 4 hours
- Micro USB rechargeable
- Micro USB charger cable included
- Batteries: 3x18650 Lithium batteries (total 6000mAh)
- Charging time: 4-5 hours
- Weight: 239g



Work Lights / Torches

Team Brand Products



LED10COUGARTCH

Part No: LED10COUGARTCH

- LED waterproof torch
- LED chips: CREE LED
- Wattage: 10W
- LED 780 Lumens brightness with 500m range
- 1x18650 Li-ion rechargeable battery
- Product size: 186 x 48 x 27mm
- Weight: 195g
- Aeronautical aluminium alloy
- Battery running time up to 1.5 hours

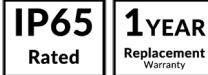

Exelite



GRAB-AND-GO

Part No: GRAB-AND-GO

- Rechargeable worklight & torch
- 2 heavy duty magnets
- Swivel hook
- Lumen output: 1200LM
- Kelvin: 6500K
- 15W COB LED
- 3.7V, 5000mAh
- Inspection sequence: 10% /50% /100% /Torch off
- SAA USB charger
- USB charging cable
- 90° angle magnet
- Material: aluminium + Polycarbonate + TPE
- IP54 ingress protection
- IK07 impact resistance
- Charging time: Lamp-5hrs; Base-7.5hrs
- Worktime: 3.5hrs (full beam)
- Battery Status indicator



Exelite



LED65WKL

Part No: LED65WKL

- Rechargeable 6+5 LED angle work light & torch
- Re-chargeable Lithium battery, 3.7V 2200mAh
- 0.3W LED + 6 x 0.5W SMD LED
- Equivalent to approximately 300 lumen
- Operating temperature: -5 to 45°C
- Working time after full charge: Approximately 3.5hr
- Charging time: Approximately 5hr
- The ambient temperature will affect the time of charging and discharging
- AC adapter: 100V-240V input, 5V 1000mA output
- Strong magnetic, adjustable angle work light



eXelite



SUPER STRONG
MAGNET BASE

BIG SLIM

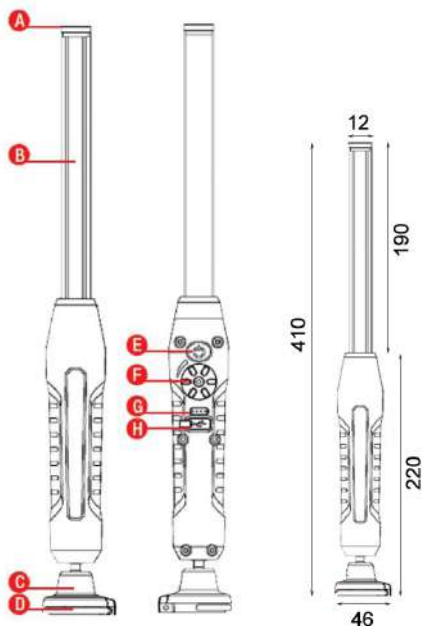

- A. TORCH LIGHT
- B. MAIN COB LIGHT
- C. 360° SWIVEL MAGNET BASE
- D. STRONG SWIVEL HOOK
- E. ON/OFF SWITCH
- F. DIMMING DIAL
- G. LED LAMP BATTERY INDICATOR
- H. MICRO USB CHARGING INPUT

Part No: BIG SLIM

- LED COB slim worklight & torch
- Dimmable 20-100%
- Rechargeable
- Super strong 360° swivel magnet base & hook
- Robust slim light
- Kelvin: 6500K
- IP67: Dust & water resistant up to 1 meter in depth protection
- IK08: Impact resistant

IP67 Rated	IK08 Rated	2YEAR Replacement Warranty
----------------------	----------------------	---

Worklight (Main COB Light):

- Ultra bright 10W COB LED
- Max.lumen: 800lm

Torch Light:

- 3W LED
- Max.lumen: 200lm

Package Includes:

- 110-240V SAA AC charger
- USB charging cable
- USB car charger

Work Time:

- Using maximum lumen: 2.5 hours
- Using minimum lumen: 20 hours

Battery:

- 3.7V 2500mAh/Li-ion Rechargeable battery
- Charging time: Approx 5 hours
- Charge the battery completely and perform to zero when using for the first time. Then fully charge again. During charging, the indicator light will flash. After charging is complete, it will stop flashing and indicator lights will be on.



eXelite



SLIM BENDY

Part No: SLIM BENDY

- 360° Rotational
- Slim and Bendy
- Dimmable (100%-10%)
- Rechargeable
- Strong Magnet at Base
- Metal hook to hang
- 5W COB LED
- Kelvin: 6500K; Lumen: 500LM
- CRI: >80
- Charging time: approximately 5 hours
- Operating time: Min: 2.45hrs on full beam; Max: 20hrs on low beam
- Torch LED on top: 2W 140LM
- Battery: 3.7V, 2500mAh Li-ion rechargeable battery



eXelite



ROCKY

Part No: ROCKY

- Heavy duty housing design/pro level
- Super strong base magnet with adjustable beam angle
- Battery capacity display
- Worklight: 1000 lumen (Dimmable)
- Torch: 200 lumen
- Charging time: Approximately 5.5 hours
- Operating time:
 - Worklight Min: 2.5hrs on 100% lumen
 - Worklight Max: 20hrs on 10% lumen
 - Torch: 12hrs
- Battery: 3.7V, 4400mAh Li-ion rechargeable battery



Worklight:
dimmable
10W, 6500K, 1000LM

Torch:
3W, 6500K, 200LM

Super strong base magnet

Adjustable Beam Angle



Worklight:

10W 6500K 1000LM
LED chip: COB
CRI: >80
Dimming range: 100%-10%

Torch:

3W LED 6500K 200LM
CRI: >80

Box Includes:

110V-240V SAA AC charger
USB charging cable
USB car charger



LITTLEKRAKKA5PK

Part No: LITTLEKRAKKA

- 12V emergency torch & work light
- Charged by cigarette lighter plug
- USB car charger adapter
- Charging voltage: 12V
- Output voltage: 5V, 2Amps
- LED chips: XPG (Torch) + COB (Work Light)
- 300 lumen (Torch); 200 lumen (Work light)
- 90° swivel head
- Torch function: Strong light, Low light, Flash light
- Work light function: Strong light
- Battery: 14500 battery, 800mAh
- Working time: up to 2.5 hours
- Include strong magnet on body
- Built in safety hammer
- Sold in 5pcs Merchandise Pack

1 YEAR
Replacement
Warranty



EXELRIPPA5PK

Part No: EXELRIPPA

- LED slim folding rechargeable work light
- LED chips: COB LED + 1PC LED
- 1 x 16340 Lithium Battery, 600mAh
- Maximum output 240 lumen
- Impact resistant 1m
- USB rechargeable
- Pocket clip
- Strong magnet at the bottom
- FUNCTION options: High light/ Low light/ Torch/ Red light/ Red flash
- Product Size: 9.5 x 3.7 x 2.6cm
- Package Weight: 77g
- COB angle adjustable
- Sold in 5pcs Merchandise Pack

2 YEAR
Replacement
Warranty

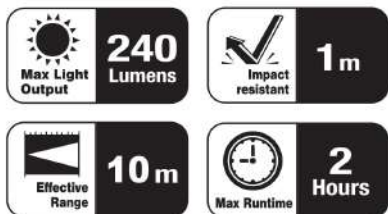

Slim light rotates 360° and swivels 180° for adjustable illumination at any angle



USB Charge



Folds for Compact Storage

eXelite



LED41WKL

Part No: LED41WKL

- Rechargeable 4+1 LED angle work light & torch
- Re-chargeable Lithium battery
- Will run for approx. 3 hours after a full charge
- Charging time approx. 5.5 hours

1 YEAR
Replacement
Warranty



TOE2530PRO

Part No: TOE2530PRO

- Rechargeable LED work light
- Cordless rechargeable
- 30pcs long life LED chips
- Colour temp: 6400K, lumens: 200lm
- Length: 350mm
- LED chips: 20,000 MCD
- 5 hours use and 5 hours charge time
- Water, oil and shock resistant IP54
- Switch on handle, swivel hanging hook
- 240V charger included
- Lamp will not operate whilst on charge
- Australian Standards Approved

50,000hr
Lifetime

IP54
Rated

1 YEAR
Replacement
Warranty

eXelite



EX-288

Part No: EX-288

- LED multi voltage 288pcs LED chips tube light
- 288pcs LED chips
- Wattage: 20W
- 1500 lumens watt efficiency
- Low power consumption 1.5Amp current draw 12V DC
- Includes 6.8m double insulated cable with IP65 joiner plug for 12V to 24V DC use (complete with cigarette plug socket and battery clamp adapter) and SAA approved driver for 240V AC use
- Smart boost design allows for full light output even on a less than fully charged battery to 9V
- 1.2m input cable with waterproof IP65 on/off switch
- Adjustable velcro straps and plastic coated hanging hooks
- Suitable for use in workshops, camping, automobile, outdoors

1 YEAR
Replacement
Warranty

eXelite



EX-10812V

Part No: EX-10812V

- LED tube light
- 12 volt cable, 12V DC
- Wattage: 8 watts, Lumens: 800 lumens
- 108 hi Intensity SMD LEDs
- Switch on handle
- Swivel hanging metal hook
- Metal swivel hook
- Australian/NZ standards approved
- Powerful wide beam
- Cigarette plug with battery adapter

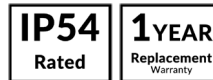

eXelite



EX-108

Part No: EX-108

- LED 108pcs 3528 LED tube light
- Wattage: 10W; Kelvin: 6700K; Lumens: 800LM
- Input voltage: 110-240V
- CRI: 80
- Twice as bright as similar 11W fluorescent
- Australian Standards Approved wall plug 240V AC driver
- Solid state lighting technology makes for much improved vibration and impact protection over fluorescent work light
- Upgraded plastic coated steel swivel hanging hook with anti-roll handle and 180 degree light beam
- IP54 water and oil resistant
- On/off switch on handle, flex & plug: 8m



Electrical Terminology

WHAT IS A KELVIN?

The kelvin is often used in the measure of the colour temperature of light sources.

Colour temperature is a characteristic of visible light that has important applications in lighting, photography, publishing, manufacturing, and other fields. The colour temperature of a light source is the temperature of an ideal black-body radiator that radiates light of comparable hue to that of the light source. Colour temperature is conventionally stated in the unit of absolute temperature, the kelvin, having the unit symbol K. Colour temperatures around 6500k are called daylight (stark white) and those around 5000k are called cool colours (natural white), while lower colour temperatures (2700-3000K) are called warm colours (warm yellow).

Deciding what kelvin to use in your home or office can be a personal choice. Most people prefer day light colours in kitchens and office work areas as this gives the appearance of a brighter white. Many people like to add warmth to their living areas by using a warmer colour. If your areas are separated, you can mix these colours. For those who are undecided, choosing a neutral (cool white colour) is the best option.

WHAT IS A LUMEN?

The lumen is the luminous flux, a measure of the power of light perceived by the human eye. Luminous flux differs from radiant flux in that luminous flux measurements (such as lumens) are intended to reflect the varying sensitivity of the human eye to different wavelengths of light, while radiant flux measurements (such as watts) indicate the total power of light emitted. The lumen is defined in relation to the candela as: $1 \text{ lm} = 1 \text{ cd}\cdot\text{sr}$.

The lumen can be thought of casually as a measure of the total "amount" of visible light in some defined beam or angle, or emitted from some source. The number of candelas or lumens from a source also depends on its spectrum, via the nominal response of the human eye as represented in the luminosity function.

The difference between the units lumen and lux is that the lux takes into account the area over which the luminous flux is spread. A flux of 1000 lumens, concentrated into an area of one square metre, lights up that square metre with an illuminance of 1000 lux. The same 1000 lumens, spread out over ten square metres, produces a dimmer illuminance of only 100 lux. Mathematically, $1 \text{ lx} = 1 \text{ lm}/\text{m}^2$.

A single fluorescent light fixture that produces a luminous flux of 12000 lumens might light a residential kitchen with an illuminance of 500 lux. Lighting a larger area to the same illuminance requires a proportionately greater number of lumens.

Lamps used for lighting are commonly labelled with their light output in lumens.

WHAT IS A LUX?

Not to be confused with a lumen, the lux is the unit of illuminance and luminous emittance measuring luminous power per area.

It is used in photometry as a measure of the intensity, as perceived by the human eye, of light that hits or passes through a surface. It is analogous to the radiometric unit watts per square metre, but with the power at each wavelength weighted according to the luminosity function, a standardized model of human visual brightness perception.

IP Rating

SOLIDS - FIRST DIGIT

The first digit indicates the level of protection that the enclosure provides against hazardous parts and the ingress of solid foreign objects

Level	Object Size Protected Against	Effective Against
0	--	No protection against contact and ingress of objects
1	>50mm	Any large surface of the body, such as the back of a hand, but no protection against deliberate contact with a body part
2	>12.5mm	Fingers or similar objects
3	>2.5mm	Tools, thick wires, etc.
4	>1mm	Most wires, screws, etc.
5	Dust Protected	Ingress of dust is not entirely prevented, but it must not enter in sufficient quantity to interfere with the satisfactory operation of the equipment; complete protection against contact
6	Dust Tight	No ingress of dust; complete protection against contact

LIQUIDS - SECOND DIGIT

Protection of the equipment inside the enclosure against harmful ingress of water.

Level	Protected against	Testing for	Details
0	Not protected	--	--
1	Dripping water	Dripping water (vertically falling drops) shall have no harmful effect.	Test duration: 10 minutes Water equivalent to 3-5mm rainfall per minute
2	Dripping water when tilted up to 15°	Vertically dripping water shall have no harmful effect when the enclosure is tilted at an angle up to 15° from its normal position.	Test duration: 10 minutes Water equivalent to 3-5mm rainfall per minute
3	Spraying water	Water falling as a spray at any angle up to 60° from the vertical shall have no harmful effect.	Test duration: 5 minutes Water Volume: 0.7 litres per minute Pressure: 80-100kNm2
4	Splashing water	Water splashing against the enclosure from any direction shall have no harmful effect.	Test duration: 5 minutes Water Volume: 10 litres per minute Pressure: 80-100kNm2
5	Water jets	Water projected by a nozzle (6.3mm) against enclosure from any direction shall have no harmful effects.	Test duration: at least 3 minutes Water volume: 12.5 litres per minute Pressure: 30kN/m2 at distance of 3meters
6	Powerful water jets	Water projected in powerful jets (12.5mm nozzle) against the enclosure from any direction shall have no harmful effects.	Test duration: at least 3 minutes Water volume: 100 litres per minute Pressure: 100kN/m2 at distance of 3meters
7	Immersion up to 1m	Ingress of water in harmful quantity shall not be possible when the enclosure is immersed in water under defined conditions of pressure and time (up to 1m of submersion)	Test duration: 30 minutes Immersion at depth of 1meter
8	Immersion beyond 1m	The equipment is suitable for continuous immersion in water under conditions which shall be specified by the manufacturer. Normally, this will mean that the equipment is hermetically sealed. However, with certain types of equipment, it can mean that water can enter but only in such a manner that produces no harmful effects.	

IK Rating

IK RATINGS

Degree of impact Protection EN62262.

IK rating system is an international classification showing degrees of protection provided by luminaires against external mechanical impacts.

Number	Measure of Protection -impact energy (joules)	Test
IK/00	No protection to this standard	
IK/01	0.15	0.20 kg impact
IK/02	0.20	0.20 kg impact
IK/03	0.35	0.2 kg impact
IK/04	0.50	0.20 kg impact
IK/05	0.70	0.20 kg impact
IK/06	1.00	0.50 kg impact from 200mm
IK/07	2.00	0.50 kg impact from 400mm
IK/08	5.00	1.70 kg impact from 295mm
IK/09	10.00	5.00 kg impact from 200mm
IK/10	20.00	5.00 kg impact from 400mm

*When higher impact energy protection is required 50 joules is recommended.

CLA Description Abbreviations Index

ABBREVIATION	EXPLANATION
A/C	Alternating Current
ANOD	Anodised Aluminium
BC	Bayonette Cap Globe Base Type (B22)
BLK	Black
CAN	Globe shape - candle
CFL	Compact Fluorescent (inbuilt ballast)
CIRC	Circular
CLR	Clear
COB	Chip On Board
COM	Commercial Use
CONN	Connectable
COP	Copper
D	Degree (Beam angle of light distribution)
D/ADJ	Double Adjustable
D/L	Recessed downlight fitting
DC	Direct Current
DIMM	Dimmable with recommended control gear
DOM	Domestic use
ES	Edison Screw Globe Base Type (E27)
F&P	Flex & plug
FL	Fluorescent (External Ballast Required)
F/RND	Globe shape - Fancy Round
FR	Frosted
HAL	Halogen
H/HOOD	Heat Hood
LB	Long Body
LED	Dedicated light Emitting Diode
LGE	Large
M/Amp	Milliamp
M/BRACKET(S)	Mounting Bracket(s)

ABBREVIATION	EXPLANATION
MED	Medium
P/C	Polycarbonate
PA	Polyamide
PL	External Ballast required/1U
PLC	External Ballast required/2U
RECD	Recessed
RECT	Rectangular
REFL	Reflector
RGB	Red/Green/Blue(multi)
RND	Round
S/ADJ	Single Adjustable
S/C	Satin Chrome
S/M	Surface Mounted
S/N	Satin Nickel
SBC	Small Bayonette Cap (B15)
SES	Small Edison Screw (E14)
SIL	Silver
SMD	Surface Mounted Diode
SML	Small
SQ	Square
SS304	Stainless Steel 304 Grade
SS316	Stainless Steel 316 Grade
T/F	Transformer (electronic)
TRIPHOS	Triphosphorous
WH	White

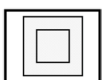

Double insulation



Dimmable

IC (Insulation Contact) Rating for Downlights IC-F (Insulation Contact-Fire Resistant)

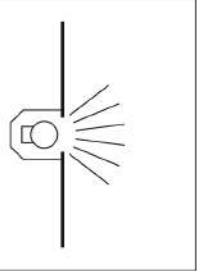
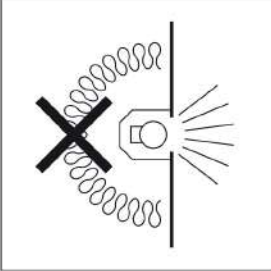
Type	Symbol	Abutted*	Normal use†—Covered	Use with insulation‡	Accessibility to high temperature parts§	Surface of luminaire normal operating temperature limit	Comments
Non-IC		No	No	No	Fully accessible	No limit on side or top surface of luminaire Mounting surface of luminaire limited to 90°C	Suitable for use in Australia and New Zealand—Intended for commercial industrial use only. Not for residential use. Not for use in residential dwellings or other places where building insulation may be installed (now or in the future). These luminaires have not been tested for use with building insulation.
Do-Not-Cover		No	No	Yes	Fully accessible	No limit on side or top surface of luminaire Mounting surface of luminaire limited to 90°C	Currently prohibited from installation in residential locations in New Zealand by AS/NZS 3000. Suitable for residential or commercial use in Australia. Cannot be covered. Manufacturer's stated clearance distances from sides of luminaire to insulation, and clearance above luminaire, will be in the installation instructions supplied with the luminaire, indicating clearances have to be observed at all times for correct installation. These luminaires have been tested to show that they are for use with building insulation present, observing manufacturer's stated installation clearance distances. They cannot be covered with building insulation, however, they have been tested to show that if inadvertently covered they should not become a fire hazard.

(continued)

IC (Insulation Contact) Rating for Downlights IC-F (Insulation Contact-Fire Resistant)

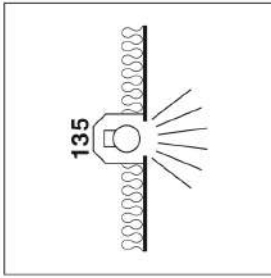
Type	Symbol	Abutted*	Normal use† — Covered	Use with insulation‡	Accessibility to high temperature parts§	Surface of luminaire normal operating temperature limit	Comments
CA90		Yes	No	Yes	Limited access In this Standard, this is assessed for access to high temperature parts by use of a 5.6 mm probe to side and top of luminaire	90°C limit on side or top or mounting surface of luminaire	Suitable for residential or commercial use in Australia and New Zealand. Cannot be covered. Insulation can be placed against the sides of the luminaire. Manufacturer's stated clearance above the luminaire will be in the instructions provided with the luminaire, indicating clearance has to be observed for correct installation. These luminaires have been tested to show that they are for use with building insulation present and placed against the sides of the luminaire. They cannot be covered in building insulation, however, they have been tested to show that if inadvertently covered they should not become a fire hazard.
CA135		Yes	No	Yes	Some access In this Standard, this is assessed for access to high temperature parts by use of a 50 mm probe to side and top of luminaire	135°C limit on side or top surface of luminaire Mounting surface of luminaire limited to 90°C	Suitable for residential or commercial use in New Zealand only. Not permitted for use in Australia. Cannot be covered. Insulation can be placed against the sides of the luminaire. Manufacturer's stated clearance above the luminaire will be in the instructions provided with the luminaire, indicating clearance has to be observed for correct installation. Cannot be used where building materials or insulation is not rated for exposure to constant temperatures of 135°C (cannot have such building material or insulation touching the sides of the luminaire). These luminaires have been tested to show that they are for use with building insulation present and placed against the sides of the luminaire. They cannot be covered in building insulation, however, they have been tested to show that if inadvertently covered they should not become a fire hazard.

(continued)

IC (Insulation Contact) Rating for Downlights IC-F (Insulation Contact-Fire Resistant)

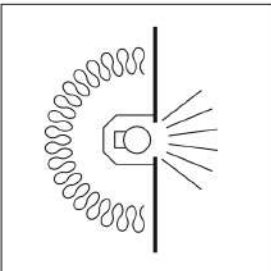
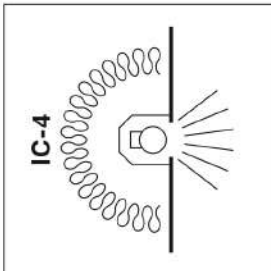
Type	Symbol	Abuttled*	Normal use†—Covered	Use with insulation‡	Accessibility to high temperature parts§	Surface of luminaire normal operating temperature limit	Comments
IC		Yes	Yes	Yes	Limited access In this Standard, this is assessed for access to high temperature parts by use of a 5.6 mm probe to sides and top of luminaire.	90°C limit on side or top or mounting surface of luminaire	Suitable for residential or commercial use in Australia and New Zealand. Used where some air transfer is allowed or desired between living space and roof space (there will be some air transfer between the spaces if the luminaire is not fully covered in insulation). These luminaires have been tested to show they are suitable for normal use when covered in building insulation.
IC-4		Yes	Yes	Yes	Restricted access In this Standard, this is assessed for access to high temperature parts by use of a IP4X—1 mm probe to sides, top and front face of luminaire.	90°C limit on side or top or mounting surface of luminaire	Suitable for residential or commercial use in Australia and New Zealand. Used where air transfer is not permitted or not desired between living space and roof space (there will be no air transfer between spaces even if there is no insulation covering the luminaire). Typical use is passive house design where no air transfer is allowed. These luminaires have been tested to show that they are suitable for normal use when covered in building insulation.

(continued)

IC (Insulation Contact) Rating for Downlights IC-F (Insulation Contact-Fire Resistant)

Type	Symbol	Abutted*	Normal use†—Covered	Use with insulation‡	Accessibility to high temperature parts§	Surface of luminaire normal operating temperature limit	Comments
No Marking		No	No	No	No		<p>Not verified as tested/compliant to Australian/New Zealand standards.</p> <p>Marking is required by standards—no marking indicates non-compliance.</p> <p>Installation instructions specifying any clearance distance is required by this Standard.</p> <p>Do not install any luminaire that does not have one of the marking symbols or instructions specifying any clearance distances.</p> <p>NOTE: For luminaires installed prior to the publication of this Standard (AS/NZS 60598.2.2:2016), which do not have marking and/or installation instructions with clearance distances specified, refer to AS/NZS 3000.</p>

* May be abutted against normally flammable building elements or insulation.

† Intended and tested for use under building insulation as part of normal operation.

‡ May be used where building insulation may be installed (now or in the future).

§ Classification and probe to determine access of insulation etc., to high temperature parts.

Index by Part Number

PART NO.	BARCODE	PAGE	PART NO.	BARCODE	PAGE
2D28WGR8DL	9326191019814	444	BATFIX01	9326191032127	467
3U001	9326191025938	435	BELLA1	9326191034398	81
3U002	9326191025945	435	BELLA2	9326191034404	81
3U003	9326191025952	435	BELLA3	9326191034411	81
A			BES1	9326191027628	244
ABBEY1	9326191030093	89	BES2	9326191027635	244
ABBEY2	9326191030109	89	BIG FELLA	9323129057399	486
AKENTRI1	9326191038082	237	BIG SLIM	9323129084838	490
AKENTRI2	9326191038099	237	BLACKBAND1	9326191018152	146
ALTA1	9326191023880	152	BLACKBAND1X3	9326191019982	148
ALTA1W	9326191025372	188	BLACKBAND2	9326191018169	146
ALTA2	9326191023897	152	BLACKBAND2X3	9326191019999	148
ALTA2W	9326191025389	188	BLACKBAND3	9326191018176	146
ALTA3	9326191023903	152	BLACKBAND4	9326191018183	146
ALTA3W	9326191025396	188	BLACKBAND5	9326191019968	147
AMUN1	9326191024740	316	BLACKBAND6	9326191019975	147
AMUN2	9326191024757	316	BOCINA01	9326191032479	240
AMUN3	9326191024764	316	BOCINA02	9326191032653	240
AMUN4	9326191024771	316	BOL1A	9326191030963	322
APIS1	9326191027697	247	BOL2A	9326191030970	322
APIS2	9326191027703	247	BOL3A	9326191030987	322
ARMIS1	9326191027475	116	BOL4A	9326191030994	322
ARMIS2	9326191027482	116	BONITO1	9326191019630	97
ARMIS3	9326191027499	116	BONITO2	9326191019647	97
ARMIS4	9326191027505	116	BONITO3	9326191019654	97
ARMIS5	9326191027512	116	BONITO6	9326191037818	97
ARMIS6	9326191027529	116	BONITO7	9326191030000	97
ARMIS7	9326191027536	116	BONITO8	9326191030017	97
ARMIS8	9326191027543	116	BORDA1	9326191036095	308
ARMIS9	9326191027550	116	BORDA2	9326191036101	308
ATEN1	9326191024887	248	BORDA3	9326191036118	308
ATEN2	9326191024894	248	BORDA4	9326191036125	308
ATHENSG2	9326191029509	199	BORDA5	9326191036132	308
ATLANTA	9326191038211	193	BORDA6	9326191036149	308
AUTUMN01	9326191029028	103	BOTANICA01A	9326191039188	51
AUTUMN02	9326191029035	103	BOTANICA02A	9326191039195	51
AUTUMN03W	9326191029042	189	BOTANICA03A	9326191039201	51
AUTUMN04TL	9326191029059	182	BRICKTRI1	9326191037344	258
B			BRICKTRI2	9326191037351	258
BAGOTA	9326191038174	194	BRICKTRI3	9326191037368	259
BANQUET1	9326191036927	24	BRICKTRI4	9326191037375	259
BARCELONA	9326191014475	199	BRIGHTON01	9326191029622	207
BARRIQUE1	9326191036903	26	BRIGHTON02	9326191029639	207
BARRIQUE2	9326191036910	26	BRISTOL	9326191038235	193
BARRY	9323129057382	486	BROTE1	9326191034930	31
BAT001	9326191037894	371	BROTE2	9326191034947	31
BAT002	9326191037900	371	BUDDY	9326191037931	174

Index by Part Number

PART NO.	BARCODE	PAGE	PART NO.	BARCODE	PAGE
BUG003	9326191010712	434	CEREMA3	9326191035807	40
BUG004	9326191010705	434	CEREMA4	9326191035814	40
BULK1	9326191015793	261	CESTA1	9326191035883	47
BULK10	9326191025242	263	CF14DIM	9326191030321	415
BULK11	9326191026706	264	CF15DIM	9326191030338	415
BULK12	9326191026713	264	CF16DIM	9326191030345	415
BULK13	9326191026683	264	CF17DIM	9326191030352	415
BULK14	9326191026690	264	CF18DIM	9326191030369	423
BULK15	9326191029455	265	CF19DIM	9326191030376	423
BULK16	9326191029448	265	CF20DIM	9326191030383	423
BULK17	9326191029479	265	CF21DIM	9326191030390	423
BULK18	9326191029462	265	CF22DIM	9326191030406	425
BULK2	9326191015809	261	CF23DIM	9326191030413	425
BULK3	9326191015816	262	CF24DIM	9326191030420	425
BULK5	9326191022203	262	CF25DIM	9326191030437	425
BULK7	9326191024320	262	CF26DIM	9326191030444	428
BULK9	9326191025235	263	CF27DIM	9326191030451	428
C			CF28DIM	9326191030468	428
CAN17	9326191018947	421	CF29DIM	9326191030475	428
CAN18	9326191018954	421	CF30DIM	9326191030482	418
CAN20	9326191018978	421	CF31DIM	9326191030499	418
CAN24	9326191019012	421	CF32DIM	9326191030505	418
CAN33D	9326191035425	421	CF33DIM	9326191030512	418
CAN34D	9326191035432	421	CF34DIM	9326191030529	418
CAN35D	9326191035449	421	CF35DIM	9326191030536	418
CAN36D	9326191035456	421	CF36DIM	9326191030543	418
CAN37D	9326191035463	421	CF37DIM	9326191030550	418
CAN38D	9326191035470	421	CF38DIM	9326191030567	420
CAN39D	9326191035487	421	CF39DIM	9326191030574	420
CAN40D	9326191035494	421	CF3A	9326191021107	426
CANAMO1	9326191035890	43	CF40DIM	9326191030581	420
CANAMO2	9326191035906	43	CF41DIM	9326191030598	420
CANASTA1	9326191035821	48	CF42DIM	9326191030604	420
CANASTA2	9326191035838	48	CF43DIM	9326191030611	420
CANNES	9326191015373	199	CF44DIM	9326191030628	420
CARDIFF	9326191038228	195	CF45DIM	9326191030635	420
CASA1	9326191018893	130	CF46DIM	9326191036279	431
CASA2	9326191018909	130	CF47DIM	9326191036286	431
CASA3	9326191018916	130	CF4A	9326191021114	426
CAVIAR4	9326191028212	158	CF5A	9326191021121	428
CAVIAR5	9326191028229	158	CF6A	9326191021138	428
CAVIAR6	9326191028236	158	CHAMA001	9326191026164	434
CELESTE1A	9326191039218	120	CHAMA002	9326191028281	434
CELESTE2A	9326191039225	120	CHAMPAN1	9326191034695	62
CELESTE3A	9326191039232	120	CHAMPAN1X3R	9326191034718	62
CEREMA1	9326191035784	40	CHAMPAN1X3S	9326191034701	62
CEREMA2	9326191035791	40	CHAMPAN2	9326191034725	62

Index by Part Number

PART NO.	BARCODE	PAGE	PART NO.	BARCODE	PAGE
CHAMPAN2X3R	9326191034749	62	CLAFCL22WWW	9326191007804	445
CHAMPAN2X3S	9326191034732	62	CLAFCL32WCW	9326191007859	445
CHAPEAU1	9326191033032	86	CLAFCL32WDL	9326191007866	445
CHAPEAU2	9326191033049	86	CLAFCL40WCW	9326191007880	445
CHAPEAU3	9326191033056	86	CLAFCL40WNW	9326191009310	445
CHAPEAU4	9326191033063	86	CLAFCL40WWW	9326191007873	445
CHESTER01	9326191029646	204	CLAHL150W	9326191006173	452
CHESTER02	9326191029653	204	CLAHL275W	9326191003950	452
CHEVEUX1	9326191018817	139	CLASSIC1A	9326191031854	159
CHEVEUX2	9326191018824	139	CLASSIC2A	9326191031861	159
CHEVEUX3	9326191018923	139	CLAT514WNW	9326191009280	444
CHEVEUX4	9326191018930	139	CLAT514WWW	9326191000751	444
CHUVA1	9326191025341	127	CLAW32	9326191014734	312
CHUVA2	9326191025358	127	CLEO1	9326191033353	83
CHUVA3	9326191025365	127	CLESSIDRA1	9326191038457	19
CIOTOLA1	9326191033155	72	CLESSIDRA1W	9326191038518	184
CIOTOLA2	9326191033162	72	CLESSIDRA1X3R	9326191038464	19
CIOTOLA3	9326191033179	72	CLESSIDRA2	9326191038471	20
CIOTOLA4	9326191033186	72	CLESSIDRA2W	9326191038525	184
CIOTOLA5	9326191033193	72	CLESSIDRA2X3R	9326191038488	20
CIOTOLA6	9326191033209	72	CLESSIDRA3	9326191038495	19
CKTRIO1	9326191031786	442	CLESSIDRA4	9326191038488	20
CKTRIO2	9326191031793	442	CLUSTER1	9326191031083	162
CKTRIO3	9326191031809	442	CLUSTER2	9326191031090	162
CLA111011	9326191011993	474	CLUSTER3	9326191031106	162
CLA1120011	9326191014147	474	CLUSTER4	9326191031113	162
CLA1615L	9326191014758	312	COMET01	9326191030147	346
CLA1615LBL	9326191029431	312	COMET02	9326191030154	346
CLA1615S	9326191014741	312	COMET03	9326191030161	346
CLA1615SBL	9326191029424	312	COMET04	9326191030178	346
CLA4736CB	9326191032950	266	COMET05	9326191035043	347
CLA4PB	9326191014017	471	COMET06	9326191035050	347
CLA6PB	9326191014024	471	COMET07	9326191036941	347
CLACFA25BC	9326191015731	448	COMET08	9326191036958	347
CLACFA25ES	9326191015748	448	CONN003	9326191026287	464
CLACFB25BC	9326191015830	448	CONN004	9326191026294	464
CLACFB25ES	9326191015847	448	CONN005	9326191037429	465
CLACFC25BC	9326191015755	449	CONN006	9326191037436	465
CLACFC25ES	9326191015762	449	CONN007	9326191037443	465
CLACFD25BC	9326191017148	449	CONTOUR1	9326191032981	87
CLACFD25ES	9326191017131	449	CONTOUR2	9326191032998	87
CLACFE25BC	9326191017162	450	CONTOUR3	9326191033001	87
CLACFE25ES	9326191017155	450	COOLIE01	9326191029257	323
CLACFF25BC	9326191017698	450	COOLIE02	9326191032332	323
CLACFF25ES	9326191017704	450	CORAZON1	9326191033308	77
CLADR12WFP	9326191012686	475	CORAZON2	9326191033315	77
CLAFCL22WNW	9326191009297	445	COSMOTRI03	9326191037252	348

Index by Part Number

PART NO.	BARCODE	PAGE	PART NO.	BARCODE	PAGE
COSMOTRI04	9326191037269	348	DIYBAT17	9326191031403	220
COSMOTRI05	9326191037276	348	DIYBAT18	9326191031410	220
COUP1	9326191035975	45	DIYBAT19	9326191031427	220
CRISTAL1	9326191038426	234	DIYBAT20	9326191031434	220
CRISTAL2	9326191038433	234	DIYBATC01	9326191031182	221
D			DIYBATC02	9326191031199	221
DAVOS	9326191025044	200	DIYBATC03	9326191031205	221
DECK01	9326191032059	329	DIYBATC04	9326191031212	221
DECK02	9326191032066	329	DIYBATC05	9326191031229	221
DECK03	9326191032073	329	DIYBATC06	9326191031236	221
DECK04	9326191032080	329	DIYPEN1	9326191037382	215
DEKSEL01	9326191029912	229	DIYPEN2	9326191037399	215
DEKSEL02	9326191029929	191	DOCCIA1	9326191011504	269
DEKSEL03	9326191029936	156	DOCCIA2	9326191011498	269
DEKSEL04	9326191032301	229	DRIV1	9326191016790	475
DEKSEL05	9326191032318	191	DU10WG24D1CW	9326191020285	445
DEKSEL06	9326191032325	157	DU13WG24D1WW	9327168003151	445
DELHI	9326191028557	200	DU18WG24D2WW	9326191017551	445
DHAKA	9326191038242	195	DUBAIG2	9326191027352	200
DIABLO1	9326191037009	29	DUE18WG24D2WW	9326191031540	446
DIABLO2	9326191037016	29	DUE26WWW4PIN	9326191018350	446
DIVO1	9326191016066	154	E		
DIVO10	9326191034015	154	ELLIP01	9326191010675	439
DIVO2	9326191016073	154	ELLIP02	9326191010668	439
DIVO3	9326191016080	154	ELLIP03	9326191010651	439
DIVO4	9326191016097	154	ELLIP04	9326191010248	439
DIVO5	9326191016103	154	ESCAMA1	9326191034985	82
DIVO6	9326191016110	154	ESCAMA2	9326191034992	82
DIVO7	9326191016127	154	ESPEJO1	9326191034572	68
DIVO8	9326191016134	154	ESPEJO1X3R	9326191034596	68
DIVO9	9326191016141	154	ESPEJO1X3S	9326191034589	68
DIYBAT01	9326191031243	216	ESPEJO2	9326191034602	68
DIYBAT02	9326191031250	216	ESPEJO2X3R	9326191034626	68
DIYBAT03	9326191031267	216	ESPEJO2X3S	9326191034619	68
DIYBAT04	9326191031274	216	ESPEJO3	9326191034633	70
DIYBAT05	9326191031281	217	ESPEJO3X3R	9326191034657	70
DIYBAT06	9326191031298	217	ESPEJO3X3S	9326191034640	70
DIYBAT07	9326191031304	217	ESPEJO4	9326191034664	70
DIYBAT08	9326191031311	217	ESPEJO4X3R	9326191034688	70
DIYBAT09	9326191031328	218	ESPEJO4X3S	9326191034671	70
DIYBAT10	9326191031335	218	ETH50.302VA	9327168095060	476
DIYBAT11	9326191031342	218	EX-108	9325574005604	494
DIYBAT12	9326191031359	218	EX-10812V	9326191031557	494
DIYBAT13	9326191031366	219	EX-288	9325574005574	493
DIYBAT14	9326191031373	219	EXEC9012	9323129092314	484
DIYBAT15	9326191031380	219	EXECH4	9323129092284	484
DIYBAT16	9326191031397	219	EXECH7	9323129092291	484

Index by Part Number

PART NO.	BARCODE	PAGE	PART NO.	BARCODE	PAGE
EXECHU1	9323129092307	484	G		
EXECHU2	9323129092512	484	G1251	9326191015618	427
EXELRIPPA	9323129057665	492	G12510	9326191036163	426
F			G12511	9326191036170	426
FARO1	9326191023187	110	G12512	9326191036187	426
FARO2	9326191023194	110	G1252	9326191015625	427
FINN1	9326191020179	118	G1253	9326191016028	427
FINN2	9326191020186	118	G1254	9326191016035	427
FINN3	9326191020193	118	G1257	9326191016707	427
FIREFLY01A	9326191036651	349	G1258	9326191016714	427
FLATMATE	9326191037917	172	G1259	9326191036156	426
FLOOD14	9326191023309	337	G401	9326191036293	436
FLOOD15	9326191027741	336	G403	9326191036880	436
FLOOD16	9326191027758	336	G90001	9326191023835	437
FLOOD22	9326191010958	337	G90002	9326191023842	437
FLUFFY	9323129057900	486	G9510	9326191036200	424
FOKUS01	9326191011818	180	G9511	9326191036217	424
FOKUS02	9326191011634	180	G9512	9326191036224	424
FOKUS03	9326191011610	180	G953	9326191016004	424
FOKUS04	9326191011603	180	G954	9326191016011	424
FOSSETTE1	9326191034428	74	G956	9326191016578	425
FOSSETTE2	9326191034435	74	G957	9326191016684	425
FOSSETTE3	9326191034442	74	G958	9326191016691	425
FOSSETTE4	9326191034459	74	G959	9326191036194	424
FP1.2M2W	9326191014031	469	GALTRIO1A	9326191036644	343
FP2M2W	9326191013614	469	GALTRIO2A	9326191036620	343
FP2M2WWH	9326191030697	469	GAMBA1	9326191023316	137
FP2M3W	9326191013621	469	GAMBA2	9326191023323	137
FP2M3WWH	9326191030703	469	GAMBA3	9326191024986	137
FP2WSB	9326191031472	469	GAMBA4	9326191024993	137
FP2WSW	9326191031489	469	GEB1	9326191027666	315
FP3M2WWH	9326191030710	469	GEB2	9326191027673	315
FP3M3WWH	9326191030727	469	GEB3	9326191027680	315
FR36	9326191015854	419	GIROTRI1	9326191037832	235
FR37	9326191014802	419	GIROTRI2	9326191038075	235
FR40	9326191014772	419	GLANSO1	9326191030925	246
FR41D	9326191035340	419	GLANSO2	9326191030932	246
FR42D	9326191035357	419	GLANSO3	9326191030949	246
FR43D	9326191035364	419	GLANSO4	9326191030956	246
FR44D	9326191035371	419	GLAZE1	9326191019593	124
FR45D	9326191035388	419	GLAZE10	9326191031014	125
FR46D	9326191035395	419	GLAZE11	9326191031021	125
FR47D	9326191035401	419	GLAZE2	9326191019609	124
FR48D	9326191035418	419	GLAZE3	9326191019616	124
FUMOSO1	9326191024023	131	GLAZE5	9326191026171	124
FUMOSO2	9326191024030	131	GLS10DB	9326191024689	417
FUMOSO3	9326191024047	131	GLS11DB	9326191029493	417

Index by Part Number

PART NO.	BARCODE	PAGE	PART NO.	BARCODE	PAGE
GLS12DB	9326191025723	417	HAK1	9326191038402	236
GLS13B	9326191023460	416	HAK2	9326191038419	236
GLS14B	9326191023477	416	HATHOR1	9326191029349	317
GLS15B	9326191023484	416	HATHOR2	9326191029325	317
GLS16B	9326191024702	416	HATHOR3	9326191029332	317
GLS21B	9326191027321	416	HEADLIGHTRESTKIT	9323129058020	487
GLS22B	9326191028106	416	HEKA1	9326191029288	250
GLS23B	9326191024719	416	HEKA2	9326191029295	250
GLS24B	9326191024597	416	HELSINKI	9326191038259	195
GLS25B	9326191027338	416	HEXA1	9326191030055	91
GLS26B	9326191028090	416	HEXA2	9326191030062	91
GLS27B	9326191028113	416	HEXADE1	9326191030079	90
GLS28B	9326191024603	416	HEXADE2	9326191030086	90
GLS29D	9326191025716	417	HIBTRI1	9326191037337	399
GLS30D	9326191025709	417	HINK1	9326191024924	230
GLS31	9326191027284	416	HINK2	9326191024931	230
GLS32	9326191027291	416	HOPI01	9326191029097	95
GLS33	9326191027307	416	HORTEN1	9326191023941	109
GLS34	9326191027314	416	HORTEN2	9326191023958	109
GLS36D	9326191036231	415	HORUS1	9326191024788	319
GLS37D	9326191036248	415	HORUS2	9326191024795	319
GLS38D	9326191036255	415	HORUS3	9326191024801	319
GLS39D	9326191036262	415	HORUS4	9326191024818	319
GLS9DB	9326191024726	417	I		
GLSTRIBC1	9326191036538	414	IDA1	9326191033322	78
GLSTRIES1	9326191036545	414	IDA2	9326191033339	78
GOLDA1	9326191033285	79	IGGLSQSS	9326191029974	330
GOLDA2	9326191033292	79	IGGLSS	9326191029967	330
GOLPE1	9326191035845	39	IGM1SS	9326191026492	332
GOLPE2	9326191035869	39	IGM2SS	9326191026508	332
GOLPE3	9326191035852	39	IGM3SS	9326191026515	332
GOLPE4	9326191035876	39	IGM4SS	9326191026522	332
GPO01	9326191025518	467	IGMEYEC	9326191026553	333
GPO02	9326191025495	467	IGMEYESS	9326191026546	333
GRABANDGO	9323129096435	489	IGMGRSS	9326191026539	333
GRABARAG	9326191010989	485	IGMLBR	9326191026607	331
GU1001A	9326191038389	409	IGMLC	9326191026621	331
GU1002	9326191027277	409	IGMLSQBR	9326191026614	331
GU1003D	9326191034268	410	IGMLSQC	9326191026638	331
GU1004D	9326191034275	410	IGMLSQSS	9326191026591	331
GU10B01A	9326191036606	410	IGMLSS	9326191026584	331
GU10G01A	9326191036590	410	IGMSMC	9326191026560	333
GU10R01A	9326191036583	410	IGMSMSS	9326191026577	333
GU10TRI1	9326191036514	409	J		
GX53001	9326191024467	435	JEREZ1	9326191034756	60
GX53002	9326191024474	435	JEREZ1X3R	9326191034770	60
H			JEREZ1X3S	9326191034763	60

Index by Part Number

PART NO.	BARCODE	PAGE	PART NO.	BARCODE	PAGE
JEREZ2	9326191034787	60	LEDW252	9323129058488	483
JEREZ2X3R	9326191034800	60	LEDW3157	9323129058617	484
JEREZ2X3S	9326191034794	60	LEDW920	9323129058556	483
JSSJL156	9325574006151	481	LEDW920A	9323129058563	484
K			LEDW921	9323129058549	484
KAM01	9326191030871	327	LEDW922	9323129058570	484
KHALEESI1	9326191020759	98	LEGNA1	9326191025402	119
KHALEESI2	9326191020766	98	LEGNA2	9326191025419	119
KHALEESI3	9326191020773	98	LEGNA3	9326191025426	119
KOLEC1	9326191036859	327	LEGNA4	9326191025433	119
KOPER1	9326191023200	121	LH0.4M	9326191604058	469
KOPER2	9326191023217	121	LH1.5M	9326191031496	469
KOPER3	9326191023224	121	LIGHTHOUSE	9323129086559	488
KUK1	9326191027642	251	LIGNA01	9326191029127	112
KUK2	9326191027659	251	LIGNA02	9326191029134	112
L			LIGNA03	9326191029141	112
LAMINA1	9326191024054	132	LIGNA04	9326191029158	112
LAMINA3	9326191024078	132	LIGNA05	9326191029165	112
LAMINA4	9326191036897	132	LIGNA06	9326191029172	112
LANTERNA1	9326191023163	111	LIGNA07	9326191029189	112
LANTERNA2	9326191023170	111	LIGNA08	9326191029196	112
LEADB001	9326191028434	470	LIGNA09	9326191029202	112
LEADB002	9326191028441	470	LIMA1	9326191038266	196
LEADB003	9326191028458	470	LIMA2	9326191038273	196
LEADB004	9326191028465	470	LINEAL1L	9326191037627	211
LEADB005	9326191028472	470	LINEAL1M	9326191037597	211
LEADB006	9326191028489	470	LINEAL1S	9326191037566	211
LEADB007	9326191028496	470	LINEAL2L	9326191037634	211
LEADB008	9326191028502	470	LINEAL2M	9326191037603	211
LEADB009	9326191028519	470	LINEAL2S	9326191037573	211
LEADW001	9326191028380	470	LINEAL3L	9326191037641	211
LEADW002	9326191028397	470	LINEAL3M	9326191037610	211
LEADW003	9326191028403	470	LINEAL3S	9326191037580	211
LEADW004	9326191028410	470	LINKTRIO1	9326191031991	396
LEADW005	9326191028427	470	LINKTRIO2	9326191032004	396
LED10COUGARTCH	9323129054398	489	LINKTRIO3	9326191032011	396
LED41WKL	9323129052974	493	LINKTRICN	9326191032042	396
LED65WKL	9323129052967	489	LINKTRIFP	9326191032035	396
LEDB242	9323129058495	482	LITTLEKRAKKA	9323129086665	492
LEDB264	9323129058587	482	LONDON	9326191013331	201
LEDB264FY	9323129058501	482	LOTUS1	9326191020940	175
LEDB265	9323129058594	482	LOTUS2	9326191020957	175
LEDB265D	9323129058600	482	LT4010	9326191024511	422
LEDF271	9323129058525	483	LT4011	9326191024504	422
LEDF272A	9323129058518	483	LT4012	9326191024344	422
LEDF274	9323129058532	483	LT4013	9326191024207	422
LEDRESIST	9323129058624	481	LT4014	9326191024191	422

Index by Part Number

PART NO.	BARCODE	PAGE	PART NO.	BARCODE	PAGE
LT4015	9326191024184	422	MASON4	9326191018619	128
LT4016	9326191024177	422	MASON5	9326191018626	128
LT4017	9326191024160	422	MASON6	9326191018633	128
LT40D01	9326191023576	423	MASON7	9326191018640	128
LT40D02	9326191023569	423	MASON8	9326191018657	128
LT40D03	9326191023552	423	MASON9	9326191018664	128
LT40D04	9326191023545	423	MATRIX-B	9326191020049	149
LT40D07	9326191023491	423	MATRIX-W	9326191020056	149
LT40D08	9326191023408	423	MAZZA	9326191025471	93
LYNX1	9326191038532	455	METI01	9326191029066	99
LYON	9326191026010	206	METI02	9326191029073	99
M			METI03W	9326191029080	192
MAGNUM1	9326191019722	231	MIKRO1	9326191037061	76
MAGNUM2	9326191019715	231	MIKRO2	9326191037078	76
MANGA1	9326191037849	23	MINIGRAB	9360447003462	485
MANGA2	9326191037856	23	MODELLO1	9326191024009	122
MANGA3	9326191037863	23	MODELLO2	9326191024016	122
MANGA4	9326191037870	23	MOTION1	9326191024399	351
MANGA5	9326191037887	23	MOTION2	9326191024405	351
MANU1	9326191036989	142	MOTION3	9326191024412	351
MANU2	9326191036996	142	MOTION4	9326191024429	351
MARACA1	9326191036453	30	MR1101	9326191034558	412
MARACA2	9326191036460	30	MR1102	9326191034565	412
MARACA3	9326191036477	30	MR1601A	9326191010699	411
MARACA4	9326191036484	30	MR1602A	9326191010682	411
MARACA5	9326191036491	30	MR16B01A	9326191036576	412
MARBRE1	9326191037023	38	MR16G01A	9326191036569	412
MARBRE2	9326191037030	38	MR16R01A	9326191036552	412
MARBRE3	9326191037047	38	MR16TRI1	9326191036521	411
MARINA1	9326191011481	249	N		
MARINA2	9326191011474	249	NAGOYA	9326191038204	197
MARRAKESH01	9326191032349	52	NARVIK1	9326191023910	153
MARRAKESH02	9326191032356	52	NARVIK2	9326191023927	153
MARRAKESH03A	9326191037283	52	NARVIK3	9326191023934	153
MARRAKESH04	9326191032370	52	NED01	9326191029219	257
MARRAKESH05	9326191032387	52	NED02	9326191029226	257
MARRAKESH06	9326191038600	54	NEW YORKG2	9326191032974	201
MARRAKESH07	9326191038617	54	NIGHT01	9326191014079	397
MARRAKESH08	9326191038624	54	NORDIC1	9326191017810	108
MARRAKESH09	9326191038631	54	NORDIC2	9326191017827	108
MARRAKESH10	9326191038648	54	NORDIC3	9326191017834	108
MARTE1	9326191034954	135	NORDIC4	9326191017841	108
MARTE2	9326191034961	135	NORDIC5	9326191017858	108
MARTE3	9326191034978	135	NORDIC6	9326191017865	108
MASON1	9326191018589	128	NOVADBLK01A	9326191037214	344
MASON2	9326191018596	128	NOVADBLK02	9326191033223	345
MASON3	9326191018602	128	NOVADBR01A	9326191037221	344

Index by Part Number

PART NO.	BARCODE	PAGE	PART NO.	BARCODE	PAGE
NOVADBR02	9326191033230	345	PASTEL07A	9326191036378	150
NOVADLUX01A	9326191037207	344	PASTEL08A	9326191036385	151
NOVADLUX02	9326191033216	345	PASTEL09A	9326191036392	151
NOVATRIS	9326191034503	350	PASTEL10A	9326191036408	151
O			PASTEL11A	9326191036415	151
OGATRI1	9326191037405	260	PASTEL12A	9326191036422	151
OGATRI2	9326191037412	260	PASTEL13A	9326191036439	151
OLA01	9326191032448	245	PASTEL14A	9326191036446	151
OLA02	9326191032622	245	PASTEL15TL	9326191027901	178
ORDITO1	9326191023354	126	PASTEL16TL	9326191027918	178
ORDITO2	9326191023361	126	PASTEL17TL	9326191027925	178
ORDITO3	9326191023378	126	PASTEL18TL	9326191027932	178
ORIGAMI1	9326191035289	49	PASTEL19TL	9326191027949	178
ORIGAMI2	9326191035296	49	PASTEL20TL	9326191027956	178
ORIGAMI3	9326191035302	49	PASTEL21TL	9326191027963	178
ORIGAMI4	9326191035319	49	PASTEL22FL	9326191027970	179
ORIGAMI5	9326191035326	49	PASTEL23FL	9326191027987	179
ORIGAMI6	9326191035333	49	PASTEL24FL	9326191027994	179
OTTER1	9326191016806	473	PASTEL25FL	9326191028007	179
OTTER2	9326191035982	473	PASTEL26FL	9326191028014	179
OTTER24V1	9326191022517	474	PASTEL27FL	9326191028021	179
OTTER24V2	9326191022487	474	PASTEL28FL	9326191028038	179
OTTER24V3	9326191022494	474	PASTILLE1	9326191033018	84
OTTER24V4	9326191022500	474	PASTILLE2	9326191033025	84
OTTER3	9326191035999	473	PATERA1	9326191035227	56
OTTER4	9326191036002	473	PATERA2	9326191035234	56
OTTER5	9326191036019	473	PATERA3	9326191035241	56
OTTER6	9326191036026	473	PDL1SQBL	9326191029271	278
OTTER7	9326191036637	473	PDL1SQBRZ	9326191028175	278
OTTER8	9326191037825	473	PDL1SQSS	9326191028199	278
OYSDIM001	9326191028328	267	PDLUDRECTBLK	9326191032660	279
OYSDIM002	9326191028335	267	PDLUDRECTBRZ	9326191028182	279
OYSDIM003	9326191010934	368	PDLUDRECTSS	9326191028205	279
OYSDIM004	9326191010927	368	PELOTA1	9326191037146	33
OYSDIM005	9326191010910	368	PELOTA2	9326191037153	33
P			PELOTA3	9326191037160	33
PAPILLON1	9326191033070	85	PELOTA4	9326191037177	33
PAPILLON2	9326191033087	85	PELOTA5	9326191037184	33
PAR3001	9326191030116	430	PELOTA6	9326191037191	33
PAR3802	9326191038150	429	PEN2	9326191016202	161
PARIS	9326191013355	202	PEN3	9326191016219	161
PASTEL01A	9326191036316	150	PENDOLO1	9326191029356	101
PASTEL02A	9326191036323	150	PENDOLO2	9326191029363	101
PASTEL03A	9326191036330	150	PENMATE	9326191037924	173
PASTEL04A	9326191036347	150	PENOLA	9326191018855	134
PASTEL05A	9326191036354	150	PESINI1	9326191035166	57
PASTEL06A	9326191036361	150	PESINI1W	9326191035104	186

Index by Part Number

PART NO.	BARCODE	PAGE	PART NO.	BARCODE	PAGE
PESINI2	9326191035173	57	PG3BARBL	9326191027000	293
PESINI2W	9326191035111	186	PG3BART	9326191026973	297
PESINI3	9326191035180	57	PG3BARWH	9326191029684	295
PESINI3W	9326191035128	186	PG4BARBL	9326191027017	293
PESINI4	9326191035197	57	PG4BART	9326191026980	297
PESINI4W	9326191035135	186	PG4BARWH	9326191029691	295
PESINI5	9326191035203	57	PG4SQBL	9326191029707	293
PESINI5W	9326191035142	186	PG4SQT	9326191029714	297
PESINI6	9326191035210	57	PG4SQWH	9326191029660	295
PESINI6W	9326191035159	186	PGUDBL	9326191026751	292
PG1ABL	9326191026874	292	PGUDBR	9326191030185	287
PG1ABR	9326191030246	287	PGUDBR1	9326191038341	288
PG1ABR1	9326191038358	288	PGUDBR2	9326191038563	289
PG1ABR2	9326191038570	289	PGUDC	9326191026720	284
PG1AC	9326191026843	284	PGUDCEC	9326191027123	285
PG1ACEC	9326191027086	285	PGUDCECA	9326191029875	286
PG1ACECA	9326191029837	286	PGUDSHSIL	9326191028137	291
PG1ASHSIL	9326191028151	291	PGUDSIL	9326191026775	298
PG1ASIL	9326191026898	298	PGUDSS	9326191026737	290
PG1ASS	9326191026850	290	PGUDT	9326191026744	296
PG1AT	9326191026867	296	PGUDWH	9326191026768	294
PG1AWH	9326191026881	294	PHARE01G	9326191029721	310
PG1FBL	9326191026812	292	PHARE01M	9326191029981	311
PG1FBR	9326191030222	287	PHARE02G	9326191029738	310
PG1FBR1	9326191038365	288	PHARE02M	9326191029998	311
PG1FBR2	9326191038587	289	PHARE03EXT	9326191032097	310
PG1FC	9326191026782	284	PHARE03G	9326191029752	310
PG1FCEC	9326191027109	285	PHARE03M	9326191029745	311
PG1FCECA	9326191029851	286	PHARE04EXT	9326191032103	310
PG1FSHSIL	9326191028144	291	PHARE04G	9326191029776	310
PG1FSIL	9326191026836	298	PHARE04M	9326191029769	311
PG1FSS	9326191026799	290	PHARE05G	9326191029790	310
PG1FT	9326191026805	296	PHARE05M	9326191029783	311
PG1FWH	9326191026829	294	PHARE06M	9326191030260	326
PG2ABL	9326191026935	292	PHARE07M	9326191030277	326
PG2ABR	9326191030208	287	PHOENIX	9326191015359	202
PG2AC	9326191026904	284	PIATTO1	9326191018831	160
PG2ACEC	9326191027147	285	PIATTO2	9326191018848	160
PG2ACECA	9326191029899	286	PILOT01	9326191034282	431
PG2ASHSIL	9326191028168	291	PLANA01	9326191032431	241
PG2ASIL	9326191026959	298	PLANA02	9326191032615	241
PG2ASS	9326191026911	290	PLC002	9326191031076	438
PG2AT	9326191026928	296	PLUG001	9326191026263	470
PG2AWH	9326191026942	294	PLUG002	9326191028373	470
PG2BARBL	9326191026997	293	PM1ABL	9326191020490	305
PG2BART	9326191026966	297	PM1ABR	9326191030253	301
PG2BARWH	9326191029677	295	PM1ACEC	9326191027079	299

Index by Part Number

PART NO.	BARCODE	PAGE	PART NO.	BARCODE	PAGE
PM1ACECA	9326191029844	300	R75	9326191037290	432
PM1ASHSIL	9326191019906	303	R76	9326191037306	432
PM1ASIL	9326191019913	307	R77	9326191037313	432
PM1ASS	9326191021329	302	R78	9326191037320	432
PM1AT	9326191021145	304	R80L1B	9326191025792	430
PM1AWH	9326191020261	306	R80L2B	9326191025808	430
PM1FBL	9326191022135	305	RAZORDM001A	9326191032196	372
PM1FBR	9326191030239	301	RAZORDM002A	9326191032202	372
PM1FCEC	9326191027093	299	RAZORDMW01	9326191032745	373
PM1FCECA	9326191029868	300	RAZORDMW02	9326191032752	373
PM1FSHSIL	9326191022104	303	REMO1	9326191028601	255
PM1FSIL	9326191022111	307	REMO2	9326191028618	255
PM1FSS	9326191017247	302	REPISATRI1	9326191038303	238
PM1FT	9326191022142	304	REPISATRI2	9326191038310	238
PM1FWH	9326191022128	306	RICTUS1	9326191027413	123
PM2ABL	9326191019555	305	RICTUS2	9326191027420	123
PM2ABR	9326191030215	301	RICTUS3	9326191027437	123
PM2ACEC	9326191027130	299	RICTUS4	9326191027444	123
PM2ACECA	9326191029905	300	RICTUS5	9326191027451	123
PM2ASHSIL	9326191019128	303	RICTUS6	9326191027468	123
PM2ASIL	9326191019135	307	RIOG2	9326191036613	202
PM2ASS	9326191019579	302	RIVERINA	9326191018886	134
PM2AT	9326191019562	304	ROCHE1	9326191035258	59
PM2AWH	9326191019371	306	ROCHE2	9326191035265	59
PMUDBL	9326191021480	305	ROCKY	9323129088461	491
PMUDBR	9326191030192	301	ROMEG2	9326191025440	203
PMUDCEC	9326191027116	299	ROTA1	9326191035968	46
PMUDCECA	9326191029882	300	RUBIK1	9326191024863	225
PMUDSHSIL	9326191018442	303	RUBIK2	9326191024870	225
PMUDSIL	9326191018480	307	S		
PMUDSS	9326191022081	302	SADDLE001	9326191026188	468
PMUDT	9326191021725	304	SADDLE002	9326191026195	468
PMUDWH	9326191018497	306	SADDLE003	9326191026201	468
PORTUS1FLC	9326191026416	313	SADDLE004	9326191026218	468
PORTUS1FLSS	9326191026423	313	SADDLE005	9326191026225	468
PORTUS1SPC	9326191026478	313	SADDLE006	9326191026232	468
PT818W5FT	9326191019548	441	SADDLE007	9326191026249	468
PT82FT4	9326191024351	441	SADDLE008	9326191026256	468
PT8TRI1	9326191037740	440	SANTIAGO	9326191038167	198
PT8TRI2	9326191037795	440	SARI1	9326191035951	42
R			SARI2	9326191036668	42
R63L1B	9326191033377	430	SEATTLE1	9326191013850	205
R63L2B	9326191027611	430	SEATTLE2	9326191013867	205
R71A	9326191023828	432	SEATTLE3	9326191013874	205
R72A	9326191023859	432	SEC01	9326191029615	401
R73A	9326191023866	432	SEC01S	9326191029592	401
R74A	9326191023873	432	SEC02	9326191029608	401

Index by Part Number

PART NO.	BARCODE	PAGE	PART NO.	BARCODE	PAGE
SEC02S	9326191029585	401	SHADE07	9326191031977	223
SEC03S	9326191032158	402	SHADE08	9326191031984	223
SEC04S	9326191032165	402	SHIELDTRI1	9326191034466	338
SEC05	9326191034299	280	SHIELDTRI2	9326191034473	338
SEC06	9326191034305	281	SHOPTRI	9326191031816	354
SEC07	9326191034312	282	SHOPTRI01	9326191032738	353
SEC08	9326191034329	280	SHU1	9326191011597	314
SEC08S	9326191034350	280	SHU2	9326191011580	314
SEC09	9326191034336	281	SHU3	9326191011573	314
SEC09S	9326191034367	281	SJS1200	9325574006298	478
SEC10	9326191034343	282	SJS1500	9325574006281	479
SEC10S	9326191034374	282	SJS1500TP	9325574006304	479
SEC11S	9326191038440	335	SJS3000	9326191029486	480
SEKER1	9326191011559	321	SKOPA1	9326191024900	228
SEKER2	9326191011542	321	SKOPA2	9326191024917	228
SEKER3	9326191011535	321	SLICKTRI1R	9326191032486	352
SENORITA1	9326191022227	100	SLICKTRI1S	9326191032516	352
SENORITA2	9326191022234	100	SLICKTRI2R	9326191032493	352
SENORITA3	9326191022241	100	SLICKTRI2S	9326191032523	352
SENORITA4	9326191024368	100	SLICKTRI3R	9326191032509	352
SENORITA5	9326191024375	100	SLICKTRI3S	9326191032530	352
SENORITA6	9326191024382	100	SLIM BENDY	9323129088454	491
SENS001	9326191025082	457	SM1ACEC	9326191027154	283
SENS002	9326191025099	457	SM1ACECA	9326191029820	283
SENS003	9326191025105	458	SMIP68ASS	9326191029264	328
SENS004	9326191025112	459	SMTFLOOD1	9326191036866	334
SENS005	9326191025129	460	SMTFLOOD2	9326191036873	334
SENS007	9326191027710	461	SMTGLS1	9326191032219	413
SENS008	9326191030673	461	SMTGLS2	9326191032226	413
SENS009	9326191032134	462	SMTGU101	9326191034381	408
SENS010	9326191032141	462	SMTNOVA1	9326191032233	342
SENS011	9326191034251	463	SMTOYS1	9326191032240	366
SENSORHEADLIGHT	9323129088447	488	SOCK2	9326191025136	466
SENTINEL1	9326191030031	144	SOCK3	9326191029417	466
SENTINEL2	9326191030048	144	SOMBRA01	9326191032462	242
SETH1	9326191024825	318	SOMBRA02	9326191032646	242
SETH2	9326191024832	318	SPECTRA01	9326191028762	433
SETH3	9326191024849	318	SPECTRA02	9326191028779	433
SETH4	9326191024856	318	SPECTRA03	9326191028786	433
SG1ACEC	9326191027161	283	SPECTRA04	9326191028793	433
SG1ACECA	9326191029813	283	SPIAGGIA1	9326191023255	141
SHADE01	9326191031915	222	SPIAGGIA2	9326191023262	141
SHADE02	9326191031922	222	SPIAGGIA3	9326191023279	141
SHADE03	9326191031939	222	SPIAGGIA4	9326191023286	141
SHADE04	9326191031946	222	SPM1ALBL	9326191030680	325
SHADE05	9326191031953	223	SPM1ALC	9326191026430	325
SHADE06	9326191031960	223	SPM1ALSS	9326191026447	325

Index by Part Number

PART NO.	BARCODE	PAGE	PART NO.	BARCODE	PAGE
SPM2ALBL	9326191029806	325	STE8	9326191025594	272
SPM2ALC	9326191026454	325	STE9	9326191026645	273
SPM2ALSS	9326191026461	325	STEAM2	9326191020827	189
SPMSBL	9326191027215	324	STEAM3	9326191020834	189
SPMSBL86	9326191027185	324	STRAND1	9326191023231	140
SPMSBR1	9326191038372	324	STRAND2	9326191023248	140
SPMSBR2	9326191038594	324	STRATO1	9326191029370	92
SPMSC	9326191027208	324	STRUNG1	9326191026102	187
SPMSSS	9326191027192	324	SUB3	9326191027390	429
SPMSSS86	9326191027178	324	SURAT	9326191038198	198
SPMST	9326191027222	324	SURFACE13	9326191025273	355
SPOT-BAR2B	9326191032813	164	SURFACE14	9326191025280	355
SPOT-BAR2W	9326191032806	165	SURFACE17A	9326191032882	356
SPOT-BAR3B	9326191032837	164	SURFACE18A	9326191032899	356
SPOT-BAR3W	9326191032820	165	SURFACE22	9326191032905	356
SPOT-BAR4B	9326191032851	164	SURFACE23	9326191032912	356
SPOT-BAR4W	9326191032844	165	SURFACE24	9326191032929	356
SPOT-R1B	9326191032776	164	SURFACE25	9326191032936	356
SPOT-R1W	9326191032769	165	SURFACETRI1R	9326191032547	369
SPOT-R3B	9326191032875	164	SURFACETRI1S	9326191032578	369
SPOT-R3W	9326191032868	165	SURFACETRI2R	9326191032554	369
SPOT-S1B	9326191032790	164	SURFACETRI3R	9326191032561	369
SPOT-S1W	9326191032783	165	SURFACETRI3S	9326191032592	369
SPUTNIK1	9326191023330	94	SWING1	9326191021916	107
SPUTNIK2	9326191023347	192	SWING2	9326191021923	107
SPY-C1	9326191019760	226	SWING3	9326191021930	107
SPY-C2	9326191019753	226	SWING4	9326191021947	107
SPY-W1	9326191019746	226	SWING5	9326191021954	107
SPY-W2	9326191019739	226	SWING6	9326191021961	107
STE10	9326191026652	273	SYDNEYG2	9326191029516	203
STE12	9326191026676	274	T		
STE13	9326191029233	275	TABLET2B	9326191014543	336
STE14	9326191029240	275	TACHE1	9326191037085	166
STE15	9326191030284	276	TACHE10	9326191037504	169
STE16	9326191030291	276	TACHE11	9326191037511	169
STE17	9326191030307	276	TACHE12	9326191037528	169
STE18	9326191030314	276	TACHE13	9326191037535	170
STE19	9326191030796	277	TACHE14	9326191037542	170
STE20	9326191030802	277	TACHE15	9326191037559	170
STE21	9326191030819	277	TACHE2	9326191037092	166
STE22	9326191030826	277	TACHE3	9326191037108	166
STE23	9326191036507	274	TACHE4	9326191037115	167
STE3	9326191015045	270	TACHE5	9326191037122	167
STE4	9326191015052	270	TACHE6	9326191037139	167
STE5	9326191025259	271	TACHE7	9326191037474	168
STE6	9326191025266	271	TACHE8	9326191037481	168
STE7	9326191025587	272	TACHE9	9326191037498	168

Index by Part Number

PART NO.	BARCODE	PAGE	PART NO.	BARCODE	PAGE
TAMA1	9326191028588	255	TRK1BL2M	9326191033391	387
TAMA2	9326191028595	255	TRK1BLADAP1	9326191035692	391
TAMBURA01	9326191028656	104	TRK1BLADAP2	9326191035715	391
TAMBURA02	9326191028649	104	TRK1BLCON1	9326191033421	387
TAMBURA03	9326191028670	104	TRK1BLCON2	9326191033438	387
TAMBURA04	9326191028663	104	TRK1BLCON3L	9326191033445	388
TAMBURA05	9326191028694	104	TRK1BLCON3R	9326191033452	388
TAMBURA06	9326191028687	104	TRK1BLCON4L1	9326191033469	388
TAMBURA07TL	9326191028717	176	TRK1BLCON4L2	9326191033476	388
TAMBURA08TL	9326191028700	176	TRK1BLCON4R1	9326191033483	388
TAMBURA09TL	9326191028724	176	TRK1BLCON4R2	9326191033490	388
TAMBURA10TL	9326191028731	176	TRK1BLCON5	9326191033506	389
TAMBURA11FL	9326191028748	177	TRK1BLCON6L	9326191033513	389
TAMBURA12FL	9326191028755	177	TRK1BLCON6R	9326191033995	389
TELE1	9326191037757	340	TRK1BLEND	9326191033520	389
TELEPLATE1	9326191037801	340	TRK1BLLEVEL	9326191033407	389
TIJUANA	9326191038181	198	TRK1BLLIVER	9326191033414	389
TOCA1	9326191028625	252	TRK1WH1M	9326191033537	387
TOCA2	9326191028632	252	TRK1WH2M	9326191033544	387
TOCA3	9326191033254	253	TRK1WHADAP1	9326191035685	391
TOCA4	9326191033261	253	TRK1WHADAP2	9326191035708	391
TOE2530PRO	9325574003419	493	TRK1WHCON1	9326191033575	387
TONO1	9326191024115	133	TRK1WHCON2	9326191033582	387
TONO2	9326191024122	133	TRK1WHCON3L	9326191033599	388
TONO3	9326191024139	133	TRK1WHCON3R	9326191033605	388
TOPATRI1	9326191038129	239	TRK1WHCON4L1	9326191033612	388
TOPATRI2	9326191038136	239	TRK1WHCON4L2	9326191033629	388
TOREN1	9326191038679	320	TRK1WHCON4R1	9326191033636	388
TORQUE1	9326191019708	232	TRK1WHCON4R2	9326191033643	388
TORQUE2	9326191019685	232	TRK1WHCON5	9326191033650	389
TORQUE3	9326191029943	233	TRK1WHCON6L	9326191033667	389
TORQUE4	9326191029950	233	TRK1WHCON6R	9326191034008	389
TORRE1	9326191036033	309	TRK1WHEND	9326191033674	389
TORRE2	9326191036040	309	TRK1WHLLEVEL	9326191033551	389
TORRE3	9326191036057	309	TRK1WHLLIVER	9326191033568	389
TORRE4	9326191036064	309	TRK3BL1M	9326191033681	379
TORRE5	9326191036071	309	TRK3BL2M	9326191033698	379
TORRE6	9326191036088	309	TRK3BLADAP3	9326191035739	384
TP001	9325574006076	478	TRK3BLADAP4	9326191035753	384
TRATTINO1	9326191034879	64	TRK3BLCEILKIT1	9326191035524	382
TRATTINO1X3R	9326191034893	64	TRK3BLCEILKIT2	9326191035548	382
TRATTINO1X3S	9326191034886	64	TRK3BLCON1	9326191033728	379
TRATTINO2	9326191034909	64	TRK3BLCON2	9326191033735	379
TRATTINO2X3R	9326191034923	64	TRK3BLCON3L	9326191033742	380
TRATTINO2X3S	9326191034916	64	TRK3BLCON3R	9326191033759	380
TREEC	9326191027062	227	TRK3BLCON4L1	9326191033766	380
TRK1BL1M	9326191033384	387	TRK3BLCON4L2	9326191033773	380

Index by Part Number

PART NO.	BARCODE	PAGE	PART NO.	BARCODE	PAGE
TRK3BLCON4R1	9326191033780	380	TRKTRI04	9326191037467	377
TRK3BLCON4R2	9326191033797	380	TRKW1G002	9326191034527	378
TRK3BLCON5	9326191033803	381	TRKW3G002	9326191034541	378
TRK3BLCON6	9326191033810	381	TUBO1	9326191037771	341
TRK3BLEND	9326191033827	382	TUBO2	9326191037788	341
TRK3BLFLEXCON	9326191035661	381	TUILE1	9326191033094	50
TRK3BLLIVEL	9326191033704	382	TUILE2	9326191033100	50
TRK3BLLIVER	9326191033711	382	TUILE3	9326191033117	50
TRK3BLNIPCON	9326191035777	384	TUILE4	9326191033124	50
TRK3BLSUSCLAMP	9326191035531	386	TUILE5	9326191033131	50
TRK3BLSUSKIT1	9326191035500	385	TUILE6	9326191033148	50
TRK3BLSUSKIT2	9326191035517	385	TULIP1	9326191034817	66
TRK3BLSUSKIT3	9326191035555	385	TULIP1X3R	9326191034831	66
TRK3BLSUSKIT4	9326191035562	385	TULIP1X3S	9326191034824	66
TRK3BLSUSKIT5	9326191035579	386	TULIP2	9326191034848	66
TRK3WH1M	9326191033834	379	TULIP2X3R	9326191034862	66
TRK3WH2M	9326191033841	379	TULIP2X3S	9326191034855	66
TRK3WHADAP3	9326191035722	384	U		
TRK3WHADAP4	9326191035746	384	ULAN1	9326191011528	268
TRK3WHCEILKIT1	9326191035609	382	ULAN2	9326191011511	268
TRK3WHCEILKIT2	9326191035623	382	V		
TRK3WHCON1	9326191033872	379	VAINA1	9326191035005	80
TRK3WHCON2	9326191033889	379	VAINA2	9326191035012	80
TRK3WHCON3L	9326191033896	380	VAINA3	9326191035029	80
TRK3WHCON3R	9326191033902	380	VAINA4	9326191035036	80
TRK3WHCON4L1	9326191033919	380	VANIDAD1L	9326191038549	212
TRK3WHCON4L2	9326191033926	380	VANIDAD2L	9326191038556	212
TRK3WHCON4R1	9326191033933	380	VANITAS1L	9326191037719	208
TRK3WHCON4R2	9326191033940	380	VANITAS1M	9326191037689	208
TRK3WHCON5	9326191033957	381	VANITAS1S	9326191037658	208
TRK3WHCON6	9326191033964	381	VANITAS2L	9326191037726	208
TRK3WHEND	9326191033971	382	VANITAS2M	9326191037696	208
TRK3WHFLEXCON	9326191035678	381	VANITAS2S	9326191037665	208
TRK3WHLIVEL	9326191033858	382	VANITAS3L	9326191037733	208
TRK3WHLIVER	9326191033865	382	VANITAS3M	9326191037702	208
TRK3WHNIPCON	9326191035760	384	VANITAS3S	9326191037672	208
TRK3WHSUSCLAMP	9326191035616	386	VANITY-1	9326191025013	213
TRK3WHSUSKIT1	9326191035586	385	VANITY-2	9326191025051	213
TRK3WHSUSKIT2	9326191035593	385	VELA	9326191025532	456
TRK3WHSUSKIT3	9326191035630	385	VENETO1BK	9326191021879	143
TRK3WHSUSKIT4	9326191035647	385	VENETO1X3BK	9326191021886	143
TRK3WHSUSKIT5	9326191035654	386	VENETO-T1	9326191021978	181
TRKB1G002	9326191034510	378	VENETO-T2	9326191021985	181
TRKB3G002	9326191034534	378	VENETO-W1	9326191022005	190
TRKTRI01	9326191036965	376	VENETO-W2	9326191021992	190
TRKTRI02	9326191036972	376	VENICEG2	9326191027369	203
TRKTRI03	9326191037450	377	VIENNA	9326191014468	204

Index by Part Number

PART NO.	BARCODE	PAGE	PART NO.	BARCODE	PAGE
VIGOL	9326191026119	206	ZARA5A	9326191031069	114
VIGOR	9326191026003	206	ZARA6A	9326191031830	115
VINTAJ1	9326191036675	35	ZARA7A	9326191031847	115
VINTAJ10	9326191036767	36	ZARA8A	9326191033360	115
VINTAJ11	9326191036774	36	ZARA9A	9326191033346	115
VINTAJ12	9326191036781	36			
VINTAJ13	9326191036798	37			
VINTAJ14	9326191036804	37			
VINTAJ15	9326191036811	37			
VINTAJ16	9326191036828	37			
VINTAJ17	9326191036835	37			
VINTAJ18	9326191036842	37			
VINTAJ2	9326191036682	35			
VINTAJ3	9326191036699	35			
VINTAJ4	9326191036705	35			
VINTAJ5	9326191036712	35			
VINTAJ6	9326191036729	35			
VINTAJ7	9326191036736	36			
VINTAJ8	9326191036743	36			
VINTAJ9	9326191036750	36			
VINUM1	9326191035081	58			
VINUM1W	9326191035067	185			
VINUM2	9326191035098	58			
VINUM2W	9326191035074	185			
VIRUN1	9326191037948	25			
VOTIF1	9326191036934	28			
VOX1	9326191028564	254			
VOX2	9326191028571	254			
VOX3	9326191010897	254			
W					
WEDGEGBL	9326191027048	256			
WEDGEGC	9326191027024	256			
WEDGEGSS	9326191027031	256			
WEDGEGWH	9326191027055	256			
WHITEBAND1X3	9326191020001	148			
WHITEBAND2X3	9326191020018	148			
WHITEBAND5	9326191020025	147			
WHITEBAND6	9326191020032	147			
WIG1	9326191010972	243			
WIG2	9326191010965	243			
WINDSCREENREPKIT	9323129058037	487			
Z					
ZARA10A	9326191031458	115			
ZARA1A	9326191031038	114			
ZARA2A	9326191031465	114			
ZARA3A	9326191031045	114			
ZARA4A	9326191031052	114			

General Contact & Accounts Enquiries

Sydney Head Office	Unit 2 16 Ada Brookvale NSW 2100 T: 02 9938 7100 F: 02 9938 7115 E: sales@clalighting.com.au	P.O. Box 7245 Warringah Mall NSW 2100
National Sales Manager	Annie Davis E: annie@clalighting.com.au	
Northern NSW	T: 02 9938 7100 (EST 8:00AM - 5:00PM) E: sales@clalighting.com.au	
Sydney / Southern NSW	Kathryn Rowan M: 0403 098 651 E: nsw2@clalighting.com.au	
QLD	Mary-Lou Morris M: 0418 113 180 E: qld1@clalighting.com.au	
VIC / TAS	Glen Symss M: 0421 826 859 E: vic2@clalighting.com.au	
WA	Chandraj Sinha M: 0413 586 447 E: wa1@clalighting.com.au	
SA/ NT	Chandraj Sinha M: 0413 586 447 E: wa1@clalighting.com.au	

New Zealand Head Office	20C Manga Road Silverdale Auckland 0932 T: 09 427 6133 E: sales@clalighting.co.nz	
North Island	MiChelle Castles M: 021 702 031 E: northisland@clalighting.co.nz	
South Island	T: 09 427 6133 E: sales@clalighting.co.nz	

Notes

**100% Australian
Owned Company
EST.1999**

Check CLA website to view our latest products

Australia: www.clalighting.com.au

New Zealand: www.clalighting.co.nz

Facebook: www.facebook.com/clalighting

Instagram: www.instagram.com/cla.lighting