

DOMUS[®]

Lighting 2024 - 2025





Our Showroom

domuslighting.com.au

We welcome you to visit our brand new stunning 1200m² wholesale showroom, by appointment. Be inspired with our constantly evolving and unique display of our range of residential interior lighting products, through to our range of innovative exterior LED Lighting products. Please contact your local Sales Representative or alternatively contact the Domus Lighting head office on (02) 9554 9600 for appointment booking.



Table of Contents

| Product | Page | Product | Page |
|---------------------------------|-------|------------------------|------|
| Interior | | Key MR11-3 | 68 |
| LED Downlights | | Key MR16 Glass | 69 |
| Tick-8 | 10 | Key GU10 Glass | 70 |
| Tack-8 | 11 | Key MR16 & GU10 TRIO | 71 |
| Boost-10 | 12 | Key T40 TRIO | 72 |
| Bliss-10 | 13 | Key-PAR Series | 73 |
| Swap Deep | 14 | LED Profiles | |
| Swap Sleek | 15 | Bloc 20 | 75 |
| Swap Step | 16 | Curve 20 | 76 |
| Surface Socket | 17 | Corner 16 RND | 77 |
| Deco Series | 18-22 | Micro SM | 78 |
| Tek Series | 23 | Micro REC | 79 |
| Aqua Series | 24-25 | Nova 17 SM | 80 |
| Cell Series | 26-30 | Nova 17 REC | 81 |
| Deep-9 | 32 | Nova 20 SM | 82 |
| Deep-10/12 | 34 | Nova 20 REC | 83 |
| Scoop Series | 35 | Nova 24 SM | 84 |
| Expo Series | 36-37 | Nova 24 REC | 85 |
| Neo Pro Recessed Series | 38-39 | Omega 17 SM | 86 |
| Moon Recessed Series | 40-41 | Bloc 42 | 87 |
| Ptco Series | 42-43 | Omega 35 SM | 88 |
| Astra Trio Series | 44 | Omega 35 REC | 89 |
| Moon Surface Mounted Series | 46-47 | LED Strip | |
| Neo Pro Surface Mounted Series | 48-49 | Plex COB 5 | 90 |
| Neo Surface Mounted Tilt Series | 50-51 | Plex COB 10 | 91 |
| Pistol Series | 52-53 | Plex COB 15 | 92 |
| LED Globes | | Plex COB 20 | 93 |
| LED Filament Series | 54-58 | Plex COB 5 IP67 | 94 |
| LED Retro Vintage Filament Lamp | 59-63 | Plex COB 10 IP67 | 95 |
| Key GLS 12V | 64 | Plex COB 15 IP67 | 96 |
| Key GLS TRIO | 65 | Plex COB 20 IP67 | 97 |
| Key G5.3 TRIO | 66 | Plex Vivid Series | 98 |
| Key G9 TRIO | 66 | Plex Vivid IP67 Series | 99 |
| Key G9 | 67 | Plex RGBTW Series | 100 |



Table of Contents

| Product | Page | Product | Page |
|-----------------------------------|------|---|---------|
| Plex RGBTW IP67 Series | 101 | Maxi-50 Down Wall Bracket Series | 138 |
| Plex RGB Series | 102 | Maxi-50 Up/Down Wall Bracket Series | 139 |
| Plex RGB IP67 Series | 103 | Maxi-Curve Surface Mount Series | 140 |
| Plex COB TW Series | 104 | Maxi-Curve Pendant Series | 141 |
| Plex COB TW IP67 Series | 105 | Maxi-75 Recessed Series | 142 |
| Plex COB Accessories | 106 | Maxi-75 Surface Mount Series | 143 |
| Plex MICRO Series | 107 | Maxi-75 Down Pendant Series | 144 |
| Plex ULTRA Series | 108 | Maxi-75 Up/Down Pendant Series | 145 |
| Plex ULTRA IP67 Series | 109 | Maxi-75 Down Wall Bracket Series | 146 |
| Plex SMD-5 IP66 Series | 110 | Maxi-75 Up/Down Wall Bracket Series | 147 |
| Plex SMD-9 Series | 112 | LED Ceiling Lights | |
| Plex SMD-9 IP67 Series | 113 | Mondo Round Series | 148 |
| Pleo 14.4 | 114 | Solar Round Series | 149 |
| Pleo 14.4S | 115 | Solar Square Series | 150 |
| LED Controllers | | Easy Series | 151 |
| CHAM-BT-RF-5C | 116 | Sunset Series | 152 |
| CHAM-REM-3C | 118 | Panel Backlit Series | 154 |
| CHAM-REM-1C | 119 | LED Panel Recessed Plaster Frames | 156 |
| CHAM-TOUCH-3C | 120 | LED Panel Surface Mount Frames | 156 |
| CHAM-TOUCH-1C | 121 | LED Panel Surface Mount Frames Installation Guide | 157 |
| CHAM-DR-4C | 122 | LED Panel Wire Suspension Kit | 157 |
| CHAM-DR-1C | 123 | LED Track Lights | |
| CHAM-DIM-DALI-4C | 124 | Moon Track Series | 160-161 |
| CHAM-DIM-DALI-1C | 125 | Moon Track Pendant Series | 162-163 |
| CHAM-DIM-DMX | 127 | Thor Series | 164-165 |
| LED Profile Systems | | Trak-3 Series | 168 |
| Maxi-40 Recessed Flat Series | 130 | Trak-3 Accessories | 169 |
| Maxi-40 Surface Mount Flat Series | 131 | Pendants | |
| Maxi-40 Pendant Flat Series | 132 | Allegra Series | 170 |
| Maxi-40 Down Wall Bracket Series | 133 | Forge Series | 171 |
| Maxi-50 Recessed Series | 134 | Strap Series | 171 |
| Maxi-50 Surface Mount Series | 135 | Carter Series | 172 |
| Maxi-50 Down Pendant Series | 136 | Spin | 174 |
| Maxi-50 Up/Down Pendant Series | 137 | Felix Series | 175 |



Table of Contents

| Product | Page | Product | Page |
|-------------------------------|---------|------------------------|---------|
| Hoist Series | 176 | Giana Series | 216 |
| Bubble Series | 177 | Sandra Series | 217 |
| Flaunt Series | 178 | Carter Series | 218 |
| Sands | 179 | Ashley | 219 |
| Sail Series | 180 | Leah Series | 220 |
| Eva Series | 181 | Marisol | 221 |
| Diana | 182 | Rustica | 222 |
| Ashley | 183 | Tinley Series | 223 |
| Evelyn Series | 184 | Carter Series | 224 |
| Moon Pendant Series | 186-187 | Floor Lamps | |
| Luna Series | 188 | Strap Series | 225 |
| Zoey Series | 190 | Allegra Series | 226 |
| Ruby Series | 191 | Forge | 227 |
| Jade-220 Series | 192 | Ashley | 228 |
| Jade-240 Series | 194 | Cyclops | 229 |
| Melody Series | 196 | Samson | 230 |
| Nova Series | 198 | Eden Series | 231 |
| LED Linear Pendants | | Elsa Series | 232 |
| Max-35 Series | 200 | Leah Series | 233 |
| Maxi-40 Flat Series | 202 | Marisol | 234 |
| Maxi-40 Low Series | 203 | Rustica | 235 |
| Maxi-40 High Series | 204 | Tinley Series | 236 |
| Maxi-50 1.2M Series | 205 | Carter Series | 237 |
| Maxi-50 1.7M Series | 206 | Bedside Light | |
| Maxi-50 2.4M Series | 207 | Charge-01 Series | 238 |
| Maxi-Curve 1.2M Series | 208 | Charge-02 Series | 239 |
| Maxi-Curve 1.7M Series | 209 | LED Wall Lights | |
| Maxi-Curve 2.4M Series | 210 | Lumaline-2 Series | 240 |
| Table & Desk Lamps | | Shadowline Series | 241 |
| Strap Series | 211 | Strap Series | 242 |
| Allegra Series | 212 | Glow 8 Series | 243 |
| Forge | 213 | Moon Wall Series | 244-245 |
| Sands | 214 | Sinta Series | 246 |
| Ashley Series | 215 | Deens 8 | 247 |



| Product | Page | Product | Page |
|-----------------------|---------|-------------------------------------|---------|
| Vanity Lights | | BF-8418 | 267 |
| Mirror Series | 248-249 | LED Step Lights | |
| Mirror Side Series | 250 | Camino Series | 268-269 |
| HL-804 Series | 251 | Ceiling Fans | |
| Ceramic Lights | | Strike 48 | 270 |
| BF-2012 | 252 | Strike Light Kit | 271 |
| BF-2013 | 252 | Strike 60 | 272 |
| BF-2014 | 253 | Strike Light Kit | 273 |
| BF-2018 | 253 | Blast 48 | 274 |
| BF-2019 | 254 | Blast Light Kit | 275 |
| BF-2020 | 254 | Blast 52 | 276 |
| BF-2185 | 255 | Blast Light Kit | 277 |
| BF-2350 | 255 | Glide 80 | 278 |
| BF-2440 | 256 | Glide Light Kit | 279 |
| BF-2601A | 256 | Axis 48 | 280 |
| BF-2601B | 257 | Axis 48 Light | 281 |
| BF-2607A | 257 | Motion 52 | 282 |
| BF-2607B | 258 | Motion 52 Light | 283 |
| BF-2608A | 258 | Hover 56 | 284 |
| BF-7577 | 259 | Hover 56 Light | 285 |
| BF-7578 | 259 | Fresco 52 | 286 |
| BF-2608B | 260 | Fresco 52 Light | 287 |
| BF-7310 | 260 | Ceiling Fan Accessories | 288-289 |
| BF-7603 | 262 | LED Battens | |
| BF-7908 | 262 | Bolt Series | 290 |
| BF-7949 | 263 | Bolt Emergency Series | 291 |
| BF-8042 | 263 | Hydro Weatherproof Series | 292-293 |
| BF-8235 | 264 | Hydro Emergency Weatherproof Series | 292-293 |
| BF-8258 | 264 | Park Series | 294-295 |
| BF-8284 | 265 | Park Emergency Series | 294-295 |
| BF-8286 | 265 | Impact Series | 296 |
| BF-8259 | 266 | | |
| BF-8276 | 266 | | |
| BF-8411 | 267 | | |



| Product | Page | Product | Page |
|------------------------|---------|-------------------------------------|---------|
| Exterior | | LED Spot Lights | |
| LED Wall Lights | | Elite Adjustable | 349 |
| Shadow Series | 298-304 | LED Security Lights | |
| Finn-8 Series | 306 | Muro-Eco Series | 350 |
| Zelda-18 Series | 307 | Muro-Max Series | 351 |
| Halo Series | 308 | Muro-Pro Series | 352-353 |
| Livi Series | 309 | LED Garden Lights | |
| Miley 10 Series | 310 | Elite Spike | 354 |
| Alpha Series | 311 | Kira Spike | 355 |
| Ptper 1 Series | 312-313 | Zoom Pro Series | 356 |
| Piper 2 Series | 314-315 | Shadow Spike Series | 358 |
| Whisper Series | 316 | Shadow Path Series | 359 |
| Dash Series | 318 | Dusk Path Series | 360 |
| Sierra Series | 320 | Dusk Stick Series | 361 |
| Bell Series | 322 | Dusk Spike MR11 | 362 |
| Block Series | 324 | Dusk Spike MR16 | 363 |
| Edge Series | 325 | LED Deck Lights | |
| Dent Series | 326 | Vivid Series | 364-365 |
| Kira Series | 328 | Deka Series | 366 |
| Casa Series | 329 | Magneto Series | 369-371 |
| Claro Series | 330 | Modula Series | 372 |
| Como Series | 331 | LED Bunker Lights | |
| York Series | 333 | Versa Series | 373 |
| LED Step Lights | | Polysphere & Accessories | |
| Zone Series | 334 | Polysphere Series | 374 |
| Zac Series | 336-338 | 60mm Aluminium Post Series | 376 |
| Zeke-9 Series | 340 | 76mm Aluminium Post Series | 377 |
| Zeke-4 Series | 341 | Bollard Lights | |
| Zeke-8 Series | 342 | BL-100 | 378 |
| You Series | 343 | BL-100-1M-KIT | 379 |
| LED Floodlights | | BL-200 | 380 |
| Blaze-Pro Series | 344 | BL-200-1M-KIT | 381 |
| Blaze-Pro Accessories | 346-347 | | |
| Flash-20 Series | 348 | | |



| Product | Page | Product | Page |
|------------------------------|---------|----------------------------|---------|
| BL-300 | 382 | Emergency Lights | |
| BL-300-1M-KIT | 383 | Evac D63 Surface Mounted | 462 |
| BL-400 | 384 | Evac D63 Recessed | 462 |
| BL-400-1M-KIT | 385 | Exit Surface Mount Series | 464-465 |
| LED Solar Lights | | Exit Recessed Mount Series | 466-467 |
| Sunsolar-1 | 386 | Evac D40 Mini | 468 |
| Sunsolar-1-Kit | 387 | Trak 3 EM D40 | 469 |
| Traditional Exteriors | | Sunset Series | 472-473 |
| Monaco Series | 388-393 | Park-DIFF | 474/476 |
| Lisbon Series | 394-400 | Park-WG | 475/477 |
| Siena Series | 401-406 | Hydro Series | 478-479 |
| Vienna | 407-414 | Bolt Series | 480-481 |
| Vienna Large Series | 415-418 | SENSOR Surface Mounted | 482 |
| Chester Series | 419-426 | SENSOR Recessed Mounted | 483 |
| Chester Large Series | 427-430 | | |
| Paris Series | 431-436 | | |
| Avignon Series | 437-442 | | |
| Turin Series | 443-448 | | |
| Turin Large Series | 449-452 | | |
| Accessories | 453-455 | | |
| LED Drivers | | | |
| WP-12V Series | 456 | | |
| WP-24V Series | 458 | | |
| WP-350mA Series | 460 | | |
| WP-700mA Series | 461 | | |

IP Rating Chart

The Ingress Protection Rating consists of the letters IP followed by two digits. The first digit refers to the protection against the ingress of solids particles and the second digit to the protection against the ingress of liquids.



| IP | Effective Against | Description |
|----|-------------------|--|
| 0 | - | No protection against contact and ingress of objects |
| 1 | ≥50mm | Any large surface of the body, such as the back of a hand, but no protection against deliberate contact with a body part. |
| 2 | >12.5mm | Fingers or similar objects |
| 3 | >2.5mm | Tools, thick wires, etc. |
| 4 | >1mm | Most wires, slender screws, large ants etc. |
| 5 | Dust Protected | Ingress of dust is not entirely prevented, but it must not enter in sufficient quantity to interfere with the safe operation of the equipment. |
| 6 | Dust-Tight | No ingress of dust; complete protection against contact (dust-tight). A vacuum must be applied. Test duration of up to 8 hours based on airflow. |

| IP | Effective Against | Description |
|----|--|--|
| 0 | None | ---- |
| 1 | Dripping Water | Dripping water (vertically falling drops) shall have no unsafe effect on the specimen when mounted in an upright position onto a turntable and rotated at 1 RPM. |
| 2 | Dripping water when tilted at 15° | Vertically dripping water shall have no harmful effect when the enclosure is tilted at an angle of 15° from its normal position. A total of four positions are tested within two axes. |
| 3 | Spraying water | Water falling as a spray at any angle up to 60° from the vertical shall have no harmful effect, utilizing either: a) an oscillating fixture, or b) A spray nozzle with a counterbalanced shield. |
| 4 | Splashing of water | Water splashing against the enclosure from any direction shall have no harmful effect, utilizing either: a) an oscillating fixture, or b) A spray nozzle with no shield. |
| 5 | Water jets | Water projected by a nozzle (6.3 mm) against enclosure from any direction shall have no harmful effects. |
| 6 | Powerful water jets | Water projected in powerful jets (12.5 mm) against the enclosure from any direction shall have no harmful effects. |
| 6K | Powerful water jets with increased pressure | Water projected in powerful jets (6.3 mm nozzle) against the enclosure from any direction, under elevated pressure, shall have no harmful effects. |
| 7 | Immersion, up to 1 meter (3 ft 3 in) depth | Ingress of water in harmful quantity shall not be possible when the enclosure is immersed in water under defined conditions of pressure and time (up to 1 meter of submersion). |
| 8 | Immersion, 1 meter (3 ft 3 in) or more depth | The equipment is suitable for continuous immersion in water under conditions which shall be specified by the manufacturer. However, with certain types of equipment, it can mean that water can enter but only in such a manner that it produces no harmful effects. The test depth and duration is expected to be greater than the requirements for IPx7, and other environmental effects may be added, such as temperature cycling before immersion. |
| 9K | Powerful high-temperature water jets | Protected against close-range high pressure, high-temperature spray downs. Smaller specimens rotate slowly on a turntable, from 4 specific angles. Larger specimens are mounted in the intended position when being used, no turntable required, and are tested freehand for at least 3 minutes at a distance of 0.15–0.2 meters. |



Multi CCT LED's

Technology

Multi-CCT LED's are products that can produce up to 5 different colour temperatures, throughout the Domus catalogue you'll find products that have this function.

This is the breakdown of the available options:

With over 60 years heritage of manufacturing and distribution of lighting products for the Australasian market, Domus Lighting has developed a highly regarded reputation for innovation, quality and reliability. We are focused on continuing that reputation by investing in energy efficient lighting products, using the latest lighting technologies. Domus, was formed in 1961 in response to a growing need for quality lighting products. Now, Domus Lighting has expanded to become one of Australia's leading distributors of LED lighting to the Electrical Wholesale and Lighting Retail distribution channels.

Proudly 100% Australian owned, the company operates from a modern 13,000m² distribution facility and head office. Domus Lighting also offers a custom made lighting service to help provide a solution to those exciting and challenging designs. Our team are committed to applying their unrivalled LED experience and lighting expertise to enhance any of your energy saving lighting requirements. Combining that capability with the strength of our sales force, you can count on us to support you for all your lighting needs.

XWW= 2700K | WW= 3000K | NW= 4000K
W= 5000K | XW= 5700K





LED Downlights



Tick-8

- Flat-face frame.
- Polyamide frame and heat sink.
- Fully dimmable with suitable dimmers.
- Double Insulated
- Class II (No Earth Required)
- Optional Black and Satin Chrome Fascia covers available

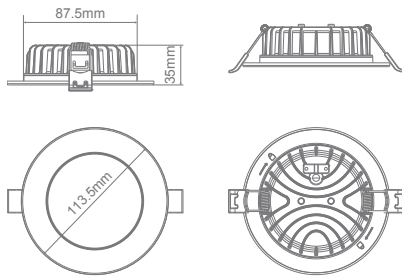

Cutout: 90mm

| Item No. | Variant | | |
|------------|---------|-------|-------|
| | Wht | Blk | Snck |
| TICK-COVER | N/A | 20829 | 20830 |

| Item No. | Variant | CCT | Wattage | IP Rating | Lumen Output | | |
|------------|---------|------|---------|-----------|------------------|---------------------|-------------|
| | | | | | Warm White 3000K | Neutral White 4000K | White 5700K |
| TICK-8-WHT | 20828 | TRIO | 8W | 44 | 750lm | 800lm | 780lm |



LED Downlights



Tack-8

- Anti-glare frame.
- Polyamide frame and heat sink.
- Fully dimmable with suitable dimmers.
- Double Insulated
- Class II (No Earth Required)
- Optional Black and Satin Chrome Fascia covers available

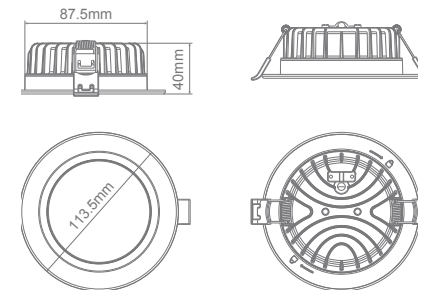

Cutout: 90mm

| Item No. | Variant | | |
|------------|---------|-------|-------|
| | Wht | Blk | Snck |
| TACK-COVER | N/A | 20833 | 20834 |

| Item No. | Variant | CCT | Wattage | IP Rating | Lumen Output | | |
|------------|---------|------|---------|-----------|------------------|---------------------|-------------|
| | | | | | Warm White 3000K | Neutral White 4000K | White 5700K |
| TACK-8-WHT | 20832 | TRIO | 8W | 44 | 750lm | 800lm | 780lm |



Boost-10

- Anti-glare frame.
- Polyamide frame and heat sink.
- Fully dimmable with suitable dimmers.
- Double Insulated
- Class II (No Earth Required)

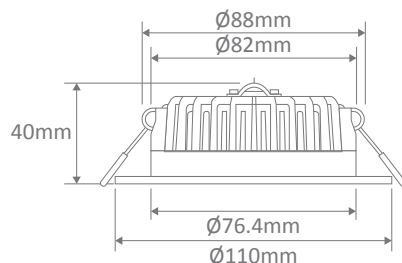

Cutout: Ø90mm

| Item No. | Variants | | CCT | Wattage | IP Rating | Lumen Output | | |
|-----------------|--------------|--------------|------|---------|-----------|------------------|---------------------|-------------|
| | Blk | Wht | | | | Warm White 3000K | Neutral White 4000K | White 5700K |
| BOOST-10 | 20727 | 20726 | TRIO | 10W | 54 | 750lm | 780lm | 800lm |



Bliss-10

- Flat face frame.
- Polyamide frame and heat sink.
- Fully dimmable with suitable dimmers.
- Double Insulated
- Class II (no Earth Required)

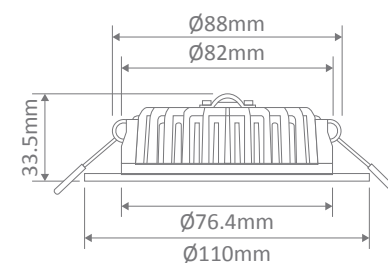

Cutout: Ø90mm

| Item No. | Variants | | CCT | Wattage | IP Rating | Lumen Output | | |
|-----------------|--------------|--------------|------|---------|-----------|------------------|---------------------|-------------|
| | Blk | Wht | | | | Warm White 3000K | Neutral White 4000K | White 5700K |
| BLISS-10 | 20707 | 20706 | TRIO | 10W | 54 | 750lm | 780lm | 800lm |



LED Downlights



Swap Deep

- Deep-face frame.
- Polyamide frame and heat sink.
- Fully dimmable with suitable dimmers.
- Double Insulated.
- Class II (No earth required).

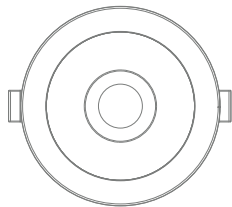
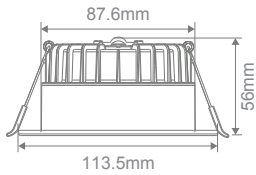

Cutout: Ø90mm - 100mm



LED Downlights



Swap Sleek

- Flat-face frame.
- Polyamide frame and heat sink.
- Fully dimmable with suitable dimmers.
- Double Insulated.
- Class II (No earth required).

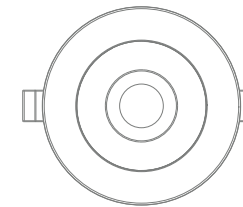
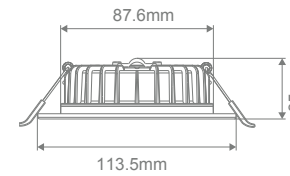

Cutout: Ø90mm - 100mm

| Item No. | Variants | Colour | CCT | Wattage | IP Rating | Lumen Output | | |
|-------------|----------|--------------|------|---------|-----------|------------------|---------------------|-------------|
| | | | | | | Warm White 3000K | Neutral White 4000K | White 5700K |
| SWAP-8-DEEP | 21445 | Wht/Wht | TRIO | 8W | IP44 | 800lm | 900lm | 850lm |
| | 21446 | Blk/Blk | | | | | | |
| | 21447 | Wht/Gunmetal | | | | | | |
| | 21448 | Wht/Gold | | | | | | |
| | 21449 | Wht/Chrome | | | | | | |

| Item No. | Variants | Colour | CCT | Wattage | IP Rating | Lumen Output | | |
|--------------|----------|--------------|------|---------|-----------|------------------|---------------------|-------------|
| | | | | | | Warm White 3000K | Neutral White 4000K | White 5700K |
| SWAP-8-SLEEK | 21455 | White | TRIO | 8W | IP44 | 800lm | 900lm | 850lm |
| | 21456 | Black | | | | | | |
| | 21457 | Satin Chrome | | | | | | |



Swap Step

- Step-face frame.
- Polyamide frame and heat sink.
- Fully dimmable with suitable dimmers.
- Double Insulated.
- Class II (No earth required).

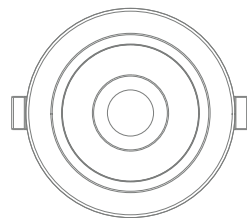
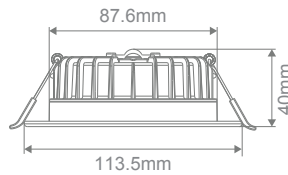

Cutout: Ø90mm - 100mm

| Item No. | Variants | Colour | CCT | Wattage | IP Rating | Lumen Output | | |
|-------------|----------|--------------|------|---------|-----------|------------------|---------------------|-------------|
| | | | | | | Warm White 3000K | Neutral White 4000K | White 5700K |
| SWAP-8-STEP | 21451 | White | TRIO | 8W | IP44 | 800lm | 900lm | 850lm |
| | 21452 | Black | | | | | | |
| | 21453 | Satin Chrome | | | | | | |



Surface Socket

- 10A Surface Mount plug
- Designed for easy installation
- Snap-On Plate for fast and efficient mounting
- Highly durable

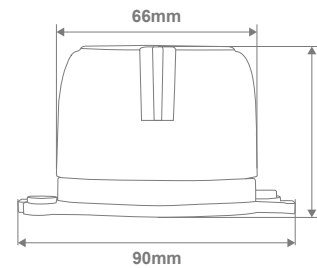

| Item No. | Variants |
|-----------------------|--------------|
| SURFACE-SOCKET | 20949 |



Deco Series

- Anti-glare frame.
- Cast Aluminium frame and heat sink.
- Fully dimmable with suitable dimmers.
- DALI option now available, production lead times apply.



DECO-8-RND



DECO-13-RND

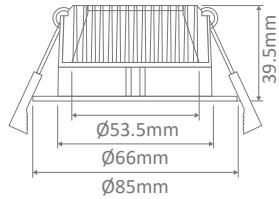

Cutout: Ø70-75mm

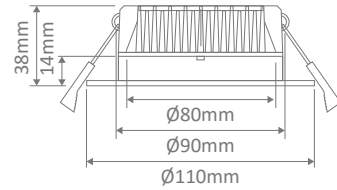

Cutout: Ø90mm

| Item No. | Variants | | | Wattage | IP Rating | CCT | Lumen Output | | |
|-------------|----------|-------|-------|---------|-----------|------|------------------|---------------------|-------------|
| | Blk | Alu | Wht | | | | Warm White 3000K | Neutral White 4000K | White 5700K |
| DECO-8 | 20411 | 20412 | 20410 | 8W | 44 | TRIO | 700lm | 750lm | 800lm |
| | DALI | | | | | | | | |
| | 21586 | 21587 | 21585 | | | | | | |
| DECO-13-RND | 20421 | 20422 | 20420 | 13W | 44 | TRIO | 1186lm | 1306lm | 1237lm |
| | DALI | | | | | | | | |
| | 21589 | 21590 | 21588 | | | | | | |



DECO-13-RND-WHT



LED Downlights



Deco Series

- Anti-glare frame.
- Cast Aluminium frame and heat sink.
- Fully dimmable with suitable dimmers.
- DALI option now available, production lead times apply.



DECO-13-SQR



DECO-13T

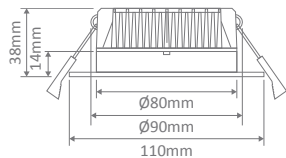

Cutout: Ø90mm

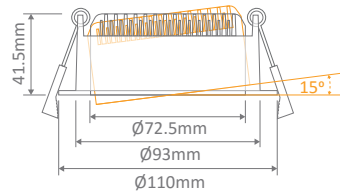

Cutout: Ø95mm

| Item No. | Variants | | | Wattage | IP Rating | CCT | Lumen Output | | |
|--------------|----------|-------|-------|---------|-----------|------|------------------|---------------------|-------------|
| | Blk | Alu | Wht | | | | Warm White 3000K | Neutral White 4000K | White 5700K |
| DECO-13-SQR | 20528 | 20427 | 20425 | 13W | 44 | TRIO | 1186lm | 1306lm | 1237lm |
| | DALI | | | | | | | | |
| | 21592 | 21593 | 21591 | | | | | | |
| DECO-13-TILT | 21045 | N/A | 20430 | 13W | 44 | TRIO | 1186lm | 1306lm | 1237lm |
| | DALI | | | | | | | | |
| | 21668 | N/A | 21667 | | | | | | |



LED Downlights



Deco Series

- Anti-glare frame.
- Cast Aluminium frame and heat sink.
- Fully dimmable with suitable dimmers.
- DALI option now available, production lead times apply.



DECO-20

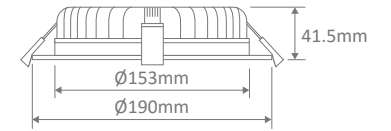

Cutout: Ø160 - Ø170mm



DECO-28

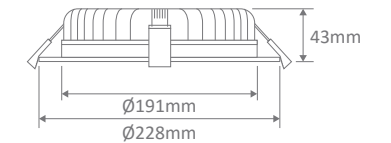

Cutout: Ø200 - Ø210mm

| Item No. | Variants | | Wattage | IP Rating | CCT | Lumen Output | | |
|----------|----------|-------|---------|-----------|------|------------------|---------------------|-------------|
| | Blk | Wht | | | | Warm White 3000K | Neutral White 4000K | White 5700K |
| DECO-20 | 20433 | 20432 | 20W | 44 | TRIO | 1700lm | 1750lm | 1800lm |
| | DALI | | | | | | | |
| | 21595 | 21594 | | | | | | |
| DECO-28 | 20435 | 20434 | 28W | 44 | TRIO | 2300lm | 2350lm | 2400lm |
| | DALI | | | | | | | |
| | 21597 | 21596 | | | | | | |



Deco Series



- 140mm Adaptor plate to suit Deco-13 (Fixed version only).
- Cast Aluminium, powder coated.
- Ideal for covering larger holes from Ø100-130mm.



DECO-13-ADAP

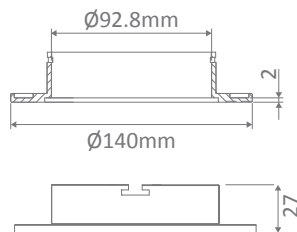

| Item No. | Variants | |
|-----------|----------|-------|
| | Blk | Wht |
| DECO-ADAP | 20507 | 20504 |



Tek Series



- Flat face frame.
- Cast Aluminium frame and heat sink.
- Fully dimmable with suitable dimmers.
- DALI option now available, production lead times apply.



TEK-13

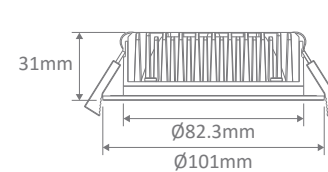

Ø90mm Cutout



| Item No. | Variants | | | Wattage | IP Rating | CCT | Lumen Output | | |
|----------|----------|-------|-------|---------|-----------|------|------------------|---------------------|-------------|
| | Blk | Schr | Wht | | | | Warm White 3000K | Neutral White 4000K | White 5700K |
| TEK-13 | 20621 | 20445 | 20443 | 13W | 44 | TRIO | 800lm | 850lm | 900lm |
| | DALI | | | | | | | | |
| | 21599 | 21600 | 21598 | | | | | | |



LED Downlights



Aqua Series

- COB LED Chip.
- Cast Aluminium frame and heat sink.
- Fully dimmable with suitable dimmers.
- Suitable for wet areas, IP65*.
- DALI option now available, production lead times apply.



AQUA-10-WHT



AQUA-13-BLK

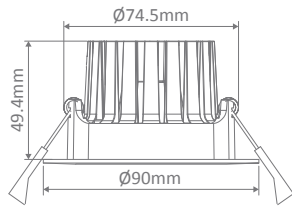

Cutout: Ø75-80mm

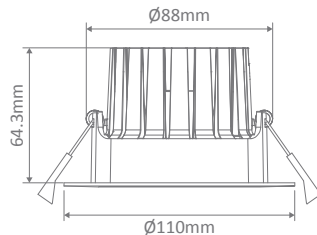

Cutout: Ø90-95mm

| Item No. | Variants | | | | Wattage | IP Rating | CCT | Lumen Output | | |
|----------|----------|-------|-------|-------|---------|-----------|------|---------------------|------------------------|----------------|
| | Standard | | DALI | | | | | Warm White 3000K | Neutral White 4000K | White 5000K |
| | Blk | Wht | Blk | Wht | | | | | | |
| AQUA-10 | 21270 | 21271 | 21287 | 21288 | 10W | 65* | TRIO | 870lm | 980lm | 930lm |
| AQUA-13 | 21272 | 21273 | 21289 | 21290 | 13W | 65* | TRIO | 1130lm | 1300lm | 1220lm |

*Downlight housing has been tested and is rated at IP65. Test conducted in an installed application from the underside of the downlight.



LED Downlights



Aqua Series

- COB LED Chip.
- Cast Aluminium frame and heat sink.
- Fully dimmable with suitable dimmers.
- Suitable for wet areas, IP65*.
- DALI option now available, production lead times apply.



AQUA-13-TILT

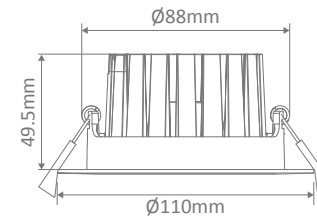

Tilt: 30°
Cutout: Ø90-95mm

| Item No. | Variants | | | | Wattage | IP Rating | CCT | Lumen Output | | |
|--------------|----------|-------|-------|-------|---------|-----------|------|---------------------|------------------------|----------------|
| | Standard | | DALI | | | | | Warm White 3000K | Neutral White 4000K | White 5000K |
| | Blk | Wht | Blk | Wht | | | | | | |
| AQUA-13-TILT | 21274 | 21278 | 21291 | 21292 | 13W | 65* | TRIO | 1130lm | 1300lm | 1220lm |

*Downlight housing has been tested and is rated at IP65. Test conducted in an installed application from the underside of the downlight.



Cell 9

- COB LED Chip.
- Interchangeable lens.
- Cast Aluminium frame and heat sink.
- Fully dimmable with suitable dimmers.
- DALI option now available, production lead times apply.
- A replaceable solution to re-lamp when used with compatible frames.
- CRI 90



| Item No. | Variants | | IP Rating | CCT - Lumen Output | | | | |
|-------------|----------|-------|-----------|--------------------|-------|-------|-------|-------|
| | Standard | DALI | | 2700K | 3000K | 4000K | 5000K | 5700K |
| CELL-9-5CCT | 26980 | 21637 | 44 | 60° | | | | |
| | | | | 649lm | 660lm | 717lm | 755lm | 772lm |
| | 26981 | 21638 | 44 | 36° | | | | |
| | | | | 640lm | 651lm | 738lm | 749lm | 766lm |
| | 26982 | 21639 | 44 | 24° | | | | |
| 681lm | | | | 688lm | 748lm | 788lm | 807lm | |
| 26983 | 21640 | 44 | 15° | | | | | |
| | | | 656lm | 662lm | 717lm | 757lm | 772lm | |



Cell 13

- COB LED Chip.
- Interchangeable lens.
- Cast Aluminium frame and heat sink.
- Fully dimmable with suitable dimmers.
- DALI option now available, production lead times apply.
- A replaceable solution to re-lamp when used with compatible frames.
- CRI 90

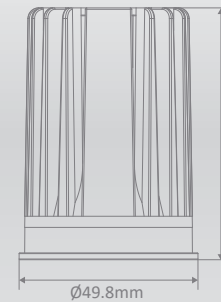

| Item No. | Variants | | IP Rating | CCT - Lumen Output | | | | |
|--------------|----------|-------|-----------|--------------------|--------|--------|--------|--------|
| | Standard | DALI | | 2700K | 3000K | 4000K | 5000K | 5700K |
| CELL-13-5CCT | 26984 | 21641 | 44 | 60° | | | | |
| | | | | 1002lm | 995lm | 1098lm | 1163lm | 1145lm |
| | 26985 | 21642 | 44 | 36° | | | | |
| | | | | 990lm | 1000lm | 1077lm | 1120lm | 1137lm |
| | 26986 | 21643 | 44 | 24° | | | | |
| 1037lm | | | | 1030lm | 1108lm | 1154lm | 1175lm | |
| 26987 | 21644 | 44 | 15° | | | | | |
| | | | 965lm | 975lm | 1050lm | 1092lm | 1160lm | |



Choose a module



9W-13W

Choose a frame

P75 - K75



D75

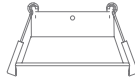

T75

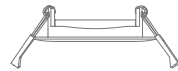

T90



D90

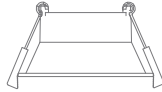

DT90

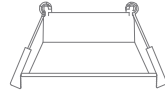

W90

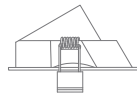

S1

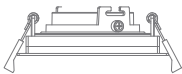

S2

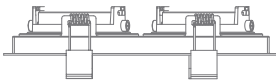

S3

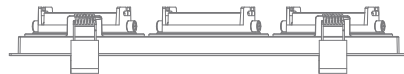

Press down firmly until module clicks into frame.

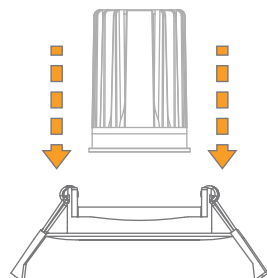

Multiple Combinations

CELL-K75 & P75

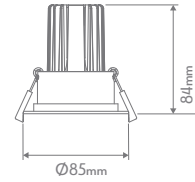

Cutout: $\varnothing 70-75\text{mm}$

CELL-D75

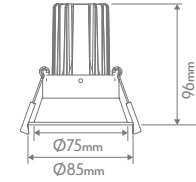

Cutout: $\varnothing 75-77\text{mm}$

CELL-T75

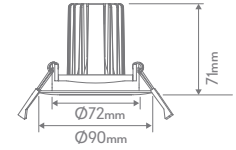

Cutout: $\varnothing 72-75\text{mm}$
Tiltable to 15°

CELL-D90 & DT90

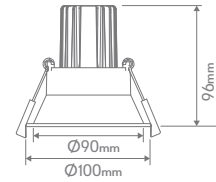

Cutout: $\varnothing 90-92\text{mm}$
DT90 Tiltable to 15°

CELL-T90

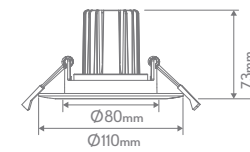

Cutout: $\varnothing 85-90\text{mm}$
Tiltable to 15°

CELL-W90

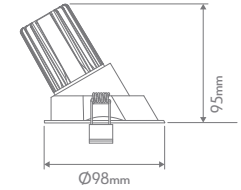

Cutout: $\varnothing 88-90\text{mm}$
W90 wall washer frame is set at a 45° angle.

CELL-S1

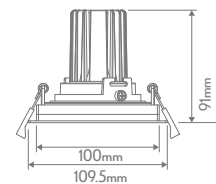

Cutout: L100mm x W100mm

CELL-S2

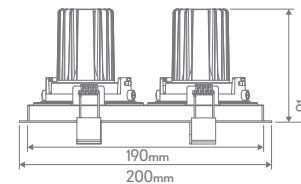

Cutout: L190mm x W100mm

CELL-S3

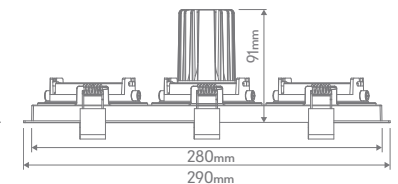

Cutout: L280mm x W100mm



LED Module Downlights

Interior



CELL-P75



CELL-K75



CELL-T75



CELL-D75



CELL-W90



CELL-T90



CELL-DT90



CELL-D90



CELL-S1



CELL-S2



CELL-S3

| Item No. | Variants | Frame Colour |
|-----------|----------|--------------|
| CELL-D75 | 27048 | White |
| | 27049 | Black |
| CELL-D90 | 27050 | White |
| | 27051 | Black |
| CELL-DT90 | 27078 | White |
| | 27079 | Black |
| CELL-T75 | 27052 | White |
| | 27053 | Black |
| CELL-T90 | 27054 | White |
| | 27055 | Black |
| CELL-K75 | 27064 | White |
| | 27065 | Black |
| CELL-P75 | 27062 | White |
| | 27063 | Black |
| CELL-W90 | 27056 | White |
| | 27057 | Black |
| CELL-S1 | 27058 | White |
| | 27059 | Black |
| CELL-S2 | 27060 | White |
| | 27061 | Black |
| CELL-S3 | 27070 | White |
| | 27071 | Black |

Please note the codes above are for frames only.

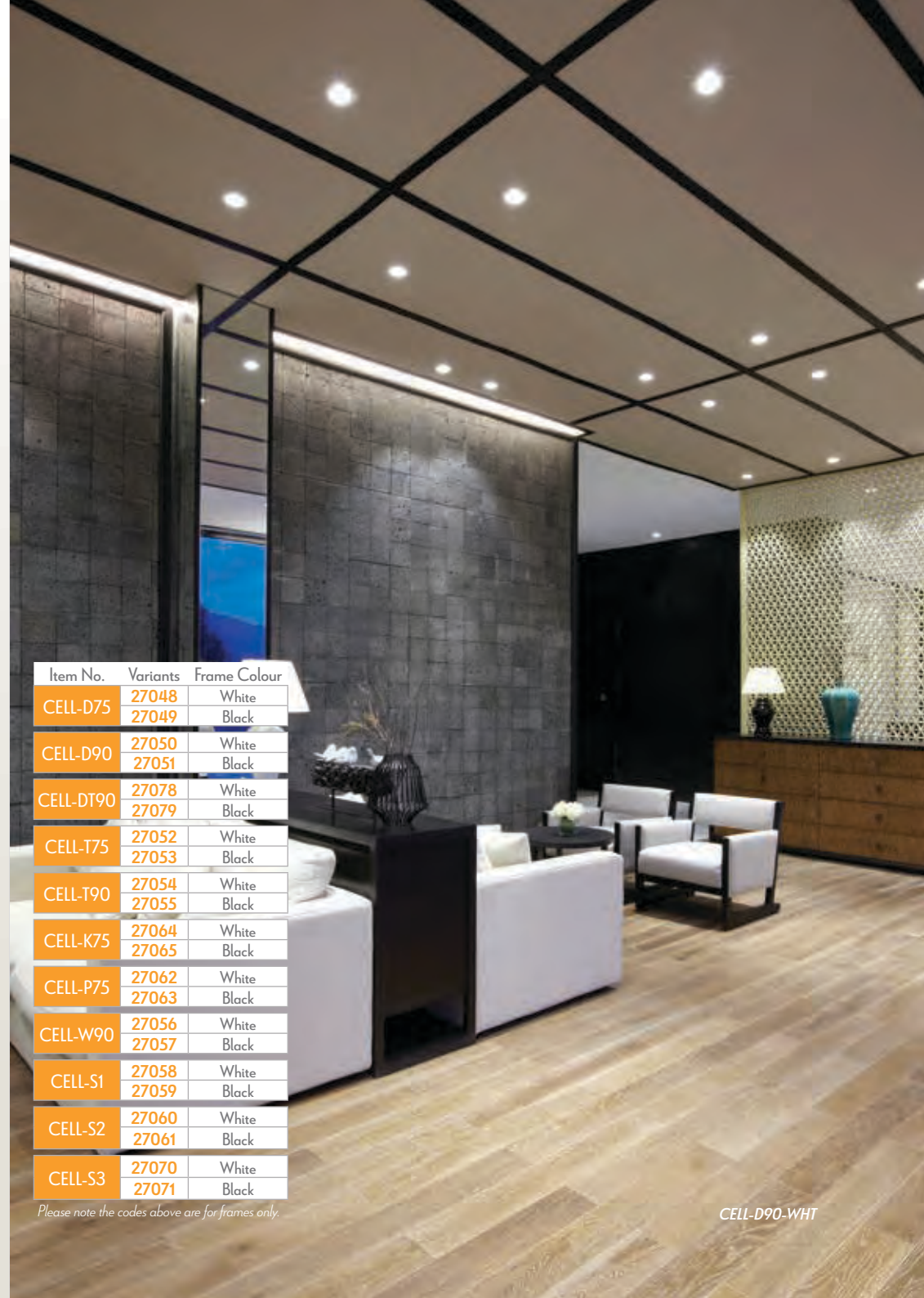

CELL-D90-WHT



Deep Series

- SMD LED Chip.
- Anti-glare deep-set frame.
- Polyamide frame, Cast Aluminium heat sink.
- Fully dimmable with suitable dimmers.
- DALI option now available, production lead times apply.



DEEP-9-WHT

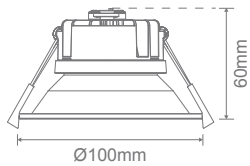

Cutout: Ø88-Ø90mm



DEEP-13-WHT

| Item No. | Variants | | CCT | Wattage | IP Rating | Lumen Output | | |
|---------------|--------------|--------------|------|---------|-----------|---------------------|------------------------|----------------|
| | Standard | DALI | | | | Warm White 3000K | Neutral White 4000K | White 5000K |
| DEEP-9 | 20815 | 20816 | TRIO | 9W | 54 | 840lm | 964lm | 920lm |



LED Downlights



Deep Series

- COB LED Chip.
- Anti-glare deep-set frame.
- Tiltable.
- Cast Aluminium frame and heat sink.
- Fully dimmable with suitable dimmers.
- DALI option now available, production lead times apply.



DEEP-10-WHT



DEEP-12-BLK

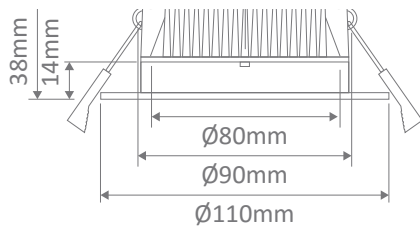

Cutout: Ø90mm

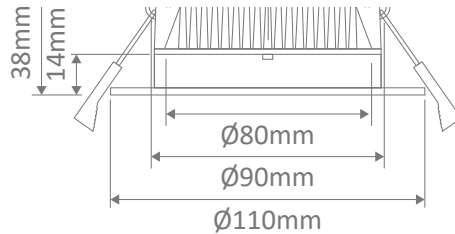

Cutout: Ø90mm

| Item No. | Variants | | | | Wattage | IP Rating | CCT | Lumen Output | | |
|----------|----------|-------|-------|-------|---------|-----------|------|---------------------|------------------------|----------------|
| | Standard | | DALI | | | | | Warm White 3000K | Neutral White 4000K | White 5000K |
| | Blk | Wht | Blk | Wht | | | | | | |
| DEEP-10 | 21729 | 21730 | 21733 | 21734 | 10W | 40 | TRIO | 993lm | 1053lm | 1017lm |
| DEEP-12 | 21731 | 21732 | 21738 | 21736 | 12W | 40 | TRIO | 1174lm | 1289lm | 1202lm |



LED Downlights



Scoop Series

- COB LED Chip.
- Adjustable and Directional.
- Cast Aluminium frame and heat sink.
- Fully dimmable with suitable dimmers.
- DALI option now available, production lead times apply.



SCOOP-13-BLK



SCOOP-25-WHT

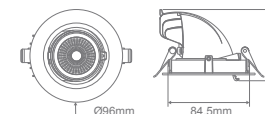

Cutout: Ø85mm

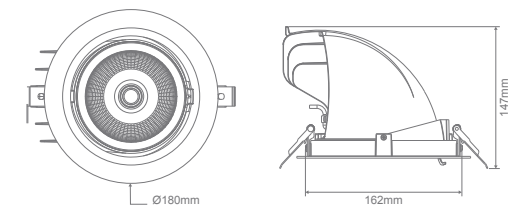

Cutout: Ø160mm - Ø170mm

| Item No. | Variants | | | | Wattage | IP Rating | CCT | Lumen Output | | |
|----------|----------|-------|-------|-------|---------|-----------|------|---------------------|------------------------|----------------|
| | Standard | | DALI | | | | | Warm White 3000K | Neutral White 4000K | White 5000K |
| | Blk | Wht | Blk | Wht | | | | | | |
| SCOOP-13 | 20466 | 20468 | 20467 | 20469 | 13W | 20 | TRIO | 780lm | 880lm | 870lm |
| SCOOP-25 | 20470 | 20472 | 20471 | 20473 | 25W | 20 | TRIO | 2010lm | 2231lm | 2230lm |



Expo Series

- Anti-glare deep-set frame.
- Low UGR ≤ 19.
- Cast Aluminium frame and heat sink.
- Fully dimmable with suitable dimmers.
- DALI option now available, production lead times apply
- CRI 90



EXPO-10

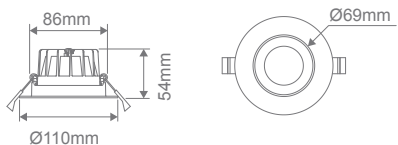

Cutout: Ø90-95mm



EXPO-25

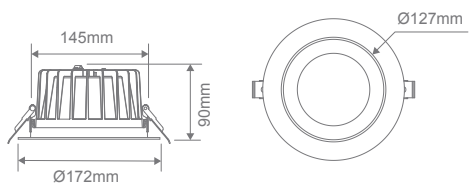

Cutout: Ø150-165mm

| Item No. | Variants | | | | Wattage | IP Rating | CCT | Lumen Output | | |
|----------|----------|-------|-------|-------|---------|-----------|------|---------------------|------------------------|----------------|
| | Standard | | DALI | | | | | Warm White 3000K | Neutral White 4000K | White 5700K |
| | Blk | Wht | Blk | Wht | | | | | | |
| EXPO-10 | 20710 | 20711 | 21602 | 21601 | 10W | 44 | TRIO | 710lm | 780lm | 850lm |
| EXPO-25 | 20712 | 20713 | 21604 | 21603 | 25W | 44 | TRIO | 2200lm | 2400lm | 2600lm |



Expo Series

- Anti-glare deep-set frame.
- Low UGR ≤ 19.
- Cast Aluminium frame and heat sink.
- Fully dimmable with suitable dimmers.
- DALI option now available, production lead times apply.
- CRI 90



EXPO-35

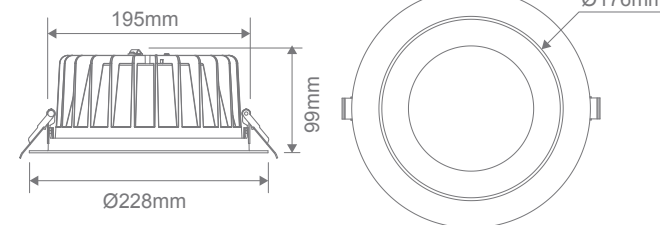

Cutout: Ø200-210mm

| Item No. | Variants | | | | Wattage | IP Rating | CCT | Lumen Output | | |
|----------|----------|-------|-------|-------|---------|-----------|------|---------------------|------------------------|----------------|
| | Standard | | DALI | | | | | Warm White 3000K | Neutral White 4000K | White 5700K |
| | Blk | Wht | Blk | Wht | | | | | | |
| EXPO-35 | 20714 | 20715 | 21606 | 21605 | 35W | 44 | TRIO | 3650lm | 3750lm | 3850lm |



Neo Pro Recessed Series

- SMD LED Chip.
- Cast Aluminium frame and heat sink.
- Fully dimmable with suitable dimmers.
- Anti-glare deep set frame, frosted diffuser
- DALI option now available, production lead times apply.



| Item No. | Variants | | | | Wattage | IP Rating | CCT | Lumen Output | | |
|----------------|----------|-------|-------|-------|---------|-----------|------|--------------|--------|--------|
| | Standard | | DALI | | | | | 3000K | 4000K | 5700K |
| | Blk | Wht | Blk | Wht | | | | | | |
| NEO-PRO-13-REC | 20915 | 20916 | 21608 | 21607 | 13W | 65 | TRIO | 850lm | 1000lm | 900lm |
| NEO-PRO-25-REC | 20917 | 20918 | 21610 | 21609 | 25W | 65 | TRIO | 2250lm | 2400lm | 2300lm |
| NEO-PRO-35-REC | 20919 | 20920 | 21612 | 21611 | 35W | 65 | TRIO | 3200lm | 3400lm | 3300lm |



Neo Pro Recessed Series

- SMD LED Chip.
- Cast Aluminium frame and heat sink.
- Fully dimmable with suitable dimmers.
- DALI option now available, production lead times apply.

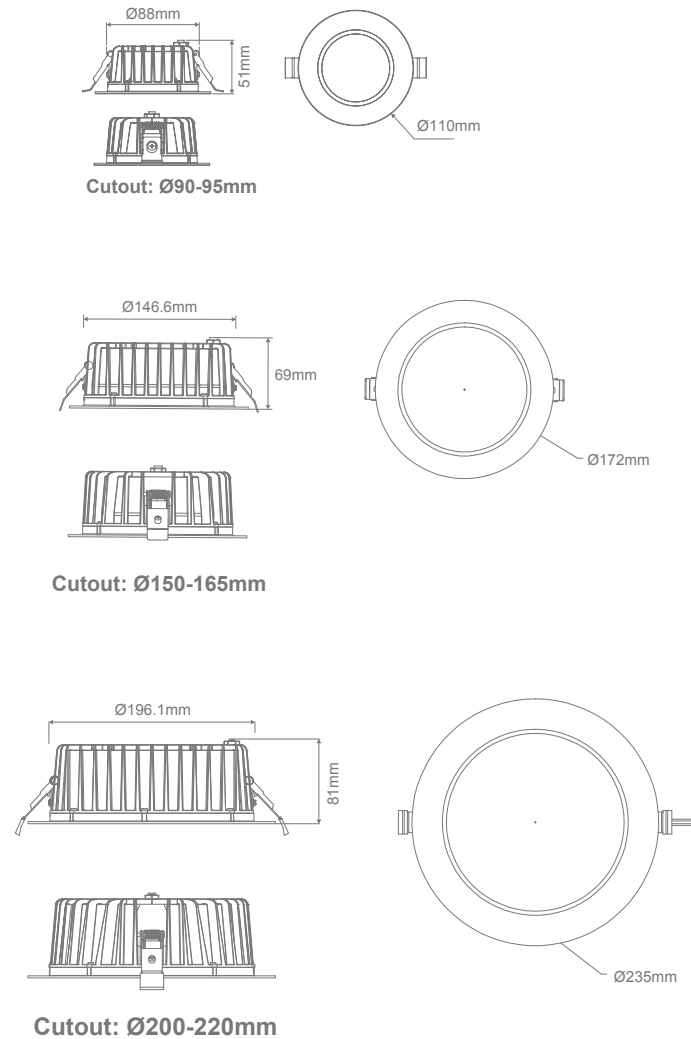



LED Downlights



Moon Recessed Series

- SMD LED Chip.
- 6W/9W Power Switchable.
- 45° Tiltable, 355° Rotatable.
- Fully dimmable with suitable dimmers.
- Optional coloured baffles available for Tube or Spot Reflectors.
- CRI 90



LED Downlights



Interior

Interior



MOON-REC-SPOT



MOON-REC-TUBE



MOON-REC-OPAL



MOON-REC-FLD

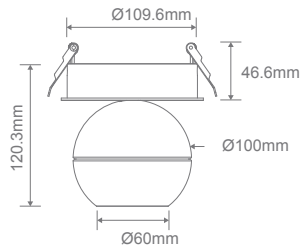

Cutout: Ø110mm

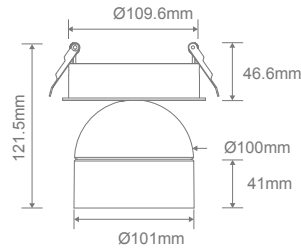

Cutout: Ø110mm

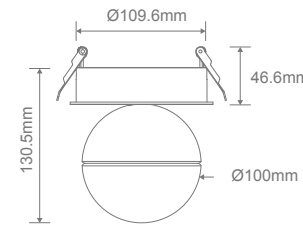

Cutout: Ø110mm

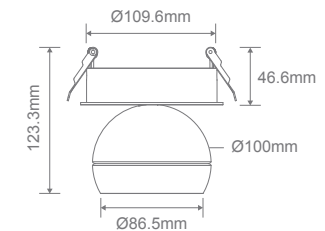

Cutout: Ø110mm

| Item No. | Variants | | Wattage | IP | CCT |
|----------|----------|-------------|---------|----|------|
| | Blk | Wht | | | |
| MOON-REC | FLD | 22804 22805 | 6/9W | 20 | TRIO |
| | OPAL | 22806 22807 | | | |
| | SPOT | 22808 22809 | | | |
| | TUBE | 22810 22811 | | | |

6W - Lumen Output

| Warm White 3000K | | | | Neutral White 4000K | | | | White 5700K | | | |
|------------------|-----------|----------|----------|---------------------|-----------|----------|----------|-------------|-----------|----------|----------|
| Flt-60° | Opal-130° | Spot-30° | Tube-60° | Flt-60° | Opal-130° | Spot-30° | Tube-60° | Flt-60° | Opal-130° | Spot-30° | Tube-60° |
| 477lm | 433lm | 498lm | 430lm | 556lm | 504lm | 534lm | 504lm | 561lm | 513lm | 536lm | 515lm |

9W - Lumen Output

| Warm White 3000K | | | | Neutral White 4000K | | | | White 5700K | | | |
|------------------|-----------|----------|----------|---------------------|-----------|----------|----------|-------------|-----------|----------|----------|
| Flt-60° | Opal-130° | Spot-30° | Tube-60° | Flt-60° | Opal-130° | Spot-30° | Tube-60° | Flt-60° | Opal-130° | Spot-30° | Tube-60° |
| 651lm | 600lm | 661lm | 593lm | 780lm | 719lm | 756lm | 716lm | 775lm | 729lm | 751lm | 708lm |



LED Cabinet Lights



Pico Series

- Complete with driver.
- Cast Aluminium frame and heat sink.
- DALI option now available, production lead times apply.



PICO-3-WHT

PICO-3-TILT-WHT

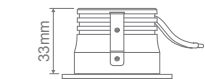
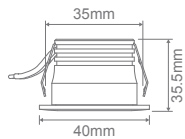

Cutout: Ø35mm
Driver fits through cutout hole

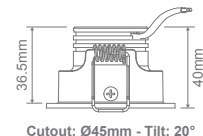
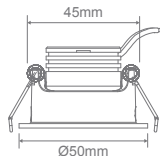

Cutout: Ø45mm - Tilt: 20°
Driver fits through cutout hole

| Item No. | Variants | | | | Wattage | IP Rating | CCT | Lumen Output | | |
|-------------|----------|-------|-------|-------|---------|-----------|------|---------------------|------------------------|----------------|
| | Standard | | DALI | | | | | Warm White 3000K | Neutral White 4000K | White 5700K |
| | Blk | Wht | Blk | Wht | | | | | | |
| PICO-3 | 21575 | 21576 | 21662 | 21661 | 3W | 40 | TRIO | 180lm | 210lm | 210lm |
| PICO-3-TILT | 21577 | 21578 | 21664 | 21663 | 3W | 40 | TRIO | 180lm | 210lm | 210lm |



LED Cabinet Lights



Pico Series

- Complete with driver.
- Cast Aluminium frame and heat sink.
- DALI option now available, production lead times apply.

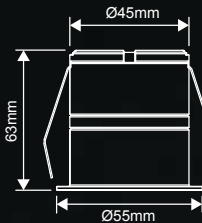

Cutout: Ø50mm
Driver fits through cutout hole

PICO-7



| Item No. | Variants | | | | Wattage | IP Rating | CCT | Lumen Output | | |
|----------|----------|-------|-------|-------|---------|-----------|------|---------------------|------------------------|----------------|
| | Standard | | DALI | | | | | Warm White 3000K | Neutral White 4000K | White 5700K |
| | Blk | Wht | Blk | Wht | | | | | | |
| PICO-7 | 21581 | 21582 | 21666 | 21665 | 7W | 40 | TRIO | 390lm | 470lm | 460lm |



Astra Trio Series

- Recessed / Surface Mounted Installation options in one fitting.
- 12V DC Constant Voltage LED Driver required.



Recessed Application

Surface Mounted Application

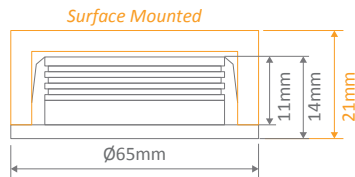

Recessed Cutout: Ø57mm

| Item No. | Variants | | | | | Wattage | IP Rating | CCT | Lumen Output | | |
|------------|----------|-------|-------|-------|-------|---------|-----------|------|--------------|-------|-------|
| | Blk | Slr | Wht | Sbrs | Chr | | | | 3000K | 4000K | 5000K |
| ASTRA-TRIO | 21517 | 21518 | 21516 | 21519 | 21520 | 3.6W | 20 | TRIO | 200lm | 230lm | 205lm |

Requires 12V DC Constant Voltage LED Driver - Wire in Parallel



ASTRA-TRIO



Moon Surface Mounted Series

- SMD LED Chip.
- 6W/9W Power Switchable.
- 45° Tiltable, 355° Rotatable.
- Fully dimmable with suitable dimmers.
- Optional coloured baffles available for Tube or Spot Reflectors.
- CRI 90



MOON-SM-SPOT

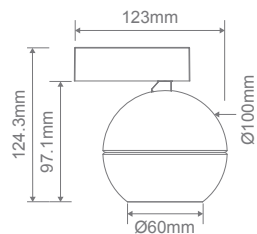

MOON-SM-TUBE

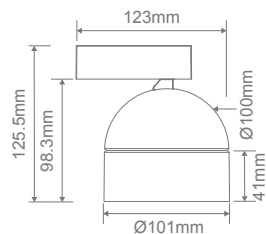

MOON-SM-OPAL

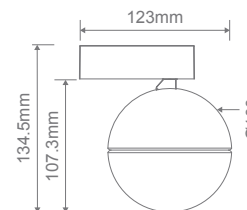

MOON-SM-FLD

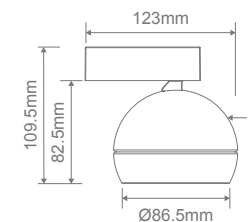

| Item No. | Variants | | Wattage | IP | CCT |
|----------|----------|-------------|---------|----|------|
| | Blk | Wht | | | |
| MOON-SM | FLD | 22812 22813 | 6/9W | 20 | TRIO |
| | OPAL | 22814 22815 | | | |
| | SPOT | 22816 22817 | | | |
| | TUBE | 22818 22819 | | | |



| 6W - Lumen Output | | | | | | | | | | | |
|-------------------|-----------|----------|----------|---------------------|-----------|----------|----------|-------------|-----------|----------|----------|
| Warm White 3000K | | | | Neutral White 4000K | | | | White 5700K | | | |
| Flt-60° | Opal-130° | Spot-30° | Tube-60° | Flt-60° | Opal-130° | Spot-30° | Tube-60° | Flt-60° | Opal-130° | Spot-30° | Tube-60° |
| 477lm | 433lm | 498lm | 430lm | 556lm | 504lm | 534lm | 504lm | 561lm | 513lm | 536lm | 515lm |

| 9W - Lumen Output | | | | | | | | | | | |
|-------------------|-----------|----------|----------|---------------------|-----------|----------|----------|-------------|-----------|----------|----------|
| Warm White 3000K | | | | Neutral White 4000K | | | | White 5700K | | | |
| Flt-60° | Opal-130° | Spot-30° | Tube-60° | Flt-60° | Opal-130° | Spot-30° | Tube-60° | Flt-60° | Opal-130° | Spot-30° | Tube-60° |
| 651lm | 600lm | 661lm | 593lm | 780lm | 719lm | 756lm | 716lm | 775lm | 729lm | 751lm | 708lm |



Neo Pro Surface Mounted Series

- SMD LED Chip.
- Cast Aluminium frame.
- Fully dimmable with suitable dimmers.
- Anti-glare deep set frame, frosted diffuser.
- DALI dimming (Remote Driver) optional extra upon request.



NEO-PRO-13-SM

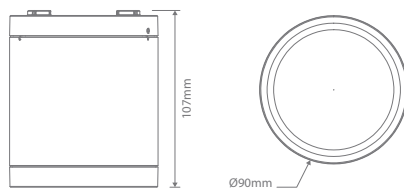

NEO-PRO-25-SM

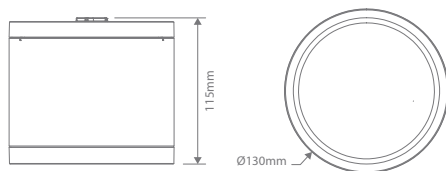

| Item No. | Variants | | Wattage | IP Rating | CCT | Lumen Output | | |
|---------------|----------|-------|---------|-----------|------|--------------|--------|--------|
| | Blk | Wht | | | | 3000K | 4000K | 5700K |
| NEO-PRO-13-SM | 20890 | 20891 | 13W | 65 | TRIO | 1000lm | 1200lm | 1100lm |
| NEO-PRO-25-SM | 20892 | 20893 | 25W | 65 | TRIO | 2200lm | 2400lm | 2300lm |



Neo Pro Surface Mounted Series

- SMD LED Chip.
- Cast Aluminium frame.
- Fully dimmable with suitable dimmers.
- Anti-glare deep set frame, frosted diffuser.
- DALI dimming (Remote Driver) optional extra upon request.



NEO-PRO-35-SM

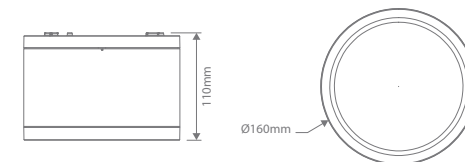

| Item No. | Variants | | Wattage | IP Rating | CCT | Lumen Output | | |
|---------------|----------|-------|---------|-----------|------|--------------|--------|--------|
| | Blk | Wht | | | | 3000K | 4000K | 5700K |
| NEO-PRO-35-SM | 20894 | 20895 | 35W | 65 | TRIO | 3000lm | 3200lm | 3100lm |



Neo Surface Mounted Tilt Series

- COB LED Chip.
- Cast Aluminium frame.
- Adjustable and Directional.
- Fully dimmable with suitable dimmers.
- DALI dimming (Remote Driver) optional extra upon request.



NEO-SM-10-TILT



NEO-SM-10-TILT

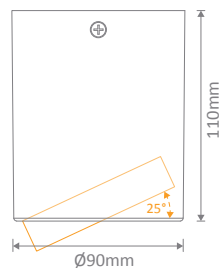

| Item No. | Variants | | Wattage | IP Rating | CCT | Lumen Output | | |
|----------------|----------|-------|---------|-----------|------|------------------|---------------------|-------------|
| | Blk | Wht | | | | Warm White 3000K | Neutral White 4000K | White 5000K |
| NEO-10-SM-TILT | 21294 | 21298 | 10W | 20 | TRIO | 880lm | 960lm | 945lm |



Neo Surface Mounted Tilt Series

- COB LED Chip.
- Cast Aluminium frame.
- Adjustable and Directional.
- Fully dimmable with suitable dimmers.
- DALI dimming (Remote Driver) optional extra upon request.



NEO-SM-20-TILT



NEO-SM-20-TILT

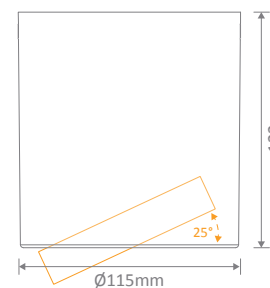

| Item No. | Variants | | Wattage | IP Rating | CCT | Lumen Output | | |
|----------------|----------|-------|---------|-----------|------|------------------|---------------------|-------------|
| | Blk | Wht | | | | Warm White 3000K | Neutral White 4000K | White 5000K |
| NEO-20-SM-TILT | 21296 | 21297 | 20W | 20 | TRIO | 1950lm | 2030lm | 1920lm |



Pistol Series

- COB LED Chip.
- Adjustable and Directional.
- Cast Aluminium frame, powder coated.
- Fully dimmable with suitable dimmers.

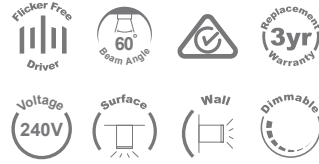

PISTOL-15

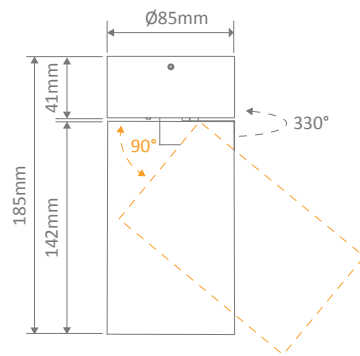

Pistol Series

- COB LED Chip.
- Adjustable and Directional.
- Cast Aluminium frame, powder coated.
- Fully dimmable with suitable dimmers.

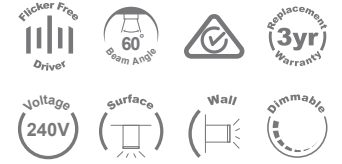

PISTOL-25

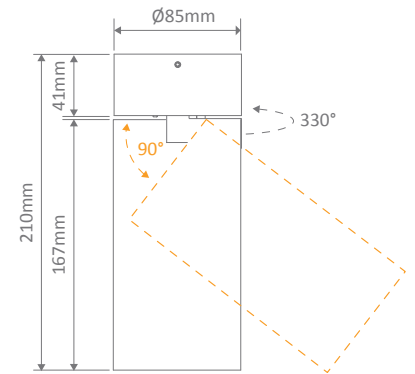

| Item No. | Variants | | Wattage | IP Rating | CCT | Lumen Output | | |
|------------------|--------------|--------------|---------|-----------|------|------------------|---------------------|-------------|
| | Blk | Wht | | | | Warm White 3000K | Neutral White 4000K | White 5000K |
| PISTOL-15 | 20365 | 20366 | 15W | 20 | TRIO | 1230lm | 1420lm | 1385lm |

| Item No. | Variants | | Wattage | IP Rating | CCT | Lumen Output | | |
|------------------|--------------|--------------|---------|-----------|------|------------------|---------------------|-------------|
| | Blk | Wht | | | | Warm White 3000K | Neutral White 4000K | White 5000K |
| PISTOL-25 | 20367 | 20368 | 25W | 20 | TRIO | 2370lm | 2570lm | 2440lm |



LED Filament Series



LF-A60-CLR-E27



LF-A60-FRS-B22

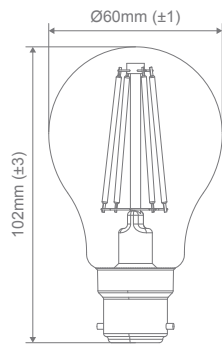
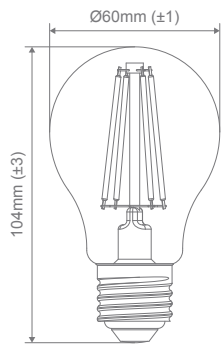

| Item No. | Variants | | Watt | | Watt Equiv. | CCT | Lamp Base | CRI | Lumen Output | | Lifetime |
|----------|----------|-------|------|------|-------------|-------|-----------|-----|--------------|--------|----------|
| | Clr | Frst | Clr | Frst | | | | | Clr | Frst | |
| LF-A60 | 65932 | 65976 | 7.8W | 8.5W | 75W | 2700K | E27 | ≥80 | 1055lm | 1055lm | 15,000h |
| | 65933 | 65977 | | | | 6500K | | | 1050lm | 1055lm | |
| | 65930 | 65974 | | | | 2700K | | | 1055lm | 1055lm | |
| | 65931 | 65975 | | | | 6500K | | | 1050lm | 1055lm | |
| | | | | | | B22 | | | 1050lm | 1055lm | |



LED Filament Series



LF-G95-CLR-E27



LF-G95-FRS-B22

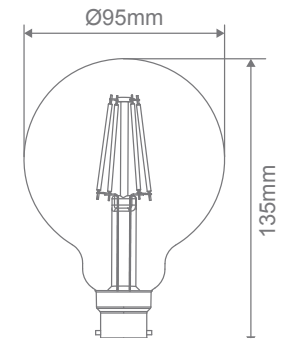
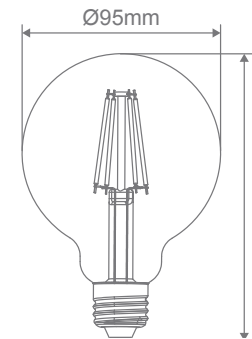

| Item No. | Variants | | Watt | | Watt Equiv. | CCT | Lamp Base | CRI | Lumen Output | | Lifetime |
|----------|----------|-------|------|------|-------------|-------|-----------|-----|--------------|--------|----------|
| | Clr | Frst | Clr | Frst | | | | | Clr | Frst | |
| LF-G95 | 65940 | 65984 | 7.2W | 8.5W | 75W | 2700K | E27 | ≥80 | 806lm | 1055lm | 15,000h |
| | 65941 | 65985 | | | | 6500K | | | 860lm | 1055lm | |
| | 65938 | 65982 | | | | 2700K | | | 806lm | 1055lm | |
| | 65939 | 65983 | | | | 6500K | | | 860lm | 1055lm | |
| | | | | | | B22 | | | 860lm | 1055lm | |



LED Filament Series



LF-G120-CLR-E27



LF-G120-FRS-B22

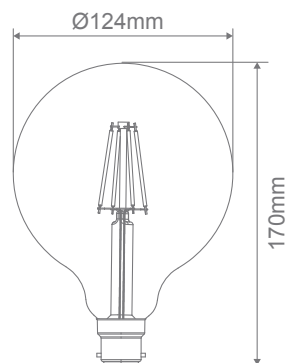
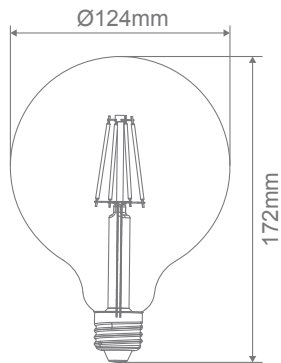

| Item No. | Variants | | Watt | | Watt Equiv. | CCT | Lamp Base | CRI | Lumen Output | | Lifetime |
|----------|----------|-------|------|------|-------------|-------|-----------|-----|--------------|--------|----------|
| | Clr | Frst | Clr | Frst | | | | | Clr | Frst | |
| LF-G120 | 65944 | 65988 | 7.8W | 8.5W | 75W | 2700K | E27 | ≥80 | 1055lm | 1055lm | 15,000h |
| | 65945 | 65989 | | | | | | | 1055lm | 1050lm | |
| | 65942 | 65986 | | | | | | | 1055lm | 1055lm | |
| | 65943 | 65987 | | | | | | | 1055lm | 1050lm | |



LED Filament Series



LF-G45-CLR-E14

LF-G45-FRS-B15



LF-C35-CLR-E14

LF-C35-FRS-B15

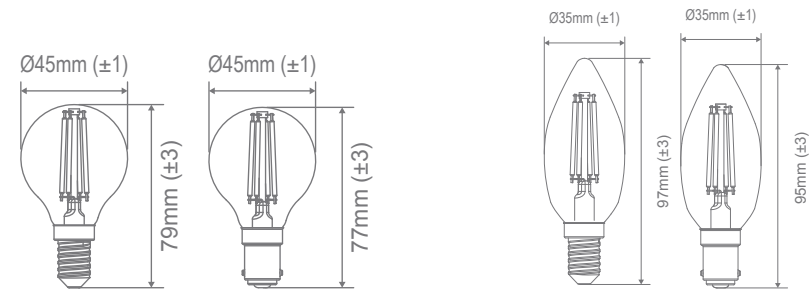

| Item No. | Variants | | Watt | Watt Equiv. | CCT | Lamp Base | CRI | Lumen Output | | Lifetime |
|----------|----------|-------|------|-------------|-------|-----------|-----|--------------|-------|----------|
| | Clr | Frst | | | | | | Clr | Frst | |
| LF-G45 | 65926 | 65970 | 4.2W | 75W | 2700K | E14 | ≥80 | 470lm | 470lm | 15,000h |
| | 65927 | 65971 | | | | | | 500lm | 470lm | |
| | 65928 | 65972 | | | | | | 470lm | 470lm | |
| | 65929 | 65973 | | | | | | 500lm | 470lm | |

| Item No. | Variants | | Watt | Watt Equiv. | CCT | Lamp Base | CRI | Lumen Output | | Lifetime |
|----------|----------|-------|------|-------------|-------|-----------|-----|--------------|-------|----------|
| | Clr | Frst | | | | | | Clr | Frst | |
| LF-C35 | 65924 | 65968 | 4.2W | 75W | 2700K | E14 | ≥80 | 470lm | 470lm | 15,000h |
| | 65925 | 65969 | | | | | | 500lm | 470lm | |
| | 65922 | 65966 | | | | | | 470lm | 470lm | |
| | 65923 | 65967 | | | | | | 500lm | 470lm | |



LED Filament Series

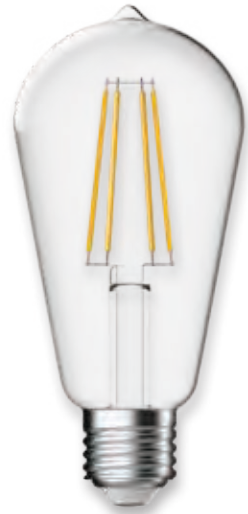

LF-ST64-CLR-E27

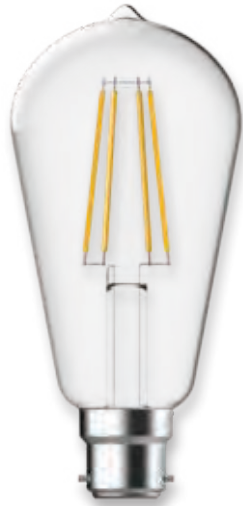

LF-ST64-CLR-B22

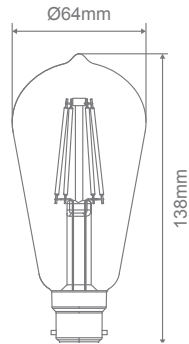
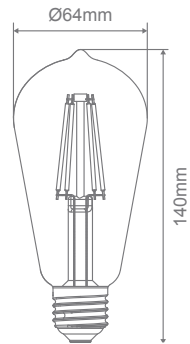

| Item No. | Variants Clr | Watt | Watt Equiv. | CCT | Lamp Base | CRI | Lumen Output | Lifetime |
|----------|-----------------|------|-------------|-------|-----------|-----|--------------|----------|
| LF-ST64 | 65936 | 7.2W | 75W | 2700K | E27 | ≥80 | 806lm | 15,000h |
| | 65937 | | | 6500K | | | 860lm | |
| | 65934 | | | 2700K | B22 | | 806lm | |
| | 65935 | | | 6500K | | | 860lm | |



LED Retro Vintage Filament Lamp



- Banana shape.



LRF-T30-E27

LRF-T30-B22

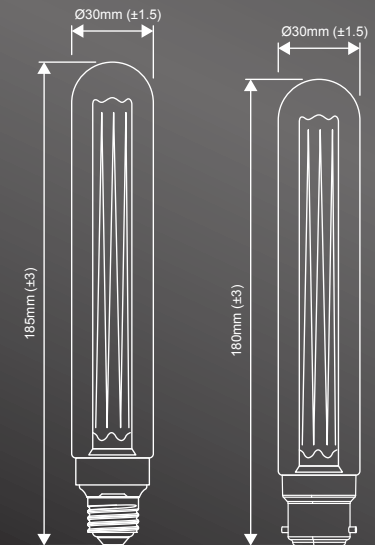

| Item No. | Variants | Watt | CCT | Lamp Base | Lumen Output | Lifetime |
|----------|----------|------|-------|-----------|--------------|-----------|
| LRF-T30 | 65961 | 2.3W | 1800K | E27 | 65lm | 15,000hrs |
| | 65960 | | | B22 | | |



LED Retro Vintage Filament Lamp



- Mini-Banana shape.



LRF-T45-E27

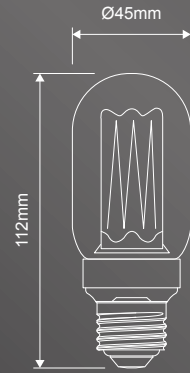

LRF-T45-B22

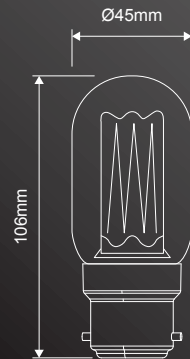

| Item No. | Variants | Watt | CCT | Lamp Base | Lumen Output | Lifetime |
|----------|----------|------|-------|-----------|--------------|-----------|
| LRF-T45 | 65963 | 3.5W | 1800K | E27 | 120lm | 15,000hrs |
| | 65962 | | | B22 | | |



LED Retro Vintage Filament Lamp



- Pear shape.



LRF-ST64-E27



LRF-ST64-B22

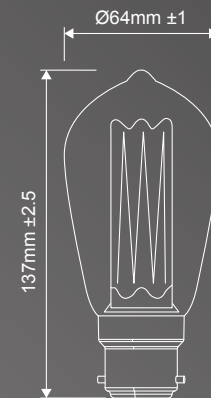
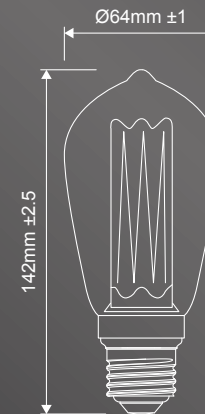

| Item No. | Variants | Watt | CCT | Lamp Base | Lumen Output | Lifetime |
|----------|----------|------|-------|-----------|--------------|-----------|
| LRF-ST64 | 65955 | 3.5W | 1800K | E27 | 120lm | 15,000hrs |
| | 65954 | | | B22 | | |



LED Globes

LED Retro Vintage Filament Lamp



- G95 Spherical shape.



LRF-G95-E27



LRF-G95-B22

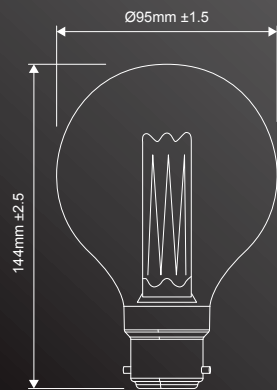
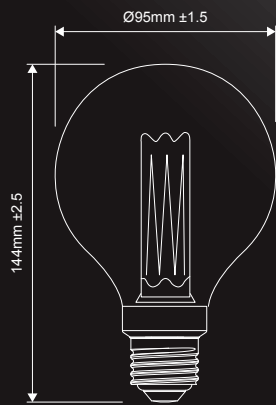

| Item No. | Variants | Watt | CCT | Lamp Base | Lumen Output | Lifetime |
|----------|----------|------|-------|-----------|--------------|-----------|
| LRF-G95 | 65957 | 3.5W | 1800K | E27 | 120lm | 15,000hrs |
| | 65956 | | | B22 | | |



LED Globes

LED Retro Vintage Filament Lamp



- G125 Spherical shape.



LRF-G125-E27



LRF-G125-B22

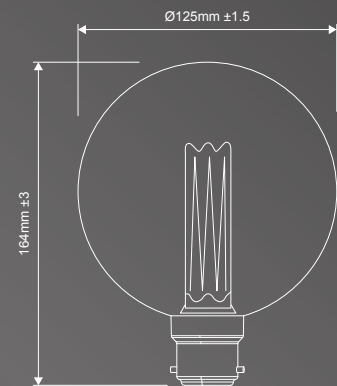
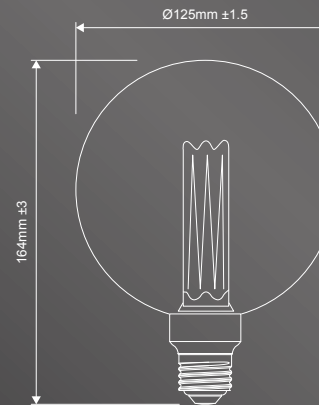

| Item No. | Variants | Watt | CCT | Lamp Base | Lumen Output | Lifetime |
|----------|----------|------|-------|-----------|--------------|-----------|
| LRF-G125 | 65959 | 3.5W | 1800K | E27 | 120lm | 15,000hrs |
| | 65958 | | | B22 | | |

Interior

Interior



Key GLS 12V



- 12V DC Low Voltage LED A60 GLS Globe.
- 12V DC Constant Voltage LED Driver required.

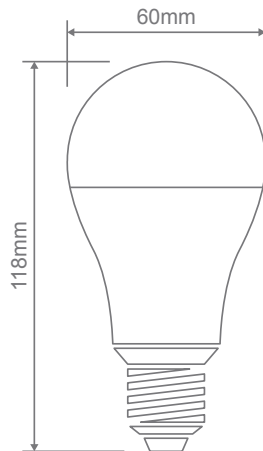

| Item No. | Variants | Watt | Watt Equiv. | CCT | Lamp Base | CRI | Lumen Output | Lifetime |
|-----------------|----------|------|-------------|-------|-----------|-----|--------------|-----------|
| KEY-GLS-E27-12V | 65108 | 8W | 75W | 3000K | E27 | ≥80 | 720lm | 20,000hrs |
| | 65109 | | | 5000K | | | 720lm | |



Key GLS TRIO

- Fully dimmable with suitable dimmers.



Available in these two bases



KEY-GLS-TRIO

| Item No. | Variants | | CCT | Wattage | IP Rating | Lumen Output | | |
|--------------|----------|-------|------|---------|-----------|--------------|---------------|--------|
| | E27 | B22 | | | | Warm White | Neutral White | White |
| KEY-GLS-TRIO | 65114 | 65116 | TRIO | 12W | 20 | 1050lm | 1150lm | 1150lm |



Key G5.3 TRIO

- 4W LED 12V DC G5.3 Base Bi-Pin Lamp
- 12V DC Constant Voltage LED Driver required.

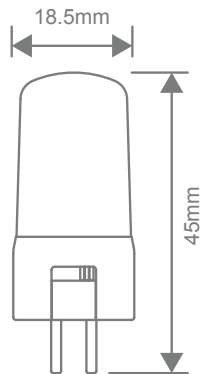

Key G9 TRIO

- Fully dimmable with suitable dimmers.

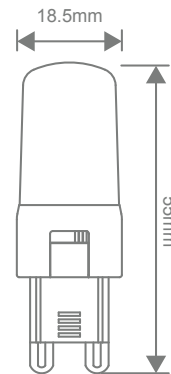

| Item No. | Variant | Watt | Beam Angle | CCT | CRI | Lumen Output | | | Lifetime |
|---------------|---------|------|------------|------|-----|------------------|---------------------|-------------|-----------|
| | | | | | | Warm White 3000K | Neutral White 5000K | White 5000K | |
| KEY-G5.3-TRIO | 65124 | 4W | 280° | TRIO | ≥90 | 330lm | 350lm | 330lm | 50,000hrs |
| KEY-G9-TRIO | 65126 | | | | | 330lm | 350lm | 330lm | |



Key G9

- Fully dimmable with suitable dimmers.



| Item No. | Variants | | Watt | Beam Angle | CCT | CRI | Lumen Output | | Lifetime |
|----------|----------|-------|------|------------|---------------|-----|------------------|-------------|-----------|
| | 3000K | 5000K | | | | | Warm White 3000K | White 5000K | |
| KEY-G9 | 65104 | 65106 | 3.5W | 280° | 3000K - 5000K | ≥80 | 280lm | 300lm | 15,000hrs |



Key MR11-3

- MR11 shape G5.3 base.
- 38° Beam Angle.
- 12V DC Constant Voltage LED Driver required.

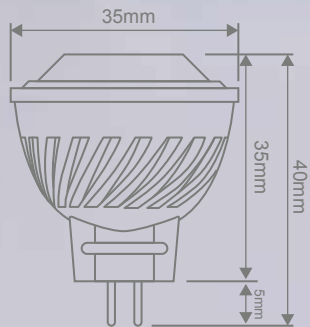

| Item No. | Variant | | Watt | Beam Angle | CCT | CRI | Lumen Output | | Lifetime |
|----------|---------|-------|------|------------|---------------|-----|------------------|----------------|-----------|
| | 3000K | 6000K | | | | | Warm White 3000K | Daylight 6000K | |
| KEY-MR11 | 65016 | 65017 | 3W | 38° | 3000K - 6000K | ≥80 | 240lm | 240lm | 35,000hrs |



Key MR16 Glass

- MR16 shape GU5.3 base.
- 60° Beam Angle.
- 12V DC Constant Voltage LED Driver required.

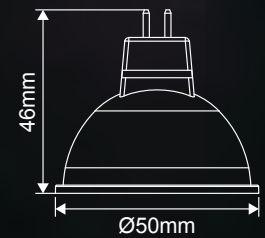

| Item No. | Variant | | Watt | Beam Angle | CCT | CRI | Lumen Output | | Lifetime |
|----------------|---------|-------|------|------------|---------------|-----|------------------|-------------|-----------|
| | 3000K | 5000K | | | | | Warm White 3000K | White 5000K | |
| KEY-MR16-GLASS | 65100 | 65102 | 4.7W | 60° | 3000K - 5000K | ≥80 | 390lm | 420lm | 15,000hrs |



Key GU10 Glass

- GU10 shape.
- 60° Beam Angle.

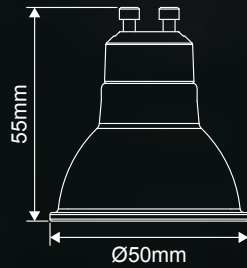

| Item No. | Variant | | Watt | Beam Angle | CCT | CRI | Lumen Output | | Lifetime |
|----------------|---------|-------|------|------------|---------------|-----|------------------|-------------|-----------|
| | 3000K | 5000K | | | | | Warm White 3000K | White 5000K | |
| KEY-GU10-GLASS | 65096 | 65098 | 6.2W | 60° | 3000K - 5000K | ≥80 | 520lm | 540lm | 15,000hrs |



Key MR16 & GU10 TRIO



- 12V DC Constant Voltage LED Driver required.



KEY-MR16-TRIO



KEY-GU10-TRIO

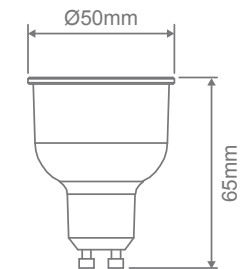
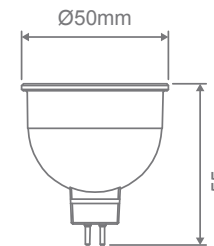

| Item No. | Variants | Watt | Beam Angle | CCT | CRI | Lumen Output | | | Lifetime |
|---------------|----------|------|------------|------|-----|------------------|---------------------|-------------|-----------|
| | | | | | | Warm White 3000K | Neutral White 4000K | White 6500K | |
| KEY-GU10-TRIO | 65112 | 6W | 60° | TRIO | ≥80 | 500lm | 550lm | 550lm | 15,000hrs |
| KEY-MR16-TRIO | 65122 | | | | | | | | |



Key T40 TRIO

- Fully dimmable with suitable dimmers.



KEY-T40-TRIO-E27



KEY-T40-TRIO-B22

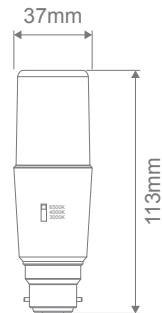
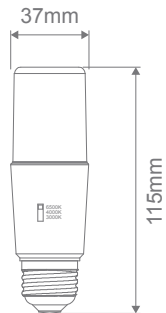

| Item No. | Variants | | Watt | Beam Angle | CCT | CRI | Lumen Output | | | Lifetime |
|--------------|----------|-------|------|------------|------|-----|------------------|---------------------|-------------|-----------|
| | E27 | B22 | | | | | Warm White 3000K | Neutral White 4000K | White 6500K | |
| KEY-T40-TRIO | 65118 | 65120 | 8W | 220° | TRIO | ≥80 | 650lm | 720lm | 720lm | 15,000hrs |



Key-PAR Series



KEY-PAR-30



KEY-PAR-38

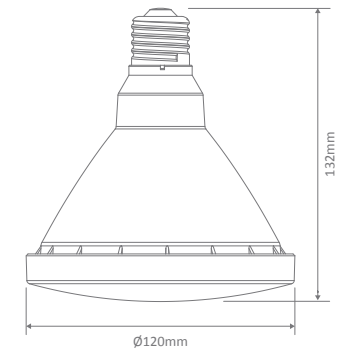
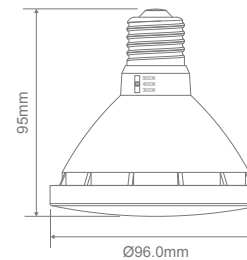

| Item No. | Variants | Watt | Watt Equiv. | IP Rating | CCT | Cap | CRI | Lumen Output | | | Lifetime |
|------------|----------|------|-------------|-----------|-------|-----|-----|--------------|--------|-------|-----------|
| KEY-PAR-30 | 65130 | 10W | 75W | 65 | 3000K | E27 | ≥80 | 900lm | 1000lm | 950lm | 30,000hrs |

| Item No. | Variants | Watt | Watt Equiv. | IP Rating | CCT | Cap | CRI | Lumen Output | | Lifetime |
|------------|----------|------|-------------|-----------|--------|-----|-----|--------------|--|-----------|
| KEY-PAR-38 | 65195 | 16W | 90W | 44 | 3000K | E27 | ≥80 | 1350lm | | 30,000hrs |
| | 65197 | | | | 1400lm | | | | | |



How to build a profile

1- Choose your application and profile



2- Finish colour

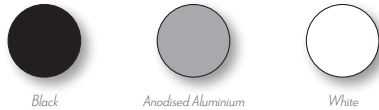

3- Measure the area of application



4- Choose the desired light output

(wattage and colour temperature from selected range "LED Strip")



5- Choose your driver

(from selected range "LED Drivers")

$$twr = wpm \times l + 20\%$$

| | |
|-------|------------------------|
| twr = | total wattage required |
| wpm = | watts per metre |
| l = | length |

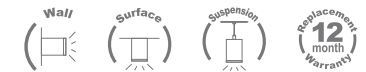

Bloc 20

Specification

| | |
|----------------------|---|
| Installation: | Surface, wall or suspension mounted |
| Material: | Extruded Aluminium 6063 |
| Finish: | Natural clear anodised, Black or White |
| Diffuser: | Square (PMMA) Opal colour |
| Length: | 2500mm continuous* |
| Size: | Profile (W) 19.7mm, (H) 19.6mm |
| Accessories: | Wire suspensions** |
| Special: | Custom powder coated colour upon request*** |
| Driver installation: | Remote driver required |

* Profile sold per metre. Can be cut to suit any length up to 2.5m. Includes endcaps & mounting clips.

** Accessories to be ordered separately.

*** Special powder coat finishes upon request. Surcharges apply.

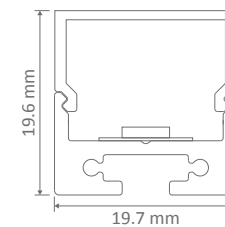

Aluminium



White



Suspension Kit

Compatible PLEX-COB LED Strip

| 5W | 10W | 15W | 20W |
|----|-----|-----|-----|
| • | • | • | • |

| Item No | Variants | | | Details |
|-------------|----------|-------|-------|---|
| | Blk | Alu | Wht | |
| BLOC-20-SM | 22068 | 22010 | 22069 | Sold per 1 metre |
| SUSP-KIT-2M | | 22041 | | 2 Metres standard height, sold individually |



Curve 20

Specification

| | |
|----------------------|---|
| Installation: | Surface, wall or suspension mounted |
| Material: | Extruded Aluminium 6063 |
| Finish: | Natural clear anodised, Black or White |
| Diffuser: | Curved (PMMA) Opal colour |
| Length: | 2500mm continuous* |
| Size: | Profile (W) 19.7mm (H) 19.6mm |
| Accessories: | Wire suspensions** |
| Special: | Custom powder coated colour upon request*** |
| Driver | Remote driver required |

* Profile sold per metre. Can be cut to suit any length up to 2.5m. Endcaps & mounting clips.

** Accessories to be ordered separately.

*** Special powder coat finishes upon request. Surcharges apply.

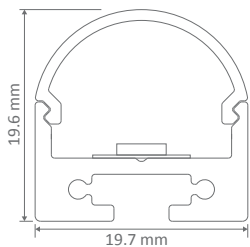

Aluminium



White



Suspension Kit

Compatible PLEX-COB LED Strip

| 5W | 10W | 15W | 20W |
|----|-----|-----|-----|
| • | • | • | • |

| Profile | Variants | | | Details |
|-------------|----------|-------|-------|---|
| | Blk | Alu | Wht | |
| CURVE-20-SM | 22066 | 22008 | 22067 | Sold per 1 metre |
| SUSP-KIT-2M | | 22041 | | 2 Metres standard height, sold individually |

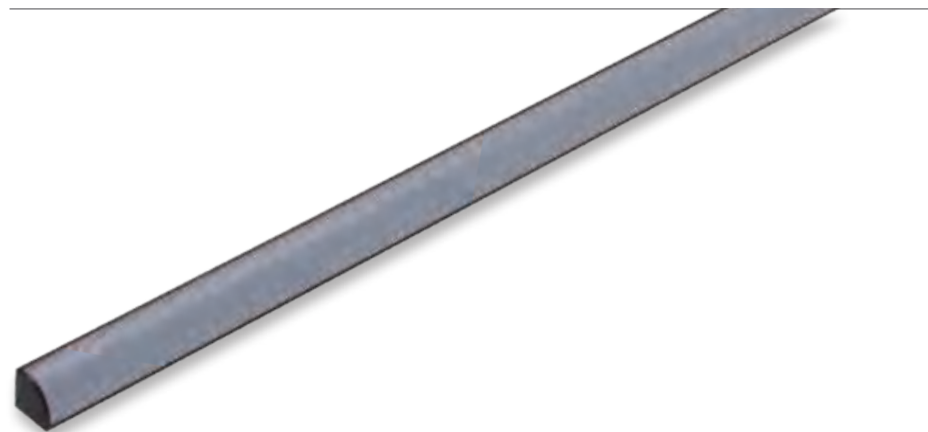

Corner 16 RND

Specification:

| | |
|-----------------------------|--|
| Installation: | Surface mounted |
| Material: | Extruded Aluminium 6063 |
| Finish: | Natural clear anodised, Black or White |
| Diffuser: | Curved (PMMA) Opal/Frost colour |
| Length: | 2500mm continuous* |
| Size: | Profile (W) 16mm, (H) 16mm |
| Special: | Custom powder coated colour upon request** |
| Driver installation: | Remote driver required |

* Profile sold per metre. Can be cut to suit any length up to 2.5m. Includes endcaps & mounting clips.

** Special powder coat finishes upon request. Surcharges apply.

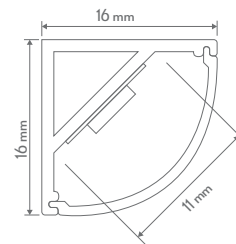

Compatible PLEX-COB LED Strip

| 5W | 10W | 15W | 20W |
|----|-----|-----|-----|
| • | • | • | • |

*Does not fit the IP67 version of this strip



Simulation



Aluminium



White

| Profile | Variants | | | Details |
|---------------|----------|-------|-------|------------------|
| | Blk | Alu | Wht | |
| CORNER-16-RND | 22070 | 22026 | 22071 | Sold per 1 metre |

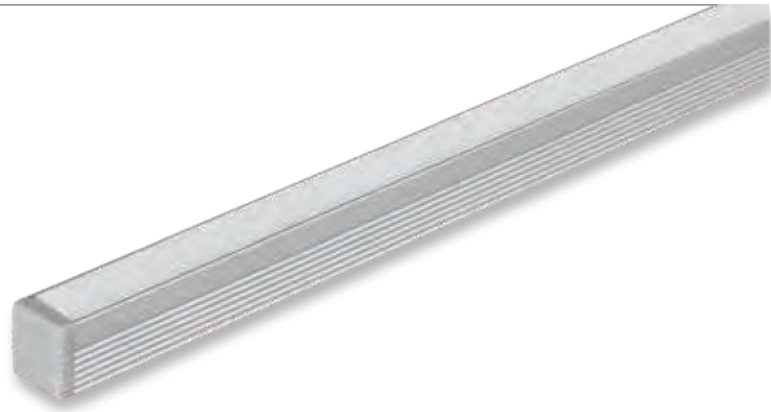

Micro SM

| | |
|-----------------------------|--|
| Specification | |
| Installation: | Surface or wall mounted |
| Material: | Extruded Aluminium 6063 |
| Finish: | Natural clear anodised, Black or White |
| Diffuser: | Flat (PMMA) High Output Opal/Frost colour |
| Length: | 2000mm continuous* |
| Size: | Profile (W) 8mm, (H) 9mm |
| Special: | Custom powder coated colour upon request** |
| Driver installation: | Remote driver required |

* Profile sold per metre. Can be cut to suit any length up to 2m. Includes Endcaps & mounting clips.
 ** Special powder coat finishes upon request. Surcharges apply.



| Profile | Variants | | | Details |
|-----------------|----------|-------|-------|------------------|
| | Blk | Alu | Wht | |
| MICRO-SM | 21941 | 21940 | 21942 | Sold per 1 metre |

Compatible with PLEX-MICRO-8W LED Strip

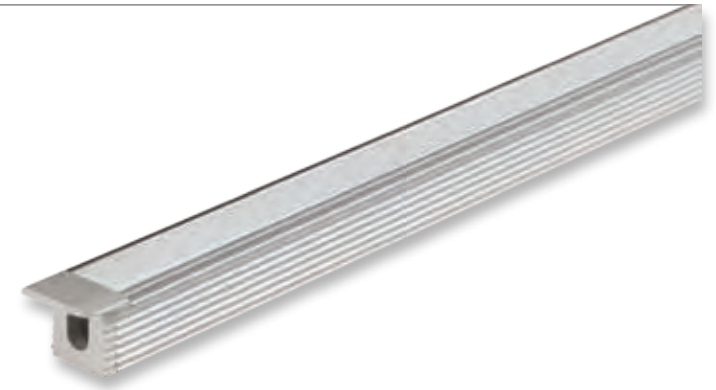

Micro REC

| | |
|-----------------------------|--|
| Specification | |
| Installation: | Recess mounted |
| Material: | Extruded Aluminium 6063 |
| Finish: | Natural clear anodised, Black or White |
| Diffuser: | Flat (PMMA) High Output Opal/Frost colour |
| Length: | 3000mm continuous* |
| Size: | Profile (W) 10.9mm, (H) 9.1mm |
| Special: | Custom powder coated colour upon request** |
| Driver installation: | Remote driver required |

* Profile sold per metre. Can be cut to suit any length up to 3m. Includes endcaps.
 ** Special powder coat finishes upon request. Surcharges apply.



| Profile | Variants | | | Details |
|------------------|----------|-------|-------|------------------|
| | Blk | Alu | Wht | |
| MICRO-REC | 21957 | 21956 | 21958 | Sold per 1 metre |

Compatible with PLEX-MICRO-8W LED Strip

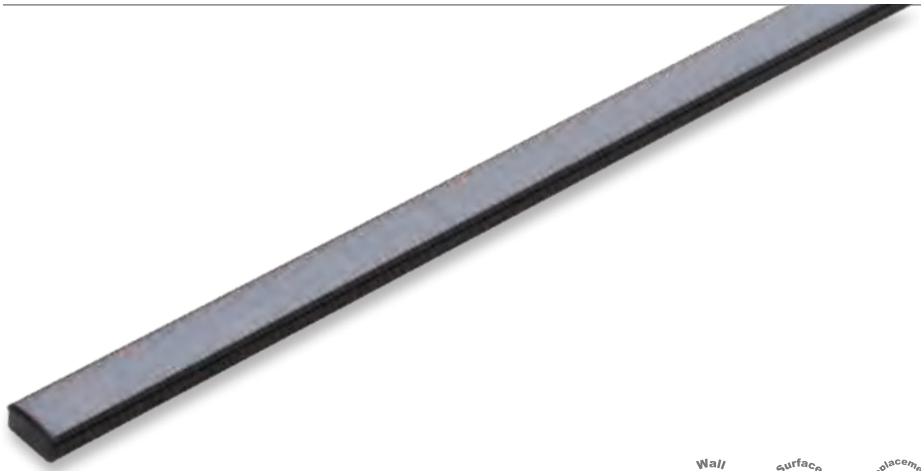

Nova 17 SM

| | |
|-----------------------------|--|
| Specification | |
| Installation: | Surface or wall mounted |
| Material: | Extruded Aluminium 6063 |
| Finish: | Natural clear anodised, Black or White |
| Diffuser: | Flat (PMMA) High Output Opal/Frost colour |
| Length: | 3000mm continuous* |
| Size: | Profile (W) 17mm, (H) 8mm |
| Special: | Custom powder coated colour upon request** |
| Driver installation: | Remote driver required |

* Profile sold per metre. Can be cut to suit any length up to 3m. Includes Endcaps & mounting clips.
 ** Special powder coat finishes upon request. Surcharges apply.

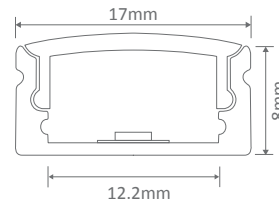

Aluminium White

Compatible PLEX-COB LED Strip

| 5W | 10W | 15W | 20W |
|----|-----|-----|-----|
| • | • | • | • |

*Does not fit the IP67 version of this strip

| Profile | Length | Variants | | |
|------------|---------|----------|-------|-------|
| | | Blk | Alu | Wht |
| NOVA-17-SM | 1 Metre | 22078 | 22045 | 22079 |
| | 3 Metre | 22013 | 22102 | 22104 |



Nova 17 REC

| | |
|-----------------------------|--|
| Specification | |
| Installation: | Recess mounted |
| Material: | Extruded Aluminium 6063 |
| Finish: | Natural clear anodised, Black or White |
| Diffuser: | Flat (PMMA) High Output Opal/Frost colour |
| Length: | 3000mm continuous* |
| Size: | Profile (W) 23mm, (H) 8mm |
| Special: | Custom powder coated colour upon request** |
| Driver installation: | Remote driver required |

* Profile sold per metre. Can be cut to suit any length up to 3m. Includes endcaps.
 ** Special powder coat finishes upon request. Surcharges apply.

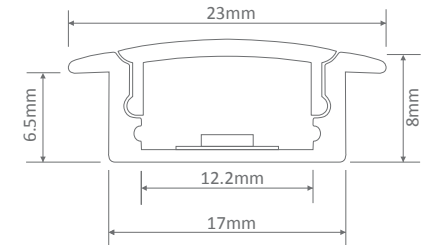

Simulation Aluminium White

Compatible PLEX-COB LED Strip

| 5W | 10W | 15W | 20W |
|----|-----|-----|-----|
| • | • | • | • |

*Does not fit the IP67 version of this strip

| Profile | Length | Variants | | |
|-------------|---------|----------|-------|-------|
| | | Blk | Alu | Wht |
| NOVA-17-REC | 1 Metre | 22092 | 22048 | 22093 |
| | 3 Metre | 22108 | 22107 | 22109 |



Nova 20 SM

Specification

| | |
|-----------------------------|--|
| Installation: | Surface or wall mounted |
| Material: | Extruded Aluminium 6063 |
| Finish: | Natural clear anodised, Black or White |
| Diffuser: | Flat (PMMA) high output opal/frost |
| Length: | 3000mm continuous* |
| Size: | Profile (W) 20mm (H) 10mm |
| Special: | Custom powder coated colour upon request** |
| Driver installation: | Remote driver required |

* Profile sold per metre. Can be cut to suit any length up to 3m. Includes Endcaps & mounting clips.

** Special powder coat finishes upon request. Surcharges apply.

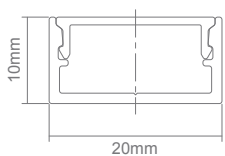

Compatible PLEX-COB LED Strip

| 5W | 10W | 15W | 20W |
|----|-----|-----|-----|
| • | • | • | • |

| Profile | Length | Variants | | |
|------------|---------|----------|-------|-------|
| | | Blk | Alu | Wht |
| NOVA-20-SM | 1 Metre | 22938 | 22937 | 22939 |
| | 3 Metre | 22930 | 22929 | 22931 |



Nova 20 REC

Specification

| | |
|-----------------------------|--|
| Installation: | Recess mounted |
| Material: | Extruded aluminium 6063 |
| Finish: | Natural clear anodised |
| Diffuser: | Flat (PMMA) high output opal/frost |
| Length: | 3000mm continuous* |
| Size: | Profile (W) 28mm (H) 10mm |
| Special: | Custom powder coated colour upon request** |
| Driver installation: | Remote driver required |

* Profile sold per metre. Can be cut to suit any length up to 3m. Includes endcaps.

** Special powder coat finishes upon request. Surcharges apply.

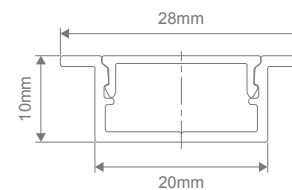

Compatible PLEX-COB LED Strip

| 5W | 10W | 15W | 20W |
|----|-----|-----|-----|
| • | • | • | • |

| Profile | Length | Variants | | |
|-------------|---------|----------|-------|-------|
| | | Blk | Alu | Wht |
| NOVA-20-REC | 1 Metre | 22942 | 22941 | 22943 |
| | 3 Metre | 22934 | 22933 | 22935 |



Nova 24 SM

Specification

| | |
|-----------------------------|--|
| Installation: | Surface or Wall mounted |
| Material: | Extruded Aluminium 6063 |
| Finish: | Natural clear anodised, Black or White |
| Diffuser: | Flat (PMMA) high output opal/frost |
| Length: | 3000mm continuous* |
| Size: | Profile (W) 23.5mm (H) 11mm |
| Special: | Custom powder coated colour upon request** |
| Driver installation: | Remote driver required |

* Profile sold per metre. Can be cut to suit any length up to 3m. Includes Endcaps & mounting clips.
 ** Special powder coat finishes upon request. Surcharges apply.

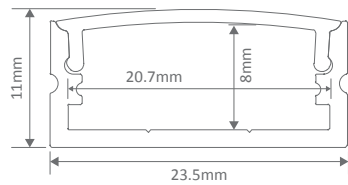

Compatible PLEX-COB LED Strip

| 5W | 10W | 15W | 20W |
|----|-----|-----|-----|
| • | • | • | • |

| Profile | Length | Variants | | |
|------------|---------|----------|-------|-------|
| | | Blk | Alu | Wht |
| NOVA-24-SM | 1 Metre | 22435 | 22434 | 22436 |
| | 3 Metre | 22958 | 22957 | 22959 |

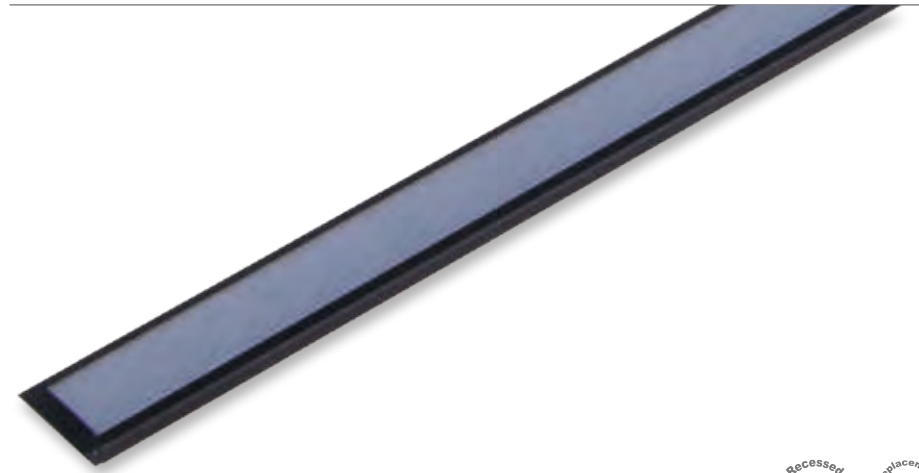

Nova 24 REC

Specification

| | |
|-----------------------------|--|
| Installation: | Recess mounted |
| Material: | Extruded aluminium 6063 |
| Finish: | Natural clear anodised |
| Diffuser: | Flat (PMMA) high output opal/frost |
| Length: | 3000mm continuous* |
| Size: | Profile (W) 30.5mm (H) 11mm |
| Special: | Custom powder coated colour upon request** |
| Driver installation: | Remote driver required |

* Profile sold per metre. Can be cut to suit any length up to 3m. Includes endcaps.
 ** Special powder coat finishes upon request. Surcharges apply.

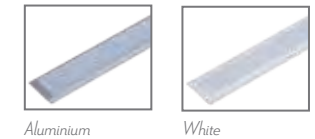
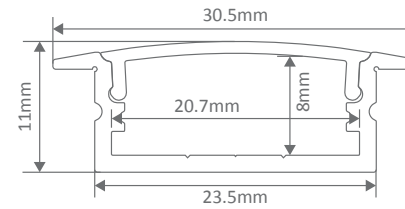

Compatible PLEX-COB LED Strip

| 5W | 10W | 15W | 20W |
|----|-----|-----|-----|
| • | • | • | • |

| Profile | Length | Variants | | |
|-------------|---------|----------|-------|-------|
| | | Blk | Alu | Wht |
| NOVA-24-REC | 1 Metre | 22431 | 22430 | 22432 |
| | 3 Metre | 22962 | 22961 | 22963 |



Omega 17 SM

| | |
|-----------------------------|--|
| Specification | |
| Installation: | Surface or Wall mounted |
| Material: | Extruded Aluminium 6063 |
| Finish: | Natural clear anodised, Black or White |
| Diffuser: | Flat (PMMA) high output Frost colour |
| Length: | 3000mm continuous* |
| Size: | Profile (W) 17mm, (H) 15.2mm |
| Special: | Custom powder coated colour upon request** |
| Driver installation: | Remote driver required |

* Profile sold per metre. Can be cut to suit any length up to 3m. Includes endcaps.
 ** Special powder coat finishes upon request. Surcharges apply.

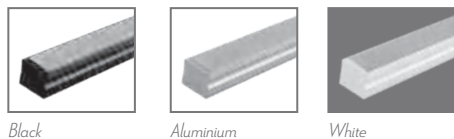
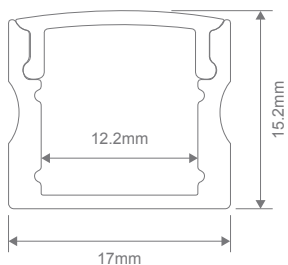

Compatible PLEX-COB LED Strip

| 5W | 10W | 15W | 20W |
|----|-----|-----|-----|
| • | • | • | • |

*Does not fit the IP67 version of this strip

| Profile | Length | Variants | | |
|-------------|---------|----------|-------|-------|
| | | Blk | Alu | Wht |
| OMEGA-17-SM | 1 Metre | 22127 | 22126 | 22128 |
| | 3 Metre | 22112 | 22111 | 22113 |



Bloc 42

| | |
|-----------------------------|---|
| Specification | |
| Installation: | Surface, wall or suspension mounted |
| Material: | Extruded Aluminium 6063 |
| Finish: | Natural clear anodised, Black or White |
| Diffuser: | Wrap around (PMMA) Frost colour |
| Length: | 2500mm continuous* |
| Size: | Profile (W) 42.5mm, (H) 56mm |
| Accessories: | Wire suspensions** |
| Special: | Custom powder coated colour upon request*** |
| Driver installation: | Remote or integral driver required |

* Profile sold per metre. Can be cut to suit any length up to 2.5m. Includes endcaps.
 ** Accessories to be ordered separately.
 *** Special powder coat finishes upon request. Surcharges apply.

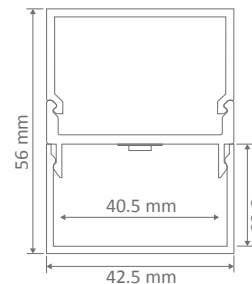

Compatible PLEX-COB LED Strip

| 5W | 10W | 15W | 20W |
|----|-----|-----|-----|
| • | • | • | • |

| Profile | Variants | | | Details |
|-------------|----------|-------|-------|---|
| | Blk | Alu | Wht | |
| BLOC-42 | 22294 | 22020 | 22295 | Sold per 1 metre |
| SUSP-KIT-2M | | 22041 | | 2 Metres standard height, sold individually |



Omega 35 SM

| | |
|-----------------------------|---|
| Specification | |
| Installation: | Surface, wall or suspension mounted |
| Material: | Extruded Aluminium 6063 |
| Finish: | Natural clear anodised, Black or White |
| Diffuser: | Flat (PMMA) high output Frost colour |
| Length: | 2500mm continuous* |
| Size: Profile | Profile (W) 34.8mm, (H) 37.5mm |
| Accessories: | Wire suspensions** |
| Special: | Custom powder coated colour upon request*** |
| Driver installation: | Remote driver required |

* Profile sold per metre. Can be cut to suit any length up to 2.5m. Includes endcaps.
 ** Accessories to be ordered separately.
 *** Special powder coat finishes upon request. Surcharges apply.

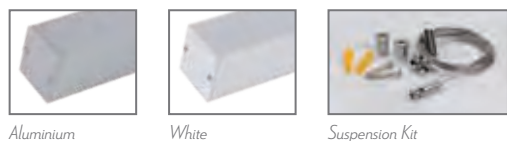
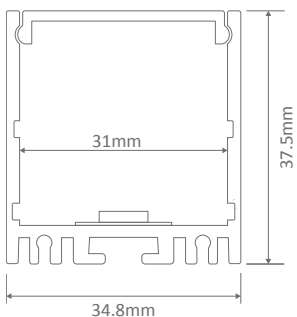

Compatible PLEX-COB LED Strip

| 5W | 10W | 15W | 20W |
|----|-----|-----|-----|
| • | • | • | • |

| Profile | Variants | | | Details |
|-------------|----------|-------|-------|---|
| | Blk | Alu | Wht | |
| OMEGA-35-SM | 22076 | 22050 | 22077 | Sold per 1 metre |
| SUSP-KIT-2M | | 22041 | | 2 Metres standard height, sold individually |



Omega 35 REC

| | |
|-----------------------------|--|
| Specification | |
| Installation: | Recess mounted |
| Material: | Extruded Aluminium 6063 |
| Finish: | Natural clear anodised, Black or White. |
| Diffuser: | Flat (PMMA) high output Frost colour |
| Length: | 2500mm continuous* |
| Size: | Profile (W) 43.8mm, (H) 34.8mm |
| Special: | Custom powder coated colour upon request** |
| Driver installation: | Remote driver required |

* Profile sold per metre. Can be cut to suit any length up to 2.5m. Includes endcaps & mounting clips.
 ** Special powder coat finishes upon request. Surcharges apply.

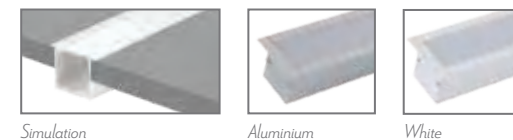
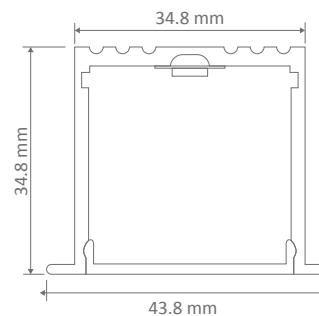

Compatible PLEX-COB LED Strip

| 5W | 10W | 15W | 20W |
|----|-----|-----|-----|
| • | • | • | • |

| Profile | Variants | | | Details |
|--------------|----------|-------|-------|------------------|
| | Blk | Alu | Wht | |
| OMEGA-35-REC | 22074 | 22034 | 22075 | Sold per 1 metre |

Plex COB 5



- True Dotless Technology
- Reduced Welded Joints
- Connector and Joiner Accessories available

| | |
|------------------------------|------------------------------------|
| Specification: | |
| Colours: | 3 colour temperatures |
| Light Source: | COB LED |
| Colour Temperature: | 3000K, 4000K & 5000K |
| CRI: | ≥90 |
| Number of LED Per Metre: | 640 |
| Wattage Per Metre: | 5W |
| Input Voltage: | 24V DC |
| Beam angle: | 180° |
| Wiring: | Parallel |
| IP Rating: | IP54** |
| Cutting Increments/Sections: | 25mm |
| Requires: | 24V DC Constant Voltage LED Driver |
| Dimmable: | Yes*** |
| IES files: | Yes |
| Continuous Run: | 10m Max |

* With the use of Domus drivers
 * All LED strip must be installed on an aluminium heat sink, failure to do so WILL VOID WARRANTY.
 ** Indoor Use Only - Suitable for indoor wet areas.
 *** Fully dimmable with suitable dimmers.



5 Metre 20 Metre 50 Metre

| Item No. | Variants | | | CCT | Lumen Output | Colour Simulation |
|------------|----------|-------|-------|-------|--------------|-------------------|
| | Per Mt | 20M | 50M | | | |
| PLEX-COB-5 | 24000 | 24014 | 24028 | 3000K | 450lm/m | Warm White |
| | 24001 | 24015 | 24029 | 4000K | 500lm/m | Neutral White |
| | 24002 | 24016 | 24030 | 5000K | 500lm/m | White |

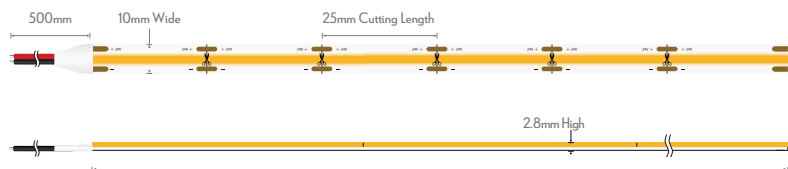

Plex COB 10



- True Dotless Technology
- Reduced Welded Joints
- Connector and Joiner Accessories available

| | |
|------------------------------|------------------------------------|
| Specification: | |
| Colours: | 3 colour temperatures |
| Light Source: | COB LED |
| Colour Temperature: | 3000K, 4000K & 5000K |
| CRI: | ≥90 |
| Number of LED Per Metre: | 640 |
| Wattage Per Metre: | 10W |
| Input Voltage: | 24V DC |
| Beam angle: | 180° |
| Wiring: | Parallel |
| IP Rating: | IP54** |
| Cutting Increments/Sections: | 25mm |
| Requires: | 24V DC Constant Voltage LED Driver |
| Dimmable: | Yes*** |
| IES files: | Yes** |
| Continuous Run: | 5m Max |

* With the use of Domus drivers
 * All LED strip must be installed on an aluminium heat sink, failure to do so WILL VOID WARRANTY.
 ** Indoor Use Only - Suitable for indoor wet areas.
 *** Fully dimmable with suitable dimmers.



5 Metre 20 Metre 50 Metre

| Item No. | Variants | | | CCT | Lumen Output | Colour Simulation |
|-------------|----------|-------|-------|-------|--------------|-------------------|
| | Per Mt | 20M | 50M | | | |
| PLEX-COB-10 | 24003 | 24017 | 24031 | 3000K | 900lm/m | Warm White |
| | 24004 | 24018 | 24032 | 4000K | 900lm/m | Neutral White |
| | 24005 | 24019 | 24033 | 5000K | 1000lm/m | White |

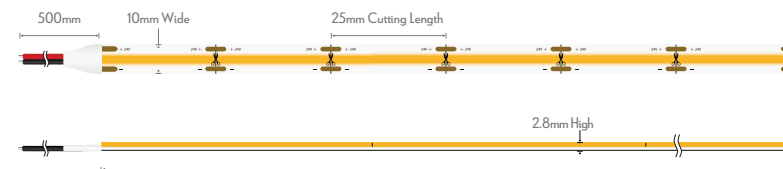

Plex COB 15



- True Dotless Technology
- Reduced Welded Joints
- Connector and Joiner Accessories available

Specification:

| | |
|------------------------------|------------------------------------|
| Colours: | 3 colour temperatures |
| Light Source: | COB LED |
| Colour Temperature: | 3000K, 4000K & 5000K |
| CRI: | ≥90 |
| Number of LED Per Metre: | 640 |
| Wattage Per Metre: | 15W |
| Input Voltage: | 24V DC |
| Beam angle: | 180° |
| Wiring: | Parallel |
| IP Rating: | IP54** |
| Cutting Increments/Sections: | 25mm |
| Requires: | 24V DC Constant Voltage LED Driver |
| Dimmable: | Yes*** |
| IES files: | Yes** |
| Continuous Run: | 5 m Max |

* With the use of Domus drivers

* All LED strip must be installed on an aluminium heat sink, failure to do so WILL VOID WARRANTY.

** Indoor Use Only - Suitable for indoor wet areas.

*** Fully dimmable with suitable dimmers.



5 Metre 20 Metre 50 Metre

| Item No. | Variants | | | CCT | Lumen Output | Colour Simulation |
|-------------|----------|-------|-------|-------|--------------|-------------------|
| | Per Mt | 20M | 50M | | | |
| PLEX-COB-15 | 24006 | 24020 | 24034 | 3000K | 1350lm/m | Warm White |
| | 24007 | 24021 | 24035 | 4000K | 1500lm/m | Neutral White |
| | 24008 | 24022 | 24036 | 5000K | 1500lm/m | White |

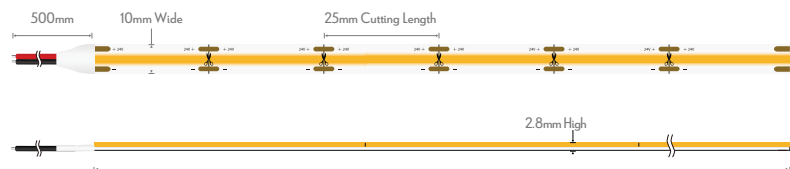

Plex COB 20



- True Dotless Technology
- Reduced Welded Joints
- Connector and Joiner Accessories available

Specification:

| | |
|------------------------------|------------------------------------|
| Colours: | 3 colour temperatures |
| Light Source: | COB LED |
| Colour Temperature: | 3000K, 4000K & 5000K |
| CRI: | ≥90 |
| Number of LED Per Metre: | 640 |
| Wattage Per Metre: | 20W |
| Input Voltage: | 24V DC |
| Beam angle: | 180° |
| Wiring: | Parallel |
| IP Rating: | IP54** |
| Cutting Increments/Sections: | 25mm |
| Requires: | 24V DC Constant Voltage LED Driver |
| Dimmable: | Yes*** |
| IES files: | Yes** |
| Continuous Run: | 3m Max |

* With the use of Domus drivers

* All LED strip must be installed on an aluminium heat sink, failure to do so WILL VOID WARRANTY.

** Indoor Use Only - Suitable for indoor wet areas.

*** Fully dimmable with suitable dimmers.



5 Metre 20 Metre 50 Metre

| Item No. | Variants | | | CCT | Lumen Output | Colour Simulation |
|-------------|----------|-------|-------|-------|--------------|-------------------|
| | Per Mt | 20M | 50M | | | |
| PLEX-COB-20 | 24009 | 24023 | 24037 | 3000K | 1800lm/m | Warm White |
| | 24010 | 24024 | 24038 | 4000K | 2000lm/m | Neutral White |
| | 24011 | 24025 | 24039 | 5000K | 2000lm/m | White |

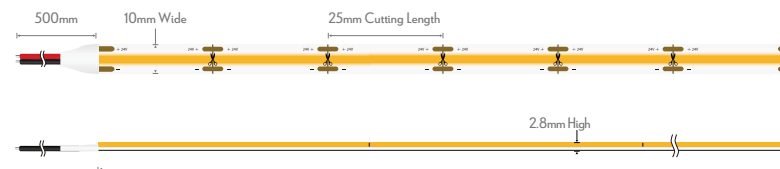

STRIP-COB-KIT-3000K

Strip COB Kit



- True Dotless Technology
- Reduced Welded Joints

Specification:

| | |
|--------------------------|-----------------------|
| Colours: | 2 colour temperatures |
| Light Source: | COB LED |
| Colour Temperature: | 3000K & 4000K |
| CRI: | ≥90 |
| Number of LED Per Metre: | 608 |
| Wattage Per Metre: | 6W |
| Input Voltage: | 24V DC |
| Beam angle: | 120° |
| IP Rating: | IP44 |
| Dimmable: | No |



| Item No. | Variants | | CCT | Lumen Output | |
|---------------|----------|-------|-------------|--------------|-------|
| | 2M | 5M | | 3000K | 4000K |
| STRIP-COB-KIT | 23900 | 23901 | 3000K-4000K | 610lm | 715lm |

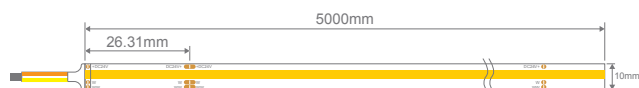

PLEX-COB-5-IP67-3K

PLEX-COB-10-IP67-3K

Plex COB 5 IP67



- True Dotless Technology
- Reduced Welded Joints

Specification:

| | |
|------------------------------|------------------------------------|
| Colours: | 3 colour temperatures |
| Light Source: | COB LED |
| Colour Temperature: | 3000K, 4000K & 5000K |
| CRI: | ≥90 |
| Number of LED Per Metre: | 640 |
| Wattage Per Metre: | 5W |
| Input Voltage: | 24V DC |
| Beam angle: | 180° |
| Wiring: | Parallel |
| IP Rating: | IP67** |
| Cutting Increments/Sections: | 25mm |
| Requires: | 24V DC Constant Voltage LED Driver |
| Dimmable: | Yes** |
| IES files: | Yes |
| Continuous Run: | 10m Max |

* With the use of Domus drivers

* All LED strip must be installed on an aluminium heat sink, failure to do so WILL VOID WARRANTY.

** Fully dimmable with suitable dimmers.



Plex COB 10 IP67



- True Dotless Technology
- Reduced Welded Joints

Specification:

| | |
|------------------------------|------------------------------------|
| Colours: | 3 colour temperatures |
| Light Source: | COB LED |
| Colour Temperature: | 3000K, 4000K & 5000K |
| CRI: | ≥90 |
| Number of LED Per Metre: | 640 |
| Wattage Per Metre: | 10W |
| Input Voltage: | 24V DC |
| Beam angle: | 180° |
| Wiring: | Parallel |
| IP Rating: | IP67** |
| Cutting Increments/Sections: | 25mm |
| Requires: | 24V DC Constant Voltage LED Driver |
| Dimmable: | Yes** |
| IES files: | Yes |
| Continuous Run: | 5m Max |

* With the use of Domus drivers

* All LED strip must be installed on an aluminium heat sink, failure to do so WILL VOID WARRANTY.

** Fully dimmable with suitable dimmers.



| Item No. | Variants | | | CCT | Lumen Output | Colour Simulation |
|-----------------|----------|-------|-------|-------|--------------|-------------------|
| | Per Mt | 20M | 50M | | | |
| PLEX-COB-5-IP67 | 24042 | 24056 | 24070 | 3000K | 380lm/m | Warm White |
| | 24043 | 24057 | 24071 | 4000K | 425lm/m | Neutral White |
| | 24044 | 24058 | 24072 | 5000K | 425lm/m | White |

| Item No. | Variants | | | CCT | Lumen Output | Colour Simulation |
|------------------|----------|-------|-------|-------|--------------|-------------------|
| | Per Mt | 20M | 50M | | | |
| PLEX-COB-10-IP67 | 24045 | 24059 | 24073 | 3000K | 760lm/m | Warm White |
| | 24046 | 24060 | 24074 | 4000K | 850lm/m | Neutral White |
| | 24047 | 24061 | 24075 | 5000K | 850lm/m | White |

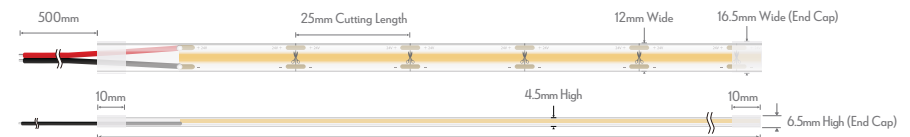
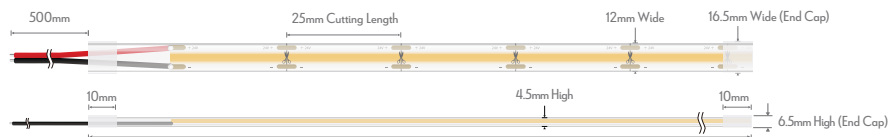

Interior

Interior

Plex COB 15 IP67



- True Dotless Technology
- Reduced Welded Joints

Specification:

| | |
|------------------------------|------------------------------------|
| Colours: | 3 colour temperatures |
| Light Source: | COB LED |
| Colour Temperature: | 3000K, 4000K & 5000K |
| CRI: | ≥90 |
| Number of LED Per Metre: | 640 |
| Wattage Per Metre: | 15W |
| Input Voltage: | 24V DC |
| Beam angle: | 180° |
| Wiring: | Parallel |
| IP Rating: | IP67** |
| Cutting Increments/Sections: | 25mm |
| Requires: | 24V DC Constant Voltage LED Driver |
| Dimmable: | Yes** |
| IES files: | Yes |
| Continuous Run: | 5m Max |

* With the use of Domus drivers
 * All LED strip must be installed on an aluminium heat sink, failure to do so WILL VOID WARRANTY.
 ** Fully dimmable with suitable dimmers.



Plex COB 20 IP67



- True Dotless Technology
- Reduced Welded Joints

Specification:

| | |
|------------------------------|------------------------------------|
| Colours: | 3 colour temperatures |
| Light Source: | COB LED |
| Colour Temperature: | 3000K, 4000K & 5000K |
| CRI: | ≥90 |
| Number of LED Per Metre: | 640 |
| Wattage Per Metre: | 20W |
| Input Voltage: | 24V DC |
| Beam angle: | 180° |
| Wiring: | Parallel |
| IP Rating: | IP67** |
| Cutting Increments/Sections: | 25mm |
| Requires: | 24V DC Constant Voltage LED Driver |
| Dimmable: | Yes** |
| IES files: | Yes |
| Continuous Run: | 3m Max |

* With the use of Domus drivers
 * All LED strip must be installed on an aluminium heat sink, failure to do so WILL VOID WARRANTY.
 ** Fully dimmable with suitable dimmers.

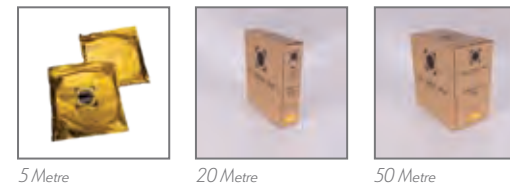

| Item No. | Variants | | | CCT | Lumen Output | Colour Simulation |
|------------------|----------|-------|-------|-------|--------------|-------------------|
| | Per Mt | 20M | 50M | | | |
| PLEX-COB-15-IP67 | 24048 | 24062 | 24076 | 3000K | 1140lm/m | Warm White |
| | 24049 | 24063 | 24077 | 4000K | 1275lm/m | Neutral White |
| | 24050 | 24064 | 24078 | 5000K | 1275lm/m | White |

| Item No. | Variants | | | CCT | Lumen Output | Colour Simulation |
|------------------|----------|-------|-------|-------|--------------|-------------------|
| | Per Mt | 20M | 50M | | | |
| PLEX-COB-20-IP67 | 24051 | 24065 | 24079 | 3000K | 1520lm/m | Warm White |
| | 24052 | 24066 | 24080 | 4000K | 1700lm/m | Neutral White |
| | 24053 | 24067 | 24081 | 5000K | 1700lm/m | White |

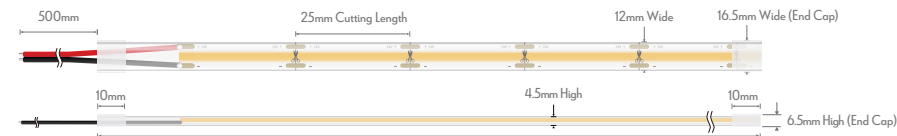
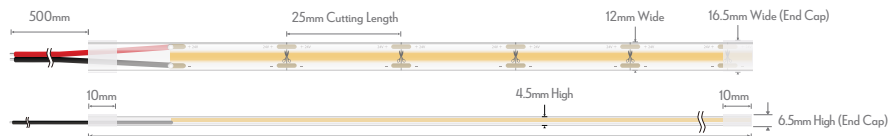

Vivid Red

Vivid Blue

Vivid Green

Vivid Yellow



Plex Vivid Series

Single Vivid Colour LED Strip

Specification:

| | |
|------------------------------|------------------------------------|
| Colours: | Red, Blue, Green & Yellow |
| Light Source: | COB LED |
| Number of LED Per Metre: | 640 |
| Wattage Per Metre: | 15W |
| Input Voltage: | 24V DC |
| Beam angle: | 180° |
| Wiring: | Parallel |
| IP Rating: | IP54 |
| Cutting Increments/Sections: | 25mm |
| Requires: | 24V DC Constant Voltage LED Driver |
| Dimmable: | Yes** |
| IES files: | Yes |
| Continuous Run: | 5m Max |

* With the use of Domus drivers

* All LED strip must be installed on an aluminium heat sink, failure to do so WILL VOID WARRANTY.

** For dimming options please refer to the controller section for further details.

| Strip | Variants | Colour | Lumen Output |
|------------|----------|--------|--------------|
| PLEX-VIVID | 24130 | Red | 105lm/m |
| | 24131 | Blue | 270lm/m |
| | 24132 | Green | 1650lm/m |
| | 24133 | Yellow | 1200lm/m |

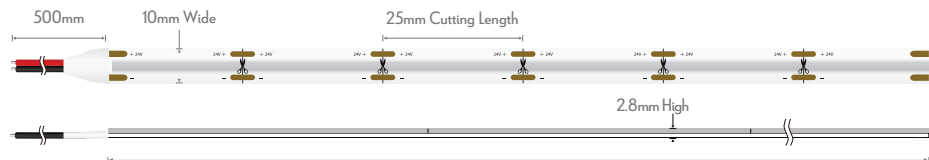

Vivid Red

Vivid Blue

Vivid Green

Vivid Yellow



Plex Vivid IP67 Series

Single Vivid Colour LED Strip

Specification:

| | |
|------------------------------|------------------------------------|
| Colours: | Red, Blue, Green & Yellow |
| Light Source: | COB LED |
| Number of LED Per Metre: | 640 |
| Wattage Per Metre: | 15W |
| Input Voltage: | 24V DC |
| Beam angle: | 180° |
| Wiring: | Parallel |
| IP Rating: | IP67 |
| Cutting Increments/Sections: | 25mm |
| Requires: | 24V DC Constant Voltage LED Driver |
| Dimmable: | Yes** |
| IES files: | Yes |
| Continuous Run: | 5m Max |

* With the use of Domus drivers

* All LED strip must be installed on an aluminium heat sink, failure to do so WILL VOID WARRANTY.

** For dimming options please refer to the controller section for further details.

| Strip | Variants | Colour | Lumen Output |
|-----------------|----------|--------|--------------|
| PLEX-VIVID-IP67 | 24140 | Red | 89lm/m |
| | 24141 | Blue | 230lm/m |
| | 24142 | Green | 1400lm/m |
| | 24143 | Yellow | 1020lm/m |

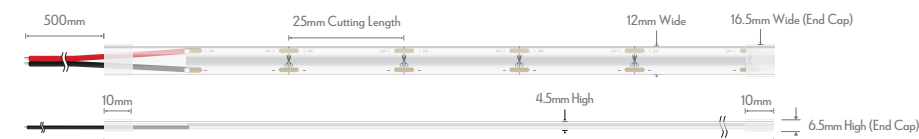

Plex RGBTW Series



Specification:

| | |
|------------------------------|------------------------------------|
| Colours: | RGB + Tuneable White |
| Light Source: | COB LED |
| CRI: | ≥90 |
| Number of LED Per Metre: | 840 |
| Wattage Per Metre: | 21W |
| Input Voltage: | 24V DC |
| Beam angle: | 180° |
| Wiring: | Parallel |
| IP Rating: | IP54 |
| Cutting Increments/Sections: | 35.7mm |
| Requires: | 24V DC Constant Voltage LED Driver |
| Dimmable: | Yes** |
| IES files: | Yes |
| Continuous Run: | 5m Max |

* All LED strip must be installed on an aluminium heat sink, failure to do so WILL VOID WARRANTY.

** For dimming options please refer to the controller section for further details.

| Strip | Variants | CCT | Lumen Output | | | |
|------------|----------|-------|--------------|-------|------|---------------------|
| | | | Red | Green | Blue | Warm White to White |
| PLEX-RGBTW | 24151 | RGBTW | 130lm | 310lm | 65lm | 335lm - 380lm |

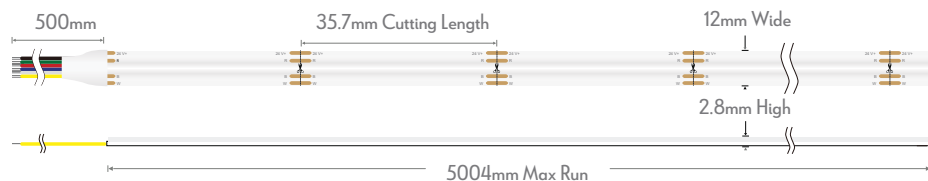

Plex RGBTW IP67 Series



Specification:

| | |
|------------------------------|------------------------------------|
| Colours: | RGB + Tuneable White |
| Light Source: | COB LED |
| CRI: | ≥90 |
| Number of LED Per Metre: | 840 |
| Wattage Per Metre: | 21W |
| Input Voltage: | 24V DC |
| Beam angle: | 180° |
| Wiring: | Parallel |
| IP Rating: | IP67 |
| Cutting Increments/Sections: | 35.7mm |
| Requires: | 24V DC Constant Voltage LED Driver |
| Dimmable: | Yes** |
| IES files: | Yes |
| Continuous Run: | 5m Max |

* All LED strip must be installed on an aluminium heat sink, failure to do so WILL VOID WARRANTY.

** For dimming options please refer to the controller section for further details.

| Strip | Variants | CCT | Lumen Output | | | |
|-----------------|----------|-------|--------------|-------|------|---------------------|
| | | | Red | Green | Blue | Warm White to White |
| PLEX-RGBTW-IP67 | 24152 | RGBTW | 110lm | 260lm | 55lm | 285lm - 325lm |

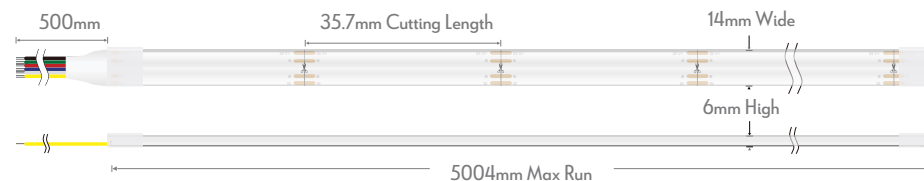

PLEX-RGB

PLEX-RGB-IP67

Plex RGB Series



| | |
|------------------------------|------------------------------------|
| Specification: | |
| Colours: | RGB |
| Light Source: | COB LED |
| Number of LED Per Metre: | 840 |
| Wattage Per Metre: | 14W |
| Input Voltage: | 24V DC |
| Beam angle: | 180° |
| Wiring: | Parallel |
| IP Rating: | IP54 |
| Cutting Increments/Sections: | 25mm |
| Requires: | 24V DC Constant Voltage LED Driver |
| Dimmable: | Yes** |
| IES files: | Yes |
| Continuous Run: | 5m Max |

* All LED strip must be installed on an aluminium heat sink, failure to do so WILL VOID WARRANTY.

** For dimming options please refer to the controller section for further details.

Plex RGB IP67 Series



| | |
|------------------------------|------------------------------------|
| Specification: | |
| Colours: | RGB |
| Light Source: | COB LED |
| Number of LED Per Metre: | 840 |
| Wattage Per Metre: | 14W |
| Input Voltage: | 24V DC |
| Beam angle: | 180° |
| Wiring: | Parallel |
| IP Rating: | IP67 |
| Cutting Increments/Sections: | 25mm |
| Requires: | 24V DC Constant Voltage LED Driver |
| Dimmable: | Yes** |
| IES files: | Yes |
| Continuous Run: | 5m Max |

* All LED strip must be installed on an aluminium heat sink, failure to do so WILL VOID WARRANTY.

** For dimming options please refer to the controller section for further details.

| Strip | Variants | CCT | Lumen Output | | |
|----------|----------|-----|--------------|-------|------|
| | | | Red | Green | Blue |
| PLEX-RGB | 24156 | RGB | 120lm | 400lm | 55lm |
| | | | | | |

| Strip | Variants | CCT | Lumen Output | | |
|---------------|----------|-----|--------------|-------|------|
| | | | Red | Green | Blue |
| PLEX-RGB-IP67 | 24158 | RGB | 102lm | 340lm | 47lm |
| | | | | | |

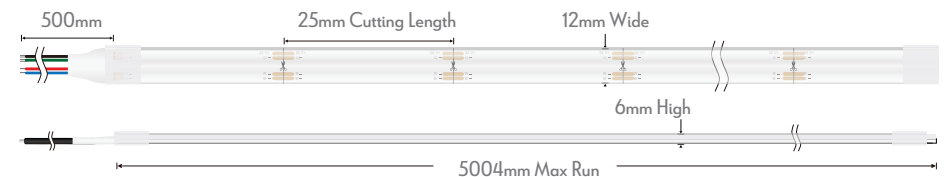
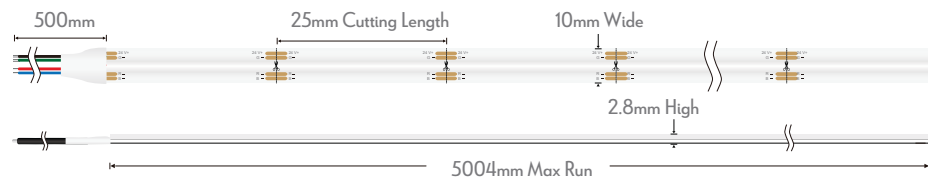



PLEX-COB-TW

Plex COB TW Series



| | |
|------------------------------|------------------------------------|
| Specification: | |
| Light Source: | COB LED |
| Colour Temperature: | 2700K - 6500K (Tuneable) |
| CRI: | ≥90 |
| Number of LED Per Metre: | 840 |
| Wattage Per Metre: | 20W |
| Input Voltage: | 24V DC |
| Beam angle: | 180° |
| Wiring: | Parallel |
| IP Rating: | IP54 |
| Cutting Increments/Sections: | 50mm |
| Requires: | 24V DC Constant Voltage LED Driver |
| Dimmable: | Yes** |
| IES files: | Yes |
| Continuous Run: | 5m Max |

* All LED strip must be installed on an aluminium heat sink, failure to do so WILL VOID WARRANTY.

** For dimming options please refer to the controller section for further details.

| Strip | Variants | CCT | Lumen Output |
|-------------|----------|--------------------------|--------------|
| PLEX-COB-TW | 24171 | 2700K - 6500K (Tuneable) | 800-1700lm/m |

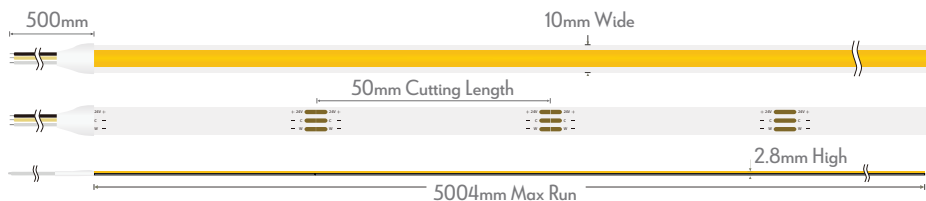

PLEX-COB-TW-IP67

Plex COB TW IP67 Series



| | |
|------------------------------|------------------------------------|
| Specification: | |
| Light Source: | COB LED |
| Colour Temperature: | 2700K - 6500K (Tuneable) |
| CRI: | ≥90 |
| Number of LED Per Metre: | 840 |
| Wattage Per Metre: | 20W |
| Input Voltage: | 24V DC |
| Beam angle: | 180° |
| Wiring: | Parallel |
| IP Rating: | IP67 |
| Cutting Increments/Sections: | 50mm |
| Requires: | 24V DC Constant Voltage LED Driver |
| Dimmable: | Yes** |
| IES files: | Yes |
| Continuous Run: | 5m Max |

* All LED strip must be installed on an aluminium heat sink, failure to do so WILL VOID WARRANTY.

** For dimming options please refer to the controller section for further details.

| Strip | Variants | CCT | Lumen Output |
|------------------|----------|--------------------------|--------------|
| PLEX-COB-TW-IP67 | 24173 | 2700K - 6500K (Tuneable) | 680-1450lm/m |

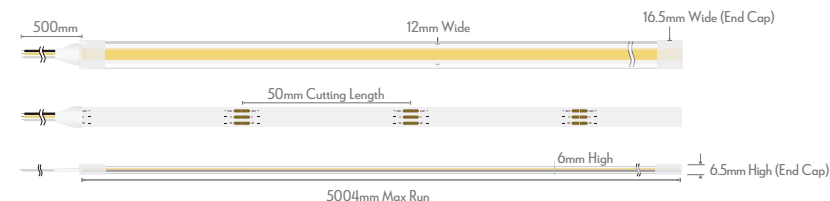

Plex MICRO Series



Specification:

| | |
|------------------------------|------------------------------------|
| Light Source: | COB LED |
| Colour Temperature: | 3000K, 4000K & 5000K |
| CRI: | ≥90 |
| Number of LED Per Metre: | 480 |
| Wattage Per Metre: | 8W |
| Input Voltage: | 24V |
| Beam angle: | 180° |
| Wiring: | Parallel |
| IP Rating: | IP54 |
| Cutting Increments/Sections: | 50mm |
| Requires: | 24V DC Constant Voltage LED Driver |
| Dimmable: | Yes** |
| IES files: | Yes |
| Continuous Run: | 5m Max |

* With the use of Domus drivers

* All LED strip must be installed on an aluminium heat sink, failure to do so WILL VOID WARRANTY.

** Fully dimmable with suitable dimmers.

| Strip | Variants | CCT | Lumen Output |
|------------|----------|-------|--------------|
| PLEX-MICRO | 24162 | 3000K | 640-720lm/m |
| | 24163 | 4000K | |
| | 24164 | 5000K | |

Compatible Profile

| Micro SM | Micro REC |
|----------|-----------|
| • | • |

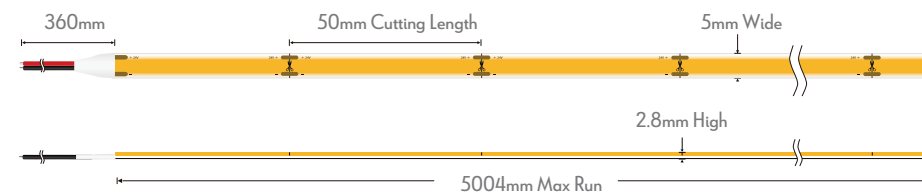

Plex COB Accessories



PLEX-COB-FCCON - 23992

PLEX-COB 126mm Flexible Strip To Strip Connector (5 Pack)

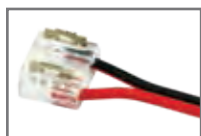

PLEX-COB-ICCON - 23991

PLEX-COB 500mm Live Cable Connector (5 Pack)



PLEX-COB-ICON - 23993

PLEX-COB L-Shape Strip To Strip Connector (5 Pack)



PLEX-COB-SCON - 23990

PLEX-COB Straight Strip To Strip Connector (5 Pack)

| | ICCON | ICON | SCON | FCCON |
|----------|-------|-------|-------|-------|
| PLEX-COB | 23991 | 23993 | 23990 | 23992 |

Interior

Interior

Plex ULTRA Series (Designed for long run lengths)



| | |
|------------------------------|------------------------------------|
| Specification: | |
| Light Source: | COB LED |
| Colour Temperature: | 3000K, 4000K & 5000K |
| CRI: | ≥90 |
| Number of LED Per Metre: | 560 |
| Wattage Per Metre: | 10W |
| Input Voltage: | 24V DC |
| Beam angle: | 180° |
| Wiring: | Parallel |
| IP Rating: | IP54 |
| Cutting Increments/Sections: | 25mm |
| Requires: | 24V DC Constant Voltage LED Driver |
| Dimmable: | Yes** |
| IES files: | Yes |
| Continuous Run: | 13m Max |

* With the use of Domus drivers

* All LED strip must be installed on an aluminium heat sink, failure to do so WILL VOID WARRANTY.

** Fully dimmable with suitable dimmers.

| Strip | Variants | CCT | Lumen Output |
|------------|----------|-------|--------------|
| PLEX-ULTRA | 24177 | 3000K | 770-810lm/m |
| | 24178 | 4000K | |
| | 24179 | 5000K | |

Plex ULTRA IP67 Series (Designed for long run lengths)



| | |
|------------------------------|------------------------------------|
| Specification: | |
| Light Source: | COB LED |
| Colour Temperature: | 3000K, 4000K & 5000K |
| CRI: | ≥90 |
| Number of LED Per Metre: | 560 |
| Wattage Per Metre: | 10W |
| Input Voltage: | 24V DC |
| Beam angle: | 180° |
| Wiring: | Parallel |
| IP Rating: | IP67 |
| Cutting Increments/Sections: | 25mm |
| Requires: | 24V DC Constant Voltage LED Driver |
| Dimmable: | Yes** |
| IES files: | Yes |
| Continuous Run: | 13m Max |

* With the use of Domus drivers

* All LED strip must be installed on an aluminium heat sink, failure to do so WILL VOID WARRANTY.

** Fully dimmable with suitable dimmers.

| Strip | Variants | CCT | Lumen Output |
|-----------------|----------|-------|--------------|
| PLEX-ULTRA-IP67 | 24184 | 3000K | 650-688lm/m |
| | 24185 | 4000K | |
| | 24186 | 5000K | |

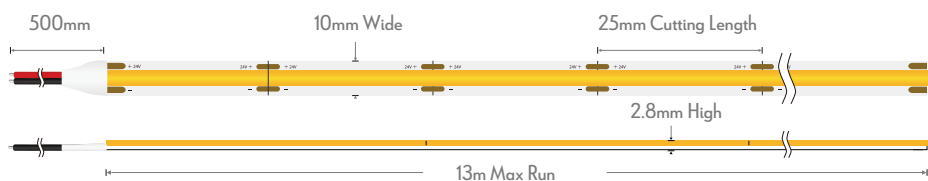



Plex SMD-5 IP66 Series

(Designed for extra long run lengths)



| | |
|------------------------------|------------------------------------|
| Specification: | |
| Light Source: | SMD LED |
| Colour Temperature: | 3000K, 4000K & 5000K |
| CRI: | ≥90 |
| Number of LED Per Metre: | 70 |
| Wattage Per Metre: | 5W |
| Input Voltage: | 24V DC |
| Beam angle: | 120° |
| Wiring: | Parallel |
| IP Rating: | IP66 |
| Cutting Increments/Sections: | 100mm |
| Requires: | 24V DC Constant Voltage LED Driver |
| Dimmable: | Yes** |
| IES files: | Yes |
| Continuous Run: | 40m Max |

* With the use of Domus drivers

* All LED strip must be installed on an aluminium heat sink, failure to do so WILL VOID WARRANTY.

** Fully dimmable with suitable dimmers.

| Strip | Variants | CCT | Lumen Output |
|-----------------|----------|-------|--------------|
| PLEX-SMD-5-IP66 | 24207 | 3000K | 500-550lm/m |
| | 24208 | 4000K | |
| | 24209 | 5000K | |

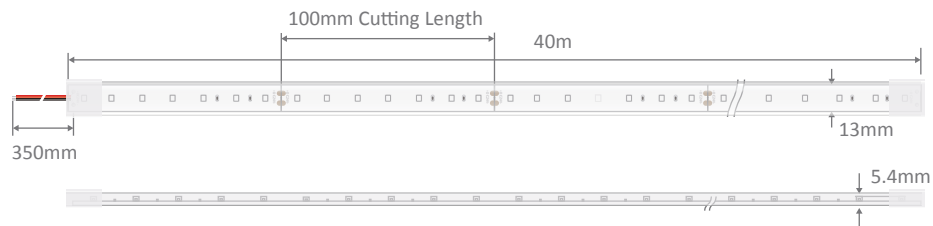

Royal Motor Yacht Club





PLEX-SMD-9



PLEX-SMD-9-IP67

Plex SMD-9 Series (Designed for long run lengths)



| | |
|------------------------------|------------------------------------|
| Specification: | |
| Light Source: | SMD LED |
| Colour Temperature: | 3000K, 4000K & 5000K |
| CRI: | ≥90 |
| Number of LED Per Metre: | 120 |
| Wattage Per Metre: | 9W |
| Input Voltage: | 24V DC |
| Beam angle: | 120° |
| Wiring: | Parallel |
| IP Rating: | IP54 |
| Cutting Increments/Sections: | 25mm |
| Requires: | 24V DC Constant Voltage LED Driver |
| Dimmable: | Yes** |
| IES files: | Yes |
| Continuous Run: | 20m Max |

* With the use of Domus drivers

* All LED strip must be installed on an aluminium heat sink, failure to do so WILL VOID WARRANTY.

** Fully dimmable with suitable dimmers.

| Strip | Variants | CCT | Lumen Output |
|------------|----------|-------|--------------|
| PLEX-SMD-9 | 24192 | 3000K | 765-855lm/m |
| | 24193 | 4000K | |
| | 24194 | 5000K | |

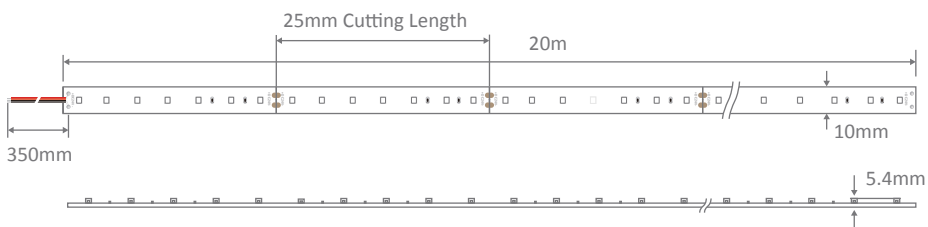

Plex SMD-9 IP67 Series (Designed for long run lengths)



| | |
|------------------------------|------------------------------------|
| Specification: | |
| Light Source: | SMD LED |
| Colour Temperature: | 3000K, 4000K & 5000K |
| CRI: | ≥90 |
| Number of LED Per Metre: | 120 |
| Wattage Per Metre: | 9W |
| Input Voltage: | 24V DC |
| Beam angle: | 120° |
| Wiring: | Parallel |
| IP Rating: | IP67 |
| Cutting Increments/Sections: | 25mm |
| Requires: | 24V DC Constant Voltage LED Driver |
| Dimmable: | Yes** |
| IES files: | Yes |
| Continuous Run: | 20m Max |

* With the use of Domus drivers

* All LED strip must be installed on an aluminium heat sink, failure to do so WILL VOID WARRANTY.

** Fully dimmable with suitable dimmers.

| Strip | Variants | CCT | Lumen Output |
|-----------------|----------|-------|--------------|
| PLEX-SMD-9-IP67 | 24199 | 3000K | 650-725lm/m |
| | 24200 | 4000K | |
| | 24201 | 5000K | |

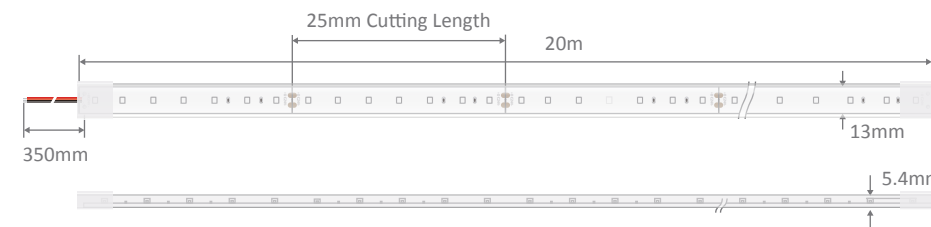



Pleo 14.4

- LED Neon Flex

Specification:

| | |
|------------------------------|------------------------------------|
| Colours: | 3 colour temperatures |
| Light Source: | 2835 SMD LED |
| Colour Temperature: | 3000K, 4000K & 5000K |
| CRI: | 90 |
| Number of LED Per Metre: | 140 |
| Wattage Per Metre: | 14.4W |
| Input Voltage: | 24V DC |
| Beam angle: | 120° |
| Wiring: | Parallel |
| IP Rating: | IP66 |
| Cutting Increments/Sections: | 50mm |
| Requires: | 24V DC Constant Voltage LED Driver |
| Dimmable: | Yes* |
| IES files: | Yes** |
| Continuous Run: | 5m Max |

* For dimming options please refer to the controller section for further details.

** Available upon request.

| Strip | Variants | CCT | Lumen Output | Colour Simulation |
|-----------|----------|-------|--------------|-------------------|
| PLEO-14.4 | 20353 | 3000K | 118lm/m | Warm White |
| | 20354 | 4000K | 1253lm/m | Neutral White |
| | 20355 | 5000K | 1253lm/m | White |

2700K available upon request

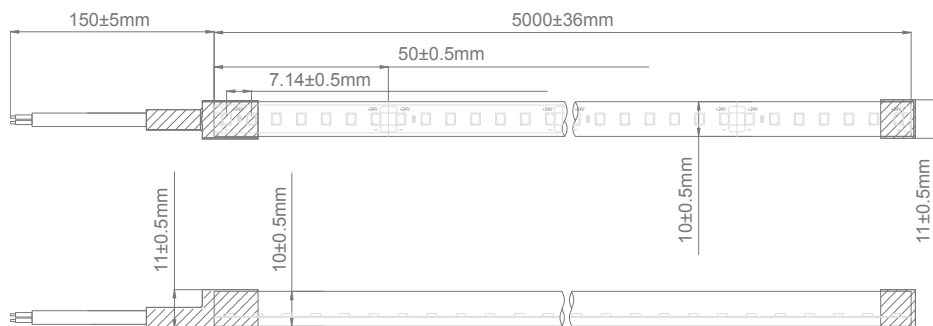

Pleo 14.4S

- LED Neon Flex
- Side Emitting
- Ideal for curved features

Specification:

| | |
|------------------------------|------------------------------------|
| Colours: | 3 colour temperatures |
| Light Source: | 2835 SMD LED |
| Colour Temperature: | 3000K, 4000K & 5000K |
| CRI: | 90 |
| Number of LED Per Metre: | 140 |
| Wattage Per Metre: | 14.4W |
| Input Voltage: | 24V DC |
| Beam angle: | 120° |
| Wiring: | Parallel |
| IP Rating: | IP66 |
| Cutting Increments/Sections: | 50mm |
| Requires: | 24V DC Constant Voltage LED Driver |
| Dimmable: | Yes* |
| IES files: | Yes** |
| Continuous Run: | 5m Max |

* For dimming options please refer to the controller section for further details.

** Available upon request.

| Strip | Variants | CCT | Lumen Output | Colour Simulation |
|-------------|----------|-------|--------------|-------------------|
| PLEO-14.4-S | 20357 | 3000K | 320lm/m | Warm White |
| | 20358 | 4000K | 346lm/m | Neutral White |
| | 20359 | 5000K | 370lm/m | White |

2700K available upon request



CHAM-BT-RF-5C

The CHAM-BT-RF-5C is a 5-channel controller that can be used with a remote, touch panel wall control, or Bluetooth. Intended for use with constant voltage 12-24V DC lighting products the CHAM-BT-RF-5C offers various ways to control LED strip just by pairing it with a remote control, or a touch wall panel, or by using Bluetooth and controlling with a smart phone with the app. The CHAM-BT-RF-5C also works with GOOGLE and Alexa. Featuring 5 channels allowing control over single colour, RGB or RGBW lighting products.

| | |
|------------------------------|---|
| Specification: | |
| Type of controller: | 5ch 4 in 1 universal RF+ Bluetooth controller |
| Method of control: | PWM |
| Method of dimming: | PWM (Pulse Width Modulation) |
| Housing colour: | Black plastic colour housing |
| Housing size (mm): | (L) 145mm x (W) 46.5mm x (H) 16mm |
| Input voltage (VDC): | 12-24V DC |
| Output voltage (VDC): | 12-24V DC |
| Output current (A): | 5x4A |
| Output wattage (W): | 12V DC - 48W per channel (x5). 24V DC - 96W per channel (x5). |
| Expandable signal: | Yes* |
| Requires: | Constant Voltage 12-24V DC LED driver** |

* Multiple 5CH data repeaters can be used in a single circuit.

** Constant Voltage LED driver required (not included) depending on requirements of light source (12V or 24V DC).

| Item No. | Variants | Details |
|---------------|----------|----------------|
| CHAM-BT-RF-5C | 20141 | 5CH Controller |

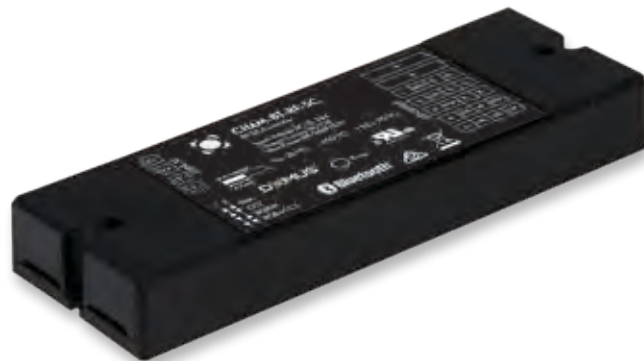

CHAM-BT-RF-5C



CHAM-REM-3C

The CHAM-REM-3C is an RF + Bluetooth RGBW remote control that is to be used with the CHAM-BT-RF-5C receiver. This remote allows you to dim the LED strip, change the colour and speed up or slow down the speed of the changing colour mode. It also allows you to save specific scenes that you use on a regular basis. The CHAM-REM-3C also has a magnet on the back which allows for ease of use with the mounting bracket.

Specification:

| | |
|-------------------------|---------------------------------------|
| Type of controller: | RGBW Remote control |
| Protocol: | RF + Bluetooth |
| Dimming range: | 0.1% - 100% |
| Remote colour: | Black |
| Remote size (mm): | (L) 136.3mm x (W) 38.9mm x (D) 10.7mm |
| Transmission frequency: | 2.4GHz |
| Transmission range: | 30m |
| Operation voltage: | 3VDC (CR2025) |

| Item No. | Variants | Details |
|-------------|----------|-------------|
| CHAM-REM-3C | 20142 | RGBW Remote |

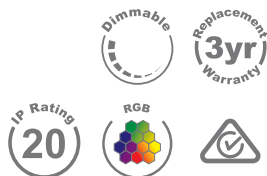

CHAM-REM-1C

The CHAM-REM-1C is an RF + Bluetooth Single colour remote control that is to be used with the CHAM-BT-RF-5C receiver. This remote allows you to dim the LED strip. It also allows you to save specific scenes that you use on a regular basis. The CHAM-REM-1C also has a magnet on the back which allows for ease of use with the mounting bracket.

Specification:

| | |
|-------------------------|--------------------------------------|
| Type of controller: | Single colour dimming remote control |
| Protocol: | RF + Bluetooth |
| Dimming range: | 0.1% - 100% |
| Remote colour: | Black |
| Remote size (mm): | (L) 150mm x (W) 38.6mm x (D) 12mm |
| Transmission frequency: | 2.4GHz |
| Transmission range: | 30m |
| Operation voltage: | 3VDC (CR2025) |

| Item No. | Variants | Details |
|-------------|----------|----------------------|
| CHAM-REM-1C | 20143 | Single Colour Remote |





CHAM-TOUCH-3C

The CHAM-TOUCH-3C is an RF + Bluetooth RGBW AC wall control that is to be used with the CHAM-BT-RF-5C receiver. The CHAM-TOUCH-3C wall control allows you to dim the LED strip, change the colour, and speed up or slow down the speed of the changing colour mode. It also allows you to save specific scenes that you use on a regular basis.

| Specification: | |
|-------------------------|-----------------------------------|
| Type of controller: | RGBW touch wall control |
| Output signal: | RF + Bluetooth |
| Dimming range: | 0.1% - 100% |
| Colour: | White (Glass) |
| Dimensions (mm): | (L) 120mm x (W) 75mm x (D) 29.1mm |
| Cut out (mm): | (L) 70mm x (W) 44mm x (D) 20mm |
| Transmission frequency: | 2.4GHz |
| Operating temperature: | 0-40°C |
| Power consumption: | < 15mA |
| Operation voltage: | 240V |



| Item No. | Variants | Details |
|---------------|----------|---------------------|
| CHAM-TOUCH-3C | 20144 | 3CH Wall Controller |

- Dimmable
- Replacement Warranty (3yr)
- Voltage (240V)
- IP Rating (20)
- Channels (3)
- RGB



CHAM-TOUCH-1C

The CHAM-TOUCH-1C is an RF + Bluetooth Single colour AC wall control that is to be used with the CHAM-BT-RF-5C receiver. The CHAM-TOUCH-1C wall control allows you to dim the LED strip. It also allows you to save specific scenes that you use on a regular basis.

| Specification: | |
|-------------------------|-----------------------------------|
| Type of controller: | Single colour touch wall control |
| Output signal: | RF + Bluetooth |
| Dimming range: | 0.1% - 100% |
| Colour: | White (Glass) |
| Dimensions (mm): | (L) 120mm x (W) 75mm x (D) 29.1mm |
| Cut out (mm): | (L) 70mm x (W) 44mm x (D) 20mm |
| Transmission frequency: | 2.4GHz |
| Operating temperature: | 0-40°C |
| Power consumption: | < 15mA |
| Operation voltage: | 240V |



| Item No. | Variants | Details |
|---------------|----------|---------------------|
| CHAM-TOUCH-1C | 20145 | 1CH Wall Controller |

- Dimmable
- Replacement Warranty (3yr)
- Voltage (240V)
- IP Rating (20)
- Channels (1)



CHAM-DR-4C

The CHAM-DR-4C is a 4 channel signal strength data repeater. The CHAM-DR-4C offers the ability to expand the signal strength generated by the master controller. In the situation where the load limit is exceeded or more than the limit set by the Master controller the CHAM-DR-4C is able to duplicate the signal without signal loss. This means whether using RGB, RGBW or single colour when colour changing or dimming the selected user colour will always remain the same. Particularly useful where a single master controller is used to control large areas or multiple zones.

| | |
|-----------------------|---|
| Specification: | |
| Type of controller: | 4ch Data Repeater |
| Method of control: | PWM* |
| Method of dimming: | PWM (Pulse Width Modulation) |
| Housing colour: | Black plastic colour housing |
| Housing size (mm): | (L) 168mm x (W) 58mm x (H) 28mm |
| Input voltage (VDC): | 12-24V DC |
| Output voltage (VDC): | 12-24V DC |
| Output current (A): | 4x8A |
| Output wattage (W): | 12V DC - 96W per channel (x4). 24V DC - 192W per channel (x4). |
| Expandable signal: | Yes** |
| Requires: | Constant Voltage 12-24V DC LED driver*** |

* Accepts signal generated from a Master controller. The signal output from the Master controller must be a PWM type output.

** Multiple 4CH data repeaters can be used in a single circuit.

*** Constant Voltage LED driver required (not included) depending on requirements of light source (12V or 24V DC).

| Item No. | Variants | Details |
|------------|----------|-------------------|
| CHAM-DR-4C | 20114 | 4CH Data Repeater |



CHAM-DR-1C

The CHAM-DR-1C is a 1 channel high power data repeater. The CHAM-DR-1C offers the ability to expand the signal strength generated by the master controller for dimming circuits. In situations where the load limit is exceeded or more than the limit set by the Master controller the CHAM-DR-1C is able to duplicate the signal without signal loss. This means whether dimming via RF, 0-10V, DALI or DMX you can be assured that the dimming signal will always be stable thus avoiding the appearance of dim light over larger areas. Particularly useful where a single master controller is used to control large areas or multiple zones.

| | |
|-----------------------|---|
| Specification: | |
| Type of controller: | 1ch High Power Data Repeater |
| Method of control: | PWM* |
| Method of dimming: | PWM (Pulse Width Modulation) |
| Housing colour: | Black metal colour housing |
| Housing size (mm): | (L) 150mm x (W) 54mm x (H) 31mm |
| Input voltage (VDC): | 12-24V DC |
| Output voltage (VDC): | 12-24V DC |
| Output current (A): | 1x24A |
| Output wattage (W): | 12V DC - 288W (x1) 24V DC - 576W (x1) |
| Expandable signal: | Yes** |
| Protection: | Yes, replaceable external 25A blade fuse*** |
| Requires: | Constant Voltage 12-24V DC LED driver*** |

* Accepts signal generated from a Master controller. The signal output from the Master controller must be a PWM type output.

** Multiple 1CH data repeaters can be used in a single circuit.

*** Standard replacement blade type fuse. Available from any electronics supplier.

**** Constant Voltage LED driver required (not included) depending on requirements of light source (12V or 24V DC).

| Item No. | Variants | Details |
|------------|----------|-------------------------|
| CHAM-DR-1C | 20134 | 1CH Power Data Repeater |



Interior

Interior

Chameleon

Chameleon



CHAM-DIM-DALI-4C

The CHAM-DIM-DALI-4C is an interface designed to suit DALI dim applications. Intended for use with Constant Voltage 12-24V DC lighting products the CHAM-DIM-DALI-4C offers seamless integration between automation systems. Accepts standard DALI signal generated from any automation system. Featuring 1-4CH of dimming, allowing control over single colour, RGB or RGBW LED lighting products. The CHAM-DIM-DALI-4C make integration a breeze with options for Auto addressing or manual addressing function.

| | |
|-----------------------|---|
| Specification: | |
| Type of controller: | 1-4ch Dimming Controller (selectable) |
| Method of control: | DALI signal* |
| Method of dimming: | PWM (Pulse Width Modulation) |
| Housing colour: | Black plastic colour housing |
| Housing size (mm): | (L) 169mm x (W) 58mm x (H) 28mm |
| Digital display: | Yes |
| Input voltage (VDC): | 12-24V DC |
| Output voltage (VDC): | 12-24V DC |
| Output current (A): | 4x8A |
| Output wattage (W): | 12V DC - 96W per channel (x4) 24V DC - 192W per channel (x4) |
| Expandable signal: | Yes** |
| Requires: | Constant Voltage 12-24V DC LED driver *** |

* Accepts signal generated from automation systems via a DALI gateway (Type 6 device).
 ** 4CH data repeater recommended for loads that exceed the CHAM-DIM-DALI-4C limits. CHAM-DR-4C (2014) not included.
 *** Constant Voltage LED driver required (not included) depending on requirements of light source (12V or 24V DC).

| Item No. | Variants | Details |
|------------------|----------|--------------------|
| CHAM-DIM-DALI-4C | 20149 | 4CH DALI Interface |



CHAM-DIM-DALI-1C

The CHAM-DIM-DALI-1C is an interface designed to suit DALI dim applications. Intended for use with Constant Voltage 12-24V DC lighting products the CHAM-DIM-DALI-1C offers seamless integration between automation systems. Accepts standard DALI signal generated from any automation system or simple dimming using the "Push Dim" function. Featuring 1CH of dimming, allowing control over single colour LED lighting products. The CHAM-DIM-DALI-1C make integration a breeze with options for Auto addressing or manual addressing function.

| | |
|-----------------------|---|
| Specification: | |
| Type of controller: | 1ch Dimmer |
| Method of control: | DALI or "Push Dim"* |
| Method of dimming: | PWM (Pulse Width Modulation) |
| Housing colour: | Black plastic colour housing |
| Housing size (mm): | (L) 169mm x (W) 58mm x (H) 28mm |
| Digital display: | Yes |
| Input voltage (VDC): | 12-24V DC |
| Output voltage (VDC): | 12-24V DC |
| Output current (A): | 1 x 8A |
| Output wattage (W): | 12V DC - 96W (x1) 24V DC - 192W (x1) |
| Expandable signal: | Yes** |
| Requires: | Constant Voltage 12-24V DC LED driver *** |

* Accepts signal generated from automation systems via a DALI gateway or via momentary Switch when "Push dim" mode is selected (Type 6 device).
 *** 1CH data repeater recommended for loads that exceed the CHAM-DIM-DALI-1C limits. CHAM-DR-1C (20134) not included.
 **** Constant Voltage LED driver required (not included) depending on requirements of light source (12V or 24V DC).

| Item No. | Variants | Details |
|------------------|----------|--------------------|
| CHAM-DIM-DALI-1C | 20132 | DALI 1CH Interface |



Interior

Interior

Chameleon

Chameleon



CHAM-DIM-DMX

The CHAM-DIM-DMX is an interface designed to decode DMX-512 signals. Designed for use with Constant Voltage 12-24V DC lighting products the CHAM-DIM-DMX offers seamless integration between automation systems and/or lighting desk consoles and luminaires. Accepts standard DMX-512 signal generated from any automation system or lighting control console. Featuring up to 4CH of dimming, allowing control over RGB, RGBW or single colour LED lighting products.

Specification:

| | |
|--------------------------|---|
| Type of interface: | RGBW 4ch Controller |
| Method of control: | DMX-512* |
| Method of dimming: | PWM (Pulse Width Modulation) |
| Housing colour: | Black plastic colour housing |
| Housing size (mm): | (L) 168mm x (W) 58mm x (H) 28mm |
| Digital display: | Yes |
| Input voltage (VDC): | 12-24V DC |
| Output voltage (VDC): | 12-24V DC |
| Output current (A): | 4 x 8A |
| Output wattage (W): | 12V DC - 96W per channel (x4) 24V DC - 192W per channel (x4) |
| Multi-channel operation: | Yes** |
| Expandable signal: | Yes*** |
| Requires: | Constant Voltage 12-24V DC LED driver **** |

* Accepts signal generated from automation systems via a DMX-512 gateway or lighting control console.
 ** 3-4CH selectable depending on use. RGB (3CH) or RGBW (4CH).
 *** 4CH data repeater recommended for loads that exceed the CHAM-DIM-DMX limits. CHAM-DR-4C (20114) not included.
 **** Constant Voltage LED driver required (not included) depending on requirements of light source (12V or 24V DC).

| Item No. | Variants | Details |
|--------------|----------|-----------------------|
| CHAM-DIM-DMX | 20129 | 4CH DMX-512 Interface |







CHAM-DIM-DMX



Maxi Series

Choose profile and choose from the available diffusers.

Colour Legend

| | |
|---|------------------|
|  | Heat Sink |
|  | Diffuser |
|  | Upwards Emitting |
|  | Honeycomb |

Maxi 40 Series

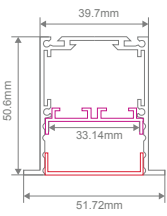

Surface Mounted

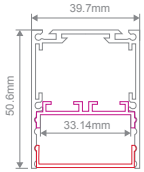

Recessed

Maxi 50 Series

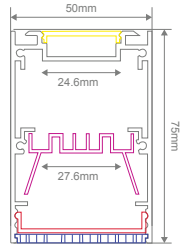

Surface Mounted

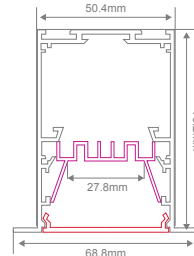

Recessed

Maxi 75 Series

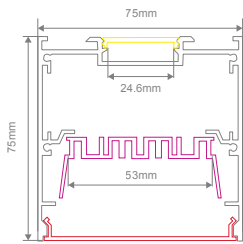

Surface Mounted

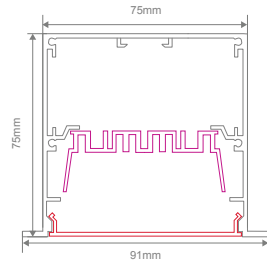

Recessed

Maxi Curve Series

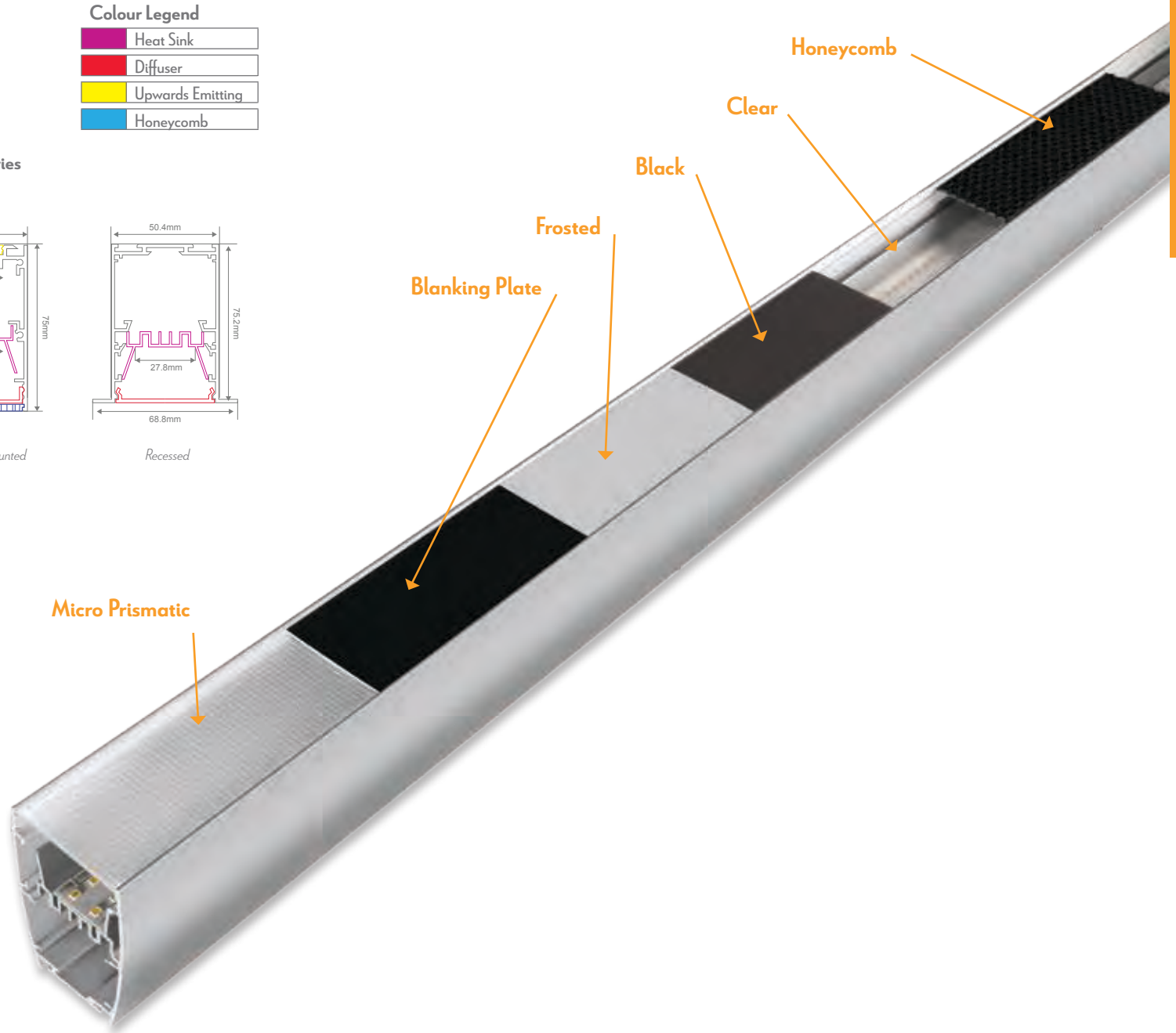
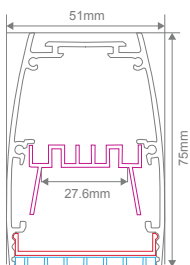

Interior

Interior



Maxi-40 Recessed Flat Series

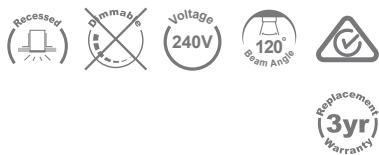

- Profile includes Driver and Osram LED Boards.
- Sold Per Metre
- Inbuilt LED Driver.
- Aluminium profile and diffuser
- Low and High Diffuser mounting options available upon request
- Made to order in Australia from local and imported components.
- DALI & DALI Tuneable white options available upon request.
- CRI90
- IP20 Indoor Use Only.
- Custom Lengths and Designs available upon request.

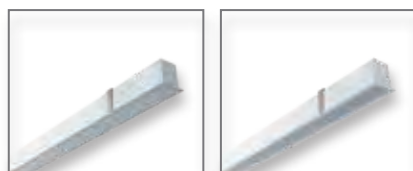

MAXI-40-REC-ALU

MAXI-40-REC-WHT

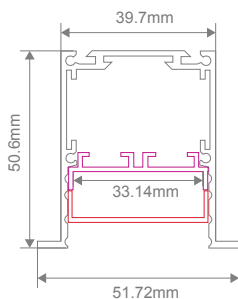

| Item No. | Variants | | | Wattage | Diffuser | CCT | Lumen Output |
|---------------|----------|-------|-------|---------|-----------|-------|--------------|
| | Blk | Wht | Alu | | | | |
| MAXI-40-RC-FD | 27805 | 27810 | 27800 | 22W | Prismatic | 3000K | 2645lm |
| | 27806 | 27811 | 27801 | | Frosted | | |
| | 27807 | 27812 | 27802 | | Black | | |
| | 27808 | 27813 | 27803 | | Clear | | |
| MAXI-40-RC-FD | 27820 | 27825 | 27815 | 48W | Prismatic | 4000K | 2788lm |
| | 27821 | 27826 | 27816 | | Frosted | | |
| | 27822 | 27827 | 27817 | | Black | | |
| | 27823 | 27828 | 27818 | | Clear | | |



Maxi-40 Surface Mount Flat Series

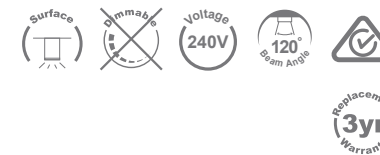

- Profile includes Driver and Osram LED Boards.
- Sold Per Metre
- Inbuilt LED Driver.
- Aluminium profile and diffuser
- Low and High Diffuser mounting options available upon request
- Made to order in Australia from local and imported components.
- DALI & DALI Tuneable white options available upon request.
- CRI90
- IP20 Indoor Use Only.
- Custom Lengths and Designs available upon request.

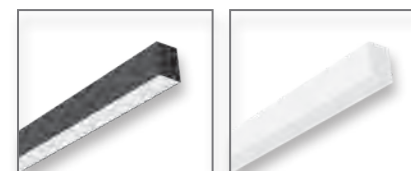
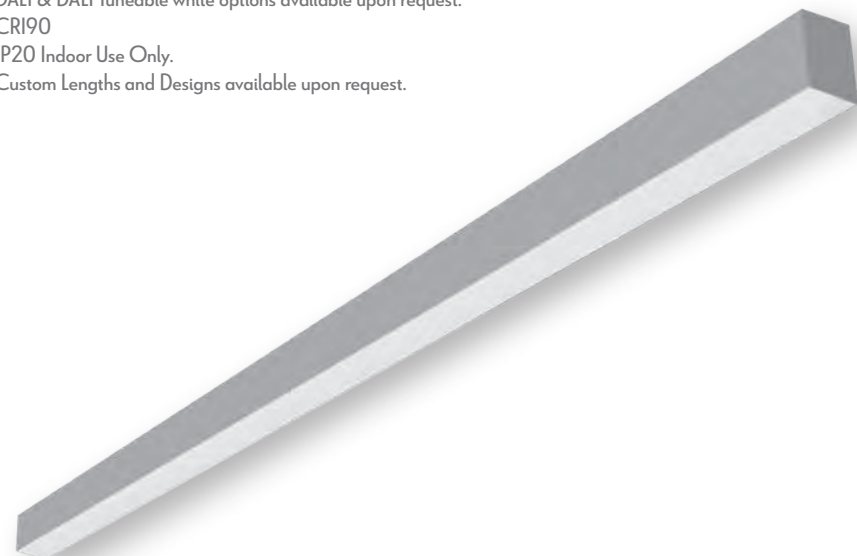

MAXI-40-SM-BLK

MAXI-40-SM-WHT

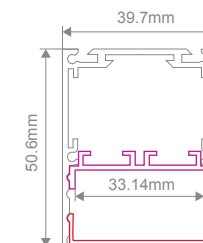

| Item No. | Variants | | | Wattage | Diffuser | CCT | Lumen Output |
|---------------|----------|-------|-------|---------|-----------|-------|--------------|
| | Blk | Wht | Alu | | | | |
| MAXI-40-SM-FD | 27535 | 27540 | 27530 | 22W | Prismatic | 3000K | 2645lm |
| | 27536 | 27541 | 27531 | | Frosted | | |
| | 27537 | 27542 | 27532 | | Black | | |
| | 27538 | 27543 | 27533 | | Clear | | |
| MAXI-40-SM-FD | 27550 | 27555 | 27545 | 22W | Prismatic | 4000K | 2788lm |
| | 27551 | 27556 | 27546 | | Frosted | | |
| | 27552 | 27557 | 24547 | | Black | | |
| | 27553 | 27558 | 27548 | | Clear | | |



Maxi-40 Pendant Flat Series



- Profile includes Driver and Osram LED Boards.
- Sold Per Metre
- Inbuilt LED Driver.
- Aluminium profile and diffuser
- Complete with 3m wire suspensions and 3m clear power cable.
- Low and High Diffuser mounting options available upon request.
- Made to order in Australia from local and imported components.
- DALI & DALI Tuneable white options available upon request.
- CRI90
- IP20 Indoor Use Only.
- Custom Lengths and Designs available upon request.

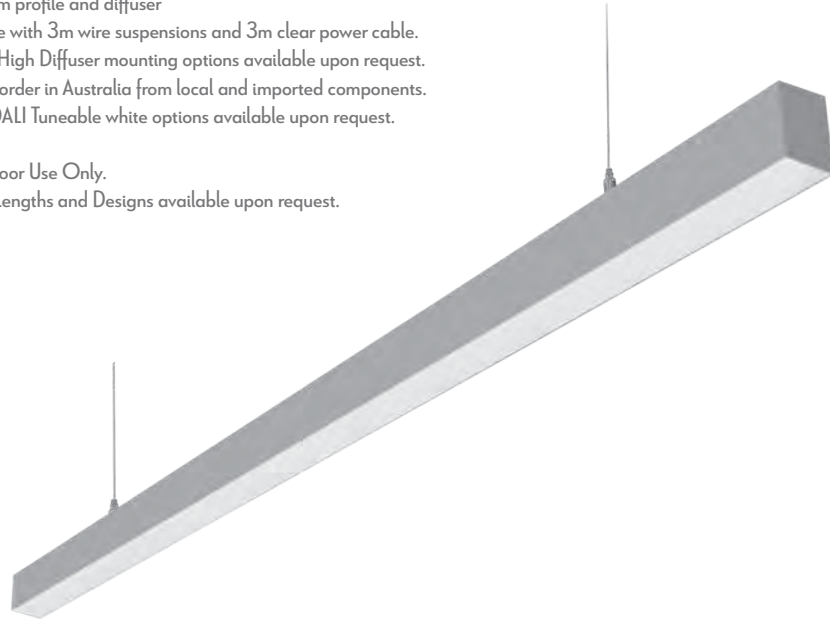

MAXI-40-DN-BLK MAXI-40-DN-WHT

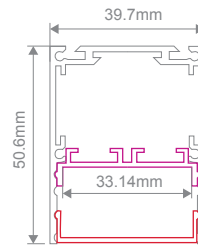

Maxi-40 Down Only Wall Bracket Flat Series

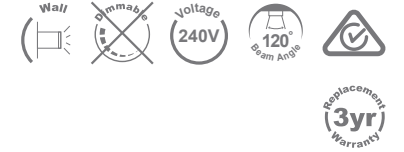

- Profile includes Driver and Osram LED Boards.
- Sold Per Metre
- Inbuilt LED Driver.
- Aluminium profile and diffuser
- Low and High Diffuser mounting options available upon request
- Made to order in Australia from local and imported components.
- DALI & DALI Tuneable white options available upon request.
- CRI90
- IP20 Indoor Use Only.
- Custom Lengths and Designs available upon request.

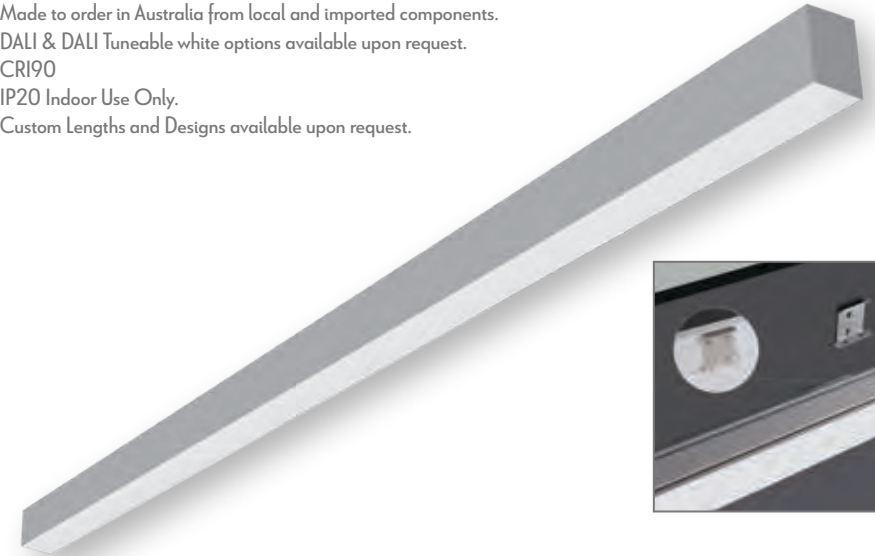

MAXI-40-WB-BLK MAXI-40-WB-WHT

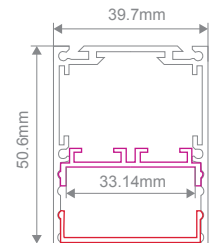

| Item No. | Variants | | | Wattage | Diffuser | CCT | Lumen Output |
|---------------|----------|-------|-------|---------|-----------|-------|--------------|
| | Blk | Wht | Alu | | | | |
| MAXI-40-DN-FD | 27625 | 27630 | 27620 | 22W | Prismatic | 3000K | 2645lm |
| | 27626 | 27631 | 27621 | | Frosted | | |
| | 27627 | 27632 | 27622 | | Black | | |
| | 27628 | 27633 | 27623 | | Clear | | |
| MAXI-40-DN-FD | 27640 | 27645 | 27635 | 22W | Prismatic | 4000K | 2788lm |
| | 27641 | 27646 | 27636 | | Frosted | | |
| | 27642 | 27647 | 27637 | | Black | | |
| | 27643 | 27648 | 27638 | | Clear | | |

| Item No. | Variants | | | Wattage | Diffuser | CCT | Lumen Output |
|---------------|----------|-------|-------|---------|-----------|-------|--------------|
| | Blk | Wht | Alu | | | | |
| MAXI-40-WB-FD | 27715 | 27720 | 27710 | 22W | Prismatic | 3000K | 2645lm |
| | 27716 | 27721 | 27711 | | Frosted | | |
| | 27717 | 27722 | 27712 | | Black | | |
| | 27718 | 27723 | 27713 | | Clear | | |
| MAXI-40-WB-FD | 27730 | 27645 | 27725 | 22W | Prismatic | 4000K | 2788lm |
| | 27731 | 27646 | 27726 | | Frosted | | |
| | 27732 | 27647 | 27727 | | Black | | |
| | 27733 | 27648 | 27728 | | Clear | | |

Interior

Interior



Maxi-50 Recessed Series



- Profile includes Driver and Osram LED Boards.
- Sold Per Metre
- Inbuilt LED Driver.
- Aluminium profile and diffuser
- Made to order in Australia from local and imported components.
- DALI & DALI Tuneable white options available upon request.
- CRI90
- IP20 Indoor Use Only.
- Custom Lengths and Designs available upon request.

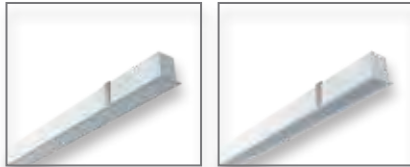

MAXI-50-REC-ALU MAXI-50-REC-WHT

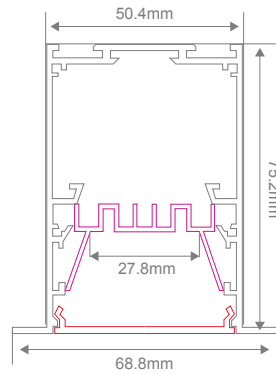

Maxi-50 Surface Mount Series



- Profile includes Driver and Osram LED Boards.
- Sold Per Metre
- Inbuilt LED Driver.
- Aluminium profile and diffuser
- Made to order in Australia from local and imported components.
- DALI & DALI Tuneable white options available upon request.
- CRI90
- IP20 Indoor Use Only.
- Custom Lengths and Designs available upon request.

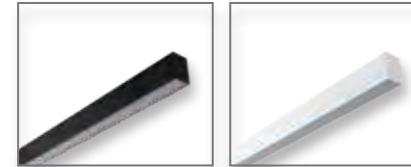

MAXI-50-SM-BLK MAXI-50-SM-WHT

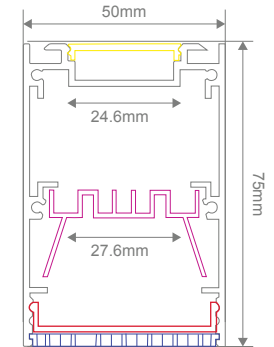

| Item No. | Variants | | | Wattage | Diffuser | CCT | Lumen Output |
|------------|----------|-------|-------|---------|-----------|-------|--------------|
| | Blk | Wht | Alu | | | | |
| MAXI-50-RC | 28437 | 28444 | 28430 | 22W | Prismatic | 3000K | 2645lm |
| | 28438 | 28445 | 28431 | | Frosted | | |
| | 28439 | 28446 | 28432 | | Honeycomb | | |
| | 28440 | 28447 | 28433 | | Opal | | |
| | 28441 | 28448 | 28434 | | Black | | |
| | 28442 | 28449 | 28435 | | Clear | | |
| MAXI-50-RC | 28458 | 28465 | 28451 | 22W | Prismatic | 4000K | 2788lm |
| | 28459 | 28466 | 28452 | | Frosted | | |
| | 28460 | 28467 | 28453 | | Honeycomb | | |
| | 28461 | 28468 | 28454 | | Opal | | |
| | 28462 | 28469 | 28455 | | Black | | |
| | 28463 | 28470 | 28456 | | Clear | | |

| Item No. | Variants | | | Wattage | Diffuser | CCT | Lumen Output |
|------------|----------|-------|-------|---------|-----------|-------|--------------|
| | Blk | Wht | Alu | | | | |
| MAXI-50-SM | 28227 | 28234 | 28220 | 22W | Prismatic | 3000K | 2645lm |
| | 28228 | 28235 | 28221 | | Frosted | | |
| | 28229 | 28236 | 28222 | | Honeycomb | | |
| | 28230 | 28237 | 28223 | | Opal | | |
| | 28231 | 28238 | 28224 | | Black | | |
| | 28232 | 28239 | 28225 | | Clear | | |
| MAXI-50-SM | 28248 | 28255 | 28241 | 22W | Prismatic | 4000K | 2788lm |
| | 28249 | 28256 | 28242 | | Frosted | | |
| | 28250 | 28257 | 28243 | | Honeycomb | | |
| | 28251 | 28258 | 28244 | | Opal | | |
| | 28252 | 28259 | 28245 | | Black | | |
| | 28253 | 28260 | 28246 | | Clear | | |



Maxi-50 Down Pendant Series

- Profile includes Driver and Osram LED Boards.
- Sold Per Metre
- Inbuilt LED Driver.
- Aluminium profile and diffuser
- Complete with 3m wire suspensions
- Made to order in Australia from local and imported components.
- DALI & DALI Tuneable white options available upon request.
- CRI90
- IP20 Indoor Use Only.
- Custom Lengths and Designs available upon request.

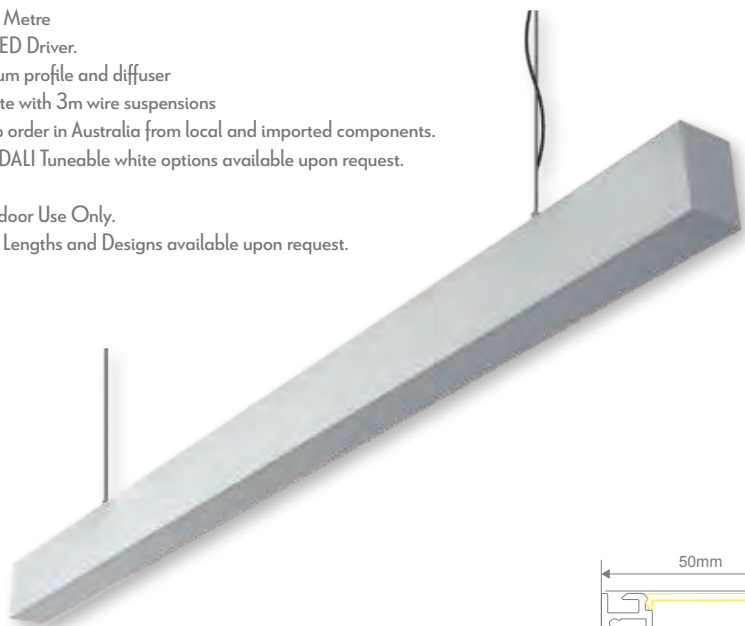

MAXI-50-DN-BLK MAXI-50-DN-WHT

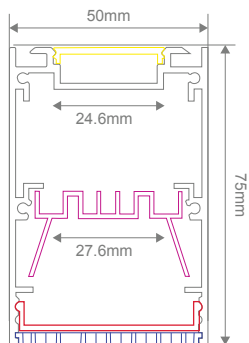

Maxi-50 Up/Down Pendant Series

- Profile includes Driver and Osram LED Boards.
- Sold Per Metre
- Inbuilt LED Driver.
- Aluminium profile and diffuser
- Complete with 3m wire suspensions and 3m clear power cable
- Made to order in Australia from local and imported components.
- DALI & DALI Tuneable white options available upon request.
- CRI90
- IP20 Indoor Use Only.
- Custom Lengths and Designs available upon request.



MAXI-50-UD-BLK MAXI-50-UD-WHT

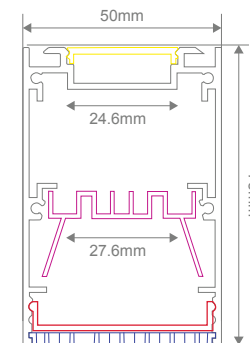

| Item No. | Variants | | | Wattage | Diffuser | CCT | Lumen Output |
|------------|----------|-------|-------|---------|-----------|-------|--------------|
| | Blk | Wht | Alu | | | | |
| MAXI-50-DN | 28269 | 28276 | 28262 | 22W | Prismatic | 3000K | 2645lm |
| | 28270 | 28277 | 28263 | | Frosted | | |
| | 28271 | 28278 | 28264 | | Honeycomb | | |
| | 28272 | 28279 | 28265 | | Opal | | |
| | 28273 | 28280 | 28266 | | Black | | |
| | 28274 | 28281 | 28267 | | Clear | | |
| MAXI-50-DN | 28290 | 28297 | 28283 | 22W | Prismatic | 4000K | 2788lm |
| | 28291 | 28298 | 28284 | | Frosted | | |
| | 28292 | 28299 | 28285 | | Honeycomb | | |
| | 28293 | 28300 | 28286 | | Opal | | |
| | 28294 | 28301 | 28287 | | Black | | |
| | 28295 | 28302 | 28288 | | Clear | | |

| Item No. | Variants | | | Wattage | Diffuser | CCT | Lumen Output |
|------------|----------|-------|-------|---------|-----------|-------|--------------|
| | Blk | Wht | Alu | | | | |
| MAXI-50-UD | 28311 | 28318 | 28304 | 2x22W | Prismatic | 3000K | 2x2645lm |
| | 28312 | 28319 | 28305 | | Frosted | | |
| | 28313 | 28320 | 28306 | | Honeycomb | | |
| | 28314 | 28321 | 28307 | | Opal | | |
| | 28315 | 28322 | 28308 | | Black | | |
| | 28316 | 28323 | 28309 | | Clear | | |
| MAXI-50-UD | 28332 | 28339 | 28325 | 2x22W | Prismatic | 4000K | 2x2788lm |
| | 28333 | 28340 | 28326 | | Frosted | | |
| | 28334 | 28341 | 28327 | | Honeycomb | | |
| | 28335 | 28342 | 28328 | | Opal | | |
| | 28336 | 28343 | 28329 | | Black | | |
| | 28337 | 28344 | 28330 | | Clear | | |



Maxi-50 Down Only Wall Bracket Series

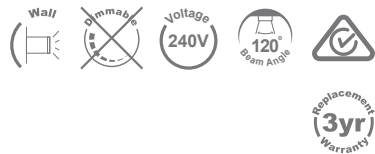

- Profile includes Driver and Osram LED Boards.
- Sold Per Metre
- Inbuilt LED Driver.
- Aluminium profile and diffuser
- Made to order in Australia from local and imported components.
- DALI & DALI Tuneable white options available upon request.
- CRI90
- IP20 Indoor Use Only.
- Custom Lengths and Designs available upon request.

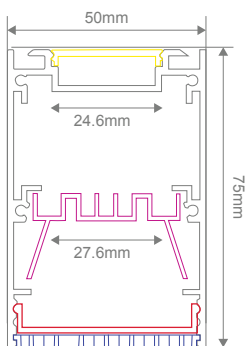

MAXI-50-WB-BLK



MAXI-50-WB-ALU

| Item No. | Variants | | | Wattage | Diffuser | CCT | Lumen Output |
|---------------|----------|-------|-------|---------|-----------|-------|--------------|
| | Blk | Wht | Alu | | | | |
| MAXI-50-WB-DN | 28353 | 28360 | 28346 | 22W | Prismatic | 3000K | 2645lm |
| | 28354 | 28361 | 28347 | | Frosted | | |
| | 28355 | 28362 | 28348 | | Honeycomb | | |
| | 28356 | 28363 | 28349 | | Opal | | |
| | 28357 | 28364 | 28350 | | Black | | |
| | 28358 | 28365 | 28351 | | Clear | | |
| MAXI-50-WB-DN | 28374 | 28381 | 28367 | 22W | Prismatic | 4000K | 2788lm |
| | 28375 | 28382 | 28368 | | Frosted | | |
| | 28376 | 28383 | 28369 | | Honeycomb | | |
| | 28377 | 28384 | 28370 | | Opal | | |
| | 28378 | 28385 | 28371 | | Black | | |
| | 28379 | 28386 | 28372 | | Clear | | |



Maxi-50 Up/Down Wall Bracket Series



- Profile includes Driver and Osram LED Boards.
- Sold Per Metre
- Inbuilt LED Driver.
- Aluminium profile and diffuser
- Complete with 3m wire suspensions
- Made to order in Australia from local and imported components.
- DALI & DALI Tuneable white options available upon request.
- CRI90
- IP20 Indoor Use Only.
- Custom Lengths and Designs available upon request.

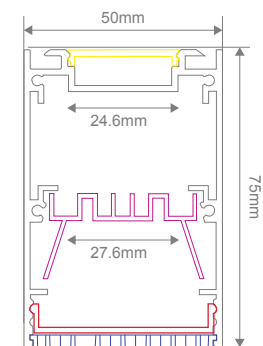
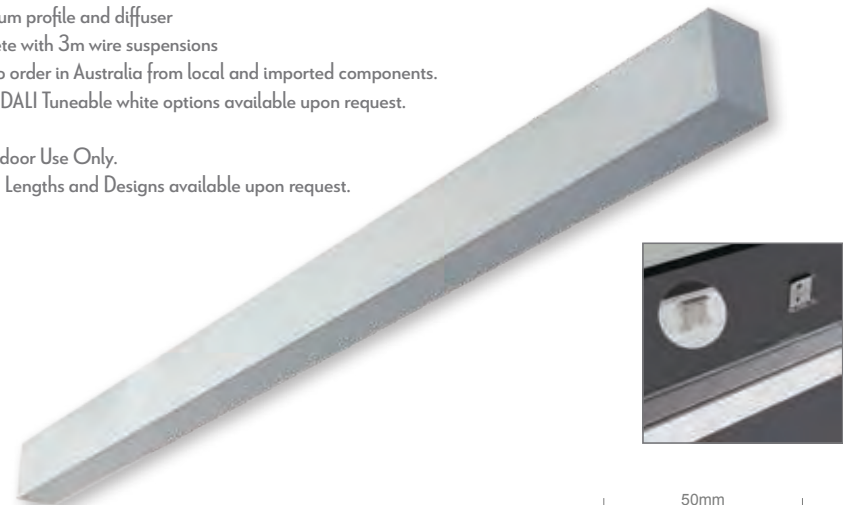

MAXI-50-WB-UD-BLK



MAXI-50-WB-UD-WHT

| Item No. | Variants | | | Wattage | Diffuser | CCT | Lumen Output |
|---------------|----------|-------|-------|---------|-----------|-------|--------------|
| | Blk | Wht | Alu | | | | |
| MAXI-50-WB-UD | 28395 | 28402 | 28388 | 2x22W | Prismatic | 3000K | 2x2645lm |
| | 28396 | 28403 | 28389 | | Frosted | | |
| | 28397 | 28404 | 28390 | | Honeycomb | | |
| | 28398 | 28405 | 28391 | | Opal | | |
| | 28399 | 28406 | 28392 | | Black | | |
| | 28400 | 28407 | 28393 | | Clear | | |
| MAXI-50-WB-UD | 28416 | 28423 | 28409 | 2x22W | Prismatic | 4000K | 2x2788lm |
| | 28417 | 28424 | 28410 | | Frosted | | |
| | 28418 | 28425 | 28411 | | Honeycomb | | |
| | 28419 | 28426 | 28412 | | Opal | | |
| | 28420 | 28427 | 28413 | | Black | | |
| | 28421 | 28428 | 28414 | | Clear | | |



Maxi-Curve Surface Mount Series



- Profile includes Driver and Osram LED Boards.
- Sold Per Metre
- Inbuilt LED Driver.
- Aluminium profile and diffuser
- Complete with 3m wire suspensions
- Made to order in Australia from local and imported components.
- DALI & DALI Tuneable white options available upon request.
- CRI90
- IP20 Indoor Use Only.
- Custom Lengths and Designs available upon request.

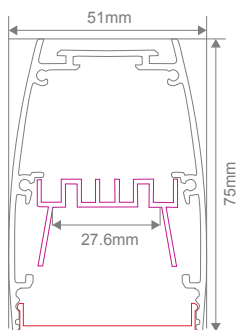

MAXI-CURVE-SM-BLK



MAXI-CURVE-SM-WHT

| Item No. | Variants | | | Wattage | Diffuser | CCT | Lumen Output |
|-------------|----------|-------|-------|---------|-----------|-------|--------------|
| | Blk | Wht | Alu | | | | |
| MAXI-CUR-SM | 28731 | 28738 | 28724 | 22W | Prismatic | 3000K | 2645lm |
| | 28732 | 28739 | 28725 | | Frosted | | |
| | 28733 | 28740 | 28726 | | Honeycomb | | |
| | 28734 | 28741 | 28727 | | Opal | | |
| | 28735 | 28742 | 28728 | | Black | | |
| | 28736 | 28743 | 28729 | | Clear | | |
| MAXI-CUR-SM | 28752 | 28759 | 28745 | 22W | Prismatic | 4000K | 2788lm |
| | 28753 | 28760 | 28746 | | Frosted | | |
| | 28754 | 28761 | 28747 | | Honeycomb | | |
| | 28755 | 28762 | 28748 | | Opal | | |
| | 28756 | 28763 | 28749 | | Black | | |
| | 28757 | 28764 | 28750 | | Clear | | |



Maxi-Curve Pendant Series

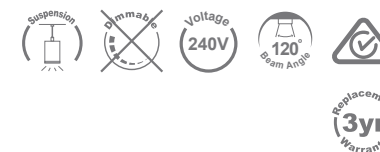

- Profile includes Driver and Osram LED Boards.
- Sold Per Metre
- Inbuilt LED Driver.
- Aluminium profile and diffuser
- Complete with 3m wire suspensions
- Made to order in Australia from local and imported components.
- DALI & DALI Tuneable white options available upon request.
- CRI90
- IP20 Indoor Use Only.
- Custom Lengths and Designs available upon request.

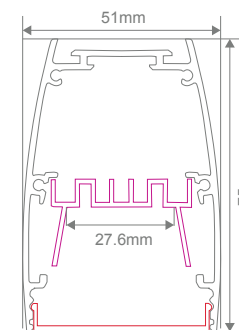

MAXI-CURVE-DN-BLK



MAXI-CURVE-DN-WHT

| Item No. | Variants | | | Wattage | Diffuser | CCT | Lumen Output |
|-------------|----------|-------|-------|---------|-----------|-------|--------------|
| | Blk | Wht | Alu | | | | |
| MAXI-CUR-DN | 28773 | 28780 | 28766 | 22W | Prismatic | 3000K | 2645lm |
| | 28774 | 28781 | 28767 | | Frosted | | |
| | 28775 | 28782 | 28768 | | Honeycomb | | |
| | 28776 | 28783 | 28769 | | Opal | | |
| | 28777 | 28784 | 28770 | | Black | | |
| | 28778 | 28785 | 28771 | | Clear | | |
| MAXI-CUR-DN | 28794 | 28801 | 28787 | 22W | Prismatic | 4000K | 2788lm |
| | 28795 | 28802 | 28788 | | Frosted | | |
| | 28796 | 28803 | 28789 | | Honeycomb | | |
| | 28797 | 28804 | 28790 | | Opal | | |
| | 28798 | 28805 | 28791 | | Black | | |
| | 28799 | 28806 | 28792 | | Clear | | |



Maxi-75 Recessed Series



- Profile includes Driver and Osram LED Boards.
- Sold Per Metre
- Inbuilt LED Driver.
- Aluminium profile and diffuser
- Made to order in Australia from local and imported components.
- DALI & DALI Tuneable white options available upon request.
- CRI90
- IP20 Indoor Use Only.
- Custom Lengths and Designs available upon request.

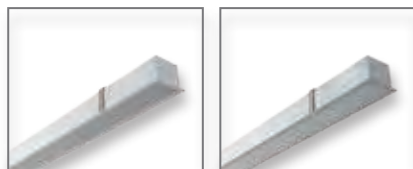

MAXI-75-REC-WHT

MAXI-75-REC-ALU

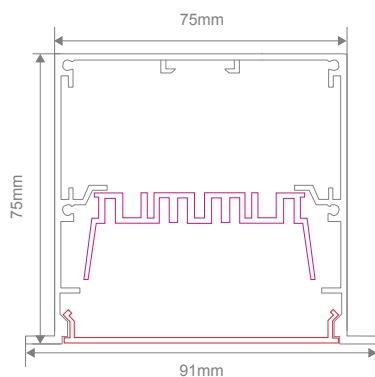

Maxi-75 Surface Mount Series

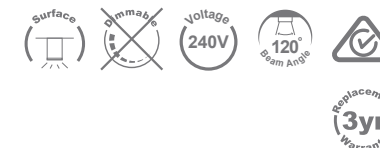

- Profile includes Driver and Osram LED Boards.
- Sold Per Metre
- Inbuilt LED Driver.
- Aluminium profile and diffuser
- Made to order in Australia from local and imported components.
- DALI & DALI Tuneable white options available upon request.
- CRI90
- IP20 Indoor Use Only.
- Custom Lengths and Designs available upon request.

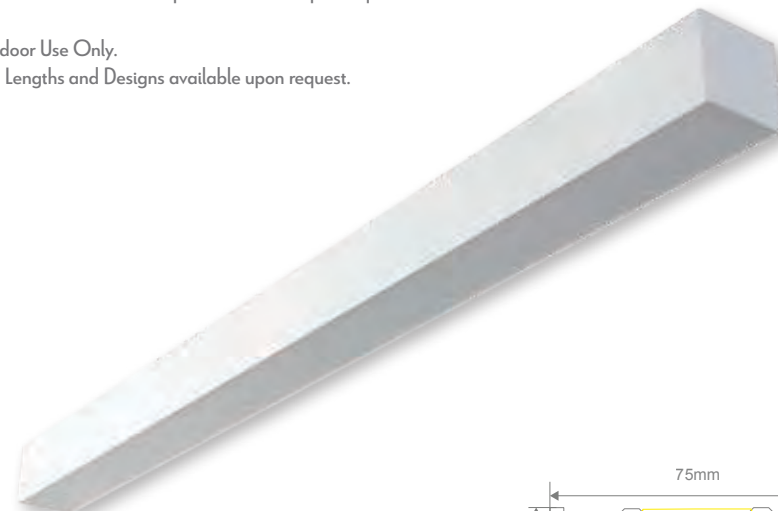

MAXI-75-SM-BLK

MAXI-75-SM-ALU

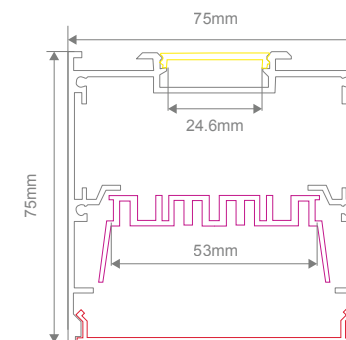

| Item No. | Variants | | | Wattage | Diffuser | CCT | Lumen Output |
|-------------|----------|-------|-------|---------|-----------|-------|--------------|
| | Blk | Wht | Alu | | | | |
| MAXI-75-REC | 29078 | 29084 | 29072 | 22W | Prismatic | 3000K | 2645lm |
| | 29079 | 29085 | 29073 | | Frosted | | |
| | 29080 | 29086 | 29074 | | Opal | | |
| | 29081 | 29087 | 29075 | | Black | | |
| | 29082 | 29088 | 29076 | | Clear | | |
| MAXI-75-REC | 29096 | 29102 | 29090 | 22W | Prismatic | 4000K | 2788lm |
| | 29097 | 29103 | 29091 | | Frosted | | |
| | 29098 | 29104 | 29092 | | Opal | | |
| | 29099 | 29105 | 29093 | | Black | | |
| | 29100 | 29106 | 29094 | | Clear | | |

| Item No. | Variants | | | Wattage | Diffuser | CCT | Lumen Output |
|------------|----------|-------|-------|---------|-----------|-------|--------------|
| | Blk | Wht | Alu | | | | |
| MAXI-75-SM | 28898 | 28904 | 28892 | 22W | Prismatic | 3000K | 2645lm |
| | 28899 | 28905 | 28893 | | Frosted | | |
| | 28900 | 28906 | 28894 | | Opal | | |
| | 28901 | 28907 | 28895 | | Black | | |
| | 28902 | 28908 | 28896 | | Clear | | |
| MAXI-75-SM | 28916 | 28922 | 28910 | 22W | Prismatic | 4000K | 2788lm |
| | 28917 | 28923 | 28911 | | Frosted | | |
| | 28918 | 28924 | 28912 | | Opal | | |
| | 28919 | 28925 | 28913 | | Black | | |
| | 28920 | 28926 | 28914 | | Clear | | |



Maxi-75 Down Pendant Series

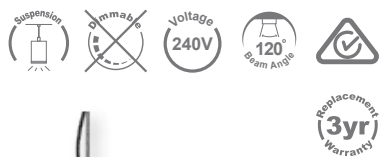

- Profile includes Driver and Osram LED Boards.
- Sold Per Metre
- Inbuilt LED Driver.
- Aluminium profile and diffuser
- Complete with 3m wire suspensions
- Made to order in Australia from local and imported components.
- DALI & DALI Tuneable white options available upon request.
- CRI90
- IP20 Indoor Use Only.
- Custom Lengths and Designs available upon request.

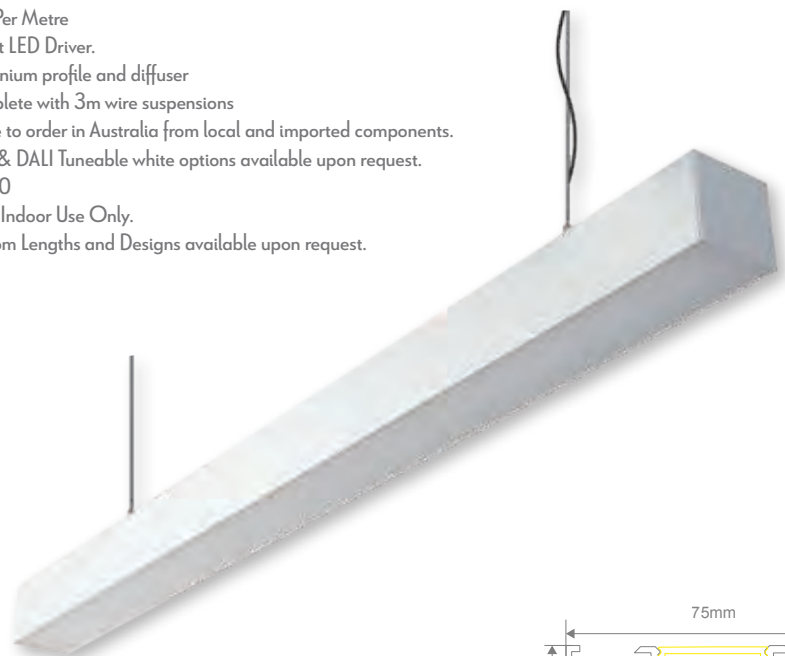

MAXI-75-DN-BLK

MAXI-75-DN-WHT

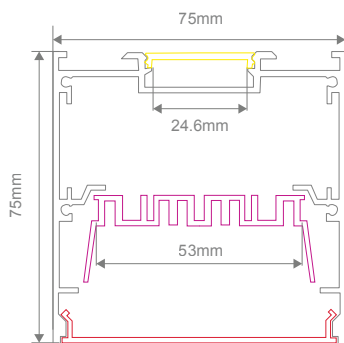

Maxi-75 Up/Down Pendant Series



- Profile includes Driver and Osram LED Boards.
- Sold Per Metre
- Inbuilt LED Driver.
- Aluminium profile and diffuser
- Complete with 3m wire suspensions
- Made to order in Australia from local and imported components.
- DALI & DALI Tuneable white options available upon request.
- CRI90
- IP20 Indoor Use Only.
- Custom Lengths and Designs available upon request.

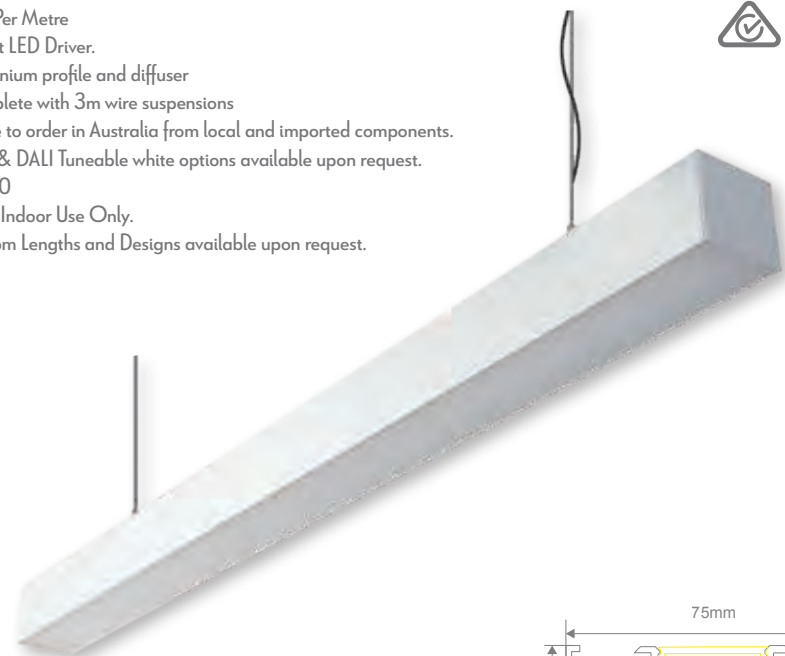

MAXI-75-UD-BLK

MAXI-75-UD-WHT

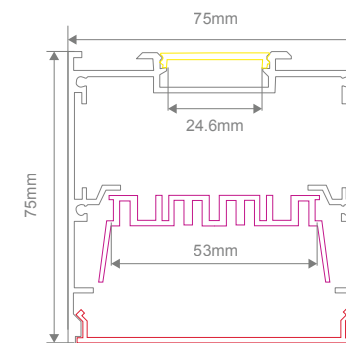

| Item No. | Variants | | | Wattage | Diffuser | CCT | Lumen Output |
|------------|----------|-------|-------|---------|-----------|-------|--------------|
| | Blk | Wht | Alu | | | | |
| MAXI-75-DN | 28934 | 28940 | 28928 | 22W | Prismatic | 3000K | 2645lm |
| | 28935 | 28941 | 28929 | | Frosted | | |
| | 28936 | 28942 | 28930 | | Opal | | |
| | 28937 | 28943 | 28931 | | Black | | |
| | 28938 | 28944 | 28932 | | Clear | | |
| MAXI-75-DN | 28952 | 28958 | 28946 | 22W | Prismatic | 4000K | 2788lm |
| | 28953 | 28959 | 28947 | | Frosted | | |
| | 28954 | 28960 | 28948 | | Opal | | |
| | 28955 | 28961 | 28949 | | Black | | |
| | 28956 | 28962 | 28950 | | Clear | | |

| Item No. | Variants | | | Wattage | Diffuser | CCT | Lumen Output |
|------------|----------|-------|-------|---------|-----------|-------|--------------|
| | Blk | Wht | Alu | | | | |
| MAXI-75-UD | 28970 | 28976 | 28964 | 2x22W | Prismatic | 3000K | 2x2645lm |
| | 28971 | 28977 | 28965 | | Frosted | | |
| | 28972 | 28978 | 28966 | | Opal | | |
| | 28973 | 28979 | 28967 | | Black | | |
| | 28974 | 28980 | 28968 | | Clear | | |
| MAXI-75-UD | 28970 | 28976 | 28964 | 2x22W | Prismatic | 4000K | 2x2788lm |
| | 28971 | 28977 | 28965 | | Frosted | | |
| | 28972 | 28978 | 28966 | | Opal | | |
| | 28973 | 28979 | 28967 | | Black | | |
| | 28974 | 28980 | 28968 | | Clear | | |



Maxi-75 Down Only Wall Bracket Series



- Profile includes Driver and Osram LED Boards.
- Sold Per Metre
- Inbuilt LED Driver.
- Aluminium profile and diffuser
- Complete with 3m wire suspensions
- Made to order in Australia from local and imported components.
- DALI & DALI Tuneable white options available upon request.
- CRI90
- IP20 Indoor Use Only.
- Custom Lengths and Designs available upon request.

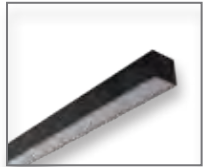
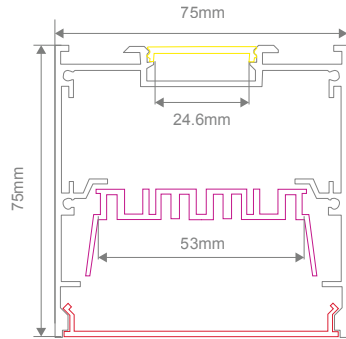

MAXI-75-WB-BLK

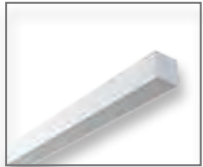

MAXI-75-WB-WHT

| Item No. | Variants | | | Wattage | Diffuser | CCT | Lumen Output |
|---------------|----------|-------|-------|---------|-----------|-------|--------------|
| | Blk | Wht | Alu | | | | |
| MAXI-75-WB-DN | 29006 | 29012 | 29000 | 22W | Prismatic | 3000K | 2645lm |
| | 29007 | 29013 | 29001 | | Frosted | | |
| | 29008 | 29014 | 29002 | | Opal | | |
| | 29009 | 29015 | 29003 | | Black | | |
| | 29010 | 29016 | 29004 | | Clear | | |
| MAXI-75-WB-DN | 29024 | 29030 | 29018 | 22W | Prismatic | 4000K | 2788lm |
| | 29025 | 29031 | 29019 | | Frosted | | |
| | 29026 | 29032 | 29020 | | Opal | | |
| | 29027 | 29033 | 29021 | | Black | | |
| | 29028 | 29034 | 29022 | | Clear | | |



Maxi-75 Up/Down Wall Bracket Series



- Profile includes Driver and Osram LED Boards.
- Sold Per Metre
- Inbuilt LED Driver.
- Aluminium profile and diffuser
- Complete with 3m wire suspensions
- Made to order in Australia from local and imported components.
- DALI & DALI Tuneable white options available upon request.
- CRI90
- IP20 Indoor Use Only.
- Custom Lengths and Designs available upon request.

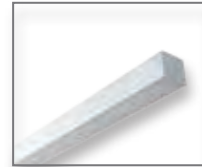
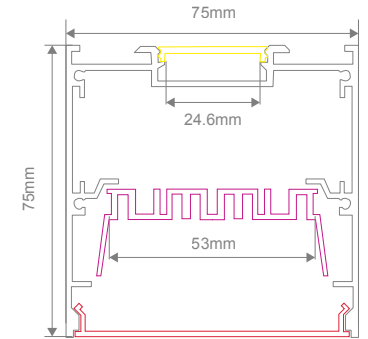

MAXI-75-WB-UD-ALU

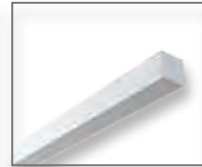

MAXI-75-WB-UD-WHT

| Item No. | Variants | | | Wattage | Diffuser | CCT | Lumen Output |
|---------------|----------|-------|-------|---------|-----------|-------|--------------|
| | Blk | Wht | Alu | | | | |
| MAXI-75-WB-UD | 29042 | 29048 | 29036 | 2x22W | Prismatic | 3000K | 2x2645lm |
| | 29043 | 29049 | 29037 | | Frosted | | |
| | 29044 | 29050 | 29038 | | Opal | | |
| | 29045 | 29051 | 29039 | | Black | | |
| | 29046 | 29052 | 29040 | | Clear | | |
| MAXI-75-WB-UD | 29060 | 29066 | 29054 | 2x22W | Prismatic | 4000K | 2x2788lm |
| | 29061 | 29067 | 29055 | | Frosted | | |
| | 29062 | 29068 | 29056 | | Opal | | |
| | 29063 | 29069 | 29057 | | Black | | |
| | 29064 | 29070 | 29058 | | Clear | | |



LED Oysters



Mondo Round Series

- Polycarbonate Body and Diffuser.
- Fully dimmable with suitable dimmers.
- Double Insulated
- Class II (No Earth Required)

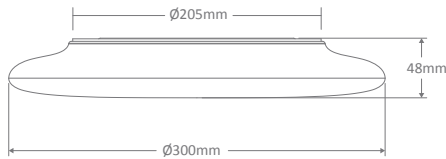

MONDO-300

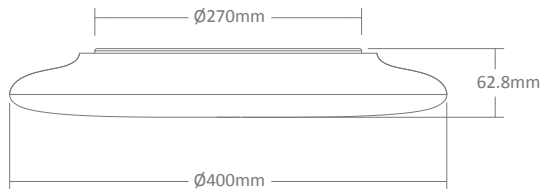

MONDO-400

| Item No. | Variants | | | IP Rating | Lumen Output | | |
|-----------|----------|---------|------|-----------|------------------|---------------------|-------------|
| | Opal | Wattage | CCT | | Warm White 3000K | Neutral White 4000K | White 5700K |
| MONDO-300 | 20873 | 20W | TRIO | 44 | 1700lm | 1750lm | 1800lm |
| MONDO-400 | 20879 | 30W | TRIO | 44 | 2400lm | 2450lm | 2500lm |



LED Oysters



Solar Round Series

- Polycarbonate Body and Diffuser.
- Fully dimmable with suitable dimmers.
- Double Insulated
- Class II (No Earth Required)



SOLAR-RND-200

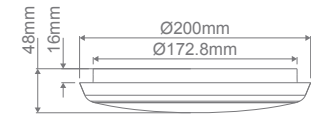

SOLAR-RND-300

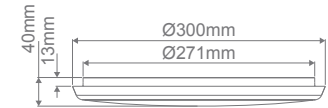

SOLAR-RND-400

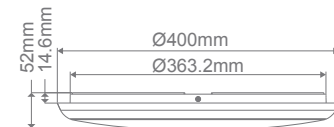

| Item No. | Variants | | Wattage | IP Rating | CCT | Lumen Output | | |
|---------------|----------|-------|---------|-----------|------|------------------|---------------------|-------------|
| | Wht | Blk | | | | Warm White 3000K | Neutral White 4000K | White 5700K |
| SOLAR-200-RND | 20938 | 20939 | 15W | 54 | TRIO | 1350lm | 1400lm | 1450lm |
| SOLAR-300-RND | 20940 | 20941 | 25W | 54 | TRIO | 2250lm | 2300lm | 2350lm |
| SOLAR-400-RND | 20942 | 20943 | 35W | 54 | TRIO | 3150lm | 3200lm | 3250lm |



LED Oysters



Solar Square Series

- Polycarbonate Body and Diffuser.
- Fully dimmable with suitable dimmers.
- Double Insulated
- Class II (No Earth Required)



SOLAR-SQR-300



SOLAR-SQR-400

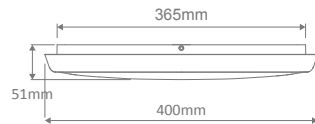
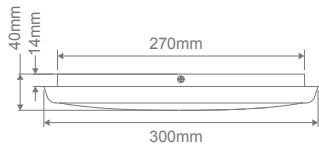

LED Oysters



Easy Series

- Polycarbonate Body and Diffuser.
- Fully dimmable with suitable dimmers.
- Double Insulated
- Class II (No Earth Required)



EASY-250

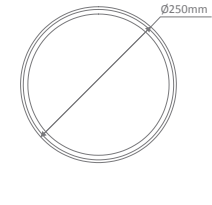

EASY-300

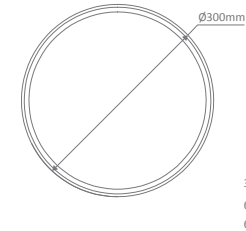

EASY-400

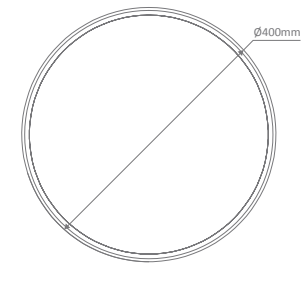

| Item No. | Variants | | Wattage | IP Rating | CCT | Lumen Output | | |
|---------------|----------|-------|---------|-----------|------|------------------|---------------------|-------------|
| | Blk | Wht | | | | Warm White 3000K | Neutral White 4000K | White 5700K |
| SOLAR-300-SQR | 20946 | 20944 | 25W | 54 | TRIO | 2250lm | 2300lm | 2350lm |
| SOLAR-400-SQR | 20947 | 20945 | 35W | 54 | TRIO | 3000lm | 3050lm | 3100lm |

| Item No. | Variants | | Wattage | IP Rating | CCT | Lumen Output | | |
|--------------|----------|--|---------|-----------|------|------------------|---------------------|-------------|
| | Wht | | | | | Warm White 3000K | Neutral White 4000K | White 5700K |
| EASY-250-RND | 20954 | | 10W | 54 | TRIO | 930lm | 965lm | 1000lm |
| EASY-300-RND | 20955 | | 18W | 54 | TRIO | 1500lm | 1600lm | 1820lm |
| EASY-400-RND | 20956 | | 25W | 54 | TRIO | 2220lm | 2435lm | 2650lm |



Sunset Series

- Polycarbonate Body and Diffuser.
- Fully dimmable with suitable dimmers.
- Available in Sensor and Emergency Models (SUNSET-300-RND)
- Double Insulated
- Class II (No Earth Required)



SUNSET-RND



SUNSET-SQR

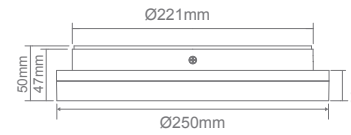

SUNSET-250-RND

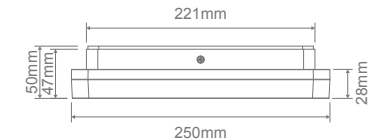

SUNSET-250-SQR

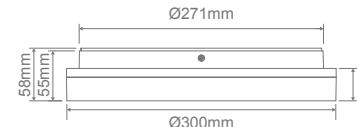

SUNSET-300-RND

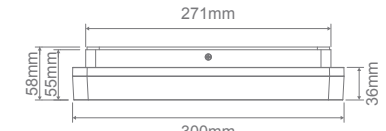

SUNSET-300-SQR



SUNSET-400-RND

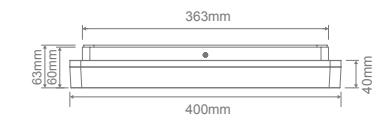

SUNSET-400-SQR

| Item No. | Variants Stn Wht | Wattage | CCT | IP Rating | Lumen Output | | |
|----------------|---------------------|---------|------|-----------|---------------------|------------------------|----------------|
| | | | | | Warm White 3000K | Neutral White 4000K | White 5700K |
| SUNSET-250-RND | 20880 | 15W | TRIO | 54 | 1300lm | 1400lm | 1320lm |
| SUNSET-300-RND | 20881 | 25W | TRIO | 54 | 2160lm | 2410lm | 2200lm |
| SUNSET-400-RND | 20882 | 35W | TRIO | 54 | 3020lm | 3420lm | 3240lm |
| SUNSET-250-SQR | 20886 | 15W | TRIO | 54 | 1430lm | 1520lm | 1460lm |
| SUNSET-300-SQR | 20887 | 25W | TRIO | 54 | 2380lm | 2620lm | 2490lm |
| SUNSET-400-SQR | 20888 | 35W | TRIO | 54 | 3300lm | 3570lm | 3380lm |



LED Panel



Panel Backlit Series

- White trim frame.
- DALI option now available, production lead times apply.
- CRI 80



LED Panel

Available Sizes

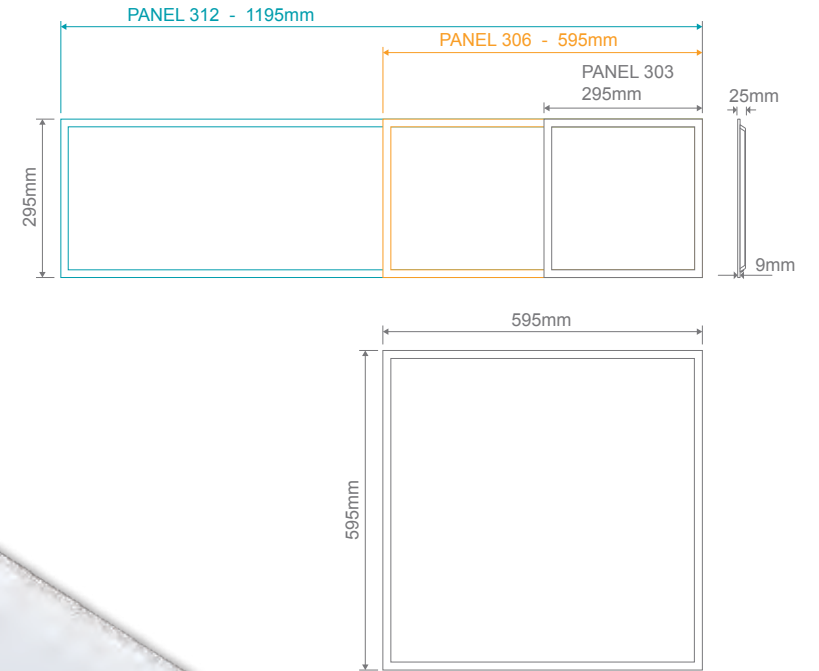

| Item No. | Variants | | Wattage | IP Rating | CCT | Lumen Output | | |
|---------------|----------|-------|---------|-----------|------|------------------|---------------------|-------------|
| | Standard | DALI | | | | Warm White 3000K | Neutral White 4000K | White 5700K |
| PANEL-BLT-303 | 17615 | 21645 | 10W | 20 | TRIO | 900lm | 1050lm | 1000lm |
| PANEL-BLT-306 | 17617 | 21646 | 12W | 20 | TRIO | 1200lm | 1320lm | 1250lm |
| PANEL-BLT-312 | 17619 | 21647 | 30W | 20 | TRIO | 3500lm | 3600lm | 3550lm |
| PANEL-BLT-606 | 17621 | 21648 | 30W | 20 | TRIO | 3500lm | 3600lm | 3550lm |

Interior

Interior



LED Panel Recessed Plaster Frames



- Satin White metal frame.
- To suit Plaster ceilings.



TRIM-606

| Item No. | Variants | Frame Dimensions | Cutout |
|----------|----------|------------------------|------------------|
| TRIM-303 | 19324 | (L)330x(W)330x(H)41mm | (L)310x(W)310mm |
| TRIM-306 | 19325 | (L)630x(W)330x(H)41mm | (L)610x(W)310mm |
| TRIM-312 | 19326 | (L)1230x(W)330x(H)41mm | (L)1210x(W)310mm |
| TRIM-606 | 19327 | (L)630x(W)630x(H)41mm | (L)610x(W)610mm |

LED Panel Surface Mount Frames



- Satin White frame.
- To suit surface mounted applications.
- Also require when suspending the panel in conjunction with 4 x suspension kits.

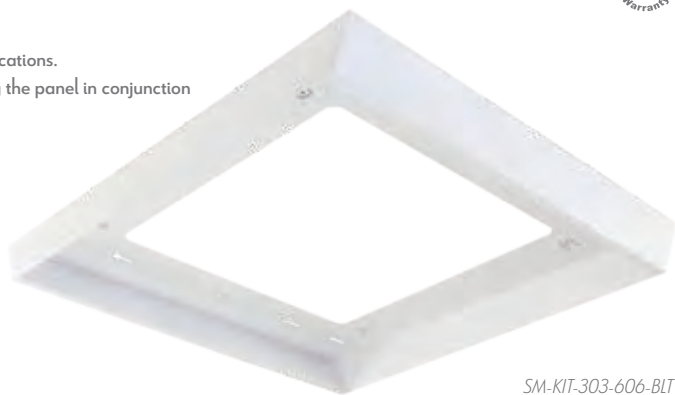

SM-KIT-303-606-BLT

| Item No. | Variants | Frame Dimensions |
|----------------|----------|------------------------|
| SM-KIT-303-BLT | 19340 | (L)300x(W)355x(H)66mm |
| SM-KIT-306-BLT | 19341 | (L)600x(W)355x(H)66mm |
| SM-KIT-312-BLT | 19342 | (L)1200x(W)355x(H)66mm |
| SM-KIT-606-BLT | 19343 | (L)600x(W)655x(H)66mm |



LED Panel Surface Mount Frames Installation Guide

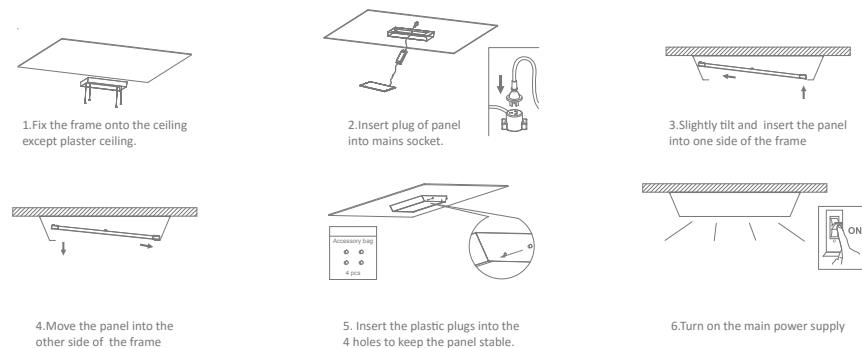

LED Panel Wire Suspension Kit



| Item No. | Variants | Length |
|-------------|----------|-------------------------------|
| SUSP-KIT-2M | 22041 | 2M Wire Suspension Kit (each) |
| SUS-KIT-3M | 22044 | 3M Wire Suspension Kit (each) |

Minimum 4 required per surface mount frame

Interior

Interior





Moon Track Series

- SMD LED Chip.
- 6W/9W Power Switchable.
- 45° Tiltable, 355° Rotatable.
- Fully dimmable with suitable dimmers.
- Optional coloured baffles available for Tube or Spot Reflectors.
- CRI 90

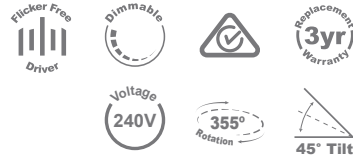

MOON-TRK-SPOT

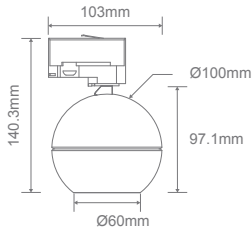

MOON-TRK-TUBE

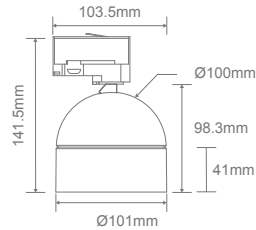

MOON-TRK-OPAL

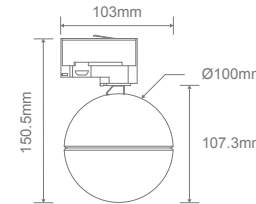

MOON-TRK-FLD

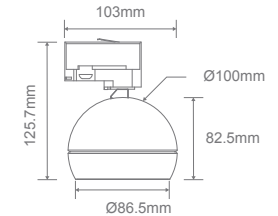

| Item No. | Variants | | Wattage | IP | CCT |
|----------|----------|-------------|---------|----|------|
| | Blk | Wht | | | |
| MOON-TRK | FLD | 22796 22797 | 6/9W | 20 | TRIO |
| | OPAL | 22798 22799 | | | |
| | SPOT | 22800 22801 | | | |
| | TUBE | 22802 22803 | | | |

| 6W - Lumen Output | | | | | | | | | | | |
|-------------------|-----------|----------|----------|---------------------|-----------|----------|----------|-------------|-----------|----------|----------|
| Warm White 3000K | | | | Neutral White 4000K | | | | White 5700K | | | |
| Fld-60° | Opal-130° | Spot-30° | Tube-60° | Fld-60° | Opal-130° | Spot-30° | Tube-60° | Fld-60° | Opal-130° | Spot-30° | Tube-60° |
| 477lm | 433lm | 498lm | 430lm | 556lm | 504lm | 534lm | 504lm | 561lm | 513lm | 536lm | 515lm |

| 9W - Lumen Output | | | | | | | | | | | |
|-------------------|-----------|----------|----------|---------------------|-----------|----------|----------|-------------|-----------|----------|----------|
| Warm White 3000K | | | | Neutral White 4000K | | | | White 5700K | | | |
| Fld-60° | Opal-130° | Spot-30° | Tube-60° | Fld-60° | Opal-130° | Spot-30° | Tube-60° | Fld-60° | Opal-130° | Spot-30° | Tube-60° |
| 651lm | 600lm | 661lm | 593lm | 780lm | 719lm | 756lm | 716lm | 775lm | 729lm | 751lm | 708lm |

Up to 45° tilt, 355° Rotation

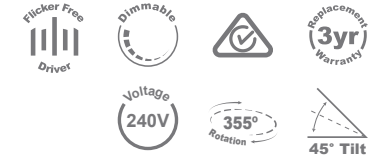
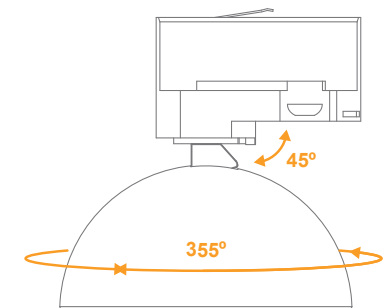



Moon Track Pendant Series

- SMD LED Chip.
- 6W/9W Power Switchable.
- 45° Tiltable, 355° Rotatable.
- Fully dimmable with suitable dimmers.
- Optional coloured baffles available for Tube or Spot Reflectors.
- CRI 90

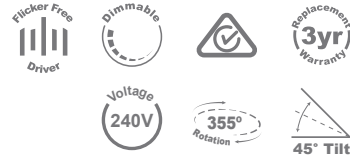

Up to 45° tilt,
355° Rotation

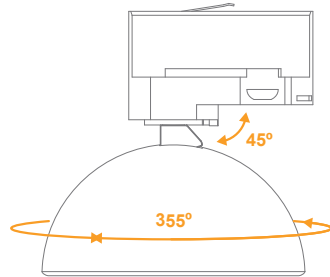

| Item No. | Variants | | Wattage | IP | CCT | |
|--------------|----------|-------|---------|------|-----|------|
| | Blk | Wht | | | | |
| MOON-TRK-PDT | FLD | 22788 | 22789 | 6/9W | 20 | TRIO |
| | OPAL | 22790 | 22791 | | | |
| | SPOT | 22792 | 22793 | | | |
| | TUBE | 22794 | 22795 | | | |

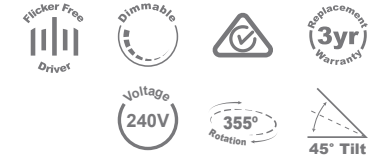

| 6W - Lumen Output | | | | | | | | | | | |
|-------------------|-----------|----------|----------|---------------------|-----------|----------|----------|-------------|-----------|----------|----------|
| Warm White 3000K | | | | Neutral White 4000K | | | | White 5700K | | | |
| Flt-60° | Opal-130° | Spot-30° | Tube-60° | Flt-60° | Opal-130° | Spot-30° | Tube-60° | Flt-60° | Opal-130° | Spot-30° | Tube-60° |
| 477lm | 433lm | 498lm | 430lm | 556lm | 504lm | 534lm | 504lm | 561lm | 513lm | 536lm | 515lm |

| 9W - Lumen Output | | | | | | | | | | | |
|-------------------|-----------|----------|----------|---------------------|-----------|----------|----------|-------------|-----------|----------|----------|
| Warm White 3000K | | | | Neutral White 4000K | | | | White 5700K | | | |
| Flt-60° | Opal-130° | Spot-30° | Tube-60° | Flt-60° | Opal-130° | Spot-30° | Tube-60° | Flt-60° | Opal-130° | Spot-30° | Tube-60° |
| 651lm | 600lm | 661lm | 593lm | 780lm | 719lm | 756lm | 716lm | 775lm | 729lm | 751lm | 708lm |

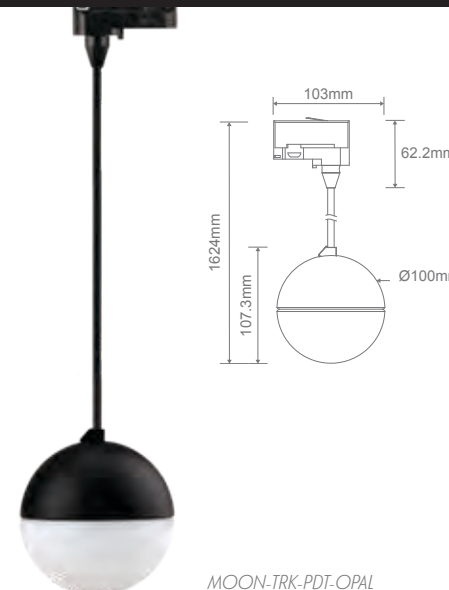
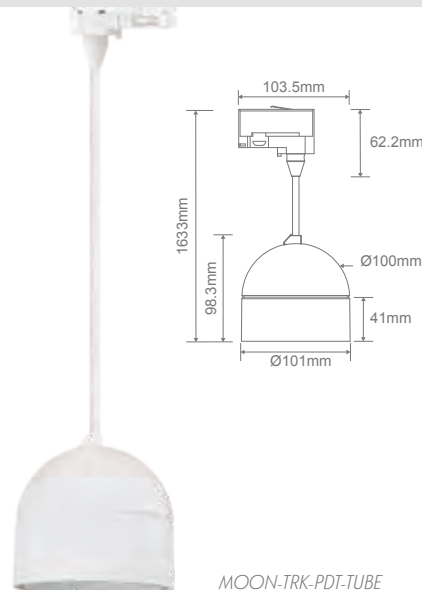
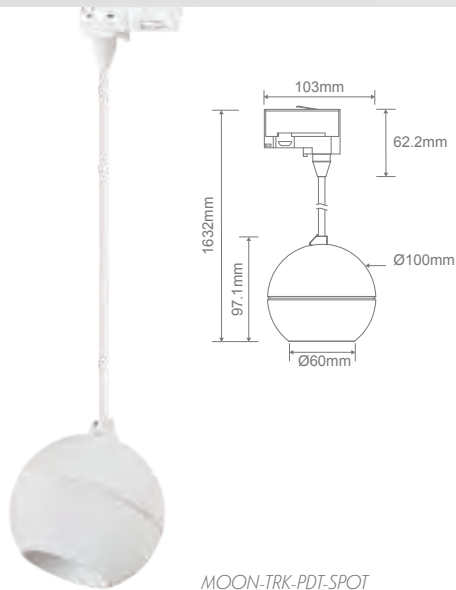



LED Track Lights

Thor Series



- To suit 3-circuit 240V Track.
- Fully dimmable with suitable dimmers.
- Black model comes standard with black baffle and 36 degree lens.
- White model comes standard with white baffle and 36 degree lens.



THOR-35

THOR-25

THOR-15

Thor Series



LED Track Lights

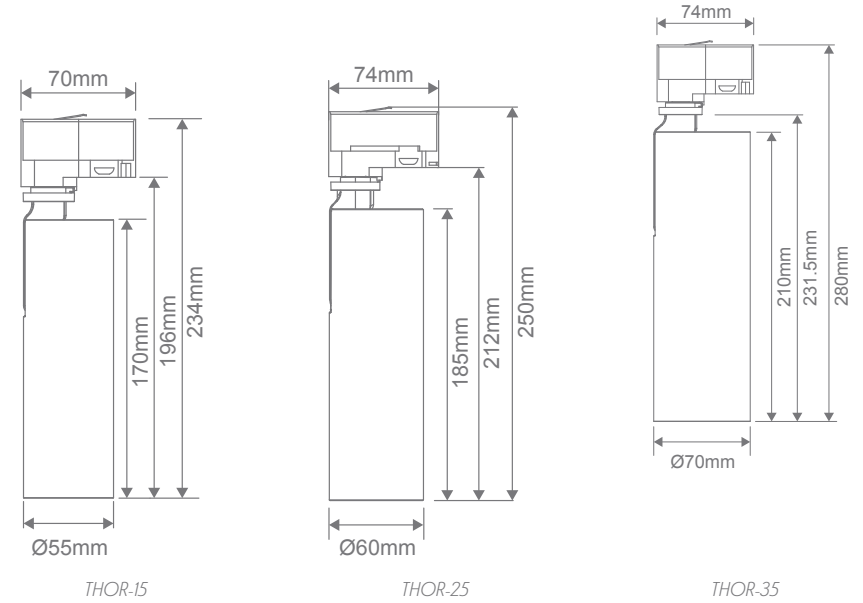

| Item No. | Variants | | | | | | IP Rating | CCT | Lumen Output | | |
|----------|----------|-------|-------|-------|-------|-------|-----------|-------|--------------|--------|--------|
| | 15W | | 25W | | 35W | | | | 15W | 25W | 35W |
| | Blk | Wht | Blk | Wht | Blk | Wht | | | | | |
| THOR | 22250 | 22255 | 22410 | 22414 | 22418 | 22422 | 20 | 3000K | 1068lm | 1751lm | 2950lm |
| | 22251 | 22256 | 22411 | 22415 | 22419 | 22423 | | 4000K | 1147lm | 2011lm | 2990lm |

Interior

Interior

| | |
|---------------|---------|
| Short Black | \$ 3.50 |
| Long Black | \$ 3.90 |
| Flat White | \$ 4.00 |
| Cappuccino | \$ 4.10 |
| Latte | \$ 4.20 |
| Mocha | \$ 4.50 |
| Macchiato | \$ 3.70 |
| Vienna | \$ 4.20 |
| Hot Chocolate | \$ 4.00 |





Trak-3 Series

- Three Circuit 240V Track.
- Available in 1m or 2m lengths.

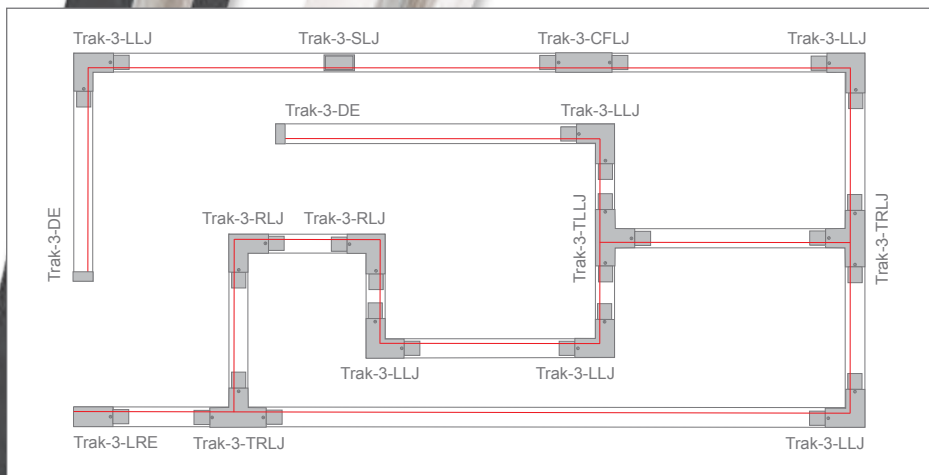
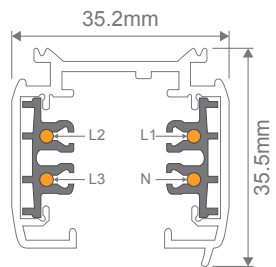

(LRE) Live Right End (LLJ) L Shape Left Live Joiner (TRLJ) T Shape Right Live Joiner
 (LLE) Live Left End (RLJ) L Shape Right Live Joiner (ADA) Adaptor
 (DE) Dead End (SDJ) Straight Dead Joiner (CFJ) Centre Feed Live Joiner
 (SLJ) Straight Live Joiner (TLLJ) T Shape Left Live Joiner

| Item No. | Variants | | Voltage | IP Rating | Length |
|------------|----------|-------|---------|-----------|--------|
| | Blk | Wht | | | |
| TRAK-3-S1M | 22152 | 22153 | 240V | 20 | 1M |
| TRAK-3-S2M | 22150 | 22151 | 240V | 20 | 2M |



Trak-3 Accessories

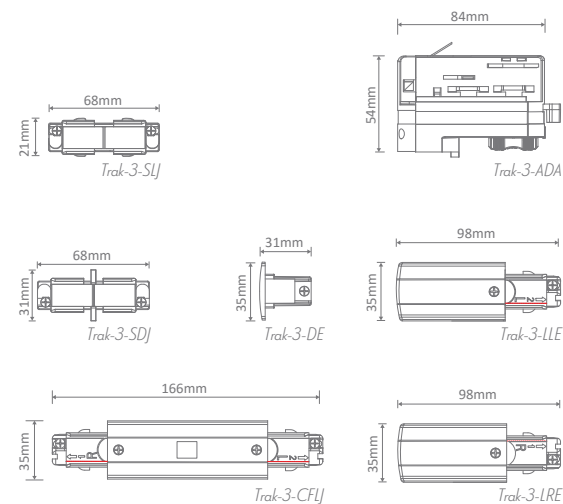

| Item No. | Variants | |
|-------------|----------|-------|
| | Black | White |
| TRAK-3-SLJ | 22162 | 22163 |
| TRAK-3-SDJ | 22170 | 22171 |
| TRAK-3-DE | 22160 | 22161 |
| TRAK-ADA | 22186 | 22187 |
| TRAK-3-LLE | 22158 | 22159 |
| TRAK-3-CFLJ | 22188 | 22189 |
| TRAK-3-LRE | 22156 | 22157 |

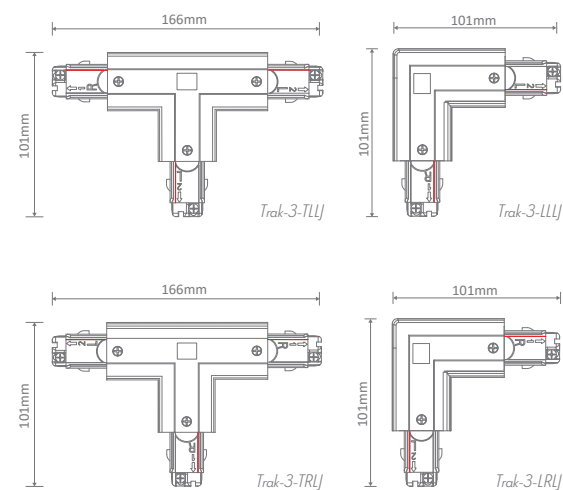

| Item No. | Variants | |
|---------------|----------|-------|
| | Blk | Wht |
| TRAK-3-TLLJ | 22176 | 22177 |
| TRAK-3-LLLJ | 22164 | 22165 |
| TRAK-3-TRLJ | 22178 | 22179 |
| TRAK-3-LRLJ | 22166 | 22167 |
| TRAK-3-ROD | 22182 | 22183 |
| TRAK-3-SUS | 22184 | 22185 |
| TRAK-3-SUS-3M | 22190 | 22191 |

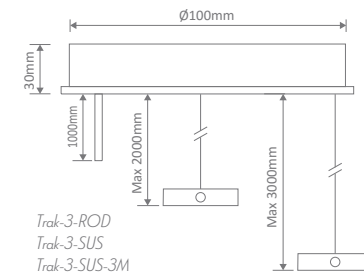



Allegra Series



- Adjustable length cord suspension.
- Part of a family of matching pendant, table lamp and floor lamp.

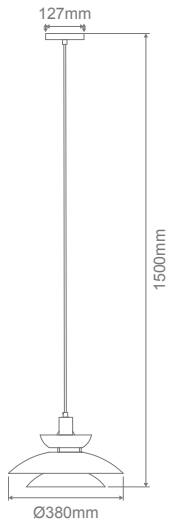

| Item No. | Variants | | | Wattage | Requires |
|-------------|----------|-------|-------|-------------|----------------------------|
| | Blk | Wht | Schr | | |
| ALLEGRA-PDT | 22701 | 22702 | 22703 | 25W LED Max | 1xE27 Globe (Not Included) |



Forge Series



- Adjustable length cord suspension.
- Part of a family of matching pendant, table lamp and floor lamp.



| Item No. | Variant | Wattage | Requires |
|----------|---------|---------|----------|
| | | | |

Strap Series



- Part of a family of matching pendant, table, floor lamp and wall light.
- Adjustable length cord suspension.



| Item No. | Variants | | Wattage | Requires |
|-----------|----------|-------|-------------|----------------------------|
| | Blk | Wht | | |
| STRAP-PDT | 22716 | 22717 | 25W LED Max | 1xE27 Globe (Not Included) |



Carter Series



- Modern thin paper rope shade design.
- Featuring Matt Black metalware, black cable with a choice of Black or Natural colour shade options.

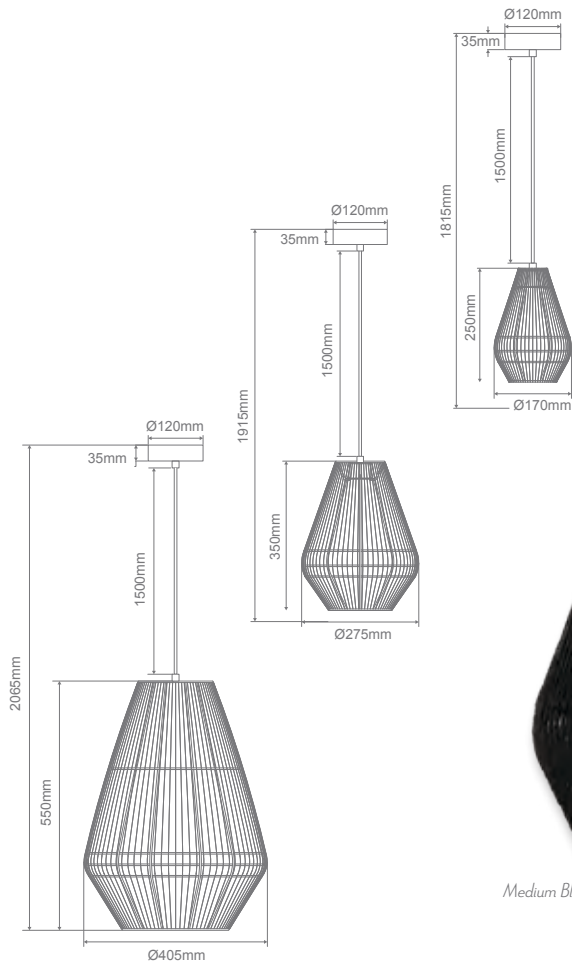

| Item No. | Variants | | Wattage | Requires |
|----------------|----------|-------|-------------|----------------------------|
| | Blk | Ntr | | |
| CARTER-PDT-SML | 23140 | 23141 | 25W LED Max | 1xE27 Globe (Not Included) |
| CARTER-PDT-MED | 23142 | 23143 | | |
| CARTER-PDT-LRG | 23144 | 23145 | | |



Pendants



Spin

- Fully dimmable with suitable dimmers.
- Adjustable length cord suspension.



| Item No. | Variants | | | CCT | Wattage | Lumen Output | | |
|-----------------|--------------|--------------|--------------|------|---------|------------------|---------------------|-------------|
| | Blk | Sbrs | Wht | | | Warm White 3000K | Neutral White 4000K | White 5700K |
| SPIN-PDT | 22726 | 22727 | 22728 | TRIO | 12W | 1320lm | 1320lm | 1320lm |



Pendants

Felix Series

- Adjustable length cord suspension.
- Natural Plywood wood finish.



| Item No. | Variant | Wattage | Requires |
|------------------|--------------|-------------|----------------------------|
| FELIX-PDT | 22765 | 25W LED Max | 1xE27 Globe (Not Included) |

Interior

Interior



Hoist Series

- Adjustable length cord suspension.

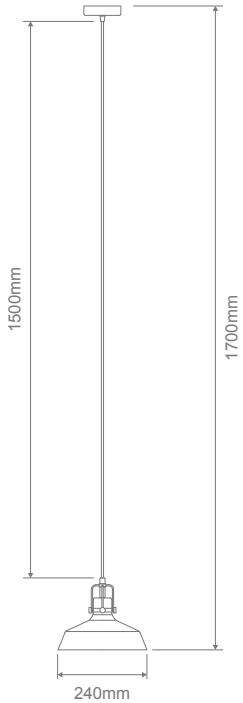

| Item No. | Variants | | | Wattage | Requires |
|------------------|--------------|--------------|--------------|-------------|----------------------------|
| | Blk/Clear | Sch/Smoke | Abr/Amber | | |
| HOIST-PDT | 22731 | 22732 | 22733 | 25W LED Max | 1xE27 Globe (Not Included) |



Bubble Series

- Adjustable length cord suspension.



1500mm Cable Length



Available Canopies

| Item No. | Variants | | | | | | | Wattage | Requires |
|-----------------------|--------------|--------------|--------------|--------------|--------------|--------------|--------------|-------------|----------------------------|
| | Blk | Wht | Chr | Schr | Rgld | Sbrs | Abrs | | |
| BUBBLE-200-CLR | 31450 | 31451 | 31452 | 31453 | 31454 | 31455 | 31456 | 25W LED Max | 1xE27 Globe (Not Included) |
| BUBBLE-250-CLR | 31464 | 31465 | 31466 | 31467 | 31468 | 31469 | 31470 | | |
| BUBBLE-300-CLR | 31478 | 31479 | 31480 | 31481 | 31482 | 31483 | 31484 | | |

| Item No. | Variants | | | | | | | Wattage | Requires |
|-----------------------|--------------|--------------|--------------|--------------|--------------|--------------|--------------|-------------|----------------------------|
| | Blk | Wht | Chr | Schr | Rgld | Sbrs | Abrs | | |
| BUBBLE-200-OPL | 31457 | 31458 | 31459 | 31460 | 31461 | 31462 | 31463 | 25W LED Max | 1xE27 Globe (Not Included) |
| BUBBLE-250-OPL | 31471 | 31472 | 31473 | 31474 | 31475 | 31476 | 31477 | | |
| BUBBLE-300-OPL | 31485 | 31486 | 31487 | 31488 | 31489 | 31490 | 31491 | | |



Flaunt Series

- Adjustable length cord suspension.

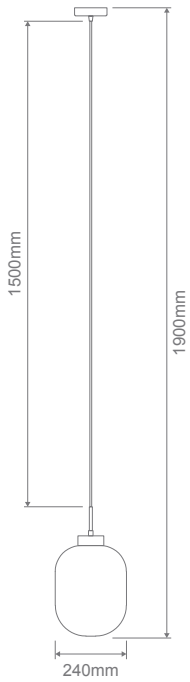

| Item No. | Variants | | | Wattage | Requires |
|------------|----------|-------|-------|-------------|----------------------------|
| | Smoke | Clear | Opal | | |
| FLAUNT-BLK | 22737 | 22738 | 22739 | 25W LED Max | 1xE27 Globe (Not Included) |
| FLAUNT-SBR | 22740 | 22741 | 22742 | | |
| FLAUNT-SCH | 22743 | 22744 | 22745 | | |



Sands

- Part of a family of matching pendant and table lamp.
- Adjustable length cord suspension.

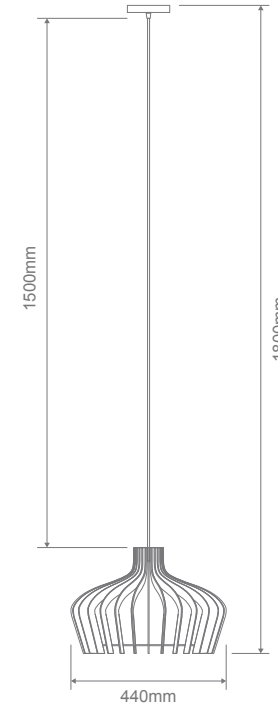

| Item No. | Variant | Wattage | Requires |
|-----------|---------|-------------|----------------------------|
| SANDS-PDT | 22749 | 25W LED Max | 1xE27 Globe (Not Included) |



Sail Series

- Adjustable length cord suspension.



| Item No. | Variants | | | Wattage | Requires |
|----------|-----------|-----------|-----------|-------------|----------------------------|
| | Blk/Clear | Sch/Smoke | Abr/Amber | | |
| SAIL-PDT | 22753 | 22754 | 22755 | 25W LED Max | 1xE27 Globe (Not Included) |



Eva Series

- Glass shade, antique brass glass holder.
- Adjustable length cord suspension.



Opal

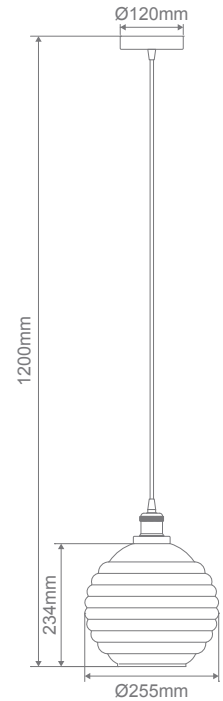

| Item No. | Variant | Wattage | Requires |
|----------|---------|---------|----------|
| | | | |



Pendants

Diana



- Glass shade, painted black metalware.
- Adjustable length chain suspension.

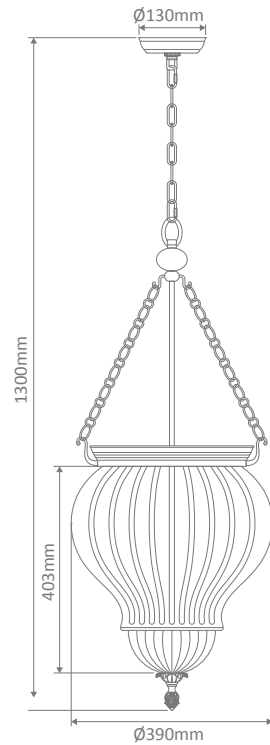

| Item No. | Variant | Wattage | Colour | Requires |
|----------|---------|---------------|--------|-----------------------------|
| DIANA | 31323 | 3x25W LED Max | Clear | 3xE14 Globes (Not Included) |



Pendants

Ashley



- Wire guard shade.
- Featuring plated / Matt black with Antique Brass highlights.
- Part of a family of matching pendant, table lamp, floor lamp and desk lamp.

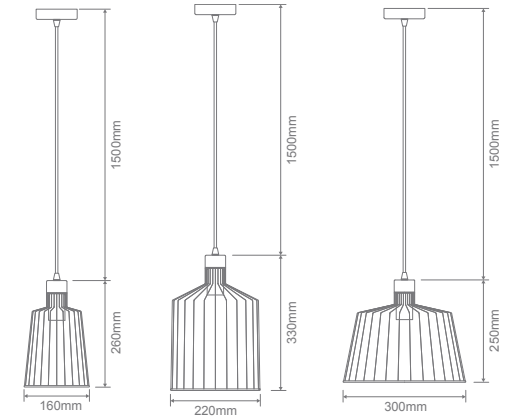

| Item No. | Variants | | | Wattage | Requires |
|------------|----------|--------|-------|-------------|----------------------------|
| | Small | Medium | Large | | |
| ASHLEY-PDT | 22508 | 22509 | 22510 | 25W LED Max | 1xE27 Globe (Not Included) |

Interior

Interior



Pendants

Evelyn Series



- Glass shade, antique brass glass holder.
- Adjustable length cord suspension.



| Item No. | Variants | | | Wattage | Requires |
|---------------|--------------|--------------|--------------|-------------|----------------------------|
| | Amber | Clear | Grey | | |
| EVELYN | 31350 | 31351 | 31352 | 25W LED Max | 1xE27 Globe (Not Included) |

EVELYN-GREY



Pendants



- Flicker Free Driver
- Dimmable
- Replacement Warranty (3yr)
- Voltage 240V
- 355° Rotation
- 45° Tilt

Moon Pendant Series

- SMD LED Chip.
- 6W/9W Power Switchable.
- 45° Tiltable, 355° Rotatable.
- Fully dimmable with suitable dimmers.
- Optional coloured baffles available for Tube or Spot Reflectors.
- CRI 90



MOON-PDT-SPOT



MOON-PDT-TUBE

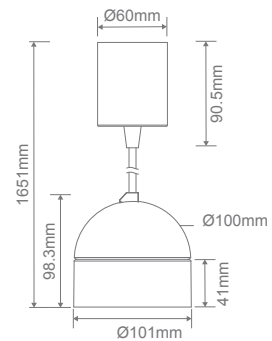
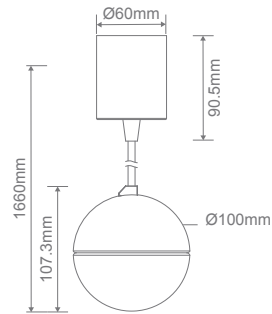

MOON-PDT-OPAL



MOON-PDT-FLD

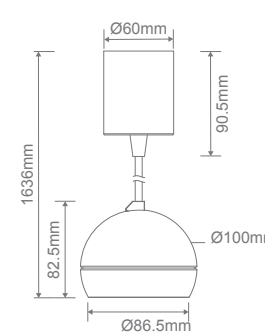
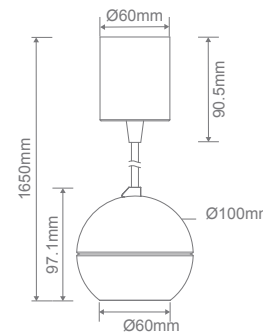

Up to 45° tilt,
355° Rotation



Pendants



- Flicker Free Driver
- Dimmable
- Replacement Warranty (3yr)
- Voltage 240V
- 355° Rotation
- 45° Tilt

Interior

| Item No. | Variants | | Wattage | IP | CCT | |
|----------|----------|-------|---------|------|-----|------|
| | Blk | Wht | | | | |
| MOON-PDT | FLD | 22772 | 22773 | 6/9W | 20 | TRIO |
| | OPAL | 22774 | 22775 | | | |
| | SPOT | 22776 | 22777 | | | |
| | TUBE | 22778 | 22779 | | | |

| 6W - Lumen Output | | | | | | | | | | | |
|-------------------|-----------|----------|----------|---------------------|-----------|----------|----------|-------------|-----------|----------|----------|
| Warm White 3000K | | | | Neutral White 4000K | | | | White 5700K | | | |
| Fld-60° | Opal-130° | Spot-30° | Tube-60° | Fld-60° | Opal-130° | Spot-30° | Tube-60° | Fld-60° | Opal-130° | Spot-30° | Tube-60° |
| 477lm | 433lm | 498lm | 430lm | 556lm | 504lm | 534lm | 504lm | 561lm | 513lm | 536lm | 515lm |

| 9W - Lumen Output | | | | | | | | | | | |
|-------------------|-----------|----------|----------|---------------------|-----------|----------|----------|-------------|-----------|----------|----------|
| Warm White 3000K | | | | Neutral White 4000K | | | | White 5700K | | | |
| Fld-60° | Opal-130° | Spot-30° | Tube-60° | Fld-60° | Opal-130° | Spot-30° | Tube-60° | Fld-60° | Opal-130° | Spot-30° | Tube-60° |
| 651lm | 600lm | 661lm | 593lm | 780lm | 719lm | 756lm | 716lm | 775lm | 729lm | 751lm | 708lm |



Pendants

Luna Series



- Coloured metal shade with painted white interior.
- Adjustable length cord suspension.

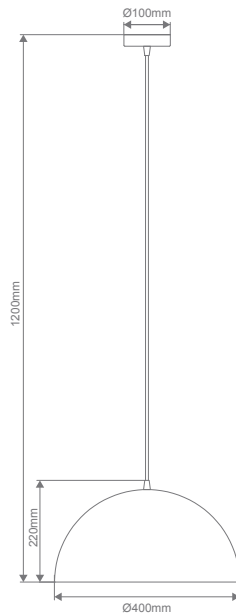

LUNA-400-BLK

| Item No. | Variants | | Wattage | Requires |
|----------|----------|-------|-------------|----------------------------|
| | Black | White | | |
| LUNA-400 | 31366 | 31367 | 25W LED Max | 1xE27 Globe (Not Included) |



Zoey Series



- Coloured metal shade with painted white interior.
- Adjustable length cord suspension.
- Matching small and large shade option.



| Item No. | Variants | | Wattage | Requires |
|----------|----------|-------|-------------|----------------------------|
| | Black | White | | |
| ZOXY-260 | 31377 | 31378 | 25W LED Max | 1xE27 Globe (Not Included) |
| ZOXY-400 | 31382 | 31383 | 25W LED Max | 1xE27 Globe (Not Included) |



Ruby Series



- Coloured metal shade with painted white interior.
- Adjustable length cord suspension.



| Item No. | Variants | | Wattage | Requires |
|----------|----------|-------|-------------|----------------------------|
| | Black | White | | |
| RUBY-185 | 31395 | 31396 | 25W LED Max | 1xE27 Globe (Not Included) |



Jade-220 Series



- Coloured metal shade with painted white interior.
- Adjustable length cord suspension.
- Matching small and large shade option.

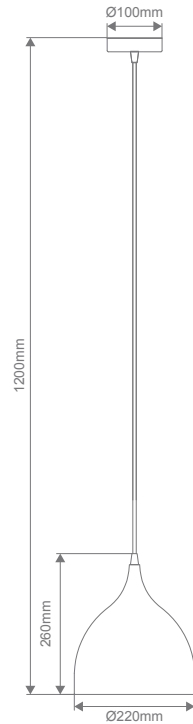

| Item No. | Variants | | Wattage | Requires |
|----------|----------|-------|-------------|----------------------------|
| | Black | White | | |
| JADE-220 | 31415 | 31416 | 25W LED Max | 1xE27 Globe (Not Included) |



JADE-220-BLK



Jade-240 Series

- Coloured metal shade with painted white interior.
- Adjustable length cord suspension.
- Matching small and large shade option.

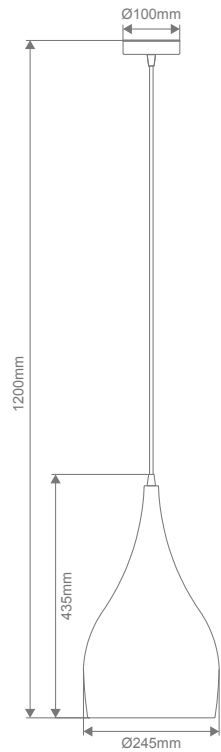

| Item No. | Variants | | Wattage | Requires |
|----------|----------|-------|-------------|----------------------------|
| | Black | White | | |
| JADE-240 | 31420 | 31421 | 25W LED Max | 1xE27 Globe (Not Included) |

JADE-240-WHT



Melody Series

- Coloured metal shade with painted white interior.
- Adjustable length cord suspension.

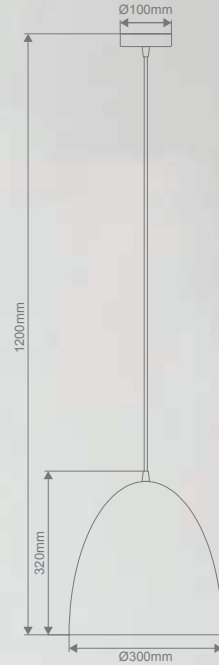

| Item No. | Variants | | Wattage | Requires |
|------------|----------|-------|-------------|----------------------------|
| | Black | White | | |
| MELODY-300 | 31443 | 31444 | 25W LED Max | 1xE27 Globe (Not Included) |





Pendants

Nova Series



- Coloured metal shade with painted white interior.
- Adjustable length cord suspension.

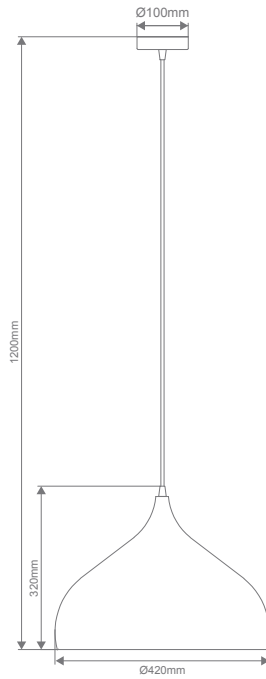

| Item No. | Variants | | Wattage | Requires |
|----------|----------|-------|-------------|----------------------------|
| | Black | White | | |
| NOVA-420 | 31433 | 31434 | 25W LED Max | 1xE27 Globe (Not Included) |



NOVA-420-BLK

Interior



LED Linear Pendants



Max-35 Series

- Fully dimmable with suitable dimmers.
- Aluminium profile and PMMA opal diffuser.
- Adjustable length wire suspension.
- Removable Honeycomb Reflector.



Black



| Item No. | Variants | | Wattage | IP Rating | CCT | Lumen Output (Standard / Honeycomb) | | |
|-------------|----------|-------|---------|-----------|------|-------------------------------------|---------------------|---------------|
| | Blk | Wht | | | | Warm White 3000K | Neutral White 4000K | White 5700K |
| MAX-35-1.2M | 22648 | 22649 | 30W | 20 | TRIO | 2800lm/1050lm | 3000m/1200lm | 3050lm/1400lm |
| MAX-35-1.7M | 22651 | 22652 | 40W | 20 | TRIO | 3500lm/1500lm | 3700lm/1700lm | 3750lm/1900lm |



Maxi-40 Flat Series



- Profile includes Driver and PLEX-COB-20W LED Strip.
- Aluminium profile and diffuser.
- Inbuilt LED Driver.
- Adjustable length 3m wire suspension.
- Complete with 3m clear power cable.
- Made to order in Australia from local and imported components.
- DALI Options available upon request.
- Black and Clear diffuser options available upon request.
- CRI90
- IP20 Indoor Use Only.

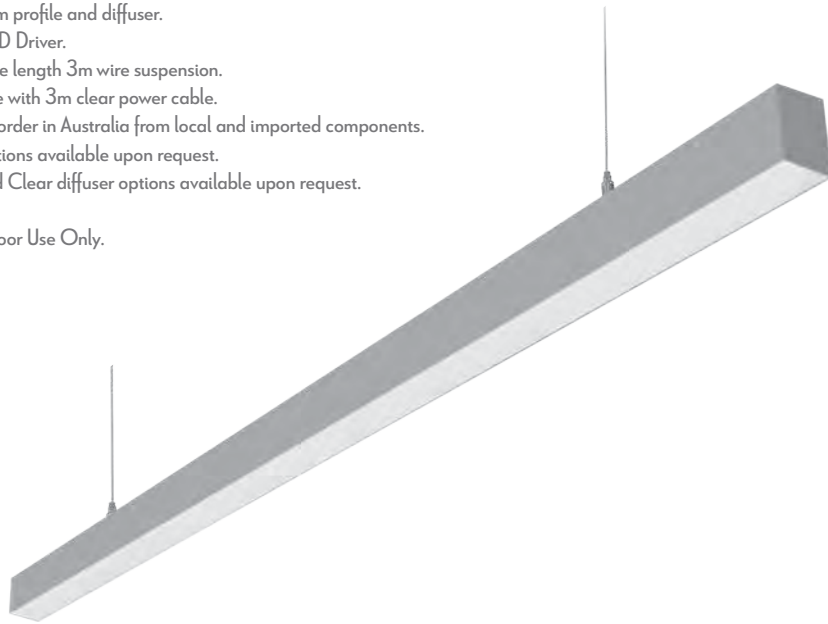

MAXI-40-FD-BLK MAXI-40-FD-WHT

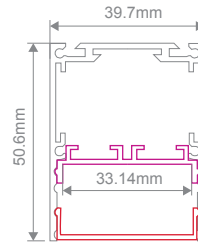

| Item No. | Variants | | | Wattage | Diffuser | CCT | Lumen Output |
|-----------------|----------|-------|-------|---------|-----------|-------|--------------|
| | Blk | Wht | Alu | | | | |
| MAXI-40-1.2M-FD | 30135 | 30140 | 30130 | 24W | Prismatic | 3000K | 2160lm |
| | 30136 | 30141 | 30131 | | Frosted | | |
| | 30150 | 30156 | 30145 | | Prismatic | 4000K | |
| | 30151 | 30157 | 30146 | | Frosted | | |
| MAXI-40-1.7M-FD | 30225 | 30230 | 30220 | 34W | Prismatic | 3000K | 3060lm |
| | 30226 | 30231 | 30221 | | Frosted | | |
| | 30240 | 30245 | 30235 | | Prismatic | 4000K | |
| | 30241 | 30246 | 30236 | | Frosted | | |
| MAXI-40-2.4M-FD | 30315 | 30320 | 30310 | 48W | Prismatic | 3000K | 4320lm |
| | 30316 | 30321 | 30311 | | Frosted | | |
| | 30330 | 30335 | 30325 | | Prismatic | 4000K | |
| | 30331 | 30336 | 30326 | | Frosted | | |



Maxi-40 Low Series



- Profile includes Driver and PLEX-COB-20W LED Strip.
- Aluminium profile and diffuser.
- Inbuilt LED Driver.
- Adjustable length 3m wire suspension.
- Complete with 3m clear power cable.
- Made to order in Australia from local and imported components.
- DALI Options available upon request.
- Black and Clear diffuser options available upon request.
- CRI90
- IP20 Indoor Use Only.

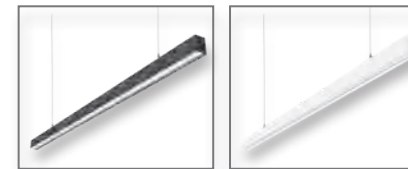
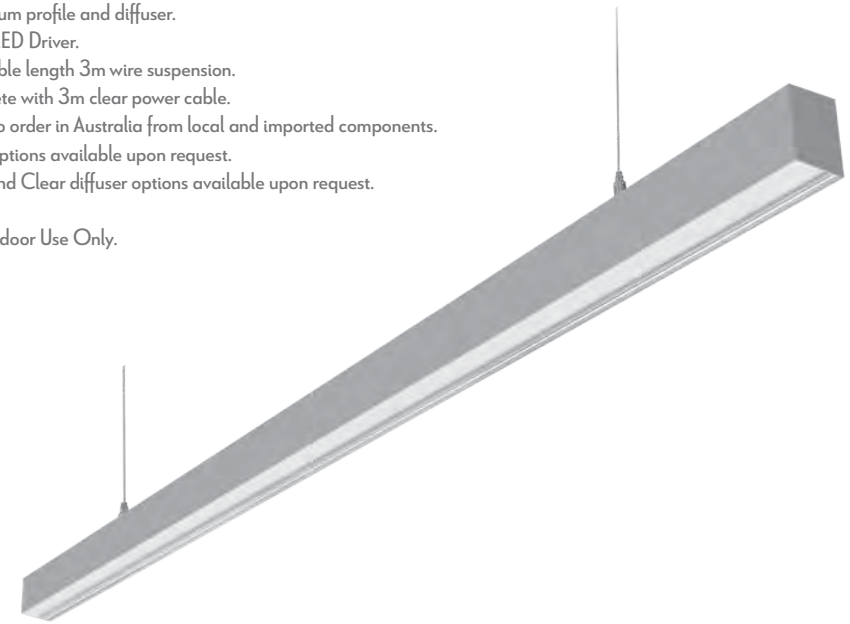

MAXI-40-LD-BLK MAXI-40-LD-WHT

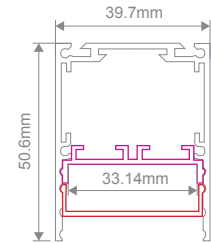

| Item No. | Variants | | | Wattage | Diffuser | CCT | Lumen Output |
|-----------------|----------|-------|-------|---------|-----------|-------|--------------|
| | Blk | Wht | Alu | | | | |
| MAXI-40-1.2M-LD | 30105 | 30110 | 30100 | 24W | Prismatic | 3000K | 2160lm |
| | 30106 | 30111 | 30101 | | Frosted | | |
| | 30120 | 30125 | 30115 | | Prismatic | 4000K | |
| | 30121 | 30126 | 30116 | | Frosted | | |
| MAXI-40-1.7M-LD | 30195 | 30200 | 30190 | 34W | Prismatic | 3000K | 3060lm |
| | 30196 | 30201 | 30191 | | Frosted | | |
| | 30210 | 30215 | 30205 | | Prismatic | 4000K | |
| | 30211 | 30216 | 30206 | | Frosted | | |
| MAXI-40-2.4M-LD | 30285 | 30290 | 30280 | 48W | Prismatic | 3000K | 4320lm |
| | 30286 | 30291 | 30281 | | Frosted | | |
| | 30300 | 30305 | 30295 | | Prismatic | 4000K | |
| | 30301 | 30306 | 30296 | | Frosted | | |



Maxi-40 High Series



- Profile includes Driver and PLEX-COB-20W LED Strip.
- Aluminium profile and diffuser.
- Inbuilt LED Driver.
- Adjustable length 3m wire suspension.
- Complete with 3m clear power cable.
- Made to order in Australia from local and imported components.
- DALI Options available upon request.
- Black and Clear diffuser options available upon request.
- CRI90
- IP20 Indoor Use Only.

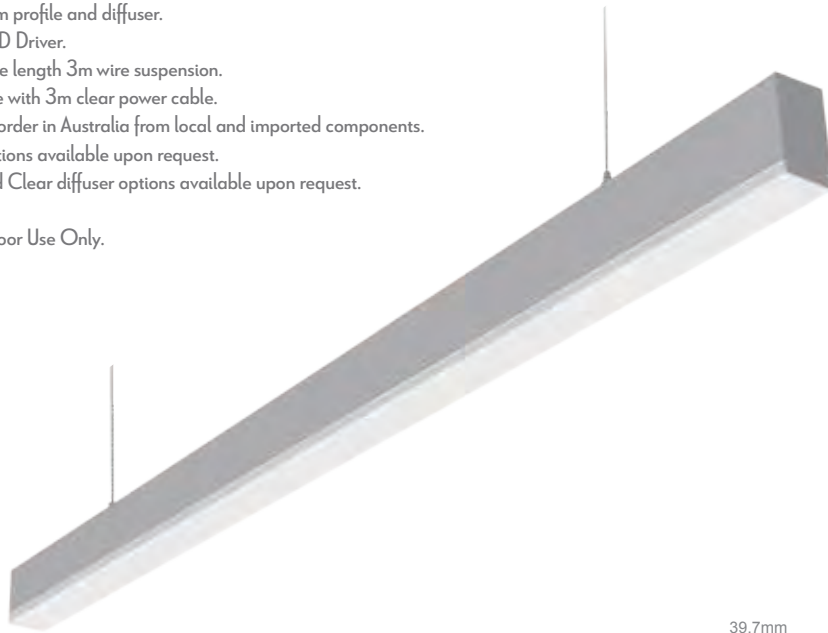

MAXI-40-HD-BLK

MAXI-40-HD-WHT

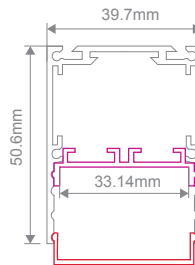

Maxi-50 1.2M Series



- Profile includes Driver and PLEX-COB-20W LED Strip.
- Aluminium profile and diffuser.
- Inbuilt LED Driver.
- Adjustable length 3m wire suspension.
- Complete with 3m clear power cable.
- Made to order in Australia from local and imported components.
- DALI Options available upon request.
- CRI90
- IP20 Indoor Use Only.

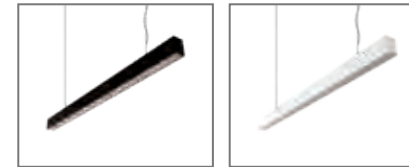
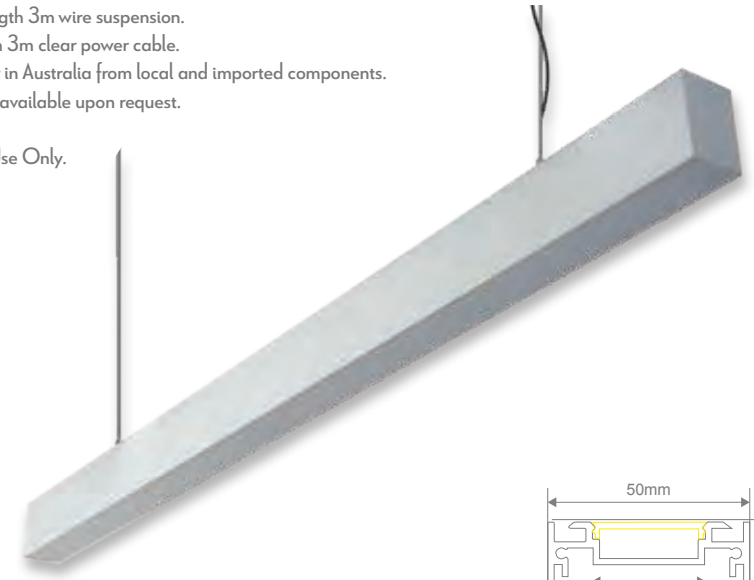

MAXI-50-DN-BLK

MAXI-50-DN-WHT

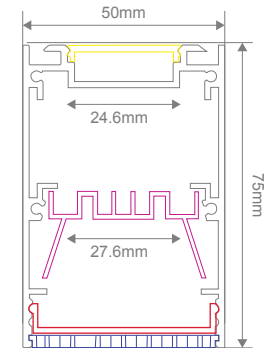

| Item No. | Variants | | | Wattage | Diffuser | CCT | Lumen Output |
|-----------------|----------|-------|-------|---------|-----------|-------|--------------|
| | Blk | Wht | Alu | | | | |
| MAXI-40-1.2M-HD | 30165 | 30170 | 30160 | 24W | Prismatic | 3000K | 2160lm |
| | 30166 | 30171 | 30161 | | Frosted | | |
| | 30180 | 30185 | 30175 | | Prismatic | | |
| | 30181 | 30186 | 30176 | | Frosted | | |
| MAXI-40-1.7M-HD | 30255 | 30260 | 30250 | 34W | Prismatic | 3000K | 3060lm |
| | 30256 | 30261 | 30251 | | Frosted | | |
| | 30270 | 30275 | 30265 | | Prismatic | | |
| | 30271 | 30276 | 30266 | | Frosted | | |
| MAXI-40-2.4M-HD | 30345 | 30350 | 30340 | 48W | Prismatic | 3000K | 4320lm |
| | 30346 | 30351 | 30341 | | Frosted | | |
| | 30360 | 30365 | 30355 | | Prismatic | | |
| | 30361 | 30366 | 30356 | | Frosted | | |

| Item No. | Variants | | | Wattage | Diffuser | CCT | Lumen Output |
|--------------|----------|-------|-------|---------|-----------|-------|--------------|
| | Blk | Wht | Alu | | | | |
| MAXI-50-1.2M | 30503 | 30510 | 30496 | 24W | Prismatic | 3000K | 2160lm |
| | 30504 | 30511 | 30497 | | Frosted | | |
| | 30505 | 30512 | 30498 | | Honeycomb | | |
| | 30506 | 30513 | 30499 | | Opal | | |
| | 30507 | 30514 | 30500 | | Black | | |
| | 30508 | 30515 | 30501 | | Clear | | |
| MAXI-50-1.2M | 30524 | 30531 | 30517 | 24W | Frosted | 4000K | 2400lm |
| | 30525 | 30532 | 30518 | | Prismatic | | |
| | 30526 | 30533 | 30519 | | Honeycomb | | |
| | 30527 | 30534 | 30520 | | Opal | | |
| | 30528 | 30535 | 30521 | | Black | | |
| | 30529 | 30536 | 30522 | | Clear | | |



Maxi-50 1.7M Series



- Profile includes Driver and PLEX-COB-20W LED Strip.
- Aluminium profile and diffuser.
- Inbuilt LED Driver.
- Adjustable length 3m wire suspension.
- Complete with 3m clear power cable.
- Made to order in Australia from local and imported components.
- DALI Options available upon request.
- CRI90
- IP20 Indoor Use Only.

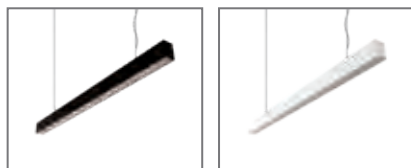
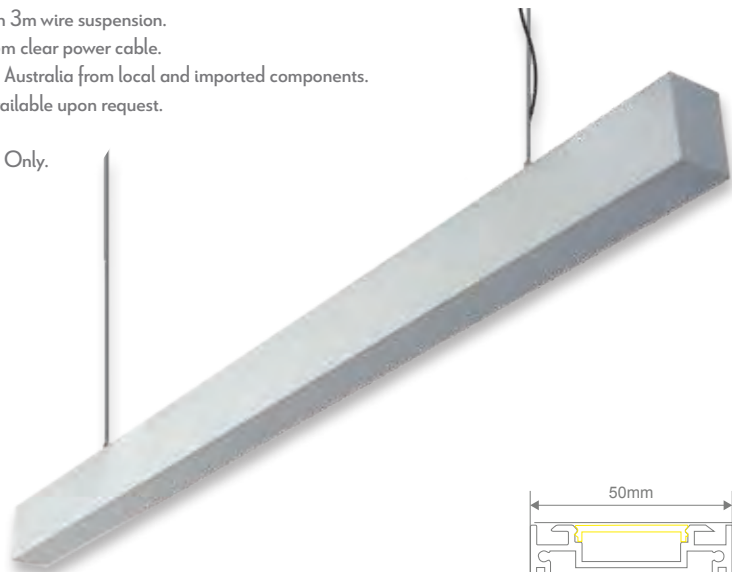

MAXI-50-DN-BLK MAXI-50-DN-WHT

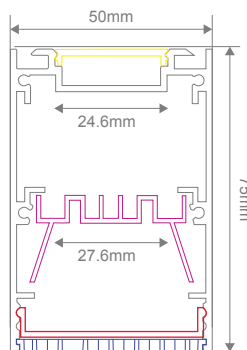

Maxi-50 2.4M Series



- Profile includes Driver and PLEX-COB-20W LED Strip.
- Aluminium profile and diffuser.
- Inbuilt LED Driver.
- Adjustable length 3m wire suspension.
- Complete with 3m clear power cable.
- Made to order in Australia from local and imported components.
- DALI Options available upon request.
- CRI90
- IP20 Indoor Use Only.

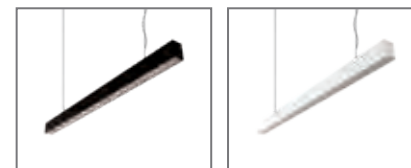
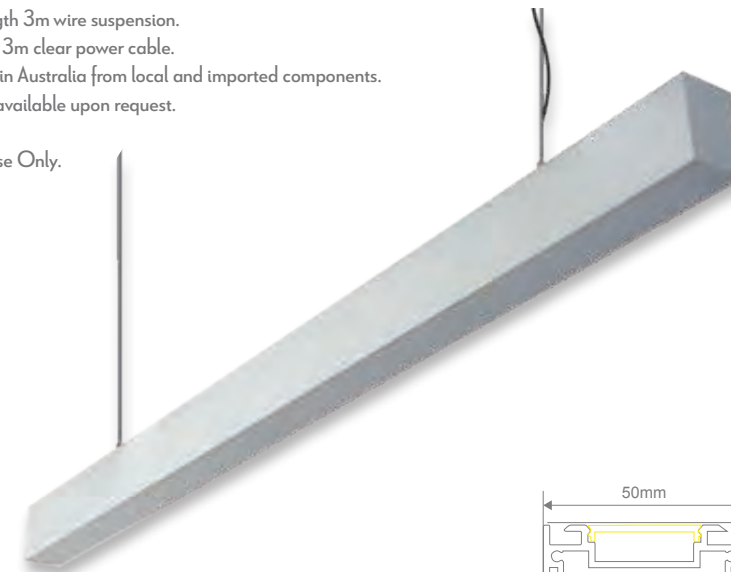

MAXI-50-DN-BLK MAXI-50-DN-WHT

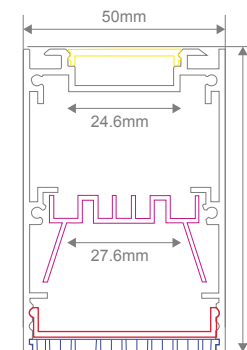

| Item No. | Variants | | | Wattage | Diffuser | CCT | Lumen Output |
|--------------|----------|-------|-------|---------|-----------|-------|--------------|
| | Blk | Wht | Alu | | | | |
| MAXI-50-1.7M | 30545 | 30552 | 30538 | 34W | Prismatic | 3000K | 3060lm |
| | 30546 | 30553 | 30539 | | Frosted | | |
| | 30547 | 30554 | 30540 | | Honeycomb | | |
| | 30548 | 30555 | 30541 | | Opal | | |
| | 30549 | 30556 | 30542 | | Black | | |
| | 30550 | 30557 | 30543 | | Clear | | |
| MAXI-50-1.7M | 30566 | 30573 | 30559 | 34W | Frosted | 4000K | 3400lm |
| | 30567 | 30574 | 30560 | | Prismatic | | |
| | 30568 | 30575 | 30561 | | Honeycomb | | |
| | 30569 | 30576 | 30562 | | Opal | | |
| | 30570 | 30577 | 30563 | | Black | | |
| | 30571 | 30578 | 30564 | | Clear | | |

| Item No. | Variants | | | Wattage | Diffuser | CCT | Lumen Output |
|--------------|----------|-------|-------|---------|-----------|-------|--------------|
| | Blk | Wht | Alu | | | | |
| MAXI-50-2.4M | 30587 | 30594 | 30580 | 48W | Prismatic | 3000K | 4320lm |
| | 30588 | 30595 | 30581 | | Frosted | | |
| | 30589 | 30596 | 30582 | | Honeycomb | | |
| | 30590 | 30597 | 30583 | | Opal | | |
| | 30591 | 30598 | 30584 | | Black | | |
| | 30592 | 30599 | 30585 | | Clear | | |
| MAXI-50-2.4M | 30608 | 30615 | 30601 | 48W | Frosted | 4000K | 4800lm |
| | 30609 | 30616 | 30602 | | Prismatic | | |
| | 30610 | 30617 | 30603 | | Honeycomb | | |
| | 30611 | 30618 | 30604 | | Opal | | |
| | 30612 | 30619 | 30605 | | Black | | |
| | 30613 | 30620 | 30606 | | Clear | | |



Maxi-Curve 1.2M Series



- Profile includes Driver and PLEX-COB-20W LED Strip.
- Aluminium profile and diffuser.
- Inbuilt LED Driver.
- Adjustable length 3m wire suspension.
- Complete with 3m clear power cable.
- Made to order in Australia from local and imported components.
- DALI Options available upon request.
- CRI90
- IP20 Indoor Use Only.



MAXI-CURVE-DN-BLK

MAXI-CURVE-DN-WHT

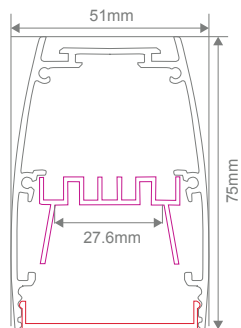

| Item No. | Variants | | | Wattage | Diffuser | CCT | Lumen Output |
|-----------------|----------|-------|-------|---------|-----------|-------|--------------|
| | Blk | Wht | Alu | | | | |
| MAXI-CURVE-1.2M | 30377 | 30384 | 30370 | 24W | Prismatic | 3000K | 2160lm |
| | 30378 | 30385 | 30371 | | Frosted | | |
| | 30379 | 30386 | 30372 | | Honeycomb | | |
| | 30380 | 30387 | 30373 | | Opal | | |
| | 30381 | 30388 | 30374 | | Black | | |
| | 30382 | 30389 | 30375 | | Clear | | |
| MAXI-CURVE-1.2M | 30398 | 30404 | 30391 | 24W | Frosted | 4000K | 2400lm |
| | 30399 | 30405 | 30392 | | Prismatic | | |
| | 30400 | 30406 | 30393 | | Honeycomb | | |
| | 30401 | 30407 | 30394 | | Opal | | |
| | 30402 | 30408 | 30395 | | Black | | |
| | 30403 | 30409 | 30396 | | Clear | | |



Maxi-Curve 1.7M Series



- Profile includes Driver and PLEX-COB-20W LED Strip.
- Aluminium profile and diffuser.
- Inbuilt LED Driver.
- Adjustable length 3m wire suspension.
- Complete with 3m clear power cable.
- Made to order in Australia from local and imported components.
- DALI Options available upon request.
- CRI90
- IP20 Indoor Use Only.



MAXI-CURVE-DN-BLK

MAXI-CURVE-DN-WHT

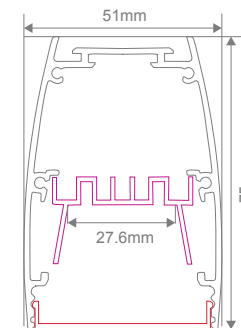

| Item No. | Variants | | | Wattage | Diffuser | CCT | Lumen Output |
|-----------------|----------|-------|-------|---------|-----------|-------|--------------|
| | Blk | Wht | Alu | | | | |
| MAXI-CURVE-1.7M | 30419 | 30426 | 30412 | 34W | Prismatic | 3000K | 3060lm |
| | 30420 | 30427 | 30413 | | Frosted | | |
| | 30421 | 30428 | 30414 | | Honeycomb | | |
| | 30422 | 30429 | 30415 | | Opal | | |
| | 30423 | 30430 | 30416 | | Black | | |
| | 30424 | 30431 | 30417 | | Clear | | |
| MAXI-CURVE-1.7M | 30440 | 30447 | 30433 | 34W | Frosted | 4000K | 3400lm |
| | 30441 | 30448 | 30434 | | Prismatic | | |
| | 30442 | 30449 | 30435 | | Honeycomb | | |
| | 30443 | 30450 | 30436 | | Opal | | |
| | 30444 | 30451 | 30437 | | Black | | |
| | 30445 | 30452 | 30438 | | Clear | | |



Maxi-Curve 2.4M Series



- Profile includes Driver and PLEX-COB-20W LED Strip.
- Aluminium profile and diffuser.
- Inbuilt LED Driver.
- Adjustable length 3m wire suspension.
- Complete with 3m clear power cable.
- Made to order in Australia from local and imported components.
- DALI Options available upon request.
- CRI90
- IP20 Indoor Use Only.



MAXI-CURVE-DN-BLK



MAXI-CURVE-DN-WHT

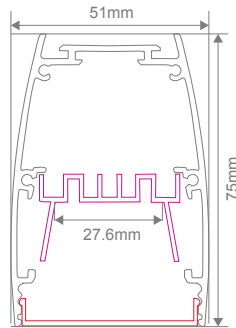

| Item No. | Variants | | | Wattage | Diffuser | CCT | Lumen Output |
|-----------------|----------|-------|-------|---------|-----------|-------|--------------|
| | Blk | Wht | Alu | | | | |
| MAXI-CURVE-2.4M | 30461 | 30468 | 30454 | 48W | Prismatic | 3000K | 4320lm |
| | 30462 | 30469 | 30455 | | Frosted | | |
| | 30463 | 30470 | 30456 | | Honeycomb | | |
| | 30464 | 30471 | 30457 | | Opal | | |
| | 30465 | 30472 | 30458 | | Black | | |
| | 30466 | 30473 | 30459 | | Clear | | |
| MAXI-CURVE-2.4M | 30482 | 30489 | 30475 | 48W | Frosted | 4000K | 4800lm |
| | 30483 | 30490 | 30476 | | Prismatic | | |
| | 30484 | 30491 | 30477 | | Honeycomb | | |
| | 30485 | 30492 | 30478 | | Opal | | |
| | 30486 | 30493 | 30479 | | Black | | |
| | 30487 | 30494 | 30480 | | Clear | | |



Strap Series



- Part of a family of matching pendant, table, floor lamp and wall light.

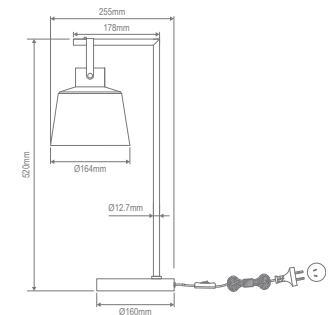

| Item No. | Variants | | Wattage | Requires |
|----------|----------|-------|-------------|----------------------------|
| | Blk | Wht | | |
| STRAP-TL | 22720 | 22721 | 25W LED Max | 1xE27 Globe (Not Included) |



Allegra Series



- Part of a family of matching pendant, table and floor lamp.

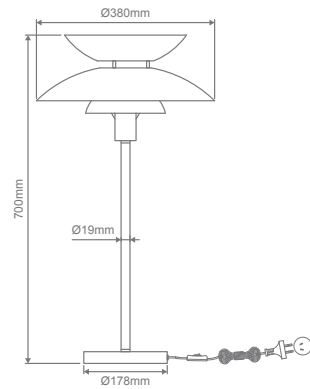

| Item No. | Variants | | | Wattage | Requires |
|------------|----------|-------|-------|-------------|----------------------------|
| | Blk | Wht | Schr | | |
| ALLEGRA-TL | 22704 | 22705 | 22706 | 25W LED Max | 1xE27 Globe (Not Included) |



Forge



- Part of a family of matching pendant, table lamp and floor lamp.

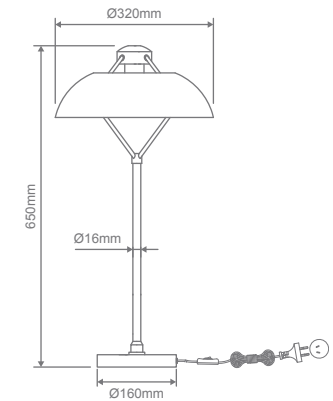

| Item No. | Variants | Wattage | Requires |
|----------|----------|---------|----------|
| | | | |



Sands



- Part of a family of matching pendant and table lamp.
- Natural Plywood wood finish.

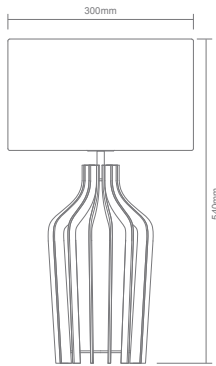

| Item No. | Variant | Wattage | Requires |
|----------|---------|-------------|----------------------------|
| SANDS-TL | 22750 | 25W LED Max | 1xE27 Globe (Not Included) |



Ashley Series



- Part of a family of matching pendant, table lamp, floor lamp and desk lamp.
- Matt Black plated with Antique Brass highlights and a black cloth shade.
- Available in three sizes.



Small



Medium



Large

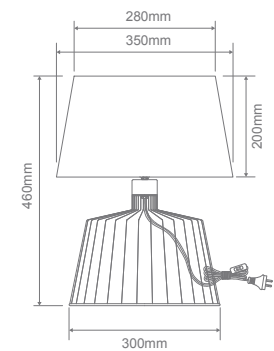
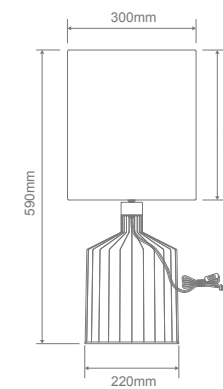
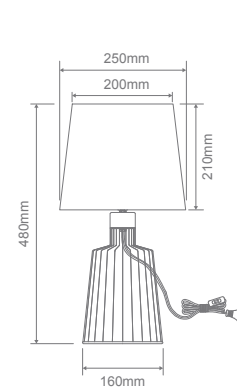

| Item No. | Variants | | | Wattage | Requires |
|-----------|----------|--------|-------|-------------|----------------------------|
| | Small | Medium | Large | | |
| ASHLEY-TL | 22512 | 22513 | 22514 | 25W LED Max | 1xE27 Globe (Not Included) |



Giana Series



- Square tube base with linen fabric shade.
- Includes 2A USB port.
- Available in the choice of Satin Brass metalware with a black shade, or Satin Chrome metalware with a white shade.



GIANA-TL-SCHR

GIANA-TL-SBRS

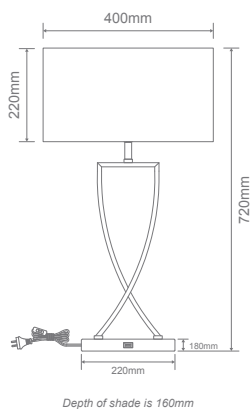

| Item No. | Variants | | Wattage | Requires |
|----------|-------------|--------------|-------------|----------------------------|
| | Satin Brass | Satin Chrome | | |
| GIANA-TL | 22542 | 22543 | 25W LED Max | 1xE27 Globe (Not Included) |



Sandra Series



- Available Antique Brass or Satin Chrome base complete with a cylindrical white linen fabric shade.



SANDRA-TL-SCHR

SANDRA-TL-ABR

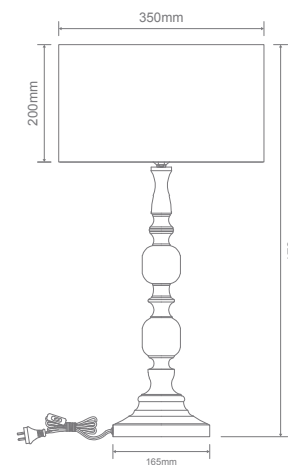

| Item No. | Variants | | Wattage | Requires |
|-----------|---------------|--------------|-------------|----------------------------|
| | Antique Brass | Satin Chrome | | |
| SANDRA-TL | 22545 | 22546 | 25W LED Max | 1xE27 Globe (Not Included) |



Carter Series



- Modern thin paper rope shade design.
- Featuring a choice of Black base with Black shade or Natural base with White shade options.

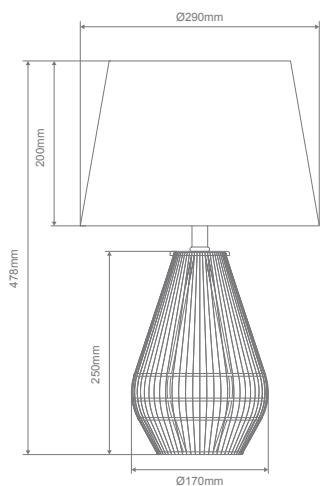

| Item No. | Variants | | Wattage | Requires |
|-----------|----------|-------|-------------|----------------------------|
| | Blk | Ntr | | |
| CARTER-TL | 23146 | 23147 | 25W LED Max | 1xE27 Globe (Not Included) |



Ashley



- Metal base, thin frame and wire guard shade.
- Featuring plated Matt Black with Antique Brass highlights.
- Part of a family of matching pendant, table lamp, floor lamp and desk lamp.

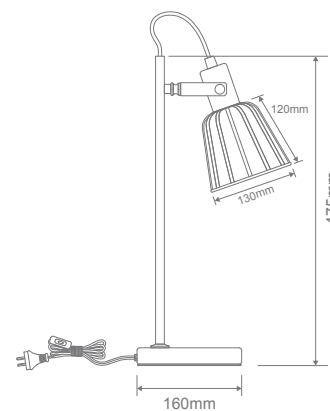

| Item No. | Variant | Wattage | Requires |
|-----------|---------|-------------|----------------------------|
| ASHLEY-DL | 22516 | 25W LED Max | 1xE14 Globe (Not Included) |



Leah Series



- Metal base, thin metal frame and a traditional conical shade.
- Available Matt White and Matt Black with Antique Brass highlights.
- Part of a family of matching desk lamp and floor lamp.

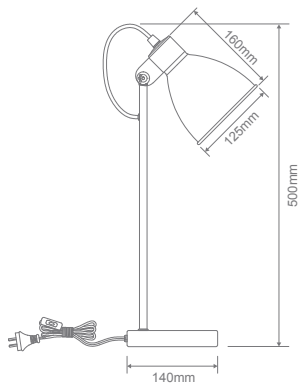

| Item No. | Variants | | Wattage | Requires |
|----------|----------|-------|-------------|----------------------------|
| | Blk | Wht | | |
| LEAH-DL | 22536 | 22537 | 25W LED Max | 1xE27 Globe (Not Included) |



Marisol



- White marble base, thin frame and metal cylindrical shade.
- Featuring plated Antique Brass and painted Black Shade.
- Part of a family of matching desk lamp and floor lamp.

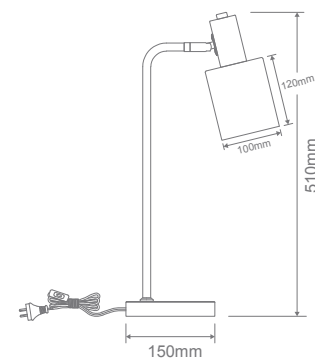

| Item No. | Variants | Wattage | Requires |
|----------|----------|---------|----------|
| | | | |



Rustica



- Metal base, thin frame and a wire mesh shade.
- Featuring plated Matt Black with Antique Brass highlights.
- Part of a family of matching desk lamp and floor lamp.

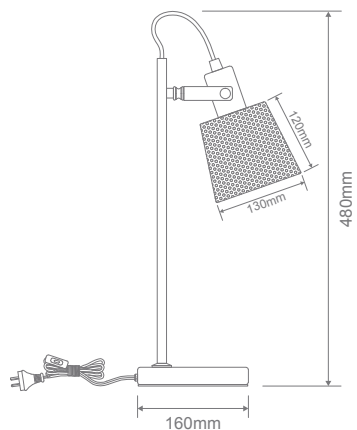

| Item No. | Variant | Wattage | Requires |
|------------|---------|-------------|----------------------------|
| RUSTICA-DL | 22519 | 25W LED Max | 1xE14 Globe (Not Included) |



Tinley Series



- Slim metal tube design and an adjustable knuckle holding a stylish dome shade.
- Available in Antique Chrome, Antique Brass and Antique Copper.
- Part of a family of matching table lamp, and floor lamp.



Antique Brass

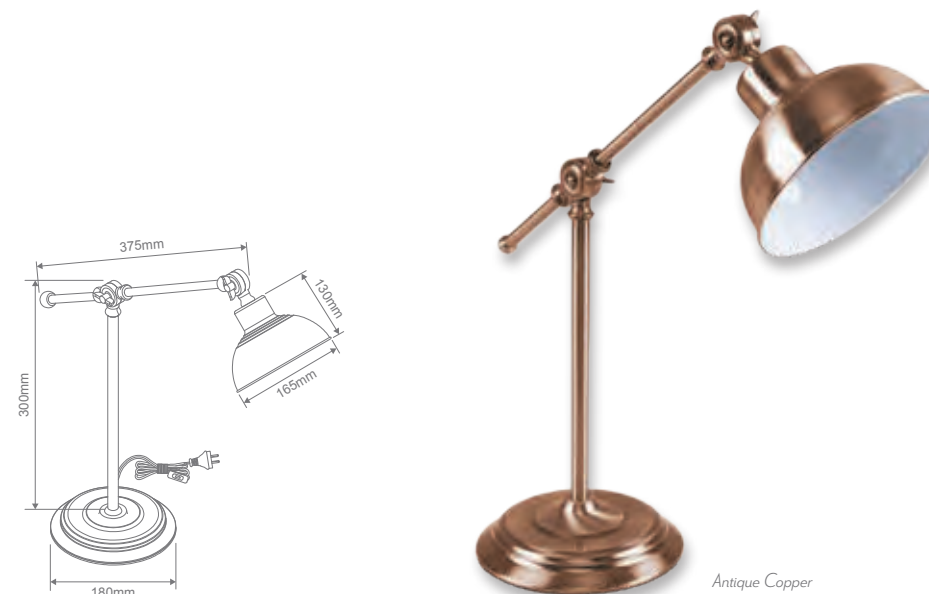

Antique Copper

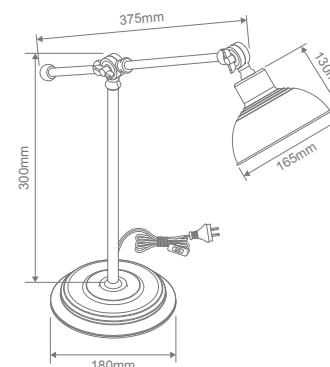

| Item No. | Variants | | | Wattage | Requires |
|-----------|----------|-------|-------|-------------|----------------------------|
| | A/BrS | A/Chr | A/Cop | | |
| TINLEY-DL | 22525 | 22526 | 22527 | 25W LED Max | 1xE27 Globe (Not Included) |



Carter Series



- Modern thin paper rope shade design.
- Featuring Matt Black metalware with a choice of Black or Natural colour shade options.

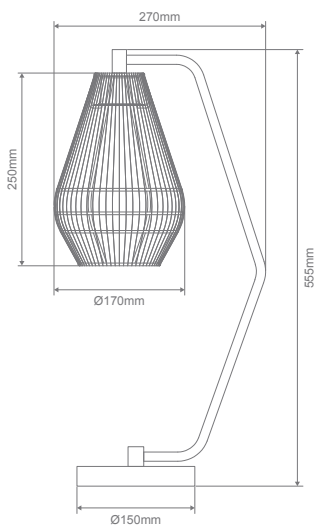

| Item No. | Variants | | Wattage | Requires |
|-----------|----------|-------|-------------|----------------------------|
| | Blk | Ntr | | |
| CARTER-DL | 23148 | 23149 | 25W LED Max | 1xE27 Globe (Not Included) |



Strap Series



- Part of a family of matching pendant, table, floor lamp and wall light.

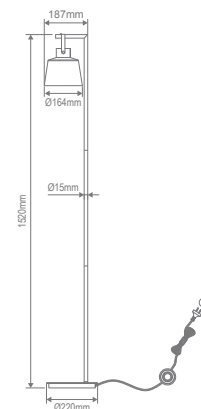
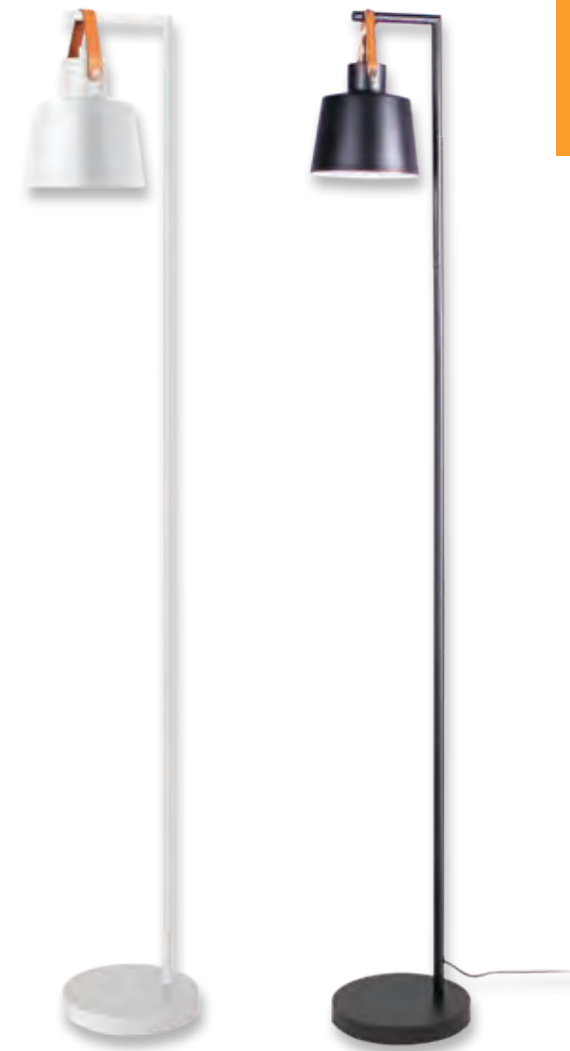

| Item No. | Variants | | Wattage | Requires |
|----------|----------|-------|-------------|----------------------------|
| | Blk | Wht | | |
| STRAP-FL | 22718 | 22719 | 25W LED Max | 1xE27 Globe (Not Included) |



Allegra Series



- Part of a family of matching pendant, table lamp and floor lamp.

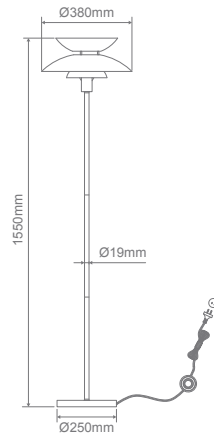

| Item No. | Variants | | | Wattage | Requires |
|------------------|----------|-------|-------------|----------------------------|----------|
| | Blk | Wht | Schr | | |
| ALLEGRA-FL 22707 | 22708 | 22709 | 25W LED Max | 1xE27 Globe (Not Included) | |



Forge



- Part of a family of matching pendant, table lamp and floor lamp.

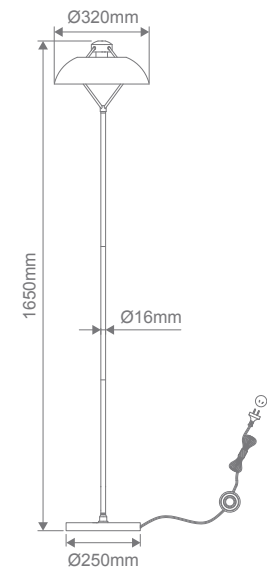

| Item No. | Variant | Wattage | Requires |
|----------|---------|---------|----------|
| | | | |

Interior

Interior



Ashley



- Metal base, thin frame and a wire mesh shade.
- Featuring plated Matt Black with Antique Brass highlights.
- Part of a family of matching pendant, table lamp, floor lamp and desk lamp.

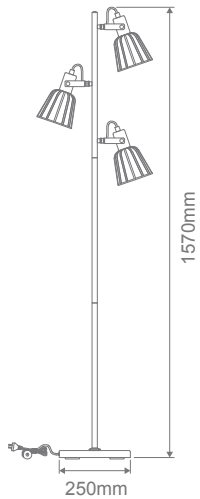

| Item No. | Variant | Wattage | Requires |
|------------|---------|---------------|-----------------------------|
| ASHLEY-3FL | 22517 | 3x25W LED Max | 3xE14 Globes (Not Included) |



Cyclops



- Features a 20W LED uplighter (Mother) and a 7W task light (Child).
- Push and hold dimmable function available for both lights.
- Push switchable 4-CCT colour temperature options (3000K - 4000K - 5000K - 6000K).

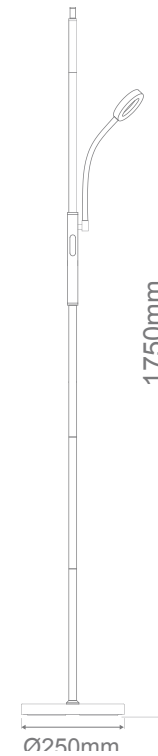

| Item No. | Variant | CCT |
|------------|---------|------|
| CYCLOPS-FL | 22832 | QUAD |



Floor Lamps



Samson

- Features a 30W LED uplighter (Mother) and a 5W task light (Child).
- Push and hold dimmable function available for both lights.
- Push switchable 4-CCT colour temperature options (3000K - 4000K - 5000K - 6000K).

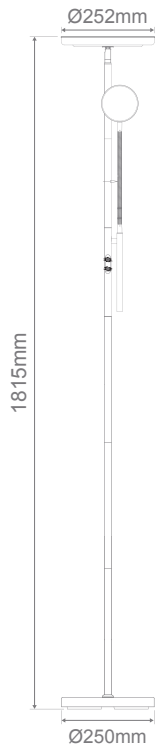

| Item No. | Variant | CCT |
|-----------|---------|------|
| SAMSON-FL | 22830 | QUAD |



Floor Lamps

Eden Series

- Features an 18W LED uplighter (Mother) and a 5W task light (Child).
- Available in Black, Satin Chrome and Antique Brass finishes, with a white frosted glass for the uplighter.
- Dimmable dials available for both lights, producing a nice warm 3000K Warm White LED colour temperature.



Antique Brass

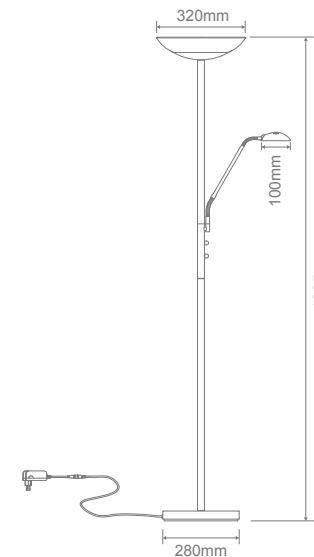

Satin Chrome

Black

| Item No. | Variants | | | CCT |
|----------|----------|-------|-------|-------|
| | A/Brs | Blk | S/Chr | |
| EDEN-FL | 22500 | 22501 | 22502 | 3000K |



Floor Lamps

Elsa Series



- Chrome highlights with painted metal.
- Featuring an adjustable head to direct light to desired area.

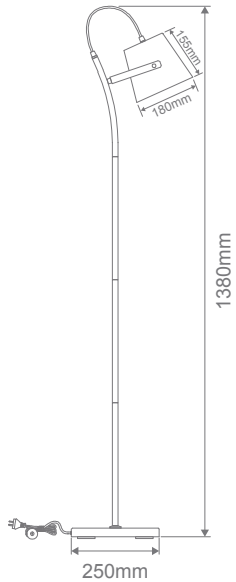

| Item No. | Variants | | Wattage | Requires |
|----------|----------|-------|-------------|----------------------------|
| | Blk | Wht | | |
| ELSA-FL | 22533 | 22534 | 25W LED Max | 1xE27 Globe (Not Included) |



Floor Lamps

Leah Series



- Metal base, thin metal frame and a traditional conical shade.
- Available Matt White and Matt Black with Antique Brass highlights.
- Part of a family of matching desk lamp and floor lamp.

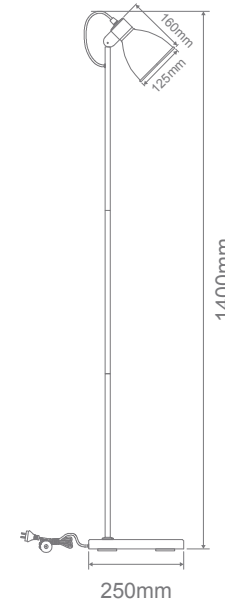

| Item No. | Variants | | Wattage | Requires |
|----------|----------|-------|-------------|----------------------------|
| | Blk | Wht | | |
| LEAH-FL | 22539 | 22540 | 25W LED Max | 1xE27 Globe (Not Included) |



Marisol



- White marble base, thin frame and metal cylindrical shade.
- Featuring plated Antique Brass and painted Black Shade.
- Part of a family of matching desk lamp and floor lamp.

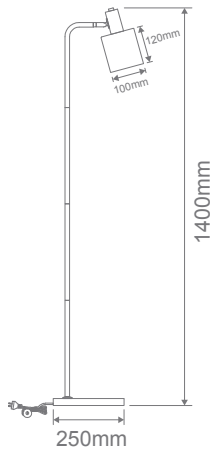

| Item No. | Variant | Wattage | Requires |
|------------|---------|-------------|----------------------------|
| MARISOL-FL | 22523 | 25W LED Max | 1xE14 Globe (Not Included) |



Rustica



- Metal base, thin frame and a wire mesh shade.
- Featuring plated Matt Black with Antique Brass highlights.
- Part of a family of matching desk lamp and floor lamp.

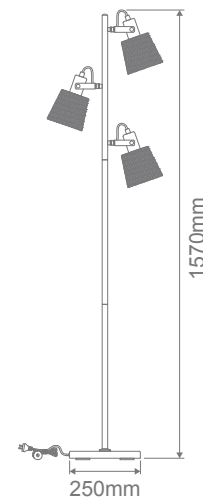

| Item No. | Variant | Wattage | Requires |
|------------|---------|---------------|-----------------------------|
| RUSTICA-FL | 22520 | 3x25W LED Max | 3xE14 Globes (Not Included) |



Tinley Series



- Slim metal tube design and an adjustable knuckle holding a stylish dome shade.
- Available in Antique Chrome, Antique Brass and Antique Copper.
- Part of a family of matching table lamp and floor lamp.



| Item No. | Variants | | | Wattage | Requires |
|-----------|----------|-------|-------|-------------|----------------------------|
| | Abrs | Achr | Acop | | |
| TINLEY-FL | 22529 | 22530 | 22531 | 25W LED Max | 1xE27 Globe (Not Included) |



Carter Series



- Modern thin paper rope shade design.
- Featuring Matt Black metalware with a choice of Black or Natural colour shade options.



| Item No. | Variants | | Wattage | Requires |
|-----------|----------|-------|-------------|----------------------------|
| | Blk | Ntr | | |
| CARTER-FL | 23150 | 23151 | 25W LED Max | 1xE27 Globe (Not Included) |

Interior

Interior



Bedside Light



Charge-01 Series



- Bedside wall light with wireless charging phone shelf.
- USB Charging port.
- 2W Focus Tricolour Swithable light.
- Fully dimmable with suitable dimmers.

Wireless Charging Shelf

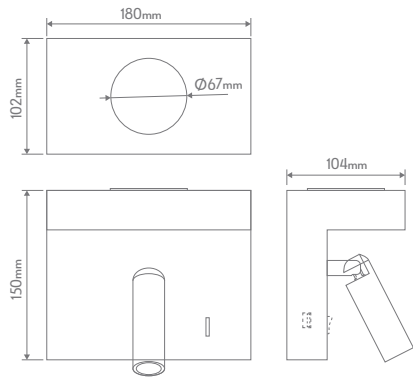

| Item No. | Variants | | Wattage | IP Rating | CCT | Lumen Output | |
|------------------|--------------|--------------|---------|-----------|------|--------------|---------|
| | Blk | Wht | | | | Focus | Ambient |
| CHARGE-01 | 22695 | 22696 | 2W | 20 | TRIO | 350lm | 300lm |



Bedside Light

Charge-02 Series



- Touch Switch.
- Left and right USB charging ports.
- Dimmable by pressing and holding touch switch.
- Focus LED Light + Backlit LED Light.
- Bedside wall light with phone shelf.



This model features a backlit LED Light, but requires cable to plug into USB to charge phone

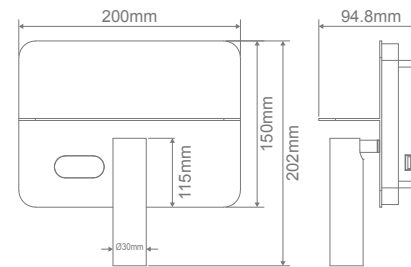

| Item No. | Variants | | Wattage | | IP Rating | CCT | Lumen Output | |
|------------------|--------------|--------------|---------|---------|-----------|-------|--------------|---------|
| | Blk | Wht | Focus | Ambient | | | Focus | Ambient |
| CHARGE-02 | 22697 | 22698 | 4.5W | 4.5W | 40 | 3000K | 350lm | 300lm |



LUMALINE-2-900



SHADOWLINE-900

Interior

Interior

Lumaline-2 Series



- Profile includes Driver and Plex-19.2 strip.
- Light emits upwards and downwards.
- Aluminium profile and PMMA opal diffuser.
- Made to order in Australia from local and imported components.

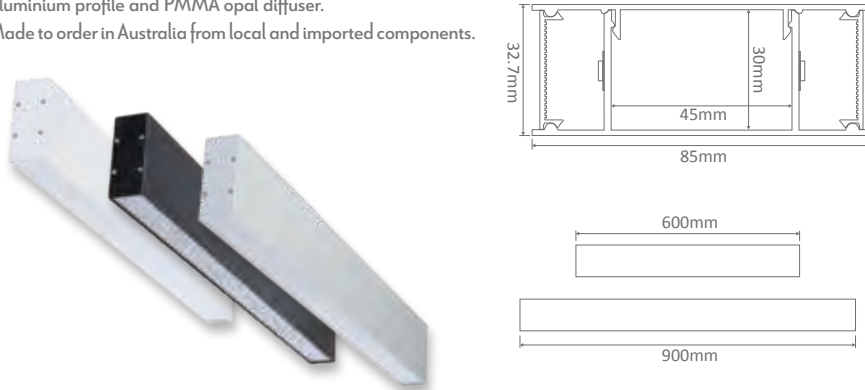

| Item No. | Variants | Wattage | Colour | IP Rating | CCT | Lumen Output |
|----------------|----------|---------|-----------|-----------|----------|--------------|
| LUMALINE-2-600 | 23600 | 2x11.5W | Aluminium | 20 | 3000K | 2x830lm |
| | 23602 | | | | 4000K | 2x899lm |
| | 23604 | | | | 5000K | 2x899lm |
| | 23610 | | 3000K | | 2x830lm | |
| | 23612 | | 4000K | | 2x899lm | |
| | 23614 | | 5000K | | 2x899lm | |
| | 23620 | | 3000K | | 2x830lm | |
| | 23622 | | 4000K | | 2x899lm | |
| | 23624 | | 5000K | | 2x899lm | |
| LUMALINE-2-900 | 23650 | 2x17.5W | Aluminium | 20 | 3000K | 2x1244lm |
| | 23652 | | | | 4000K | 2x1348lm |
| | 23654 | | | | 5000K | 2x1348lm |
| | 23660 | | 3000K | | 2x1244lm | |
| | 23662 | | 4000K | | 2x1348lm | |
| | 23664 | | 5000K | | 2x1348lm | |
| | 23670 | | 3000K | | 2x1244lm | |
| | 23672 | | 4000K | | 2x1348lm | |
| | 23674 | | 5000K | | 2x1348lm | |

Shadowline Series



- Profile includes Driver and Plex-14.4 strip.
- Aluminium profile and PMMA opal diffuser.
- Made to order in Australia from local and imported components.

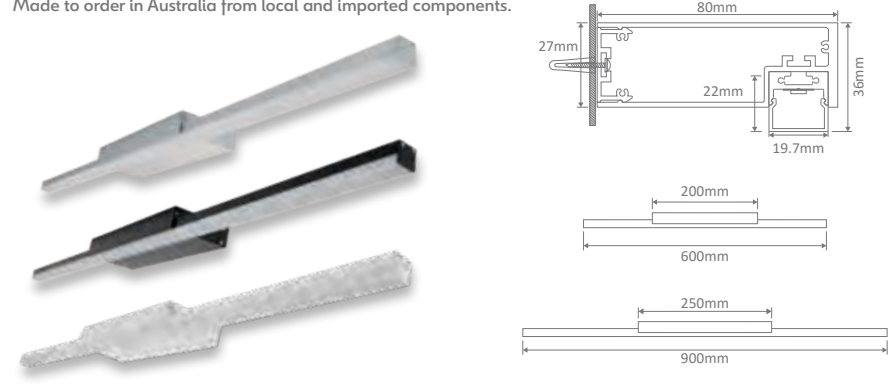

| Item No. | Variants | Wattage | Colour | IP Rating | CCT | Lumen Output |
|----------------|----------|---------|-----------|-----------|--------|--------------|
| SHADOWLINE-600 | 23500 | 9W | Aluminium | 20 | 3000K | 660lm |
| | 23502 | | | | 4000K | 708lm |
| | 23504 | | | | 5000K | 708lm |
| | 23510 | | 3000K | | 660lm | |
| | 23512 | | 4000K | | 708lm | |
| | 23514 | | 5000K | | 708lm | |
| | 23520 | | 3000K | | 660lm | |
| | 23522 | | 4000K | | 708lm | |
| | 23524 | | 5000K | | 708lm | |
| SHADOWLINE-900 | 23550 | 13W | Aluminium | 20 | 3000K | 990lm |
| | 23552 | | | | 4000K | 1062lm |
| | 23554 | | | | 5000K | 1062lm |
| | 23560 | | 3000K | | 990lm | |
| | 23562 | | 4000K | | 1062lm | |
| | 23564 | | 5000K | | 1062lm | |
| | 23570 | | 3000K | | 990lm | |
| | 23572 | | 4000K | | 1062lm | |
| | 23574 | | 5000K | | 1062lm | |



Strap Series

- Part of a family of matching pendant, table, floor lamp and wall light.

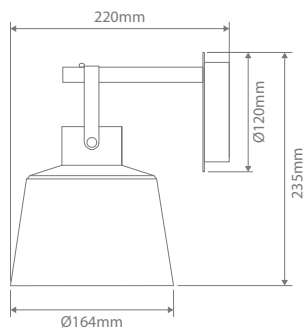

| Item No. | Variants | | Wattage | Requires |
|----------|----------|-------|-------------|-----------------------------|
| | Blk | Wht | | |
| STRAP-WB | 22722 | 22723 | 25W LED Max | 1x E27 Globe (Not Included) |



Glow 8 Series

- Cast Aluminium, powder coated.
- Inbuilt LED driver included.
- Fully dimmable with suitable dimmers.



Dip Switch

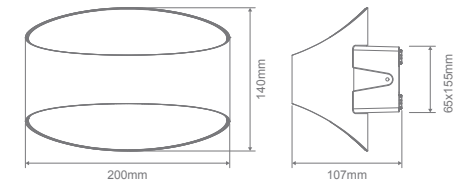

| Item No. | Variants | | Wattage | IP Rating | CCT | Lumen Output | | |
|----------|----------|-------|---------|-----------|------|----------------|----------------|----------------|
| | Blk | Wht | | | | Warm White | Neutral White | White |
| GLOW-8 | 22660 | 22661 | 8W | 20 | TRIO | 3000K 320lm | 4000K 350lm | 5700K 400lm |

Interior

Interior



Moon Wall Series

- SMD LED Chip.
- 6W/9W Power Switchable.
- 45° Tiltable, 355° Rotatable.
- Fully dimmable with suitable dimmers.
- Optional coloured baffles available for Tube or Spot Reflectors.
- CRI 90



MOON-WALL-SPOT

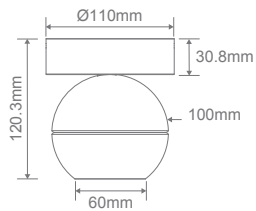

MOON-WALL-TUBE

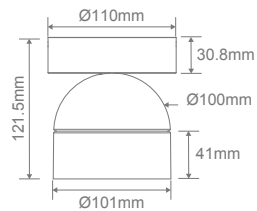

MOON-WALL-OPAL

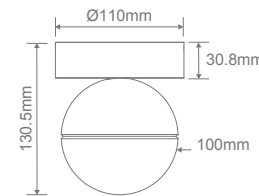

MOON-WALL-FLD

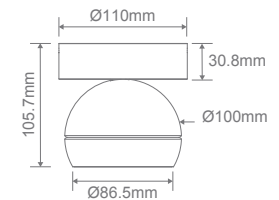

| Item No. | Variants | | Wattage | IP | CCT | |
|-----------|----------|-------|---------|------|-----|------|
| | Blk | Wht | | | | |
| MOON-WALL | FLD | 22820 | 22821 | 6/9W | 20 | TRIO |
| | OPAL | 22822 | 22823 | | | |
| | SPOT | 22824 | 22825 | | | |
| | TUBE | 22826 | 22827 | | | |

| 6W - Lumen Output | | | | | | | | | | | |
|-------------------|-----------|----------|----------|---------------------|-----------|----------|----------|-------------|-----------|----------|----------|
| Warm White 3000K | | | | Neutral White 4000K | | | | White 5700K | | | |
| Fld-60° | Opal-130° | Spot-30° | Tube-60° | Fld-60° | Opal-130° | Spot-30° | Tube-60° | Fld-60° | Opal-130° | Spot-30° | Tube-60° |
| 477lm | 433lm | 498lm | 430lm | 556lm | 504lm | 534lm | 504lm | 561lm | 513lm | 536lm | 515lm |

| 9W - Lumen Output | | | | | | | | | | | |
|-------------------|-----------|----------|----------|---------------------|-----------|----------|----------|-------------|-----------|----------|----------|
| Warm White 3000K | | | | Neutral White 4000K | | | | White 5700K | | | |
| Fld-60° | Opal-130° | Spot-30° | Tube-60° | Fld-60° | Opal-130° | Spot-30° | Tube-60° | Fld-60° | Opal-130° | Spot-30° | Tube-60° |
| 651lm | 600lm | 661lm | 593lm | 780lm | 719lm | 756lm | 716lm | 775lm | 729lm | 751lm | 708lm |



Interior

Up to 45° tilt,
355° Rotation

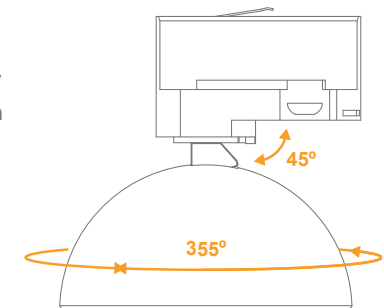



Sinta Series

- Cast Aluminium, powder coated.
- Inbuilt LED driver included.
- Fully dimmable with suitable dimmers.

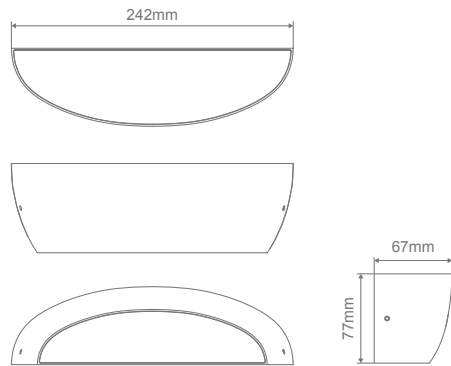

| Item No. | Variants | | Wattage | IP Rating | CCT | Lumen Output | | |
|----------|----------|-------|---------|-----------|------|------------------|---------------------|-------------|
| | Blk | Wht | | | | Warm White 3000K | Neutral White 4000K | White 5700K |
| SINTA-8 | 22674 | 22675 | 8W | 20 | TRIO | 700lm | 725lm | 750lm |



Deens 8

- Cast Aluminium, powder coated.
- Inbuilt LED driver included.
- Fully dimmable with suitable dimmers.

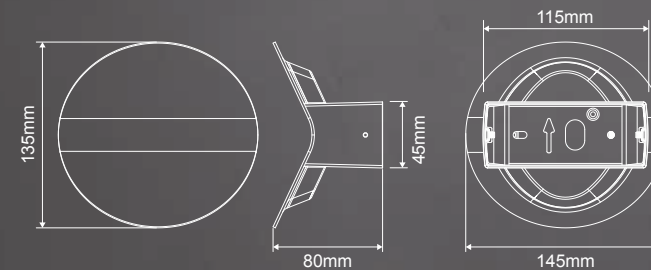

| Item No. | Variants | | Wattage | IP Rating | CCT | Lumen Output | | |
|----------|----------|-------|---------|-----------|------|------------------|---------------------|-------------|
| | Blk | Wht | | | | Warm White 3000K | Neutral White 4000K | White 5700K |
| DEENS-8 | 22679 | 22680 | 8W | 20 | TRIO | 660lm | 680lm | 700lm |

Interior

Interior



Mirror Series

- Aluminium profile and PMMA opal diffuser.
- Adjustable Polished chrome knuckles.

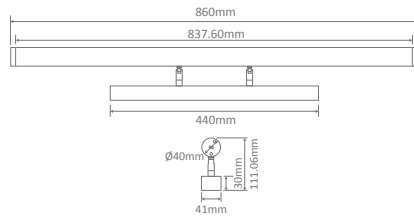
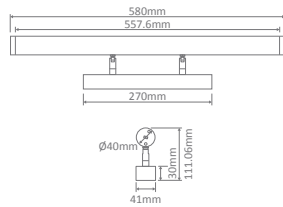

| Item No. | Variants | | | | | Wattage | IP Rating | CCT | Lumen Output | | |
|-----------|----------|-------|-------|-------|-------|---------|-----------|------|------------------|---------------------|-------------|
| | Blk | Chr | Schr | Wht | Sbrs | | | | Warm White 3000K | Neutral White 4000K | White 5700K |
| MIRROR-10 | 12001 | 12003 | 12005 | 12007 | 12009 | 10W | 40 | TRIO | 1040lm | 1110lm | 1180lm |
| MIRROR-15 | 12011 | 12013 | 12015 | 12017 | 12019 | 15W | 40 | TRIO | 1590lm | 1718lm | 1845lm |



Mirror Series

- Aluminium profile and PMMA opal diffuser.
- Adjustable Polished chrome knuckles.

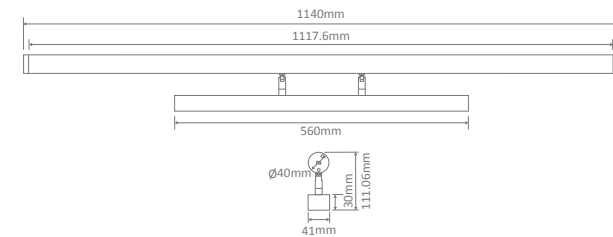

| Item No. | Variants | | | | | Wattage | IP Rating | CCT | Lumen Output | | |
|-----------|----------|-------|-------|-------|-------|---------|-----------|------|------------------|---------------------|-------------|
| | Blk | Chr | Schr | Wht | Sbrs | | | | Warm White 3000K | Neutral White 4000K | White 5700K |
| MIRROR-20 | 12021 | 12023 | 12025 | 12027 | 12029 | 20W | 40 | TRIO | 2100lm | 2200lm | 2300lm |



LED Vanity Lights



Mirror Side Series

- Aluminium profile and PMMA opal diffuser.
- Available in 450mm (6W) and 600mm (8W) sizes.
- Available in White, Black, Chrome and Satin Brass colour options.
- 160° Beam Angle.



MIRROR-SIDE-600



MIRROR-SIDE-450



160° Light Emitting



MIRROR-SIDE-BLACK



MIRROR-SIDE-CHROME



MIRROR-SIDE-SATIN-BRASS



MIRROR-SIDE-WHITE

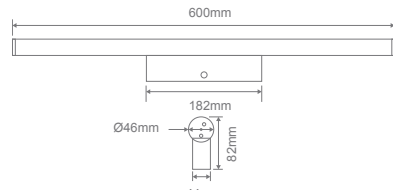
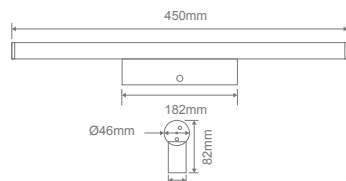

| Item No. | Variants | | | | Wattage | IP Rating | CCT | Lumen Output | | |
|-----------------|----------|-------|-------|-------|---------|-----------|------|------------------|---------------------|-------------|
| | Blk | Chr | Sbrs | Wht | | | | Warm White 3000K | Neutral White 4000K | White 5700K |
| MIRROR-SIDE-450 | 12040 | 12042 | 12043 | 12041 | 6W | 44 | TRIO | 640lm | 735lm | 830lm |
| MIRROR-SIDE-600 | 12046 | 12048 | 12049 | 12047 | 8W | 44 | TRIO | 900lm | 1050lm | 1200lm |



Hollywood Lights

HL-804 Series



White



Black



Chrome



Satin Chrome

| Item No. | Variants | | | | Requires |
|------------|----------|-------|-------|-------|------------------------------|
| | Blk | Chr | Schr | Wht | |
| HL-804-4LT | 16318 | 16320 | 16323 | 16324 | 4x B15 Globes (Not included) |
| HL-804-5LT | 16327 | 16329 | 16332 | 16333 | 5x B15 Globes (Not included) |
| HL-804-6LT | 16336 | 16338 | 16341 | 16342 | 6x B15 Globes (Not included) |
| HL-804-7LT | 16345 | 16347 | 16350 | 16351 | 7x B15 Globes (Not included) |
| HL-804-8LT | 16354 | 16356 | 16359 | 16360 | 8x B15 Globes (Not included) |

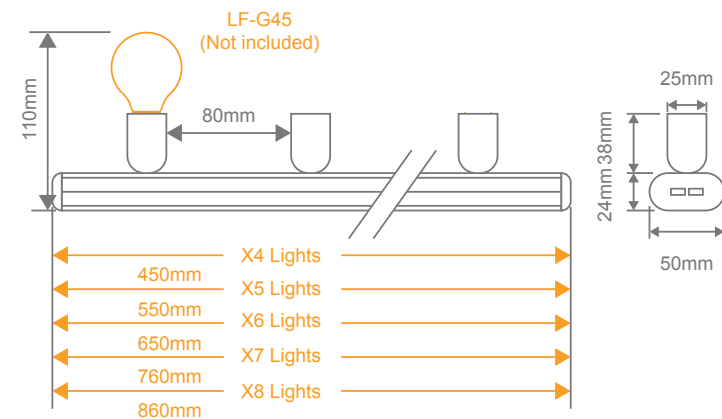



Interior



BF-2012

Raw ceramic modern uplight wall light. Ceramic areas can be painted with any water based paint.

| Item No. | Variants | Colour | Lamp |
|----------|----------|--------|---------------------|
| BF-2012 | 11034 | Raw | 1xG9 (Not Included) |

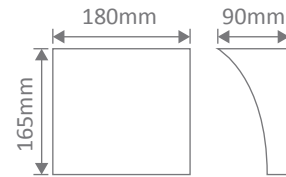

Replacement Globe

KEY-G9-TRIO 65126



BF-2013

Raw ceramic modern uplight wall light. Ceramic areas can be painted with any water based paint.

| Item No. | Variants | Colour | Lamp |
|----------|----------|--------|---------------------|
| BF-2013 | 11074 | Raw | 1xG9 (Not Included) |

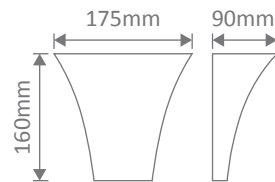

Replacement Globe

KEY-G9-TRIO 65126

Interior

BF-2014

Raw ceramic modern uplight wall light. Ceramic areas can be painted with any water based paint.

| Item No. | Variants | Colour | Lamp |
|----------|----------|--------|---------------------|
| BF-2014 | 11035 | Raw | 2xG9 (Not Included) |

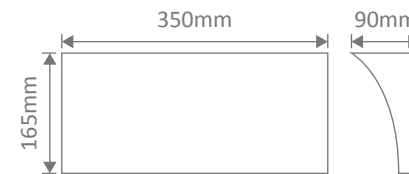

Replacement Globe

KEY-G9-TRIO 65126

BF-2018

Raw ceramic modern uplight wall light. Ceramic areas can be painted with any water based paint.

| Item No. | Variants | Colour | Lamp |
|----------|----------|--------|---------------------|
| BF-2018 | 11075 | Raw | 1xG9 (Not Included) |



Replacement Globe

KEY-G9-TRIO 65126



BF-2019

Raw ceramic modern uplight wall light. Ceramic areas can be painted with any water based paint.

| Item No. | Variants | Colour | Lamp |
|----------|----------|--------|---------------------|
| BF-2019 | 11076 | Raw | 2xG9 (Not Included) |

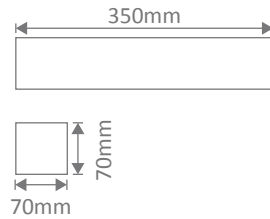

Replacement Globe

KEY-G9-TRIO 65126

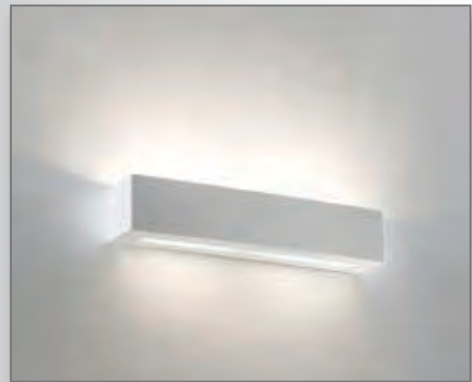

BF-2020

Raw ceramic modern uplight wall light. Ceramic areas can be painted with any water based paint.

| Item No. | Variants | Colour | Lamp |
|----------|----------|--------|---------------------|
| BF-2020 | 11077 | Raw | 2xG9 (Not Included) |



Replacement Globe

KEY-G9-TRIO 65126

BF-2185

Raw ceramic wall light. Ceramic areas can be painted with any water based paint.

| Item No. | Variants | Colour | Lamp |
|----------|----------|--------|---------------------|
| BF-2185 | 11036 | Raw | 1xG9 (Not Included) |

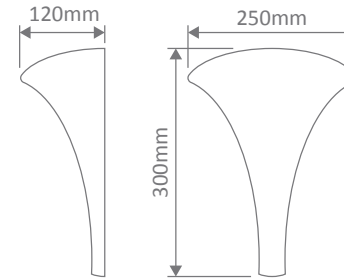

Replacement Globe

KEY-G9-TRIO 65126

BF-2350

Raw modern round indirect wall light. Creates a soft and subtle feature for feature wall lighting. Ceramic areas can be painted with any water based paint.

| Item No. | Variants | Colour | Lamp |
|----------|----------|--------|---------------------|
| BF-2350 | 11080 | Raw | 1xG9 (Not Included) |

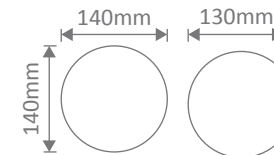

Replacement Globe

KEY-G9-TRIO 65126



BF-2440

Raw ceramic modern uplight wall light. Ceramic areas can be painted with any water based paint.

| Item No. | Variants | Colour | Lamp |
|----------|----------|--------|----------------------|
| BF-2440 | 11081 | Raw | 1xE27 (Not Included) |

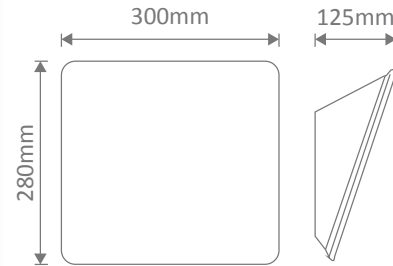

BF-2601A

Raw ceramic modern uplight wall light. Ceramic areas can be painted with any water based paint.

| Item No. | Variants | Colour | Lamp |
|----------|----------|--------|---------------------|
| BF-2601A | 11082 | Raw | 1xG9 (Not Included) |

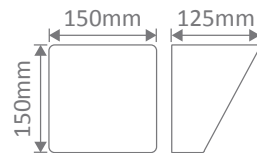

Replacement Globe

KEY-G9-TRIO

65126



BF-2601B

Raw ceramic modern uplight wall light. Ceramic areas can be painted with any water based paint.

| Item No. | Variants | Colour | Lamp |
|----------|----------|--------|---------------------|
| BF-2601B | 11083 | Raw | 1xG9 (Not Included) |

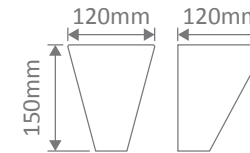

Replacement Globe

KEY-G9-TRIO

65126

BF-2607A

Raw ceramic uplight wall light. Light emits Upwards only. Ceramic areas can be painted with any water based paint

| Item No. | Variants | Colour | Lamp |
|----------|----------|--------|---------------------|
| BF-2607A | 11084 | Raw | 1xG9 (Not Included) |



Replacement Globe

KEY-G9-TRIO

65126



BF-2607B

Raw ceramic wall light. Light emits upwards and downwards through an opening in the bottom of the fitting. Ceramic areas can be painted with any water based paint

| Item No. | Variants | Colour | Lamp |
|-----------------|--------------|--------|---------------------|
| BF-2607B | 11085 | Raw | 1xG9 (Not Included) |

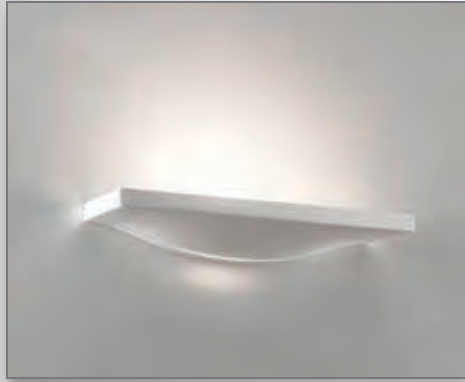

Replacement Globe

KEY-G9-TRIO

65126



BF-2608A

Raw ceramic uplight wall light. Light emits Upwards only. Ceramic areas can be painted with any water based paint.

| Item No. | Variants | Colour | Lamp |
|-----------------|--------------|--------|---------------------|
| BF-2608A | 11090 | Raw | 2xG9 (Not Included) |

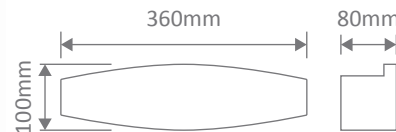

Replacement Globe

KEY-G9-TRIO

65126



BF-7577

Raw ceramic wall light. Ceramic areas can be painted with any water based paint

| Item No. | Variants | Colour | Lamp |
|----------------|--------------|--------|----------------------|
| BF-7577 | 11042 | Raw | 1xE27 (Not Included) |

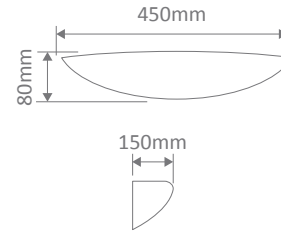

BF-7578

Raw ceramic wall light. Ceramic areas can be painted with any water based paint.

| Item No. | Variants | Colour | Lamp |
|----------------|--------------|--------|----------------------|
| BF-7578 | 11044 | Raw | 1xE27 (Not Included) |

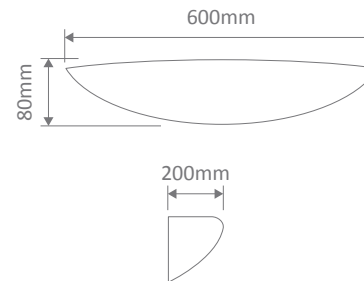

Interior

Interior



BF-2608B

Raw ceramic wall light. Light emits upwards and downwards through an opening in the bottom of the fitting. Ceramic areas can be painted with any water based paint.

| Item No. | Variants | Colour | Lamp |
|----------|----------|--------|---------------------|
| BF-2608B | 11091 | Raw | 2xG9 (Not Included) |

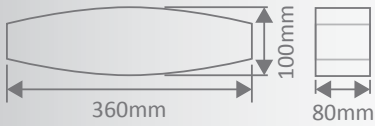

Replacement Globe

KEY-G9-TRIO 65126



BF-7310

Raw ceramic wall light. Ceramic areas can be painted with any water based paint. Made in Italy.

| Item No. | Variants | Colour | Lamp |
|----------|----------|--------|----------------------|
| BF-7310 | 11040 | Raw | 1xE27 (Not Included) |

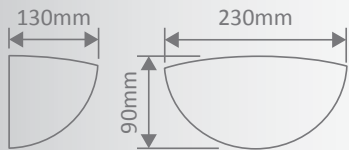

BF-2608B



BF-7603

Raw ceramic wall light complete with frosted glass.
Ceramic areas can be painted with any water based paint.

| Item No. | Variants | Colour | Lamp |
|----------|----------|--------|----------------------|
| BF-7603 | 11049 | Raw | 1xE27 (Not Included) |

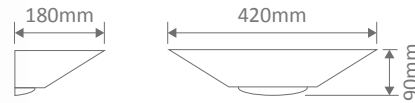

BF-7908

Raw ceramic wall light complete with frosted glass.
Ceramic areas can be painted with any water based paint.

| Item No. | Variants | Colour | Lamp |
|----------|----------|--------|----------------------|
| BF-7908 | 11051 | Raw | 1xE27 (Not Included) |

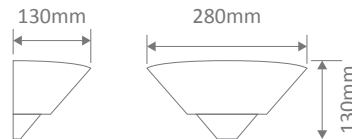

BF-7949

Raw ceramic wall light complete with frosted glass.
Ceramic areas can be painted with any water based paint. Corner mounted installations only.

| Item No. | Variants | Colour | Lamp |
|----------|----------|--------|----------------------|
| BF-7949 | 11101 | Raw | 1xE27 (Not Included) |

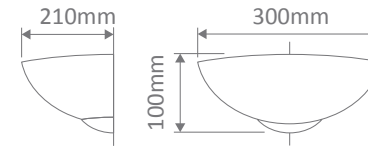

BF-8042

Raw ceramic wall light complete with frosted glass.
Ceramic areas can be painted with any water based paint.

| Item No. | Variants | Colour | Lamp |
|----------|----------|--------|----------------------|
| BF-8042 | 11102 | Raw | 1xE27 (Not Included) |

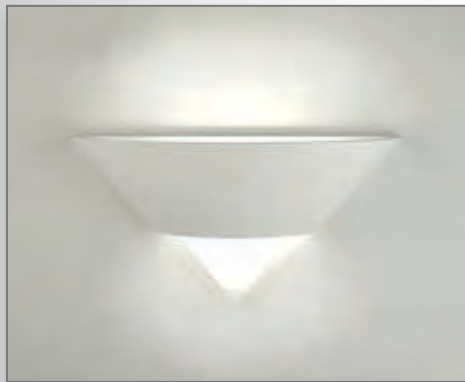



BF-8235

Raw ceramic wall light complete with open slot.
Ceramic areas can be painted with any water based paint.

| Item No. | Variants | Colour | Lamp |
|----------|----------|--------|----------------------|
| BF-8235 | 11115 | Raw | 1xE27 (Not Included) |

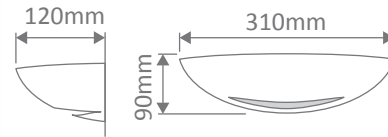

BF-8258

Raw ceramic wall light complete with frosted glass.
Ceramic areas can be painted with any water based paint.

| Item No. | Variants | Colour | Lamp |
|----------|----------|--------|----------------------|
| BF-8258 | 11116 | Raw | 1xE27 (Not Included) |

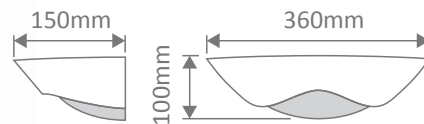

BF-8284

Raw ceramic wall light complete with frosted glass. Ceramic areas can be painted with any water based paint.

| Item No. | Variants | Colour | Lamp |
|----------|----------|--------|---------------------|
| BF-8284 | 11121 | Raw | 2xG9 (Not Included) |

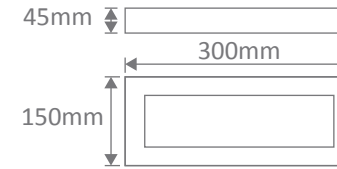

Replacement Globe

KEY-G9-TRIO

65126

BF-8286

Raw ceramic wall light complete with frosted glass. Ceramic areas can be painted with any water based paint.

| Item No. | Variants | Colour | Lamp |
|----------|----------|--------|----------------------|
| BF-8286 | 11122 | Raw | 1xE27 (Not Included) |

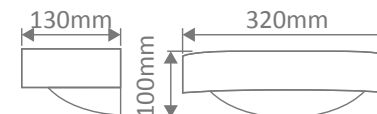



Interior

Interior

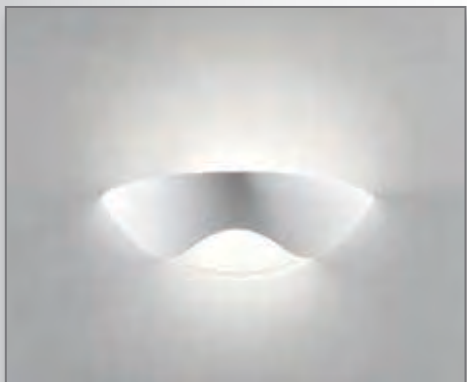

BF-8259

Raw ceramic wall light complete with frosted glass. Ceramic areas can be painted with any water based paint.

| Item No. | Variants | Colour | Lamp |
|----------|----------|--------|----------------------|
| BF-8259 | 11118 | Raw | 1xE27 (Not Included) |

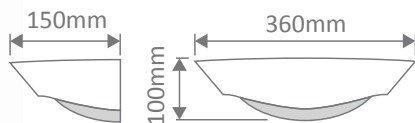

BF-8411

Raw ceramic wall light complete with frosted glass. Ceramic areas can be painted with any water based paint.

| Item No. | Variants | Colour | Lamp |
|----------|----------|--------|----------------------|
| BF-8411 | 11131 | Raw | 1xE27 (Not Included) |

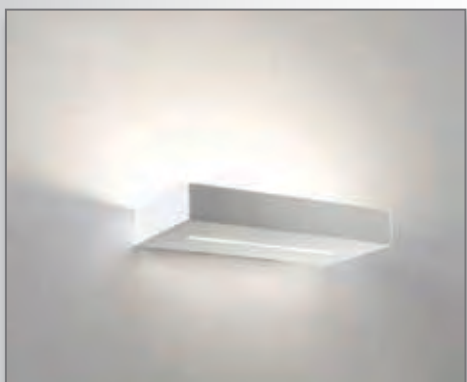
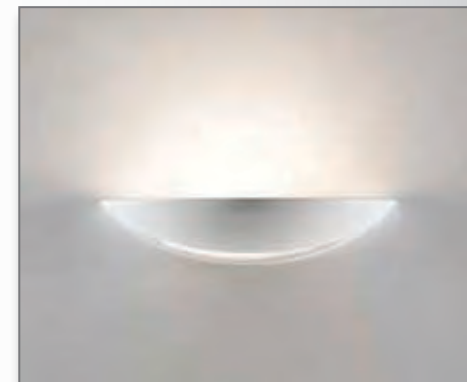
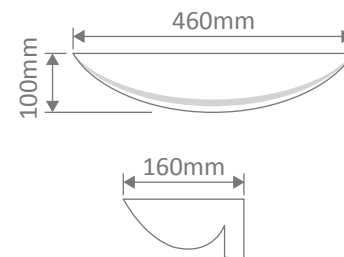

BF-8276

Raw ceramic wall light. Ceramic areas can be painted with any water based paint.

| Item No. | Variants | Colour | Lamp |
|----------|----------|--------|---------------------|
| BF-8276 | 11120 | Raw | 2xG9 (Not Included) |

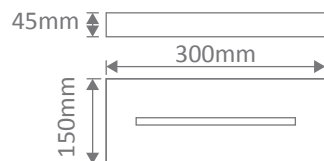

BF-8418

Raw ceramic wall light. Light emits both ways. Ceramic areas can be painted with any water based paint.

| Item No. | Variants | Colour | Lamp |
|----------|----------|--------|---------------------|
| BF-8418 | 11037 | Raw | 2xG9 (Not Included) |

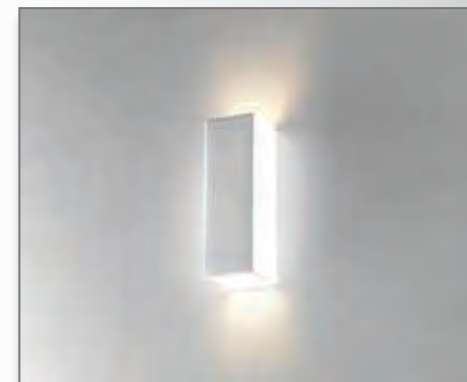
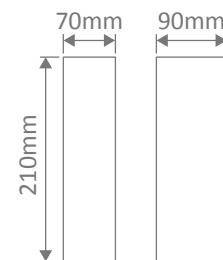

Replacement Globe

KEY-G9-TRIO

65126

Replacement Globe

KEY-G9-TRIO

65126



LED Step Lights



Camino Series

- Cast Aluminium, powder coated.
- Inbuilt LED driver included (240V Version).
- Tricolour Switchable.
- Fully dimmable with suitable dimmers (240V Version).

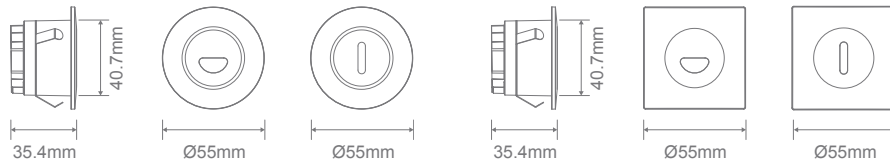

Cut-out: Ø45mm

Cut-out: Ø45mm

| Item No. | Variant | | Wattage | IP Rating | CCT | Lumen Output | | |
|-----------------|---------|-------|---------|-----------|------|------------------|---------------------|-------------|
| | Blk | Wht | | | | Warm White 3000K | Neutral White 4000K | White 5000K |
| CAMINO-240V-RND | ASY | 21747 | 3W | 54 | TRIO | 62lm | 73lm | 66lm |
| | SLOT | 21741 | | | | | | |
| CAMINO-240V-SQR | ASY | 21745 | 3W | 54 | TRIO | 62lm | 73lm | 66lm |
| | SLOT | 21743 | | | | | | |



LED Step Lights



Camino Series

- Cast Aluminium, powder coated.
- Inbuilt LED driver included (240V Version).
- Tricolour Switchable.
- Fully dimmable with suitable dimmers (240V Version).



The driver can be detached from the fitting

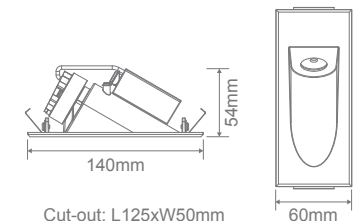

Cut-out: L125xW50mm

| Item No. | Variant | | Wattage | IP Rating | CCT | Lumen Output | | |
|------------------|---------|-------|---------|-----------|------|------------------|---------------------|-------------|
| | Blk | Wht | | | | Warm White 3000K | Neutral White 4000K | White 5000K |
| CAMINO-240V-RECT | 21767 | 21763 | 3W | 54 | TRIO | 120lm | 140lm | 125lm |

Strike 48

3 Blade 48" Ceiling Fan with no light / with optional light kit

DC Motor
ABS Polymer motor, canopy and blades
Winter/Summer Function

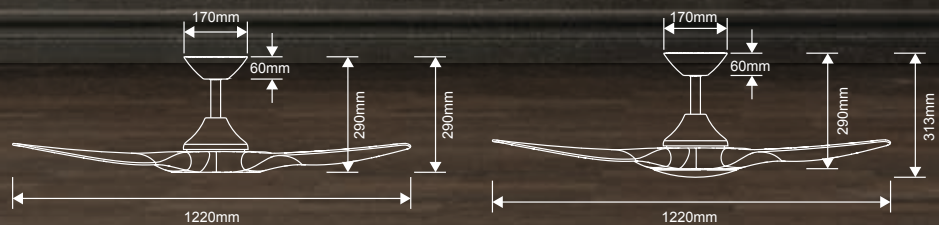

STRIKE-48

STRIKE-48-L

| Item No. | Variants | | | |
|------------------|----------|---------|---------|---------|
| | Wht/Wht | Blk/Blk | Blk/Wnt | Wht/Oak |
| STRIKE-48 | 60130 | 60131 | 60132 | 60133 |
| STRIKE-LIGHT-KIT | Blk | | Wht | |
| | 60141 | | 60140 | |
| CFA-DR1 | 60100 | | 60101 | |



Strike Light Kit

Optional Light Kit (Adaptable)
LED CCT Switchable Light



Specification Features

| | | AirFlow m ³ /h | |
|--------------------------|--------------------------------------|---------------------------|--------|
| | | Speed | |
| Input Voltage: | 240V AC | 1 | 3975 |
| Motor: | 25W | 2 | 5086 |
| Type of Motor: | DC | 3 | 8646 |
| Blade Pitch: | 13° | 4 | 9768 |
| Blade Length: | 48" - 1220mm | 5 | 10,585 |
| Construction: | ABS Polymer motor, canopy and blades | 6 | 11,202 |
| Winter/Summer Function: | Yes | 7 | 12,653 |
| IP Rating: | IPX0 | 8 | 13,048 |
| Extension Rod Available: | Yes | 9 | 13,859 |
| Remote Control: | Yes (9 Speed) | | |

Optional Light Kit

| | | | |
|---------------------------|-----------------------|---------------|---------------|
| Luminaire (LED): | 18W | Lumen Output: | |
| CCT: | 3000K - 4000K - 6000K | 3000K | 4000K 6000K |
| Dimmable: | Yes | 1800lm | 1900lm 1950lm |
| Luminaire Lifespan (hrs): | 10,000hrs | | |

Warranty:

| | |
|----------------------|---|
| Fan: | 3 Year In Home + 3 Year Parts Replacement |
| Receiver and remote: | 1 Year In Home + 1 Year Parts Replacement |

Accessories sold separately: Bluetooth Wall Control & Extension Rods.

Note: Do NOT install on a raked or sloped ceiling without the use of the optional 38° Ceiling Kit, as this will damage the receiver housed in the canopy.



Strike 60

3 Blade 60" Ceiling Fan with no light / with optional light kit

DC Motor
ABS Polymer motor, canopy and blades
Winter/Summer Function

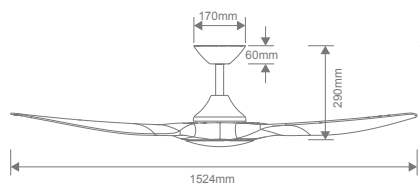

STRIKE-60

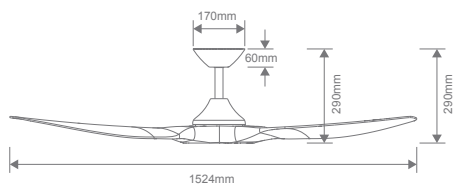

STRIKE-60-L

| Item No. | Variants | | | |
|------------------|----------|---------|---------|---------|
| | Wht/Wht | Blk/Blk | Blk/Wht | Wht/Oak |
| STRIKE-60 | 60135 | 60136 | 60137 | 60138 |
| STRIKE-LIGHT-KIT | Blk | | Wht | |
| | 60141 | | 60140 | |
| CFA-DR1 | 60100 | | 60101 | |



Strike Light Kit

Optional Light Kit (Adaptable)
LED CCT Switchable Light



Specification Features

| | | AirFlow m ³ /h | |
|--------------------------|--------------------------------------|---------------------------|--------|
| | | Speed | |
| Input Voltage: | 240V AC | 1 | 4558 |
| Motor: | 35W | 2 | 5672 |
| Type of Motor: | DC | 3 | 6113 |
| Blade Pitch: | 13° | 4 | 7977 |
| Blade Length: | 60" - 1520mm | 5 | 9,842 |
| Construction: | ABS Polymer motor, canopy and blades | 6 | 10,249 |
| Winter/Summer Function: | Yes | 7 | 12,113 |
| IP Rating: | IPX0 | 8 | 14,245 |
| Extension Rod Available: | Yes | 9 | 16,302 |
| Remote Control: | Yes (9 Speed) | | |

Optional Light Kit

| | | | | |
|---------------------------|-----------------------|---------------|--------|--------|
| Luminaire (LED): | 18W | Lumen Output: | | |
| CCT: | 3000K - 4000K - 6000K | 3000K | 4000K | 6000K |
| Dimmable: | Yes | 1800lm | 1900lm | 1950lm |
| Luminaire Lifespan (hrs): | 10,000hrs | | | |

Warranty:

| | |
|----------------------|---|
| Fan: | 3 Year In Home + 3 Year Parts Replacement |
| Receiver and remote: | 1 Year In Home + 1 Year Parts Replacement |

Accessories sold separately: Bluetooth Wall Control & Extension Rods.

Note: Do NOT install on a raked or sloped ceiling without the use of the optional 38° Ceiling Kit, as this will damage the receiver housed in the canopy.



Blast 48

3 Blade 48" Ceiling Fan with no light / with optional light kit

DC Motor
ABS Polymer motor, canopy and blades
Winter/Summer Function

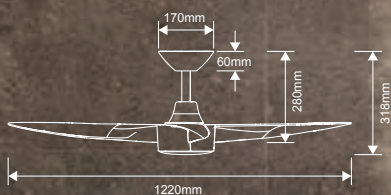

BLAST-48

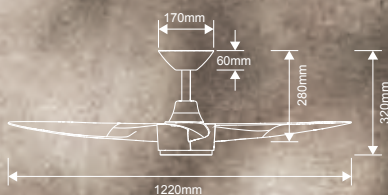

BLAST-48-L

| Item No. | Variants | |
|-----------------|----------|-------|
| | Blk | Wht |
| BLAST-48 | 60146 | 60145 |
| BLAST-LIGHT-KIT | 60152 | 60151 |
| CFA-DR1 | 60100 | 60101 |



Blast Light Kit

Optional Light Kit (Adaptable)
LED CCT Switchable Light



Specification Features

| | AirFlow m ³ /h | |
|--------------------------|--------------------------------------|--------|
| | Speed | |
| Input Voltage: | 240V AC | |
| Motor: | 25W | |
| Type of Motor: | DC | |
| Blade Pitch: | 14.5° | |
| Blade Length: | 48" - 1220mm | |
| Construction: | ABS Polymer motor, canopy and blades | |
| Winter/Summer Function: | Yes | |
| IP Rating: | IPX0 | |
| Extension Rod Available: | Yes | |
| Remote Control: | Yes (9 Speed) | |
| | 1 | 3975 |
| | 2 | 5086 |
| | 3 | 8646 |
| | 4 | 9768 |
| | 5 | 10,585 |
| | 6 | 11,202 |
| | 7 | 12,653 |
| | 8 | 13,048 |
| | 9 | 13,859 |

Optional Light Kit

| | | | |
|---------------------------|-----------------------|---------------|---------------|
| Luminaire (LED): | 18W | Lumen Output: | |
| CCT: | 3000K - 4000K - 6000K | 3000K | 4000K 6000K |
| Dimmable: | Yes | 1800lm | 1900lm 1950lm |
| Luminaire Lifespan (hrs): | 10,000hrs | | |

Warranty:

| | |
|----------------------|---|
| Fan: | 3 Year In Home + 3 Year Parts Replacement |
| Receiver and remote: | 1 Year In Home + 1 Year Parts Replacement |

Accessories sold separately: Bluetooth Wall Control & Extension Rods.

Note: Do NOT install on a raked or sloped ceiling without the use of the optional 38° Ceiling Kit, as this will damage the receiver housed in the canopy.



Blast 52

4 Blade 52" Ceiling Fan with no light / with optional light kit

DC Motor
ABS Polymer motor, canopy and blades
Winter/Summer Function

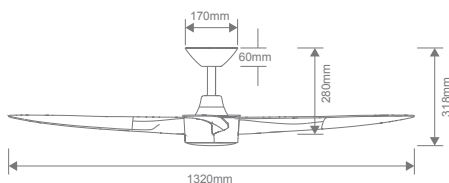

BLAST-52

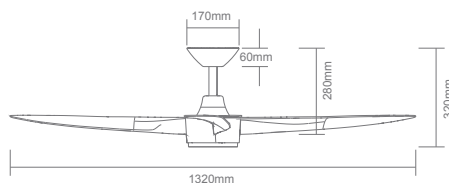

BLAST-52-L

| Item No. | Variants | |
|-----------------|----------|-------|
| | Blk | Wht |
| BLAST-52 | 60149 | 60148 |
| BLAST-LIGHT-KIT | 60152 | 60151 |
| CFA-DR1 | 60100 | 60101 |



Blast Light Kit

Optional Light Kit (Adaptable)
LED CCT Switchable Light



Specification Features

| | | AirFlow m ³ /h | |
|--------------------------|--------------------------------------|---------------------------|--------|
| | | Speed | |
| Input Voltage: | 240V AC | 1 | 4165 |
| Motor: | 25W | 2 | 4673 |
| Type of Motor: | DC | 3 | 8963 |
| Blade Pitch: | 14.5° | 4 | 9990 |
| Blade Length: | 52" - 1320mm | 5 | 10,843 |
| Construction: | ABS Polymer motor, canopy and blades | 6 | 11,665 |
| Winter/Summer Function: | Yes | 7 | 12,074 |
| IP Rating: | IPX0 | 8 | 13,141 |
| Extension Rod Available: | Yes | 9 | 14,305 |
| Remote Control: | Yes (9 Speed) | | |

Optional Light Kit

| | | | |
|---------------------------|-----------------------|---------------|--------|
| Luminaire (LED): | 18W | Lumen Output: | |
| CCT: | 3000K - 4000K - 6000K | 3000K | 6000K |
| Dimmable: | Yes | 1800lm | 1950lm |
| Luminaire Lifespan (hrs): | 10,000hrs | | |

Warranty:

| | |
|----------------------|---|
| Fan: | 3 Year In Home + 3 Year Parts Replacement |
| Receiver and remote: | 1 Year In Home + 1 Year Parts Replacement |

Accessories sold separately: Bluetooth Wall Control & Extension Rods.

Note: Do NOT install on a raked or sloped ceiling without the use of the optional 38° Ceiling Kit, as this will damage the receiver housed in the canopy.



Glide 80

6 Blade 80" Ceiling Fan with no light / with optional light kit

DC Motor
ABS Polymer motor, canopy and blades
Winter/Summer Function

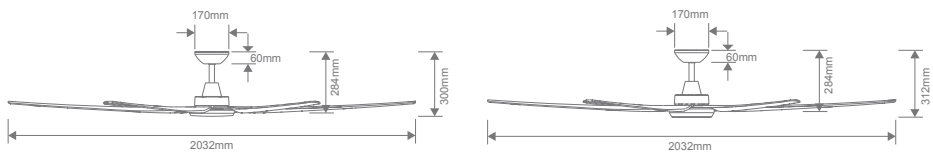

| Item No. | Variants | |
|-----------------|----------|-------|
| | Blk | Wht |
| GLIDE-80 | 60157 | 60156 |
| GLIDE-LIGHT-KIT | 60162 | 60161 |
| CFA-DR1 | 60100 | 60101 |



Glide Light Kit

Optional Light Kit (Adaptable)
LED CCT Switchable Light



Specification Features

| | | AirFlow m ³ /h | |
|--------------------------|--------------------------------------|---------------------------|--------|
| | | Speed | |
| Input Voltage: | 240V AC | 1 | 11,058 |
| Motor: | 25W | 2 | 13,267 |
| Type of Motor: | DC | 3 | 14,417 |
| Blade Pitch: | 13° | 4 | 15,696 |
| Blade Length: | 80" - 2030mm | 5 | 16,529 |
| Construction: | ABS Polymer motor, canopy and blades | 6 | 17,438 |
| Winter/Summer Function: | Yes | 7 | 17,615 |
| IP Rating: | IPX0 | 8 | 18,254 |
| Extension Rod Available: | Yes | 9 | 22,318 |
| Remote Control: | Yes (9 Speed) | | |

Optional Light Kit

| | | Lumen Output: | | |
|---------------------------|-----------------------|---------------|--------|--------|
| Luminaire (LED): | 18W | 3000K | 4000K | 6000K |
| CCT: | 3000K - 4000K - 6000K | 1800lm | 1900lm | 1950lm |
| Dimmable: | Yes | | | |
| Luminaire Lifespan (hrs): | 10,000hrs | | | |

Warranty:

| | |
|----------------------|---|
| Fan: | 3 Year In Home + 3 Year Parts Replacement |
| Receiver and remote: | 1 Year In Home + 1 Year Parts Replacement |

Accessories sold separately: Bluetooth Wall Control & Extension Rods.

Note: Do NOT install on a raked or sloped ceiling without the use of the optional 38° Ceiling Kit, as this will damage the receiver housed in the canopy.



Air Movement

Air Movement



Axis 48 3 Blade 48" Ceiling Fan with no light

DC Motor
ABS Polymer motor, canopy and blades
Winter/Summer Function

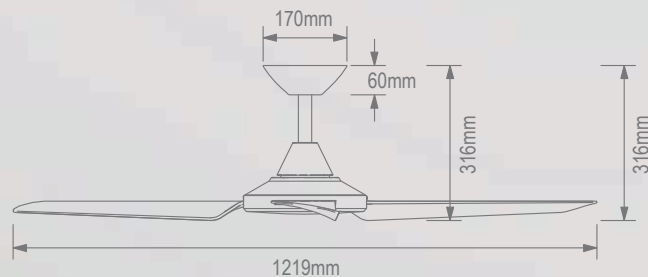

AXIS-48

| Item No. | Variants | | CCT | Wattage | Luminaire Wattage | Blade Pitch | Tropically Rated | Remote Control |
|----------------|--------------|--------------|------|---------|-------------------|-------------|------------------|----------------|
| | Blk | Wht | | | | | | |
| AXIS-48 | 60020 | 60021 | TRIO | 26W | 18W | 14.5° | Yes | Yes |

Accessories sold separately: Bluetooth Wall Control & Extension Rods.

Note: Do NOT install on a raked or sloped ceiling without the use of the optional 38° Ceiling Kit, as this will damage the receiver housed in the canopy.

Axis 48 Light 3 Blade 48" Ceiling Fan with light

DC Motor
ABS Polymer motor, canopy and blades
Winter/Summer Function
LED CCT Switchable Light

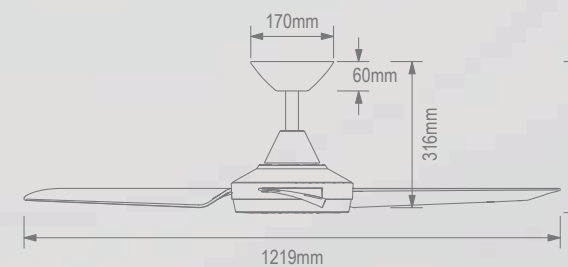

AXIS-48-L

| Item No. | Variants | | CCT | Wattage | Luminaire Wattage | Blade Pitch | Tropically Rated | Remote Control |
|----------------------|--------------|--------------|------|---------|-------------------|-------------|------------------|----------------|
| | Blk | Wht | | | | | | |
| AXIS-48-LIGHT | 60030 | 60031 | TRIO | 26W | 18W | 14.5° | Yes | Yes |

Accessories sold separately: Bluetooth Wall Control & Extension Rods.

Note: Do NOT install on a raked or sloped ceiling without the use of the optional 38° Ceiling Kit, as this will damage the receiver housed in the canopy.



Ceiling Fans

Motion 52

4 Blade 52" Ceiling Fan with no light

DC Motor
ABS Polymer motor, canopy and blades
Winter/Summer Function

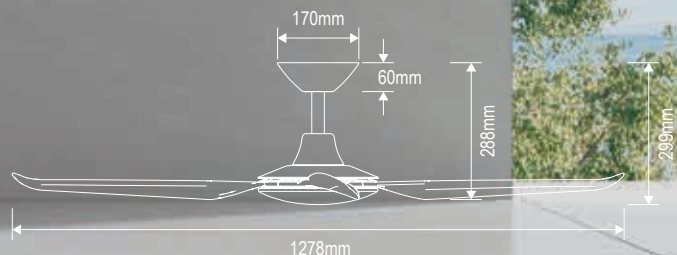

AXIS-48

| Item No. | Variants | | CCT | Wattage | Luminaire Wattage | Blade Pitch | Tropically Rated | Remote Control |
|------------------|--------------|--------------|------|---------|-------------------|-------------|------------------|----------------|
| | Blk | Wht | | | | | | |
| MOTION-52 | 60040 | 60041 | TRIO | 26W | 18W | 14.5° | Yes | Yes |

Accessories sold separately: Bluetooth Wall Control & Extension Rods.

Note: Do NOT install on a raked or sloped ceiling without the use of the optional 38° Ceiling Kit, as this will damage the receiver housed in the canopy.



Ceiling Fans

Motion 52 Light

4 Blade 52" Ceiling Fan with light

DC Motor
ABS Polymer motor, canopy and blades
Winter/Summer Function
LED CCT Switchable Light

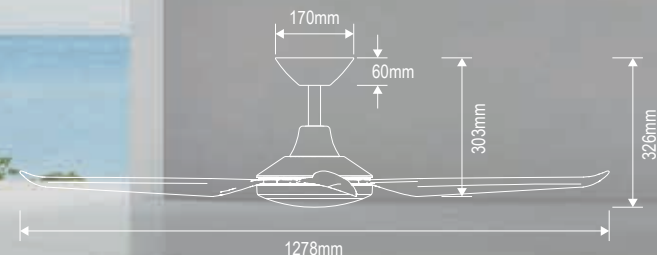

AXIS-48-L

| Item No. | Variants | | CCT | Wattage | Luminaire Wattage | Blade Pitch | Tropically Rated | Remote Control |
|------------------------|--------------|--------------|------|---------|-------------------|-------------|------------------|----------------|
| | Blk | Wht | | | | | | |
| MOTION-52-LIGHT | 60050 | 60051 | TRIO | 26W | 18W | 14.5° | Yes | Yes |

Accessories sold separately: Bluetooth Wall Control & Extension Rods.

Note: Do NOT install on a raked or sloped ceiling without the use of the optional 38° Ceiling Kit, as this will damage the receiver housed in the canopy.

Air Movement

Air Movement





Ceiling Fans

Hover 56

5 Blade 56" Ceiling Fan with no light

DC Motor
ABS Polymer motor, canopy and blades
Winter/Summer Function

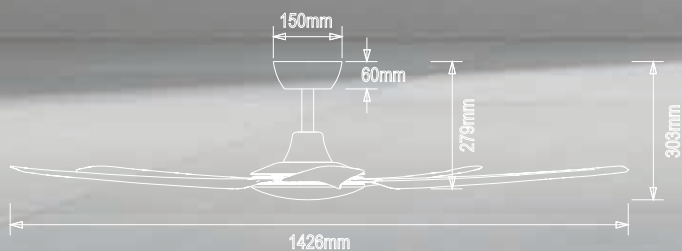

AXIS-48

| Item No. | Variants | | CCT | Wattage | Blade Pitch | Tropically Rated | Remote Control |
|-----------------|--------------|--------------|------|---------|-------------|------------------|----------------|
| | Blk | Wht | | | | | |
| HOVER-56 | 60060 | 60061 | TRIO | 26W | 14.5° | Yes | Yes |

Accessories sold separately: Bluetooth Wall Control & Extension Rods.

Note: Do NOT install on a raked or sloped ceiling without the use of the optional 38° Ceiling Kit, as this will damage the receiver housed in the canopy.



Ceiling Fans



Hover 56 Light

5 Blade 56" Ceiling Fan with light

DC Motor
ABS Polymer motor, canopy and blades
Winter/Summer Function
LED CCT Switchable Light

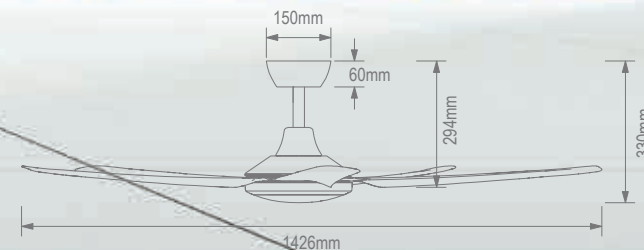

AXIS-48-L

| Item No. | Variants | | CCT | Wattage | Luminaire Wattage | Blade Pitch | Tropically Rated | Remote Control |
|-----------------------|--------------|--------------|------|---------|-------------------|-------------|------------------|----------------|
| | Blk | Wht | | | | | | |
| HOVER-56-LIGHT | 60070 | 60071 | TRIO | 26W | 18W | 14.5° | Yes | Yes |

Accessories sold separately: Bluetooth Wall Control & Extension Rods.

Note: Do NOT install on a raked or sloped ceiling without the use of the optional 38° Ceiling Kit, as this will damage the receiver housed in the canopy.

Air Movement

Air Movement



Fresco 52

4 Blade 52" Outdoor
IP66 Ceiling Fan with no light

DC Motor
ABS Polymer motor, canopy and blades
Winter/Summer Function

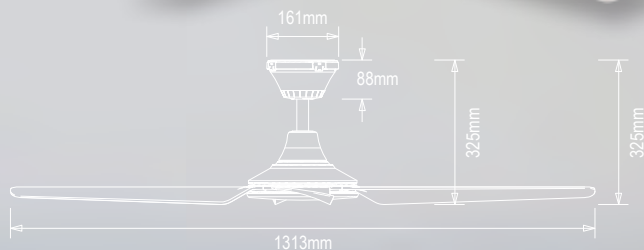

AXIS-48

| Item No. | Variants | | CCT | Wattage | Blade Pitch | IP Rating | Remote Control |
|------------------|--------------|--------------|------|---------|-------------|-----------|----------------|
| | Blk | Wht | | | | | |
| FRESCO-52 | 60080 | 60081 | TRIO | 26W | 14.5° | IP66 | Yes |

*Accessories sold separately: Bluetooth Wall Control & Extension Rods.

Note: Do NOT install on a raked or sloped ceiling without the use of the optional 38° Ceiling Kit, as this will damage the receiver housed in the canopy. *If 38° ceiling kit is used the fan will no longer be IP66.



Fresco 52 Light

4 Blade 52" Outdoor
IP66 Ceiling Fan with light

DC Motor
ABS Polymer motor, canopy and blades
Winter/Summer Function
LED CCT Switchable Light

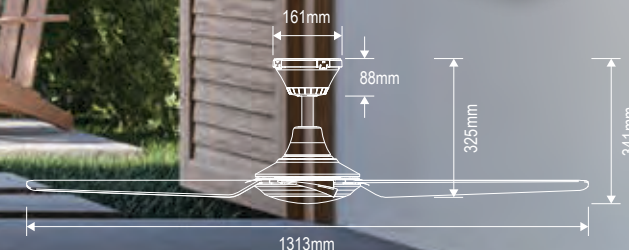
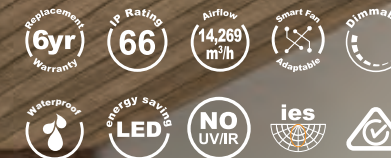

AXIS-48-L

| Item No. | Variants | | CCT | Wattage | Luminaire Wattage | Blade Pitch | IP Rating | Remote Control |
|------------------------|--------------|--------------|------|---------|-------------------|-------------|-----------|----------------|
| | Blk | Wht | | | | | | |
| FRESCO-52-LIGHT | 60090 | 60091 | TRIO | 26W | 18W | 14.5° | IP66 | Yes |

*Accessories sold separately: Bluetooth Wall Control & Extension Rods.

Note: Do NOT install on a raked or sloped ceiling without the use of the optional 38° Ceiling Kit, as this will damage the receiver housed in the canopy. *If 38° ceiling kit is used the fan will no longer be IP66.

Universal 38 Degree Ceiling Mount Kit (Only for raked ceilings)

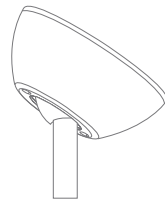

Only for raked ceiling
(180mm diameter canopy)

| Item No. | Variants | |
|----------|----------|-------|
| | Blk | Wht |
| CFA-CK1 | 60115 | 60114 |

Smart WIFI Module



| Item No. | Variant |
|----------|---------|
| CFA-SWM | 60124 |

Wall Controller

- Compatible with all Domus DC Ceiling fans.
- 9 speed options.
- Timer function for fan and light (1,2,3,8 hours).
- Reverse function
- Light On/Off Settings
- Light Dimming
- Colour Changing Technology function (CCT).
- Displays ambient room temperature in Celsius.
- White and Blue LED back light.



| Item No. | Variant |
|----------|---------|
| CFA-WC1 | 60110 |

Downrod 1



Suits all models except for FRESCO Series

Downrod 2 (To suit FRESCO ceiling fans only)



| Item No. | Variants | |
|----------|----------|-------|
| | Blk | Wht |
| CFA-DR1 | 60100 | 60101 |
| CFA-DR2* | 60105 | 60106 |

All rods are 900mm long.
*To suit Fresco Ceiling fans only.



Bolt Series

- Dual wattage option.
- Inbuilt LED driver included.
- Replaceable LED module.



BOLT-60

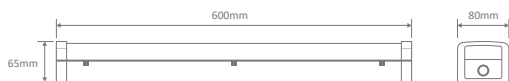

BOLT-120

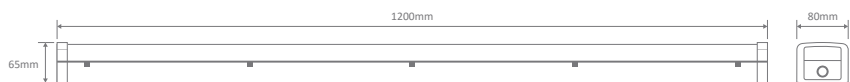

| Item No. | Variants | Wattage | IP Rating | CCT | Lumen Output | | |
|----------|----------|------------------------|-----------|------|------------------|---------------------|-------------|
| | | | | | Warm White 3000K | Neutral White 4000K | White 5700K |
| BOLT-60 | 66000 | 10W/12W 15W/17W/20W | 44 | TRIO | 810/1665lm | 900/1850lm | 900/1850lm |
| BOLT-120 | 66003 | 20W/25W 30W/36W/40W | 44 | TRIO | 1665/3420lm | 1850/3800lm | 1850/3800lm |



Bolt Emergency Series

Compliance: Fully compliant to AS/NZS 2293 standards
 Battery: LiFePO4 battery type, 6.4V, 7 Hour Charging Time, 1.5 Hours Discharging Time
 Battery Capacity: 1500 mAh at 0.2 CmA
 Emergency: Sustained
 Rated Duration: 120 Min
 Classification: CO: D50, C90: D32



BOLT-EM-60

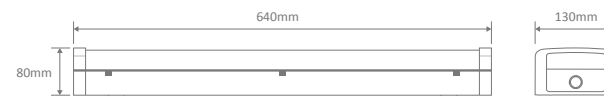

BOLT-EM-120

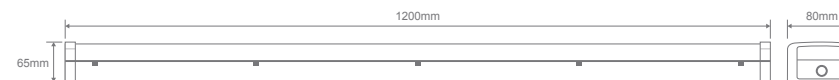

| Luminaire Classifications | Maximum Spacings (M) | Mounting Height (M) | | | | | | | | | | | | | | |
|---------------------------|----------------------|---------------------|------|------|------|------|------|------|------|------|------|------|------|------|------|------|
| | | Mounting Height (M) | | | | | | | | | | | | | | |
| | | 2.1 | 2.4 | 2.7 | 3 | 3.3 | 3.6 | 4 | 4.5 | 5 | 6 | 7 | 8 | 9 | 10 | 15 |
| CO-C180 | D50 | 18.0 | 18.7 | 19.4 | 20.1 | 20.7 | 21.2 | 21.8 | 22.5 | 23.2 | 24.2 | 24.9 | 25.4 | 25.7 | 25.9 | 23.7 |
| C90-C270 | D32 | 15.4 | 16.1 | 16.7 | 17.2 | 17.6 | 18.0 | 18.5 | 19.1 | 19.5 | 20.2 | 20.6 | 20.7 | 20.6 | 20.3 | 14.6 |

| Item No. | Variants | Wattage | IP Rating | CCT | Lumen Output | | |
|-------------|----------|------------------------|-----------|------|------------------|---------------------|-------------|
| | | | | | Warm White 3000K | Neutral White 4000K | White 5700K |
| BOLT-60-EM | 66007 | 10W/12W 15W/17W/20W | 44 | TRIO | 900/1800lm | 1000/2000lm | 1000/2000lm |
| BOLT-120-EM | 66006 | 20W/25W 30W/36W/40W | 44 | TRIO | 900/3600lm | 1000/4000lm | 1000/4000lm |



Bolt Slim

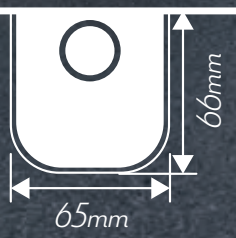

LED Battens



Bolt Slim Series

- Dual wattage option.
- Inbuilt LED driver included.
- Replaceable LED module.



BOLT-SLIM-60

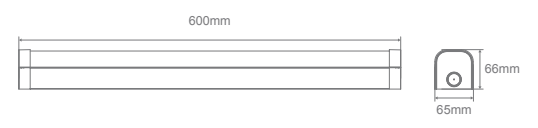

BOLT-SLIM-20

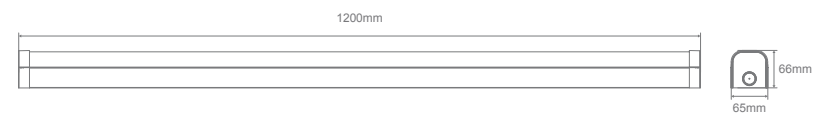

LED Battens

| Item No. | Variants | Wattage | IP Rating | CCT | Lumen Output | | |
|----------------------|--------------|-----------------|-----------|------|------------------|---------------------|-------------|
| | | | | | Warm White 3000K | Neutral White 4000K | White 5700K |
| BOLT-SLIM-60 | 66000 | 10W/13W/16W/20W | 44 | TRIO | 1450/2700lm | 1530/2900lm | 1520/2790lm |
| BOLT-SLIM-120 | 66003 | 25W/25W/35W/40W | 44 | TRIO | 2870/5445lm | 3020/5830lm | 3015/5625lm |



Hydro Weatherproof Series

- 130lm/W High Efficiency LED PCB.
- Dual wattage option.
- Inbuilt LED driver included.
- Replaceable LED module.
- DALI options available.
- Available in ON/OFF and DIM Sensor options.

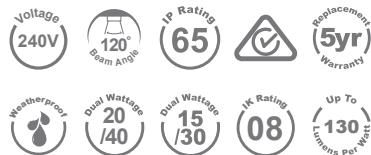

| Item No. | Variants | | | Wattage | IP Rating | CCT | Lumen Output | | |
|--------------------------|--------------|----------------|--------------|---------|-----------|------|------------------|---------------------|-------------|
| | Non-Dim | On/Off Sensor* | Dim Sensor* | | | | Warm White 3000K | Neutral White 4000K | White 5500K |
| HYDRO-60 | 66012 | 66028 | 66029 | 7.5/15W | 65 | TRIO | 980/1850lm | 980/1900lm | 950/1850lm |
| HYDRO-120 | 66017 | 66025 | 66026 | 15/30W | 65 | TRIO | 2350/4050lm | 2400/4250lm | 2400/4150lm |
| SENSOR-INT-01-REM | 66090 | 66091 | | | | | | | |

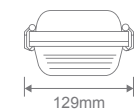

HYDRO-60

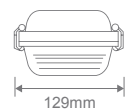

HYDRO-120

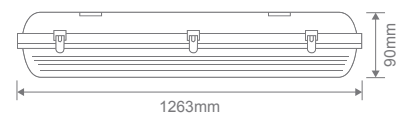
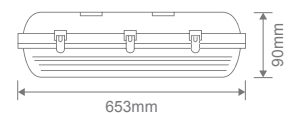

Hydro Emergency Weatherproof Series

- Compliance: Fully compliant to AS/NZS 2293 standards
- Battery: LiFePO4 battery type, 6.4V, 7 Hour Charging Time, 1.5 Hours Discharging Time
- Battery Capacity: 1500 mAh at 0.2 CmA
- Emergency: Sustained
- Rated Duration: 120 Min
- Classification: CO: D50, C90: D32
- DALI options available.
- ON/OFF and DIM Sensor options available.

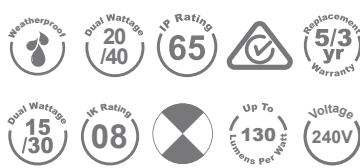

| Item No. | Variants | | | Wattage | IP Rating | CCT | Lumen Output | | |
|--------------------------|--------------|----------------|--------------|---------|-----------|------|------------------|---------------------|-------------|
| | Non-Dim | On/Off Sensor* | Dim Sensor* | | | | Warm White 3000K | Neutral White 4000K | White 5700K |
| HYDRO-60-EM | 66020 | 66030 | 66031 | 7.5/15W | 65 | TRIO | 950/1850lm | 980/1900lm | 950/1850lm |
| HYDRO-120-EM | 66021 | 66022 | 66023 | 15/30W | 65 | TRIO | 2350/4050lm | 2400/4250lm | 2400/4150lm |
| SENSOR-INT-01-REM | 66090 | 66091 | | | | | | | |



Internal ON/Off Sensor Remote control (Sold separately)



Dimmable Sensor Remote control (Sold separately)

Note: One remote control will operate unlimited sensors.





Park Series

- 130lm/W High Efficiency LED PCB
- Dual wattage option.
- Inbuilt LED driver included.
- Replaceable LED module.
- DALI options available.
- Available in ON/OFF and DIM Sensor options.

| Item No. | Variants | | | Wattage | IP Rating | CCT | Lumen Output | | |
|--------------------------|--------------|----------------|--------------|---------|-----------|------|------------------|---------------------|-------------|
| | Non-Dim | On/Off Sensor* | Dim Sensor* | | | | Warm White 3000K | Neutral White 4000K | White 5500K |
| PARK-60-DIFF | 66050 | 66051 | 66052 | 7.5/15W | 20 | TRIO | 980/1950lm | 980/1950lm | 980/1950lm |
| PARK-120-DIFF | 66053 | 66054 | 66055 | 15/30W | 20 | TRIO | 1950/3900lm | 1950/3900lm | 1950/3900lm |
| PARK-60-WG | 66060 | 66061 | 66062 | 7.5/15W | 20 | TRIO | 980/1950lm | 980/1950lm | 980/1950lm |
| PARK-120-WG | 66063 | 66064 | 66065 | 15/30W | 20 | TRIO | 1950/3900lm | 1950/3900lm | 1950/3900lm |
| SENSOR-INT-01-REM | 66090 | 66091 | | | | | | | |

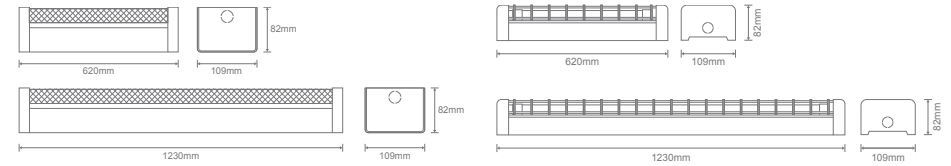
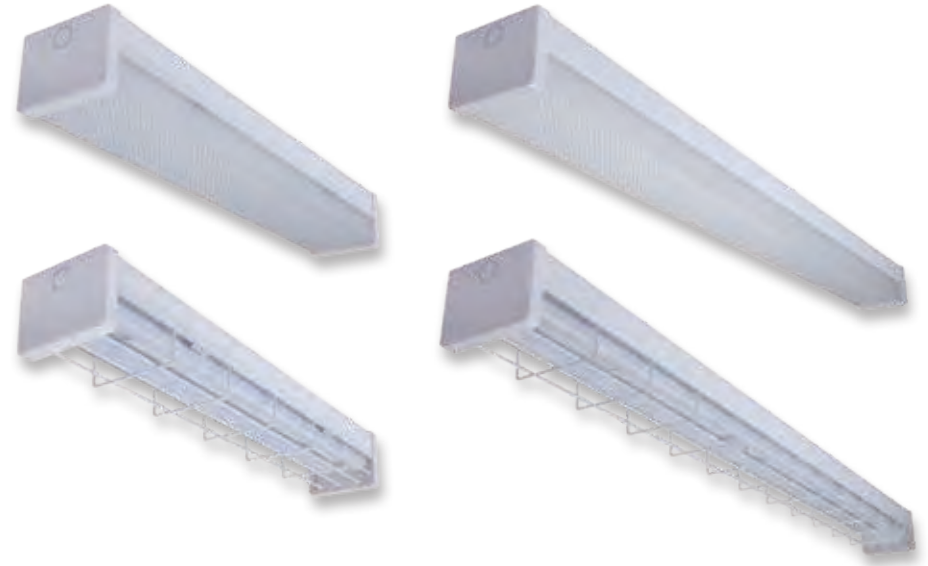

PARK-DIFF

PARK-WG

Park Emergency Series

Compliance: Fully compliant to AS/NZS 2293 standards
 Battery: LiFePO4 battery type, 6.4V, 7 Hour Charging Time, 1.5 Hours Discharging Time
 Battery Capacity: 1500 mAh at 0.2 CmA
 Emergency: Sustained
 Rated Duration: 120 Min
 Classification: CO: D50, C90: D32
 DALI options available.
 ON/OFF and DIM Sensor options available.



| Item No. | Variants | | | Wattage | IP Rating | CCT | Lumen Output | | |
|--------------------------|--------------|----------------|--------------|---------|-----------|------|------------------|---------------------|-------------|
| | Non-Dim | On/Off Sensor* | Dim Sensor* | | | | Warm White 3000K | Neutral White 4000K | White 5700K |
| PARK-60-DIFF-EM | 66020 | 66030 | 66031 | 7.5/15W | 20 | TRIO | 950/1850lm | 980/1900lm | 950/1850lm |
| PARK-120-DIFF-EM | 66021 | 66022 | 66023 | 15/30W | 20 | TRIO | 2350/4050lm | 2400/4250lm | 2400/4150lm |
| PARK-60-WG-EM | 66080 | 66081 | 66082 | 7.5/15W | 20 | TRIO | 950/1850lm | 980/1900lm | 950/1850lm |
| PARK-120-WG-EM | 66083 | 66084 | 66085 | 15/30W | 20 | TRIO | 2350/4050lm | 2400/4250lm | 2400/4150lm |
| SENSOR-INT-01-REM | 66090 | 66091 | | | | | | | |



Internal ON/Off Sensor Remote control (Sold separately)



Dimmable Sensor Remote control (Sold separately)

Note: One remote control will operate unlimited sensors.





Impact Series

- Dual wattage option.
- Inbuilt LED driver included.
- Replaceable LED module.
- Aluminium powder coated housing.
- Polycarbonate opal diffuser.
- Vandal proof.
- Ideal for railway and bus terminals, factories and tunnels.
- IK10 Rating.
- Comes complete with cable glands.



IMPACT-60

IMPACT-120



| Item No. | Variants | Wattage | IP Rating | CCT | Lumen Output | | |
|------------|----------|---------|-----------|------|---------------------|------------------------|----------------|
| | | | | | Warm White 3000K | Neutral White 4000K | White 5000K |
| IMPACT-60 | 66115 | 10/20W | 66 | TRIO | 2200lm | 2400lm | 2240lm |
| IMPACT-120 | 66116 | 20/40W | 66 | TRIO | 4800lm | 5000lm | 5000lm |



Waterproof Gland



Shadow Series



SHADOW-1LT
Polished Copper



Stainless Steel



Titanium Silver



Black



White

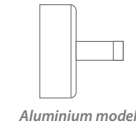
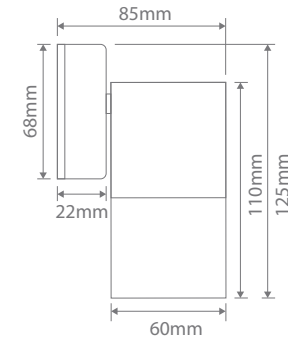

Aluminium models

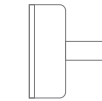

Stainless Steel
& Copper models

| Item No. | Variant | | | | | Wattage | IP Rating | Lamp |
|--------------------|--------------|--------------|--------------|--------------|--------------|---------|-----------|-----------|
| | Blk | Cop | Tsl | Sts | Wht | | | |
| SHADOW-1-WB | 49016 | 49019 | 49018 | 49020 | 49017 | 6W | 65 | GU10 TRIO |

Replacement Globe

| Item No. | Variants | Watt | Beam Angle | CCT | CRI | Lumen Output | | | Lifetime |
|----------------------|--------------|------|------------|------|-----|---------------------|------------------------|----------------|-----------|
| | | | | | | Warm White 3000K | Neutral White 4000K | White 6500K | |
| KEY-GU10-TRIO | 65112 | 6W | 60° | TRIO | ≥80 | 500lm | 550lm | 550lm | 15,000hrs |

Exterior

Exterior



Shadow Series



SHADOW-2LT
Polished Copper



Stainless Steel



Titanium Silver



Black



White

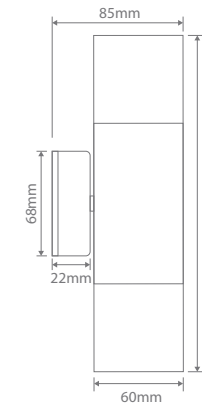
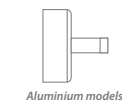

| Item No. | Variant | | | | | Wattage | IP Rating | Lamp |
|-------------|---------|-------|-------|-------|-------|---------|-----------|-----------|
| | Blk | Cop | Tsl | Sts | Wht | | | |
| SHADOW-2-WB | 49026 | 49029 | 49028 | 49030 | 49027 | 2x6W | 65 | GU10 TRIO |

Replacement Globe

| Item No. | Variants | Watt | Beam Angle | CCT | CRI | Lumen Output | | | Lifetime |
|---------------|----------|------|------------|------|-----|------------------|---------------------|-------------|-----------|
| | | | | | | Warm White 3000K | Neutral White 4000K | White 6500K | |
| KEY-GU10-TRIO | 65112 | 6W | 60° | TRIO | ≥80 | 500lm | 550lm | 550lm | 15,000hrs |

Exterior

Exterior



Shadow Series

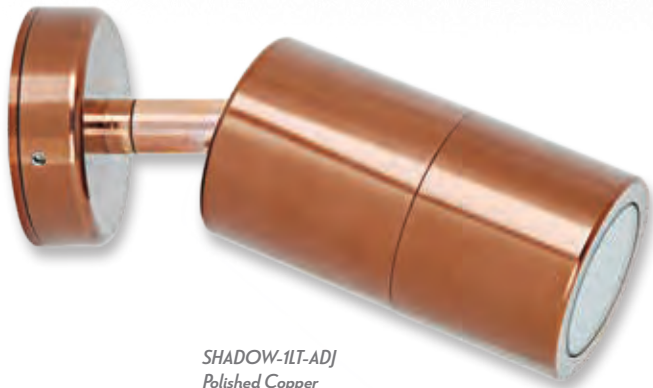

SHADOW-1LT-ADJ
Polished Copper



Stainless Steel



Titanium Silver

Black

White

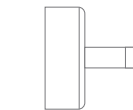
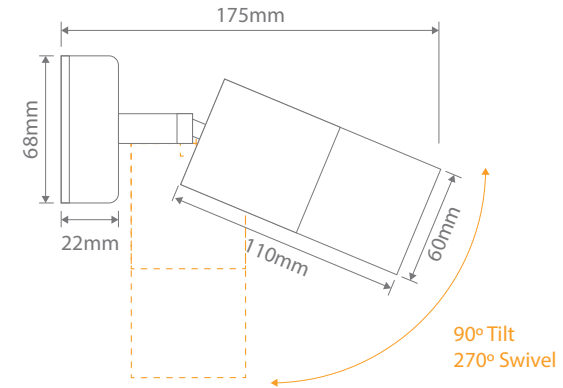

Aluminium models

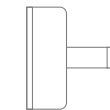

Stainless Steel
& Copper models

| Item No. | Variant | | | | | Wattage | IP Rating | Lamp |
|--------------|---------|-------|-------|-------|-------|---------|-----------|-----------|
| | Blk | Cop | Tsl | Sts | Wht | | | |
| SHADOW-1-ADJ | 49046 | 49049 | 49048 | 49050 | 49047 | 6W | 65 | GU10 TRIO |

Replacement Globe

| Item No. | Variants | Watt | Beam Angle | CCT | CRI | Lumen Output | | | Lifetime |
|---------------|----------|------|------------|------|-----|---------------------|------------------------|----------------|-----------|
| | | | | | | Warm White 3000K | Neutral White 4000K | White 6500K | |
| KEY-GU10-TRIO | 65112 | 6W | 60° | TRIO | ≥80 | 500lm | 550lm | 550lm | 15,000hrs |

Exterior

Exterior



Shadow Series



SHADOW-2LT-ADJ
Polished Copper



Stainless Steel



Titanium Silver

Black

White

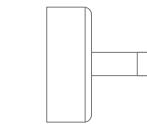
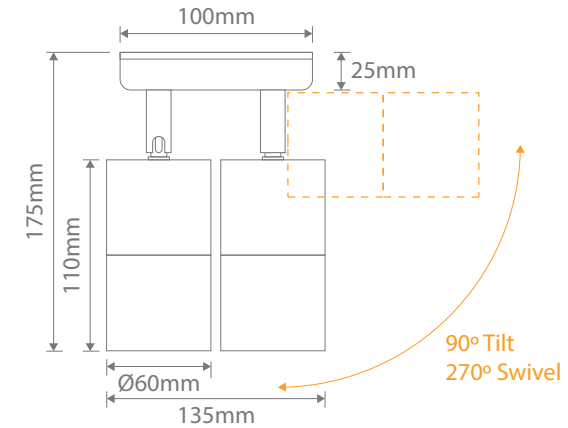

Aluminium models

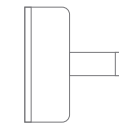

Stainless Steel
& Copper models

| Item No. | Variant | | | | | Wattage | IP Rating | Lamp |
|--------------|---------|-------|-------|-------|-------|---------|-----------|-----------|
| | Blk | Cop | Tsl | Sts | Wht | | | |
| SHADOW-2-ADJ | 49056 | 49059 | 49058 | 49060 | 49057 | 2x6W | 65 | GU10 TRIO |

Replacement Globe

| Item No. | Variants | Watt | Beam Angle | CCT | CRI | Lumen Output | | | Lifetime |
|---------------|----------|------|------------|------|-----|---------------------|------------------------|----------------|-----------|
| | | | | | | Warm White 3000K | Neutral White 4000K | White 6500K | |
| KEY-GU10-TRIO | 65112 | 6W | 60° | TRIO | ≥80 | 500lm | 550lm | 550lm | 15,000hrs |

Exterior

Exterior



LED Wall Lights



Finn-8 Series

- Cast Aluminium, powder coated.
- Inbuilt LED driver included.
- Fully dimmable with suitable dimmers.

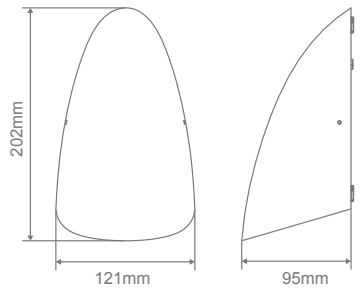

| Item No. | Variant | | | Wattage | IP Rating | CCT | Lumen Output | | |
|---------------|--------------|--------------|--------------|---------|-----------|------|------------------|---------------------|-------------|
| | Blk | Dgr | Wht | | | | Warm White 3000K | Neutral White 4000K | White 5700K |
| FINN-8 | 22655 | 22656 | 22657 | 8W | 65 | TRIO | 650lm | 680lm | 700lm |



LED Wall Lights



Zelda-18 Series

- Inbuilt LED driver included.
- Fully dimmable with suitable dimmers.

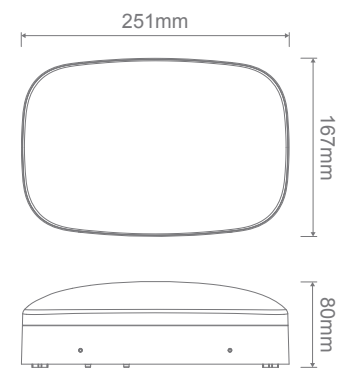

| Item No. | Variant | | Wattage | IP Rating | CCT | Lumen Output | | |
|-----------------|--------------|--------------|---------|-----------|------|------------------|---------------------|-------------|
| | Blk | Wht | | | | Warm White 3000K | Neutral White 4000K | White 5700K |
| ZELDA-18 | 22668 | 22669 | 18W | 65 | TRIO | 1600lm | 1730lm | 1850lm |



Exterior

Exterior



LED Wall Lights



Halo Series

- Aluminium fascia, polycarbonate backplate.
- Inbuilt LED driver included.
- Fully dimmable with suitable dimmers.

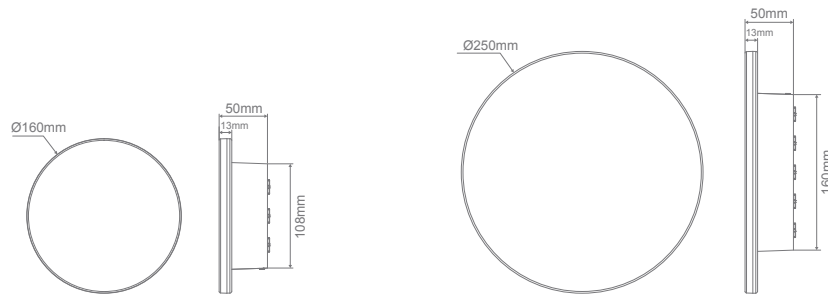

| Item No. | Variant | | Wattage | IP Rating | CCT | Lumen Output | | |
|----------|---------|-------|---------|-----------|------|------------------|---------------------|-------------|
| | Blk | Wht | | | | Warm White 3000K | Neutral White 4000K | White 5700K |
| HALO-8 | 22681 | 22682 | 8 | 65 | TRIO | 510lm | 565lm | 640lm |
| HALO-15 | 22683 | 22684 | 16W | 65 | TRIO | 1000lm | 1130lm | 1260lm |



LED Wall Lights



Livi Series

- Polycarbonate body.
- Inbuilt LED driver included.



LIVI-5-BLK



LIVI-8-WHT

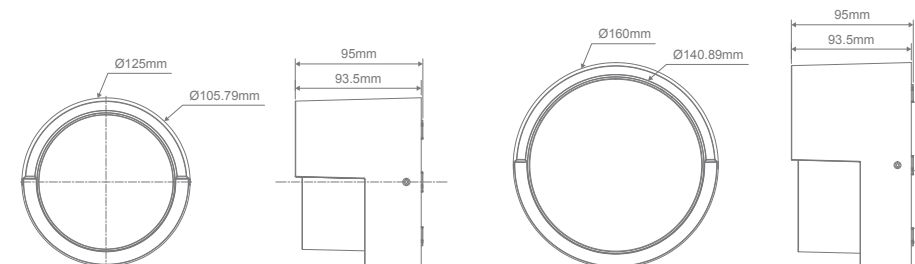

LIVI-5

LIVI-8

| Item No. | Variants | | | Wattage | IP Rating | CCT | Lumen Output | | |
|----------|----------|-------|-------|---------|-----------|------|------------------|---------------------|-------------|
| | Blk | Dgr | Wht | | | | Warm White 3000K | Neutral White 4000K | White 5700K |
| LIVI-5 | 22689 | 22690 | 22691 | 5W | 65 | TRIO | 340lm | 365lm | 390lm |
| LIVI-8 | 22692 | 22693 | 22694 | 8W | 65 | TRIO | 580lm | 600lm | 615lm |



LED Wall Lights



Miley 10 Series

- Choose to use with or without optional diffuser.



The use of the diffuser is optional (Included)

| Item No. | Variant | | Wattage | IP Rating | CCT | Lumen Output | | |
|-----------------|--------------|--------------|---------|-----------|------|------------------|---------------------|-------------|
| | Blk | Wht | | | | Warm White 3000K | Neutral White 4000K | White 5700K |
| MILEY-10 | 22664 | 22665 | 10W | 65 | TRIO | 350lm | 375lm | 400lm |



LED Wall Lights

Alpha Series

- Anodised Aluminium.
- Also available in powder coat black or white.

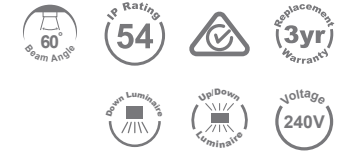

ALPHA-1-WB

ALPHA-2-WB

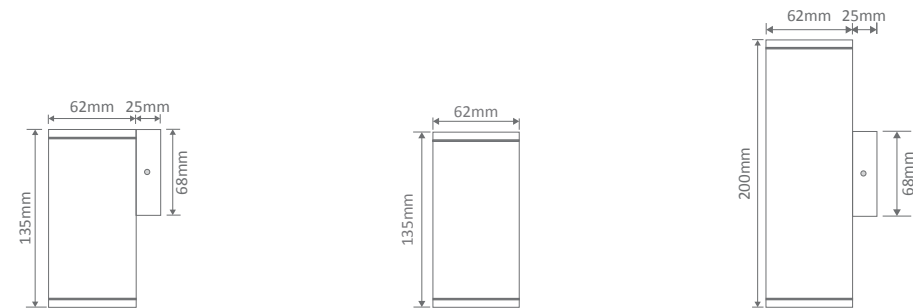

| Item No. | Variant | | | Wattage | IP Rating | CCT | Lumen Output | | |
|-------------------|--------------|--------------|--------------|---------|-----------|---------|--------------|---------|---------|
| | Blk | Alu | Wht | | | | 3000K | 4000K | 6500K |
| ALPHA-1-WB | 19128 | 19130 | 19129 | 1x6W | 54 | TRIO | 500lm | 550lm | 550lm |
| | 19388 | 19396 | 19391 | | | No Lamp | N/A | | |
| ALPHA-2-WB | 19131 | 19133 | 19132 | 2x6W | 54 | TRIO | 2x500lm | 2x550lm | 2x550lm |
| | 19794 | 19397 | 19797 | | | No Lamp | N/A | | |
| ALPHA-SM | 19134 | 19137 | 19136 | 1x6W | 54 | TRIO | 500lm | 550lm | 550lm |
| | 19808 | 19415 | 19811 | | | No Lamp | N/A | | |

Exterior

Exterior



LED Wall Lights



Piper 1 Series

- Complete with LED 10W PAR-30-TRIO lamp.
- Cast Aluminium, powder coated.

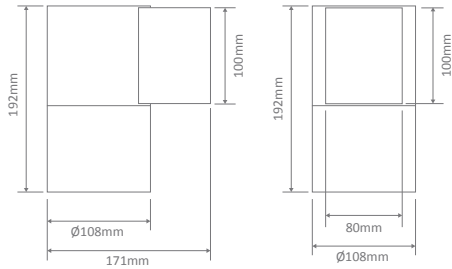

| Item No. | Variant | | Wattage | IP Rating | CCT | Lumen Output | | |
|------------------------|--------------|--------------|---------|-----------|------|--------------|--------|-------|
| | Blk | Wht | | | | 3000K | 4000K | 5000K |
| PIPER-PRO-1-RND | 49303 | 49304 | 1x10W | 65 | TRIO | 900lm | 1000lm | 950lm |



LED Wall Lights



Piper 1 Series

- Complete with LED 10W PAR-30-TRIO lamp.
- Cast Aluminium, powder coated.

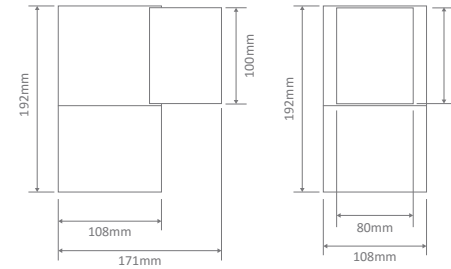

| Item No. | Variant | | Wattage | IP Rating | CCT | Lumen Output | | |
|------------------------|--------------|--------------|---------|-----------|------|--------------|--------|-------|
| | Blk | Wht | | | | 3000K | 4000K | 5000K |
| PIPER-PRO-1-SQR | 49300 | 49301 | 1x10W | 65 | TRIO | 900lm | 1000lm | 950lm |

Exterior

Exterior



Piper 2 Series

- Complete with LED 10W PAR-30-TRIO lamps.
- Cast Aluminium, powder coated.

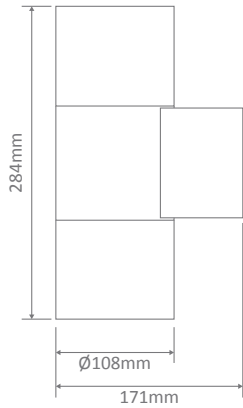
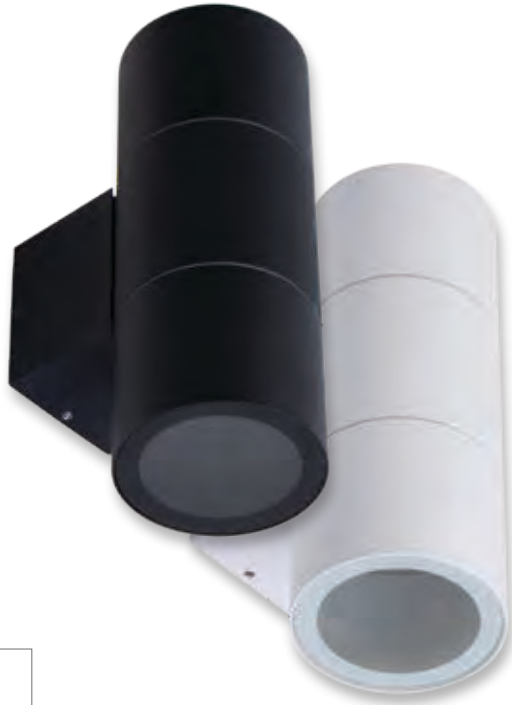

| Item No. | Variant | | Wattage | IP Rating | CCT | Lumen Output | | |
|------------------------|--------------|--------------|---------|-----------|------|--------------|--------|--------|
| | Blk | Wht | | | | 3000K | 4000K | 5000K |
| PIPER-PRO-2-RND | 49309 | 49310 | 2x10W | 65 | TRIO | 1800lm | 2000lm | 1900lm |



Piper 2 Series

- Complete with LED 10W PAR-30-TRIO lamps.
- Cast Aluminium, powder coated.

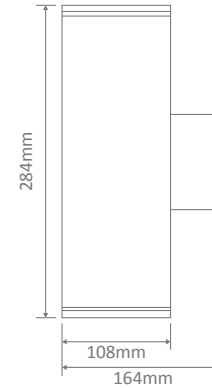

| Item No. | Variant | | Wattage | IP Rating | CCT | Lumen Output | | |
|------------------------|--------------|--------------|---------|-----------|------|--------------|--------|--------|
| | Blk | Wht | | | | 3000K | 4000K | 5000K |
| PIPER-PRO-2-SQR | 49306 | 49307 | 2x10W | 65 | TRIO | 1800lm | 2000lm | 1900lm |

Exterior

Exterior



LED Wall Lights

Whisper Series

- Tempered Opal Glass, cast Aluminium backing.
- Inbuilt LED driver included.

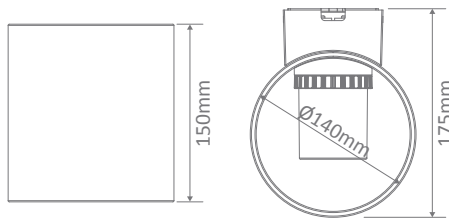

Exterior

WHISPER-6

| Item No. | Variant | | Wattage | IP Rating | CCT | Lumen Output |
|-----------|---------|-------|---------|-----------|-------|--------------|
| | Blk | Wht | | | | |
| WHISPER-6 | 19680 | 19678 | 10.5W | 65 | 3000K | 290lm |
| | 19681 | 19679 | | | 5000K | 340lm |



Dash Series

- Tempered Opal Glass, cast Aluminium backing.
- Inbuilt LED driver included.
- Available as Up/Down or Down only Luminaire.

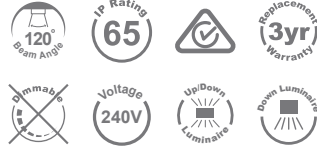

DASH-8-13-BLK



DASH-8-13-DGR



DASH-8-13-WHT

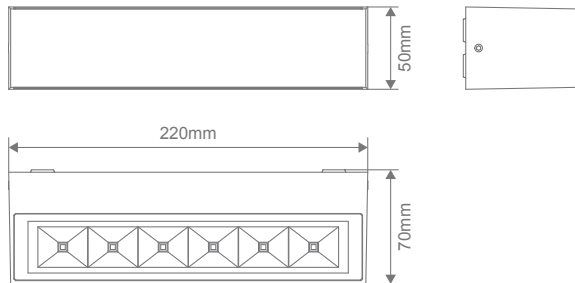

| Item No. | Variant | | | Wattage | IP Rating | CCT | Lumen Output |
|----------|---------|-------|-------|---------|-----------|-------|--------------|
| | Blk | Dgr | Wht | | | | |
| DASH-8 | 19900 | 19902 | 19904 | 8W | 65 | 3000K | 600lm |
| | 19901 | 19903 | 19905 | | | 5000K | 620lm |
| DASH-13 | 19942 | 19944 | 19946 | 13W | 65 | 3000K | 6100lm |
| | 19943 | 19945 | 19947 | | | 5000K | 10500lm |



DASH-8-WHT-3K

Exterior



LED Wall Lights

Sierra Series

- Cast Aluminium, powder coated.
- Adjustable integrated light angle slides.
- Inbuilt LED driver included.



SIERRA-12-RND

SIERRA-12-SQR

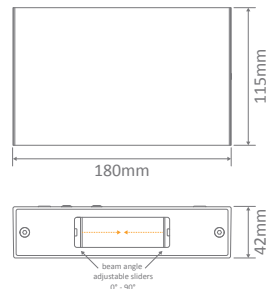
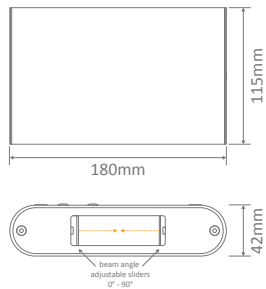

| Item No. | Variant | | | Wattage | IP Rating | CCT | Lumen Output |
|---------------|---------|-------|-------|---------|-----------|-------|--------------|
| | Blk | Dgr | Wht | | | | |
| SIERRA-12-RND | 19634 | 19630 | 19632 | 12W | 65 | 3000K | 400lm |
| | 19635 | 19631 | 19633 | | | 5000K | 450lm |
| SIERRA-12-SQR | 19640 | 19636 | 19638 | 12W | 65 | 3000K | 400lm |
| | 19641 | 19637 | 19639 | | | 5000K | 450lm |



Adjustable Integrated Slides

Exterior



LED Wall Lights

Bell Series

- Cast Aluminium, powder coated.
- Inbuilt LED driver included.



BELL-8

BELL-13

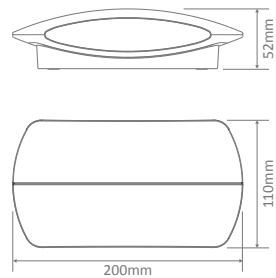
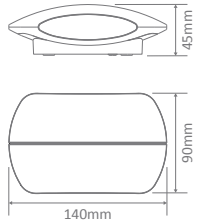

| Item No. | Variant | | | Wattage | IP Rating | CCT | Lumen Output |
|----------|---------|-------|-------|---------|-----------|-------|--------------|
| | Blk | Dgr | Wht | | | | |
| BELL-8 | 19370 | 19372 | 19374 | 8W | 65 | 3000K | 300lm |
| | 19371 | 19373 | 19375 | | | 5000K | 350lm |
| BELL-13 | 19376 | 19378 | 19380 | 13W | 65 | 3000K | 500lm |
| | 19377 | 19379 | 19381 | | | 5000K | 550lm |



BELL-8-DGR



Block Series

- Cast Aluminium, powder coated.
- Anti-glare internal reflector.
- Inbuilt LED driver included.

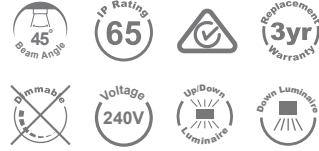

BLOCK-6



BLOCK-12

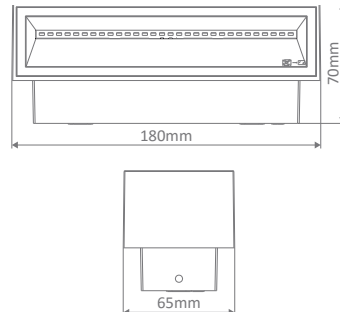
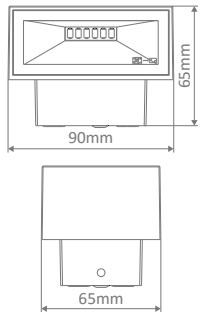

| Item No. | Variant | | | | Wattage | IP Rating | CCT | Lumen Output |
|----------|---------|-------|-------|-------|---------|-----------|-------|--------------|
| | Blk | Dgr | Slr | Wht | | | | |
| BLOCK-6 | 19544 | 19546 | 19570 | 19572 | 2x3W | 65 | 3000K | 500lm |
| | 19545 | 19547 | 19571 | 19573 | | | | 5000K |
| BLOCK-12 | 19548 | 19562 | 19576 | 19578 | 2x6W | 65 | 3000K | 950lm |
| | 19549 | 19563 | 19577 | 19579 | | | | 5000K |



Edge Series

- Cast Aluminium, powder coated.
- Inbuilt LED driver included.

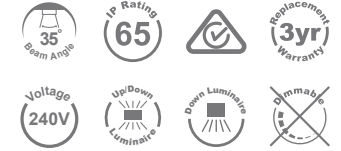

EDGE-4



EDGE-8

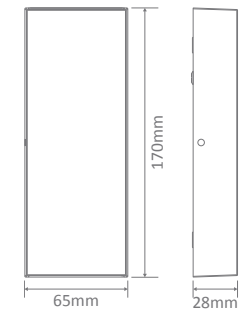
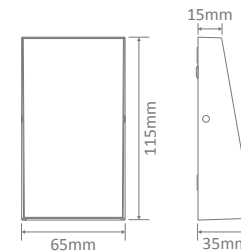

| Item No. | Variant | | | Wattage | IP Rating | CCT | Lumen Output |
|----------|---------|-------|-------|---------|-----------|-------|--------------|
| | Blk | Dgr | Wht | | | | |
| EDGE-4 | 19692 | 19694 | 19696 | 4W | 65 | 3000K | 150lm |
| | 19693 | 19695 | 19697 | | | | 5000K |
| EDGE-8 | 19684 | 19686 | 19688 | 8W | 65 | 3000K | 300lm |
| | 19685 | 19687 | 19689 | | | | 5000K |



LED Wall Lights



Dent Series

- Cast Aluminium, powder coated.

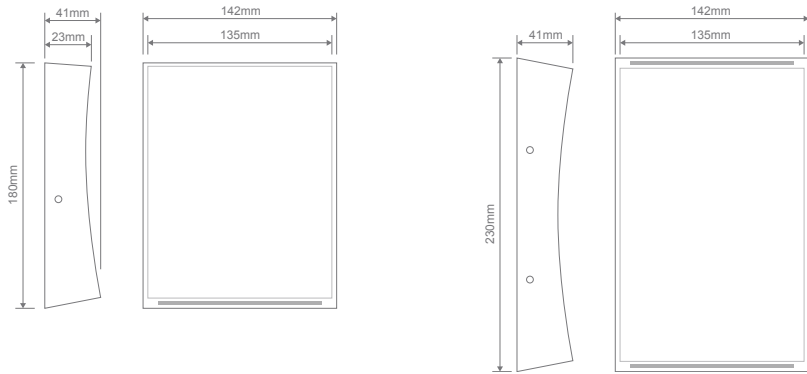
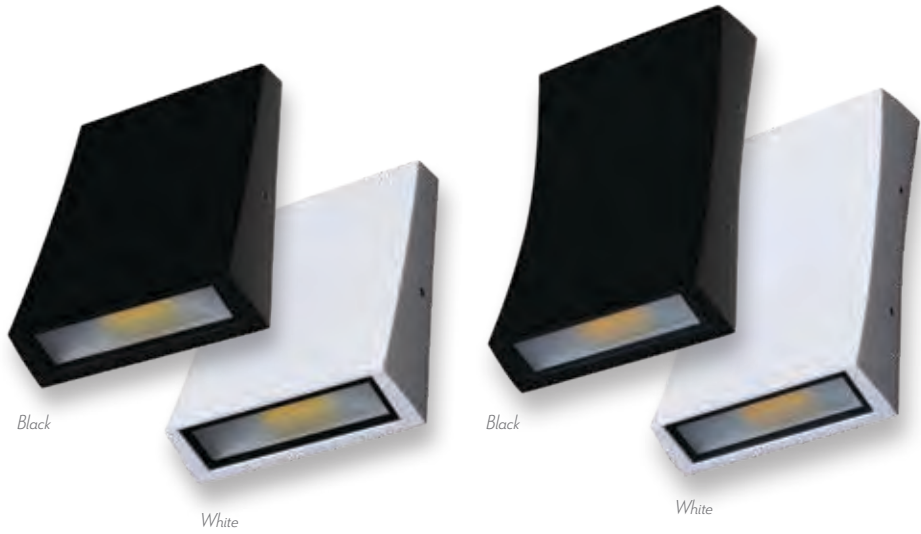
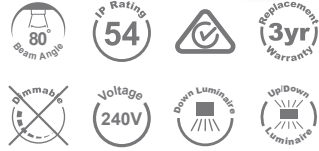

| Item No. | Variant | | Wattage | IP Rating | CCT | Lumen Output | | |
|----------|---------|-------|---------|-----------|------|--------------|-------|-------|
| | Blk | Wht | | | | 3000K | 4000K | 5000K |
| DENT-I | 19008 | 19009 | 6W | 54 | TRIO | 500lm | 550lm | 600lm |
| DENT-II | 19011 | 19012 | 2x6W | 54 | TRIO | 810lm | 860lm | 910lm |



DENT-II-WHT

Exterior



Kira Series

- Adjustable lens function, from a narrow 15° beam to a wide 60° beam angle.
- Tilt adjustable head in a Black, Dark Grey or White powder coated frame.



60° to 15° Beam Angle Variation

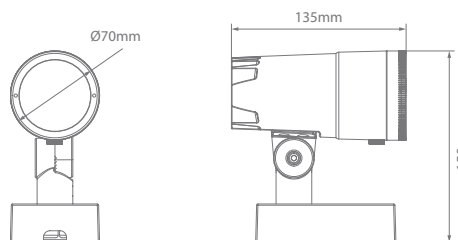

| Item No. | Variant | | | Wattage | IP Rating | CCT | Lumen Output |
|-------------|---------|-------|-------|---------|-----------|-------|--------------|
| | Blk | Dgr | Wht | | | | |
| KIRA-11-ADJ | 20264 | 20268 | 20266 | 11W | 65 | 3000K | 450lm |
| | 20265 | 20269 | 20267 | | | 5000K | 470lm |



Casa Series



- Featuring a Black, White or Dark Grey powder coated Aluminium frame with an opal diffuser or clear diffuser with internal louvres.



CASA



CASA-LOUVRE

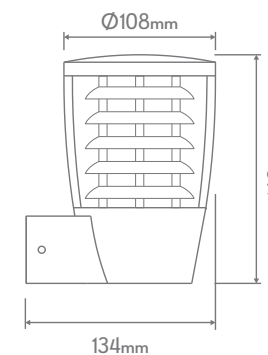
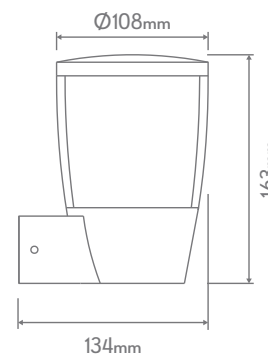

| Item No. | Variant | | | Wattage | IP Rating | Lamp Base | Requires |
|-------------|---------|-------|-------|-------------|-----------|-----------|----------------------------|
| | Blk | Dgr | Wht | | | | |
| CASA | 10713 | 10717 | 10716 | 25W LED Max | 54 | E27 | 1xE27 Globe (Not Included) |
| CASA-LOUVRE | 10747 | 10751 | 10750 | | | | |

Exterior



Claro Series

- Black or Dark Grey powder coated Aluminium frame

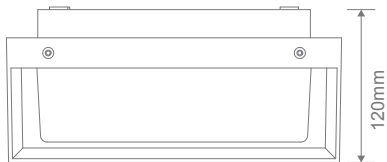
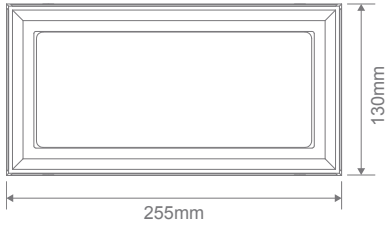

| Item No. | Variant | | Wattage | IP Rating | Lamp Base | Requires |
|----------|---------|-------|-------------|-----------|-----------|----------------------------|
| | Blk | Dgr | | | | |
| CLARO | 19890 | 19891 | 25W LED Max | 65 | E27 | 1xE27 Globe (Not Included) |
| | | | | | | |



Como Series

- Black or Dark Grey powder coated Aluminium frame, with an opal glass enclosure to the LED module behind.

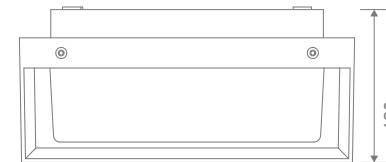
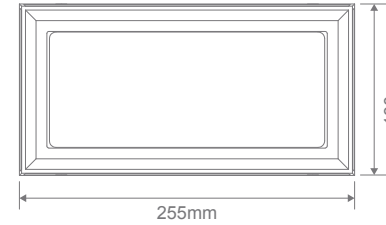

| Item No. | Variant | | Wattage | IP Rating | CCT | Lumen Output |
|----------|---------|-------|---------|-----------|-------|--------------|
| | Blk | Dgr | | | | |
| COMO-6 | 19882 | 19884 | 6W | 65 | 3000K | 420lm |
| | 19883 | 19885 | | | 5000K | 440lm |

Exterior

Exterior



York Series



- Cast Aluminium, powder coated, opal glass diffuser.
- Inbuilt LED driver included.



YORK-7

YORK-12

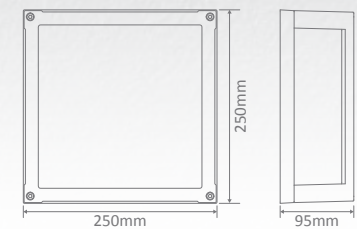

| Item No. | Variant | | | Wattage | IP Rating | CCT | | Lumen Output |
|----------|---------|-------|-------|---------|-----------|-------|-------|--------------|
| | Blk | Dgr | Wht | | | 3000K | 5000K | |
| YORK-7 | 19648 | 19644 | 19646 | 7W | 65 | 3000K | 350lm | |
| | 19649 | 19645 | 19647 | | | 5000K | 400lm | |
| YORK-12 | 19654 | 19650 | 19652 | 12W | 65 | 3000K | 800lm | |
| | 19655 | 19651 | 19653 | | | 5000K | 850lm | |

YORK-12-BLK

Exterior



LED Step Lights

Zone Series



- Injection moulded polycarbonate body.
- Inbuilt LED driver included.
- Clear and frosted tempered glass fascia.



ZONE-2

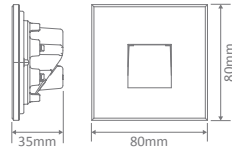

Cutout: ϕ 68mm



ZONE-4

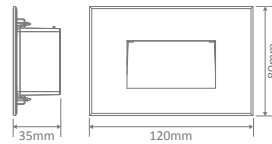

Cutout: 114mm x 68mm



ZONE-5

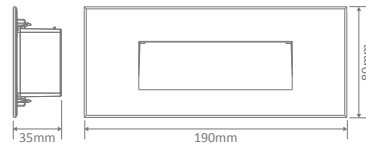

Cutout: 160mm x 68mm

| Item No. | Variant | Wattage | IP Rating | CCT | Lumen Output |
|----------|---------|---------|-----------|-------|--------------|
| ZONE-2 | 19720 | 2W | 65 | 3000K | 70lm |
| | 19721 | | | 5000K | 80lm |
| ZONE-4 | 19722 | 4W | 65 | 3000K | 160lm |
| | 19723 | | | 5000K | 180lm |
| ZONE-5 | 19724 | 5W | 65 | 3000K | 280lm |
| | 19725 | | | 5000K | 320lm |



ZONE-4

Exterior



LED Step Lights

Zac Series



- Cast Aluminium, powder coated.
- Inbuilt LED driver included.
- Comes c/w mounting box.



ZAC-4-RND

ZAC-4-SQR

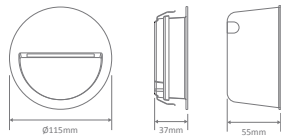

Cutout without recessed box: (Ø) 100mm
Cutout with recessed box: (Ø) 110mm

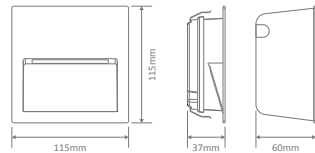

Cutout without recessed box: (Ø) 100mm
Cutout with recessed box: (L) 110mm x (H) 110mm

240V

| Item No. | Variant | | | | Wattage | IP Rating | CCT | Lumen Output |
|-----------|---------|-------|-------|-------|---------|-----------|-------|--------------|
| | Blk | Dgr | Slr | Wht | | | | |
| ZAC-4-RND | 19727 | 19729 | 19731 | 19733 | 4W | 65 | 3000K | 200lm |
| | 19728 | 19730 | 19732 | 19734 | | | 5000K | 250lm |
| ZAC-4-SQR | 19735 | 19737 | 19739 | 19741 | 4W | 65 | 3000K | 200lm |
| | 19736 | 19738 | 19740 | 19742 | | | 5000K | 250lm |

12V

| Item No. | Variant | | | | Wattage | IP Rating | CCT | Lumen Output |
|---------------|---------|-------|-------|-------|---------|-----------|-------|--------------|
| | Blk | Dgr | Slr | Wht | | | | |
| ZAC-4-12V-RND | 19770 | 19772 | 19774 | 19776 | 4W | 65 | 3000K | 200lm |
| | 19771 | 19773 | 19775 | 19777 | | | 5000K | 250lm |
| ZAC-4-12V-SQR | 19778 | 19780 | 19782 | 19784 | 4W | 65 | 3000K | 200lm |
| | 19779 | 19781 | 19783 | 19785 | | | 5000K | 250lm |



ZAC-4-SQR-DGR



Exterior



LED Step Lights

Zac Series



- Cast Aluminium, powder coated.
- Inbuilt LED driver included.
- Comes c/w mounting box.

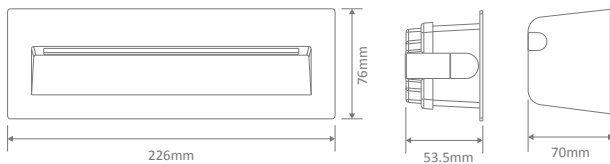

Cutout without recessed box: (L) 210mm x (H) 60mm
 Cutout with recessed box: (L) 220mm x (H) 70mm

240V

| Item No. | Variant | | | | Wattage | Voltage | IP Rating | CCT | Lumen Output |
|----------|---------|-------|-------|-------|---------|---------|-----------|-------|--------------|
| | Blk | Dgr | Slr | Wht | | | | | |
| ZAC-8 | 19760 | 19762 | 19764 | 19766 | 8W | 240V | 65 | 3000K | 300lm |
| | 19761 | 19763 | 19765 | 19767 | | | | 5000K | 350lm |

12V

| Item No. | Variant | | | | Wattage | Voltage | IP Rating | CCT | Lumen Output |
|-----------|---------|-------|-------|-------|---------|---------|-----------|-------|--------------|
| | Blk | Dgr | Slr | Wht | | | | | |
| ZAC-8-12V | 19786 | 19788 | 19790 | 19792 | 8W | 12V | 65 | 3000K | 300lm |
| | 19787 | 19789 | 19791 | 19793 | | | | 5000K | 350lm |

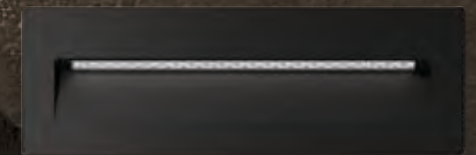
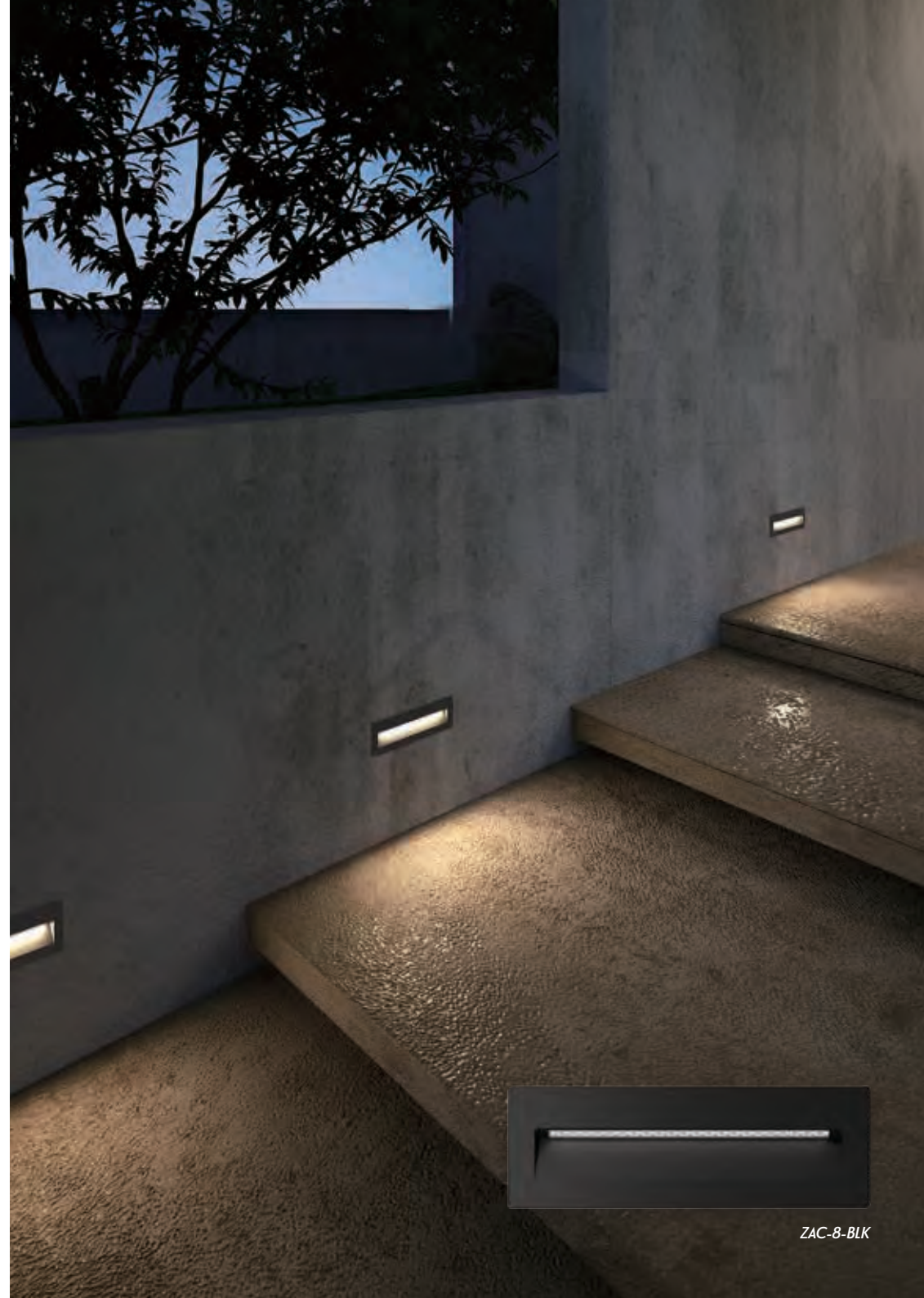

ZAC-8-BLK

Exterior



LED Step Lights

Zeke-9 Series

- Cast Aluminium, powder coated.
- Inbuilt LED driver included.



ZEKE-9-RND

ZEKE-9-SQR

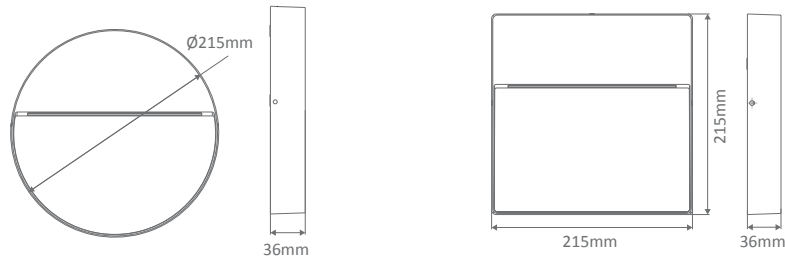

240V

| Item No. | Variant | | | | Wattage | Voltage | IP Rating | CCT | Lumen Output |
|------------|---------|-------|-------|-------|---------|---------|-----------|-------|--------------|
| | Blk | Dgr | Slr | Wht | | | | | |
| ZEKE-9-RND | 19514 | 19488 | 19486 | 19506 | 9W | 240V | 65 | 3000K | 800lm |
| | 19515 | 19489 | 19487 | 19507 | | | | 5000K | 900lm |
| ZEKE-9-SQR | 19516 | 19492 | 19490 | 19508 | 9W | 240V | 65 | 3000K | 800lm |
| | 19517 | 19493 | 19491 | 19509 | | | | 5000K | 900lm |

12V

| Item No. | Variant | | | | Wattage | Voltage | IP Rating | CCT | Lumen Output |
|----------------|---------|-------|-------|-------|---------|---------|-----------|-------|--------------|
| | Blk | Dgr | Slr | Wht | | | | | |
| ZEKE-9-12V-RND | 19870 | 19866 | 19864 | 19868 | 9W | 12V | 65 | 3000K | 800lm |
| | 19871 | 19867 | 19865 | 19869 | | | | 5000K | 900lm |
| ZEKE-9-12V-SQR | 19878 | 19874 | 19872 | 19876 | 9W | 12V | 65 | 3000K | 800lm |
| | 19879 | 19875 | 19873 | 19877 | | | | 5000K | 900lm |



LED Step Lights

Zeke-4 Series

- Cast Aluminium, powder coated.
- Inbuilt LED driver included.



ZEKE-4-RND

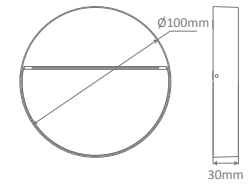

ZEKE-4-SQR

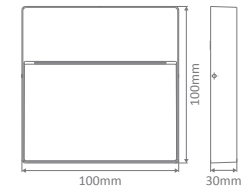

240V

| Item No. | Variant | | | | Wattage | Voltage | IP Rating | CCT | Lumen Output |
|------------|---------|-------|-------|-------|---------|---------|-----------|-------|--------------|
| | Blk | Dgr | Slr | Wht | | | | | |
| ZEKE-4-RND | 19526 | 19702 | 19700 | 19704 | 4W | 240V | 65 | 3000K | 300lm |
| | 19527 | 19703 | 19701 | 19705 | | | | 5000K | 350lm |
| ZEKE-4-SQR | 19528 | 19708 | 19706 | 19710 | 4W | 240V | 65 | 3000K | 300lm |
| | 19529 | 19709 | 19707 | 19711 | | | | 5000K | 350lm |

12V

| Item No. | Variant | | | | Wattage | Voltage | IP Rating | CCT | Lumen Output |
|----------------|---------|-------|-------|-------|---------|---------|-----------|-------|--------------|
| | Blk | Dgr | Slr | Wht | | | | | |
| ZEKE-4-12V-RND | 19846 | 19842 | 19840 | 19844 | 4W | 12V | 65 | 3000K | 300lm |
| | 19847 | 19843 | 19841 | 19845 | | | | 5000K | 350lm |
| ZEKE-4-12V-SQR | 19854 | 19850 | 19848 | 19852 | 4W | 12V | 65 | 3000K | 300lm |
| | 19855 | 19851 | 19849 | 19853 | | | | 5000K | 350lm |

Exterior

Exterior



LED Step Lights

Zeke-8 Series



- Cast Aluminium, powder coated.
- Inbuilt LED driver included.

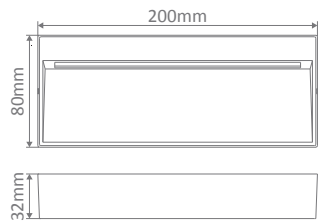

240V

| Item No. | Variant | | | | Wattage | Voltage | IP Rating | CCT | Lumen Output |
|----------|---------|-------|-------|-------|---------|---------|-----------|-------|--------------|
| | Blk | Dgr | Slr | Wht | | | | | |
| ZEKE-8 | 19542 | 19714 | 19712 | 19716 | 8W | 240V | 65 | 3000K | 500lm |
| | 19543 | 19715 | 19713 | 19717 | | | | 5000K | 550lm |

12V

| Item No. | Variant | | | | Wattage | Voltage | IP Rating | CCT | Lumen Output |
|------------|---------|-------|-------|-------|---------|---------|-----------|-------|--------------|
| | Blk | Dgr | Slr | Wht | | | | | |
| ZEKE-8-12V | 19862 | 19858 | 19856 | 19860 | 8W | 12V | 65 | 3000K | 500lm |
| | 19863 | 19859 | 19857 | 19861 | | | | 5000K | 550lm |



LED Step Lights

You Series



- Cast Aluminium powder coated.
- Inbuilt LED driver included.



YOU-RND



YOU-SQR

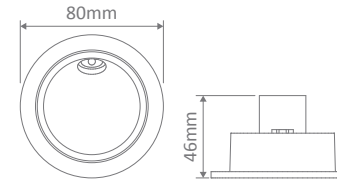

Depth without recessed box: (D) 46mm
Cutout without recessed box: (Ø) 70mm

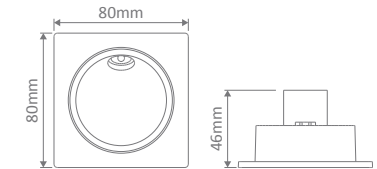

Depth without recessed box: (D) 46mm
Cutout without recessed box: (Ø) 70mm

Recessed Box (Included)

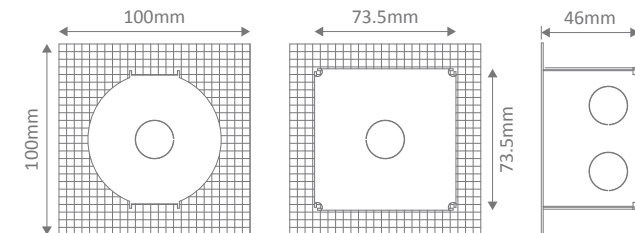

| Item No. | Variant | | Wattage | IP Rating | CCT | Lumen Output |
|-----------|---------|-------|---------|-----------|-------|--------------|
| | Blk | Wht | | | | |
| YOU-3-RND | 19989 | 19985 | 3W | 65 | 3000K | 200lm |
| | 19990 | 19986 | | | | 5000K |
| YOU-3-SQR | 19991 | 19987 | 3W | 65 | 3000K | 200lm |
| | 19992 | 19988 | | | | 5000K |

Exterior

Exterior



LED Floodlights



Blaze-Pro Series

- Cast Aluminium, powder coated.
- Multi wattage selectable.
- Colour temperature switchable.
- Unique anti-condensation breathing valve.
- Sensor adapter interface (PIR & PCELL).
- Corner bracket and pluggable sensors available (sold separately).



BLAZE-PRO-200

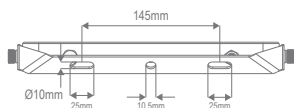
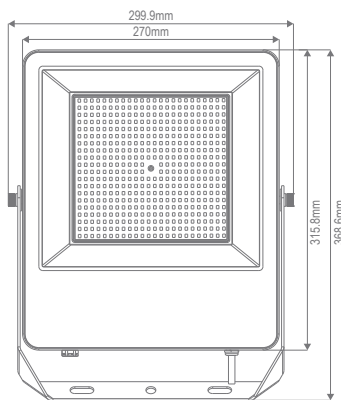
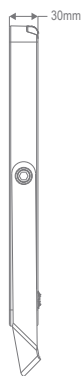

| Item No. | Variant | | IP Rating | CCT | Lumen Output | | | |
|---------------|---------|---------|-----------|------|--------------|---------|---------|---------|
| | Blk | Wht | | | 100W | 150W | 200W | |
| BLAZE-PRO-200 | 19920 | 19921 | 66 | TRIO | 3000K | 11840lm | 12780lm | 12720lm |
| | | | | | | 4000K | 17060lm | 18720lm |
| | 3000K | 21970lm | | | 24380lm | 23470lm | | |
| | | 4000K | | | | | | |
| | 5500K | | | | | | | |
| | | | | | | | | |



LED Floodlights



BLAZE-PRO-100



| Item No. | Variant | | IP Rating | CCT | Lumen Output | | | |
|---------------|---------|---------|-----------|------|--------------|---------|--------|--------|
| | Blk | Wht | | | 50W | 70W | 100W | |
| BLAZE-PRO-100 | 19918 | 19919 | 66 | TRIO | 3000K | 6040lm | 6510lm | 6450lm |
| | | | | | | 4000K | 8100lm | 8950lm |
| | 3000K | 10750lm | | | 12150lm | 12150lm | | |
| | | 4000K | | | | | | |
| | 5500K | | | | | | | |
| | | | | | | | | |

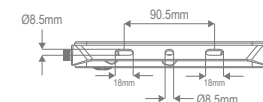
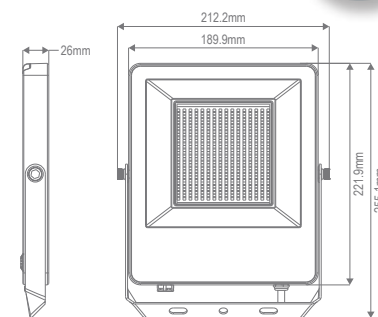

BLAZE-PRO-50



| Item No. | Variants | | IP Rating | CCT | Lumen Output | | | |
|--------------|----------|--------|-----------|------|--------------|--------|--------|--------|
| | Blk | Wht | | | 20W | 30W | 50W | |
| BLAZE-PRO-50 | 19916 | 19917 | 66 | TRIO | 3000K | 2250lm | 2360lm | 2380lm |
| | | | | | | 4000K | 3230lm | 3230lm |
| | 3000K | 5060lm | | | 5060lm | 5360lm | | |
| | | 4000K | | | | | | |
| | 5500K | | | | | | | |
| | | | | | | | | |

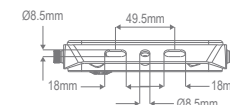
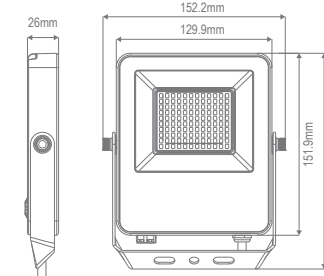



Blaze-Pro Accessories

Plug and Play PIR Sensor

A PIR (Passive Infrared) sensor, also known as a PIR motion sensor, is an electronic device used to detect the presence of humans or animals in its vicinity based on their emitted infrared radiation. PIR sensors are commonly used in security systems, automatic lighting systems, and various other applications that require motion detection. The optional sensor is a Plug-N-Play accessory that instantly converts the BLAZE-PRO floodlights into LED floodlights with sensor models.

Plug and Play Daylight Sensor

The optional BLAZE-PRO-PECELL Sensor is a Plug-N-Play accessory that instantly converts the BLAZE-PRO floodlights into LED floodlights with Photoelectric Cell Sensor models. This Sensor will automatically detect low light levels and turn on at dusk (or pre-selected setting) and turn off at dawn (or pre-selected setting) when light levels increase.



PIR Sensor Features (see Sensor Data Sheet)

| | |
|------------------------|----------------------|
| Left/Right Adjustment: | 90° |
| Up/Down Adjustment: | 180° |
| Sensor Control: | ON/OFF |
| Time Delay Settings: | 1, 3, 6 & 12Min |
| Sensitivity Settings: | 25%, 50%, 75% & 100% |
| Sensitivity Distance: | 2-8M |
| IP Rating: | IP65 |

PECELL Sensor Features (see Sensor Data Sheet)

| | |
|--------------------------|--------------------------|
| Voltage and current: | 5V DC, 10mA |
| Lux Level: | 10Lux/20Lux/50Lux/100Lux |
| IP Rating: | IP65 |
| Operating Temperature: | -30°C - 40°C |
| Installation height: | ≤8M |
| Remote Control Distance: | 0-8M |

| | |
|------------------|---------|
| Item No. | Variant |
| BLAZE-PRO-PIR | 19926 |
| BLAZE-PRO-PECELL | 19928 |



Blaze-Pro Accessories

Corner Mounting Bracket

360° Rotation



| | |
|---------------|---------|
| Item No. | Variant |
| BLAZE-PRO-BKT | 19923 |

Anti Condensation Valve

Also known as a condensation prevention valve or anti-sweat valve, is a device used to control or prevent condensation from forming on the surface of cold objects. It helps manage moisture buildup and reduce the potential for water damage, corrosion, or mould growth.

Release of Warm Air: Once the valve is open, it allows warm ambient air to flow into the area around the cold object. This warm air mixes with the cooler air in the vicinity of the surface, raising the temperature and preventing or reducing condensation. By mitigating condensation, anti-condensation valves help maintain the integrity and performance of equipment, minimise energy loss, reduce the risk of damage, and improve overall environmental conditions.

Multi-Wattage & Tri-Colour Switchable

Dip Switch Technology

Top switch changes wattage

Bottom switch changes colour temperature



Exterior

Exterior



LED Floodlights

Flash-20 Series

- Cast Aluminium, powder coated.
- Inbuilt LED driver included.
- Adjustable and Directional.

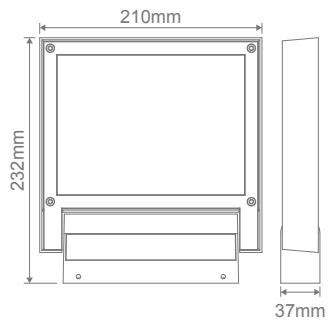

| Item No. | Variant | | | | Wattage | IP Rating | CCT | Lumen Output |
|----------|---------|-------|-------|-------|---------|-----------|-------|--------------|
| | Blk | Dgr | Slr | Wht | | | | |
| FLASH-20 | 19620 | 19564 | 19584 | 19586 | 20W | 65 | 3000K | 2000lm |
| | 19621 | 19565 | 19585 | 19587 | | | 5000K | 2200lm |



LED Spotlights

Elite Adjustable

- Anodised Aluminium.
- Adjustable and Directional.

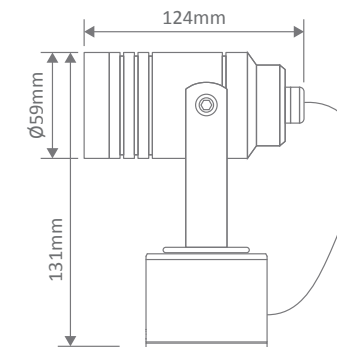

| Item No. | Variant Alu | Wattage | IP Rating | CCT | Lumen Output |
|-------------|-------------|---------|-----------|---------|--------------|
| ELITE-1-ADJ | 19408 | 6W | 54 | 3000K | 450lm |
| | 19409 | | | 5000K | 500lm |
| | 19416 | | | No Lamp | N/A |



LED Security Lights



Muro-Eco Series

- COB LED chip.
- Polycarbonate construction.
- Slimline sensor.
- Double Insulated
- Class II (No Earth Required)



MURO-ECO-10(S)-BLK

MURO-ECO-20(S)-WHT

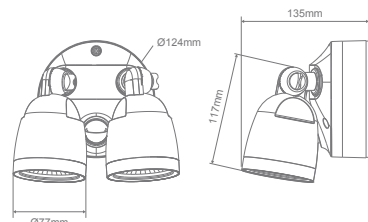
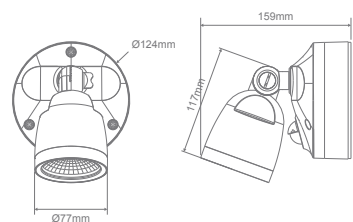

- Auxiliary terminal providing functionality for additional lights to be activated external from the spotlights (up to 250w load).
- Multiple sensor Muro-Eco fittings can be wired in parallel via auxiliary terminal.
- Built in manual override via a switching function process OR can be wired to a 3-position switch for manual operation.

| Item No. | Variant | | Wattage | IP Rating | CCT | Lumen Output | | |
|--------------|---------|-------|---------|-----------|------|------------------|---------------------|-------------|
| | Blk | Wht | | | | Warm White 3000K | Neutral White 4000K | White 5000K |
| MURO-ECO-10 | 25070 | 20571 | 10W | 65 | TRIO | 1000lm | 1050lm | 1000lm |
| MURO-ECO-10S | 25072 | 25073 | | | | | | |
| MURO-ECO-20 | 25074 | 25075 | 2x10W | 65 | TRIO | 2000lm | 2100lm | 2000lm |
| MURO-ECO-20S | 25076 | 25077 | | | | | | |



LED Security Lights



Muro-Max Series

- COB LED chip.
- Die-cast aluminium.
- Slimline sensor.



MURO-MAX-16(S)-BLK

MURO-MAX-32(S)-WHT

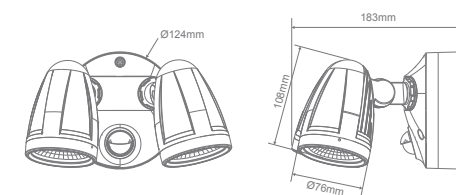
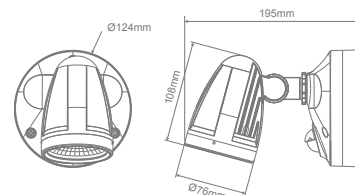

- Auxiliary terminal providing functionality for additional lights to be activated external from the spotlights (up to 250w load).
- Multiple sensor Muro-Eco fittings can be wired in parallel via auxiliary terminal.
- Built in manual override via a switching function process OR can be wired to a 3-position switch for manual operation.

| Item No. | Variant | | Wattage | IP Rating | CCT | Lumen Output | | |
|--------------|---------|-------|---------|-----------|------|------------------|---------------------|-------------|
| | Blk | Wht | | | | Warm White 3000K | Neutral White 4000K | White 5000K |
| MURO-MAX-16 | 25080 | 25081 | 16W | 65 | TRIO | 1700lm | 1800lm | 1600lm |
| MURO-MAX-16S | 25082 | 25083 | | | | | | |
| MURO-MAX-32 | 25084 | 25085 | 2x16W | 65 | TRIO | 3200lm | 3600lm | 3300lm |
| MURO-MAX-32S | 25086 | 25087 | | | | | | |



Muro-Pro Series

- COB LED chip.
- Cast Aluminium, powder coated.
- Inbuilt LED driver included.
- Adjustable and Directional.



MURO-PRO-15



MURO-PRO-30

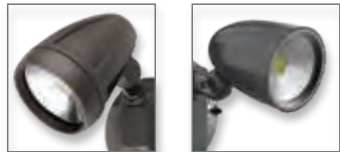

Dark Grey

Black



White

Black

| Item No. | Variant | | | Wattage | IP Rating | CCT | Lumen Output | | |
|--------------------|--------------|--------------|--------------|---------|-----------|------|------------------|---------------------|-------------|
| | Blk | Dgr | Wht | | | | Warm White 3000K | Neutral White 4000K | White 5000K |
| MURO-PRO-15 | 25053 | 25054 | 25055 | 15W | 54 | TRIO | 950lm | 1050lm | 1000lm |
| MURO-PRO-30 | 25059 | 25060 | 25061 | 2x15W | 54 | TRIO | 1900lm | 2100lm | 2000lm |



Muro-Pro Series

- COB LED chip.
- Cast Aluminium, powder coated.
- Inbuilt LED driver included.
- Adjustable and Directional.
- PIR detection sensor (Passive Infrared Sensor)



MURO-PRO-15S



MURO-PRO-30S



White

Dark Grey



Dark Grey

Black

| Item No. | Variant | | | Wattage | IP Rating | CCT | Lumen Output | | |
|---------------------|--------------|--------------|--------------|---------|-----------|------|------------------|---------------------|-------------|
| | Blk | Dgr | Wht | | | | Warm White 3000K | Neutral White 4000K | White 5000K |
| MURO-PRO-15S | 25056 | 25057 | 25058 | 15W | 44 | TRIO | 950lm | 1050lm | 1000lm |
| MURO-PRO-30S | 25062 | 25063 | 25064 | 2x15W | 44 | TRIO | 1900lm | 2100lm | 2000lm |



Elite Spike

- Adjustable and Directional.
- Available in Black and Anodised Aluminium.



ELITE-SPIKE-BLK

ELITE-SPIKE-ALU

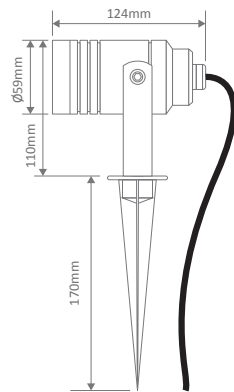

Water STOP Cable Joint

| Item No. | Variant | | | Wattage | IP Rating | CCT | Lumen Output | | |
|-------------|---------|-----|-------|---------|-----------|-----------|--------------|-------|-------|
| | Blk | Sts | Alu | | | | 3000K | 4000K | 6500K |
| ELITE-SPIKE | 19148 | N/A | 19147 | 6W | 54 | MR16 TRIO | 500lm | 550lm | 550lm |
| | 19666 | N/A | 19499 | | | | No Lamp | N/A | |

Requires: 12V DC Constant Voltage LED Driver - Wire in Parallel



Kira Spike

- Adjustable lens function
- Tilt adjustable head
- Black powder coated frame



Water STOP Cable Joint

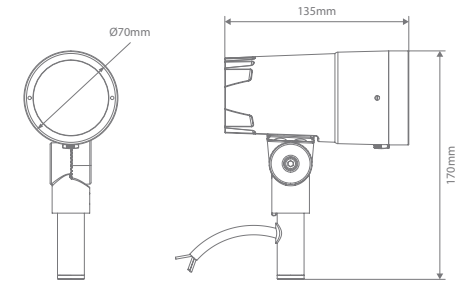

| Item No. | Variant | Wattage | IP Rating | CCT | Lumen Output |
|----------|---------|---------|-----------|-------|--------------|
| KIRA-6 | 20262 | 6W | 65 | 3000K | 300lm |
| | 20263 | | | 5000K | 310lm |

Requires: 12V DC Constant Voltage LED Driver - Wire in Parallel

60° to 15° Beam Angle Variation



Exterior

Exterior



Zoom Pro Series

- COB LED chip.
- Hood included.
- Adjustable and Directional.
- 12V/24V DC Input



5-12W 30W

ZOOM-PRO-5W

ZOOM-PRO-12W

ZOOM-PRO-30W

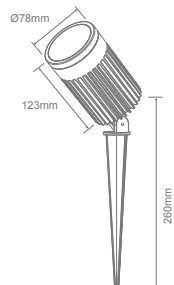
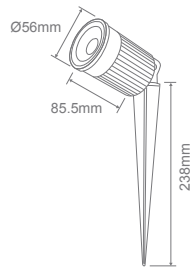
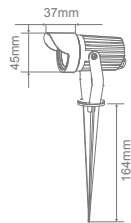

Water STOP Cable Joint

| Item No. | Variants | Wattage | IP Rating | CCT | Lumen Output | | |
|-------------|----------|---------|-----------|------|--------------|--------|--------|
| | | | | | 3000K | 4000K | 5000K |
| ZOOM-PRO-5 | 25702 | 5W | 65 | TRIO | 320lm | 360lm | 360lm |
| ZOOM-PRO-12 | 25706 | 12W | 65 | TRIO | 870lm | 980lm | 930lm |
| ZOOM-PRO-30 | 25709 | 30W | 65 | TRIO | 1930lm | 2070lm | 2010lm |

Requires: 12/24V DC Constant Voltage LED Driver - Wire in Parallel



Tree Bracket (5W only)

Variant: 25713

Exterior



Shadow Spike Series

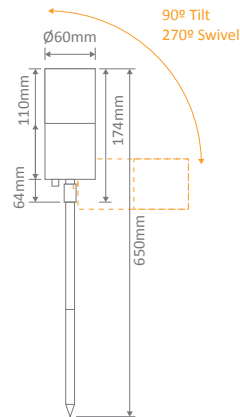

Water STOP Cable Joint

| Item No. | Variant | | Wattage | IP Rating | CCT | Lumen Output | | |
|--------------|---------|-------|---------|-----------|-----------|--------------|-------|-------|
| | Blk | Sts | | | | 3000K | 4000K | 6500K |
| SHADOW-1-GDN | 49073 | 49074 | 6W | 65 | MR16 TRIO | 500lm | 550lm | 550lm |

Requires: 12V DC Constant Voltage LED Driver - Wire in Parallel

Replacement Globe

| Item No. | Variants | Watt | Beam Angle | CCT | CRI | Lumen Output | | | Lifetime |
|---------------|----------|------|------------|------|-----|------------------|---------------------|-------------|-----------|
| | | | | | | Warm White 3000K | Neutral White 4000K | White 6500K | |
| KEY-MR16-TRIO | 65122 | 6W | 60° | TRIO | ≥80 | 500lm | 550lm | 550lm | 15,000hrs |



Shadow Path Series



SHADOW-ILT-PATH-SPIKE-BLK

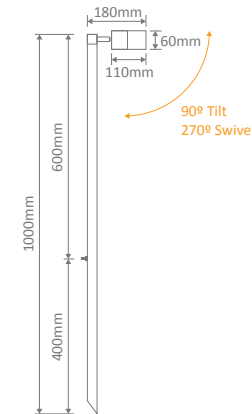

Water STOP Cable Joint

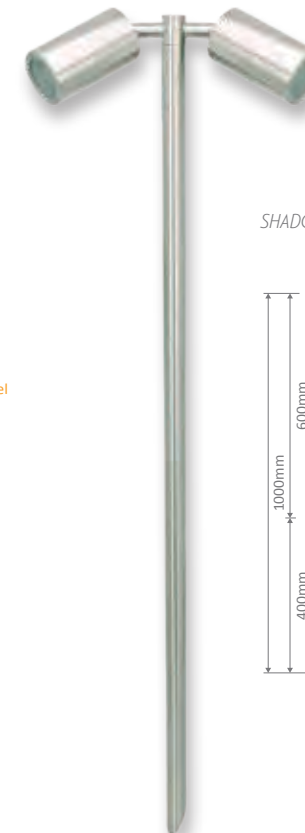

SHADOW-ILT-PATH-SPIKE-STs

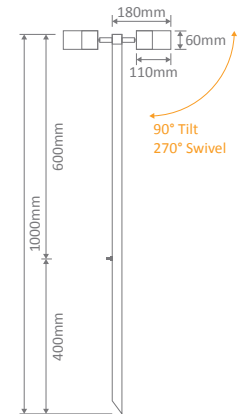

| Item No. | Variant | | Wattage | IP Rating | CCT | Lumen Output | | |
|--------------|---------|-------|---------|-----------|-----------|--------------|-------|-------|
| | Blk | Sts | | | | 3000K | 4000K | 6500K |
| SHADOW-1-PTH | 49083 | 49084 | 6W | 65 | MR16 TRIO | 500lm | 550lm | 550lm |
| SHADOW-2-PTH | 49088 | 49089 | 6W | 65 | MR16 TRIO | 500lm | 550lm | 550lm |

Requires: 12V DC Constant Voltage LED Driver - Wire in Parallel

Replacement Globe

| Item No. | Variants | Watt | Beam Angle | CCT | CRI | Lumen Output | | | Lifetime |
|---------------|----------|------|------------|------|-----|------------------|---------------------|-------------|-----------|
| | | | | | | Warm White 3000K | Neutral White 4000K | White 6500K | |
| KEY-MR16-TRIO | 65122 | 6W | 60° | TRIO | ≥80 | 500lm | 550lm | 550lm | 15,000hrs |

Exterior

Exterior



Dusk Path Series

- Complete with 4W LED G5.3 Bi-Pin Tri-Colour Lamp.
- Solid brass construction, designed for coastal areas.
- Available in durable black powder-coated Onyx finish.
- Available in Bronze (Weathered Brass).
- CRI 90
- Complete with 2 metre cable.



Water STOP Cable Joint

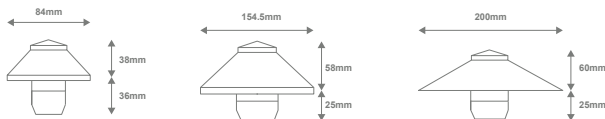

| Item No. | Variant | | Wattage | IP Rating | CCT | Lumen Output | | |
|-----------------|---------|-------|---------|-----------|------|--------------|-------|-------|
| | Blk | Brz | | | | 3000K | 4000K | 5000K |
| DUSK-PATH-450-S | 19108 | 19100 | 4W | 65 | TRIO | 330lm | 350lm | 330lm |
| DUSK-PATH-450-M | 19109 | 19101 | | | | | | |
| DUSK-PATH-450-L | 19110 | 19102 | | | | | | |
| DUSK-PATH-610-S | 19112 | 19104 | 4W | 65 | TRIO | 330lm | 350lm | 330lm |
| DUSK-PATH-610-M | 19113 | 19105 | | | | | | |
| DUSK-PATH-610-L | 19114 | 19106 | | | | | | |

Requires: 12V DC Constant Voltage LED Driver - Wire in Parallel

Replacement Globe

KEY-G5.3-TRIO 65124



Dusk Stick Series

- Complete with 4W LED G5.3 Bi-Pin Tri-Colour Lamp.
- Aluminium construction (Black Finish).
- Solid brass construction (Bronze Finish), designed for coastal areas.
- Available in durable black powder-coated Onyx finish.
- Available in Bronze (Weathered Brass).
- CRI 90.
- Complete with 2 metre cable.



Water STOP Cable Joint

| Item No. | Variant | | Wattage | IP Rating | CCT | Lumen Output | | |
|------------|---------|-------|---------|-----------|------|--------------|-------|-------|
| | Blk | Brz | | | | 3000K | 4000K | 5000K |
| DUSK-STICK | 19123 | 19122 | 4W | 54 | TRIO | 330lm | 350lm | 330lm |

Requires: 12V DC Constant Voltage LED Driver - Wire in Parallel

Replacement Globe

KEY-G5.3-TRIO 65124

Exterior

Exterior



Dusk Spike MR11

- Complete with 3W LED MR11 12V DC 3000K Lamp.
- Solid brass construction, designed for coastal areas.
- Available in durable black powder-coated Onyx finish.
- Available in Bronze (Weathered Brass).
- Complete with 2 metre cable.

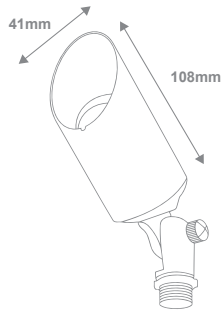

Water STOP Cable Joint



| Item No. | Variant | | Wattage | Beam Angle | IP Rating | CCT | Lumen Output | |
|------------------------|--------------|--------------|---------|------------|-----------|-------|--------------|-------|
| | Blk | Brz | | | | | 3000K | 6000K |
| DUSK-SPIKE-MR11 | 19120 | 19119 | 3W | 38° | 65 | 3000K | 240lm | 240lm |

Requires: 12V DC Constant Voltage LED Driver - Wire in Parallel

Replacement Globe

| Item No. | Variants | Watt | Beam Angle | CCT | CRI | Lumen Output | Lifetime |
|-------------------|------------------------------|------|------------|----------------|-----|--------------|-----------|
| KEY-MR11-3 | 65016 65017 | 3W | 38° | 3000K 6000K | ≥80 | 240lm | 15,000hrs |



Dusk Spike MR16

- Complete with 6W LED MR16 12V DC Tri-Colour Lamp.
- Solid brass construction, designed for coastal areas.
- Available in durable black powder-coated Onyx finish.
- Available in Bronze (Weathered Brass).
- Complete with 2 metre cable.

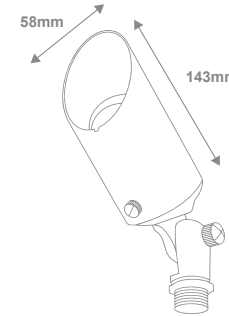

Water STOP Cable Joint



| Item No. | Variant | | Wattage | Beam Angle | IP Rating | CCT | Lumen Output | | |
|------------------------|--------------|--------------|---------|------------|-----------|------|--------------|-------|-------|
| | Blk | Brz | | | | | 3000K | 4000K | 6500K |
| DUSK-SPIKE-MR16 | 19117 | 19116 | 6W | 60° | 65 | TRIO | 500lm | 550lm | 550lm |

Requires: 12V DC Constant Voltage LED Driver - Wire in Parallel

Replacement Globe

| Item No. | Variants | Watt | Beam Angle | CCT | CRI | Lumen Output | | | Lifetime |
|----------------------|--------------|------|------------|------|-----|---------------------|------------------------|----------------|-----------|
| | | | | | | Warm White 3000K | Neutral White 4000K | White 6500K | |
| KEY-MR16-TRIO | 65122 | 6W | 60° | TRIO | ≥80 | 500lm | 550lm | 550lm | 15,000hrs |

Exterior

Exterior



Vivid Series



5 Pack DIY LED Deck Light kit, 5x0.6W, complete with plug and play cable and 12V DC LED Driver with flex and plug. 316 Stainless steel body with opal glass diffuser. Upgradable to maximum 10 lights by adding optional single deck light. Optional RF hand held dimmer (21100) also available upon request. Complete with 1 metre of cable per head. Note: 1.8m Flex and Plug to LED Driver. Driver to first light is 50cm, each light has 1m left and right, so max 2m spacing.

Single Colour 5 Pack Kit

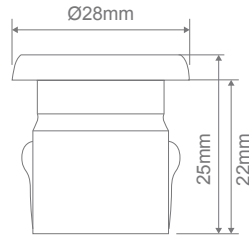

Cutout: Ø25mm

RGB Colour 5 Pack Kit



Colour controller with RF remote control. Multiple pre-set colour scenes as well as the option of choosing desired colour.



Single Head



Single head only to suit 5 Pack DIY LED Deck Light kit. Designed only to be used with kits to allow for extra lights to be added. 316 Stainless steel body with opal glass diffuser. Complete with 1 metre of cable per head. Must be used only with VIVID series as an additional accessory to increase the number of heads from 5 to a maximum of 10 heads.



Single Colour Dimming Controller



Single colour dimming controller and RF remote control to suit 5 Pack DIY LED Deck Light kit. Designed for use with Warm White and White 5 pack LED Deck light kits only. Must be used with single colour 5 Pack LED Deck Light Kits only.



| Item No. | Variant | Wattage | IP Rating | CCT | Lumen Output |
|-----------|---------|---------|-----------|-------|--------------|
| VIVID-5PK | 21101 | 5x0.6W | 67 | 3000K | 5x13lm |
| | 21102 | | | 5000K | 5x14lm |
| | 21103 | 5x0.6W | 67 | RGB | N/A |
| VIVID-1 | 21104 | 0.6W | 67 | 3000K | 13lm |
| | 21105 | | | 5000K | 14lm |
| | 21106 | | | RGB | N/A |
| VIVID-DIM | 21100 | N/A | N/A | N/A | N/A |

Exterior

Exterior



Emit 25 TRIO Series

Introducing the EMIT-25 LED Inground Light Series. The EMIT-25 is a mini inground light with a cutout of 19mm, ideal for lighting up features where minimalistic light effects are required. Featuring a 1W LED output, with a range of different fascia plates and metalware colour options. Choose from Round Open, Square Open, Eyelid and Halo fascias, as well as the multiway fascias available in 1WAY, 2WAY, 3WAY, and 4WAY. Metalware colour options range from Black, Stainless Steel, Antique Brass and Brushed Brass. Tri-Colour Selectable: Choose from 3000K Warm White, 4000K Neutral White and 5500K White colour temperature options. Functional with 12 and 24V DC Constant Voltage LED Drivers. Optional extra accessories such as narrow to medium Beam Angle Lens as well as Honeycomb and frosted diffusers are also available. Part of a family of different sizes to suit most inground lighting applications. Backed by a 5 Year Replacement Warranty.

Specification Features

| | | | | | | | | | |
|-----------------|---|----------|--------|------|------|------|------|------|------|
| Input Voltage: | 12/24V DC | | | | | | | | |
| Power (W): | 1W | | | | | | | | |
| IP rating (IP): | IP67 | | | | | | | | |
| IK Rating (IK): | IK10 | | | | | | | | |
| Lumens | RND OPEN | SQR OPEN | EYELID | 1WAY | 2WAY | 3WAY | 4WAY | HALO | RING |
| 3000K | 46 | 46 | 46 | 1.3 | 1.2 | 2.2 | 3.1 | 14 | 17 |
| 4000K | 51 | 51 | 51 | 1.3 | 1.2 | 2.2 | 3.1 | 14 | 17 |
| 5500K | 55 | 55 | 55 | 1.3 | 1.2 | 2.2 | 3.1 | 14 | 17 |
| LED type: | CREE | | | | | | | | |
| CCT: | 3000K-4000K-5500K (Changeable) | | | | | | | | |
| CRI: | ≥90 | | | | | | | | |
| Beam angle (°): | 19° - 36° - 60° (60° Standard) | | | | | | | | |
| Dimmable: | No | | | | | | | | |
| Lifespan (hrs): | 50,000hrs | | | | | | | | |
| Cutout (Ø): | Ø19mm Without Cannister Ø22mm With Cannister | | | | | | | | |

Requires 12 or 24V Constant Voltage LED Driver (Wire in Parallel)

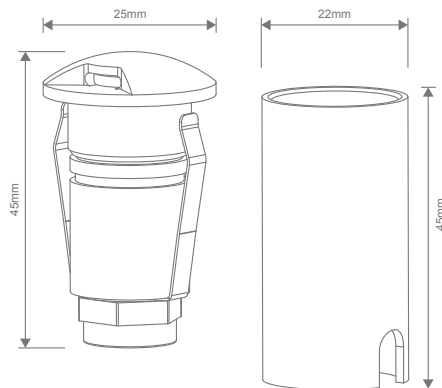

Honeycomb (Optional)



Opal Diffuser (Optional)



Water Stop Cable Joint



19° & 36° Lens (Optional)



Stainless Steel



EMIT-25-RO-STS EMIT-25-SO-STS EMIT-25-EYELID-STS EMIT-25-HALO-STS EMIT-25-RING-STS



EMIT-25-1WAY-STS EMIT-25-2WAY-STS EMIT-25-3WAY-STS EMIT-25-4WAY-STS

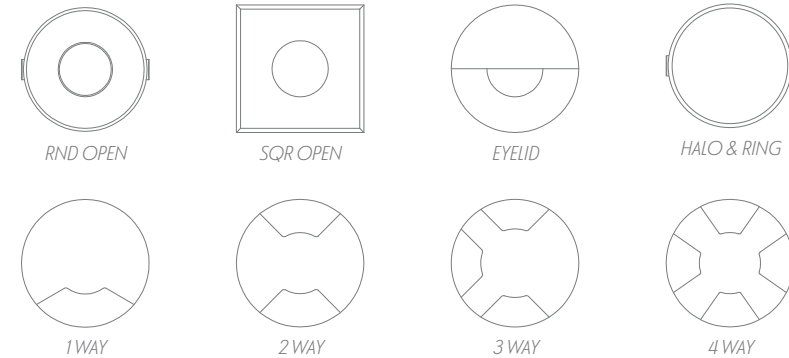

| Item No. | Variant | | | | | | | | | CCT |
|------------------|----------|----------|--------|-------|-------|-------|-------|-------|-------|------|
| | RND Open | SQR Open | Eyelid | 1Way | 2Way | 3Way | 4Way | Halo | Ring | |
| EMIT-25-TRIO-STS | 10010 | 10011 | 10012 | 10013 | 10014 | 10015 | 10016 | 10017 | 10018 | TRIO |

Exterior

Exterior



LED Deck Lights

Black



EMIT-25-RO-BLK EMIT-25-SO-BLK EMIT-25-EYELID-BLK EMIT-25-HALO-BLK EMIT-25-RING-BLK



EMIT-25-1WAY-BLK EMIT-25-2WAY-BLK EMIT-25-3WAY-BLK EMIT-25-4WAY-BLK

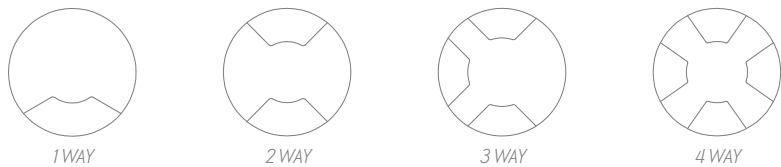
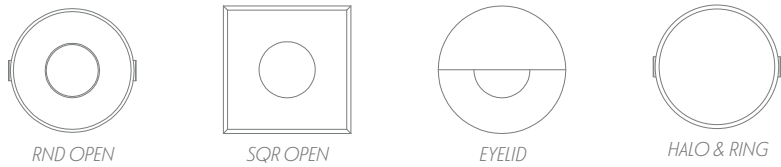

| Item No. | Variant | | | | | | | | | CCT |
|-------------------------|--------------|--------------|--------------|--------------|--------------|--------------|--------------|--------------|--------------|------|
| | RND Open | SQR Open | Eyelid | 1Way | 2Way | 3Way | 4Way | Halo | Ring | |
| EMIT-25-TRIO-BLK | 10000 | 10001 | 10002 | 10003 | 10004 | 10005 | 10006 | 10007 | 10008 | TRIO |



LED Deck Lights

Antique Brass



EMIT-25-RO-AB EMIT-25-SO-AB EMIT-25-EYELID-AB EMIT-25-HALO-AB EMIT-25-RING-AB



EMIT-25-1WAY-AB EMIT-25-2WAY-AB EMIT-25-3WAY-AB EMIT-25-4WAY-AB

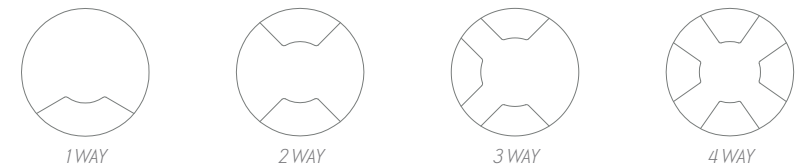
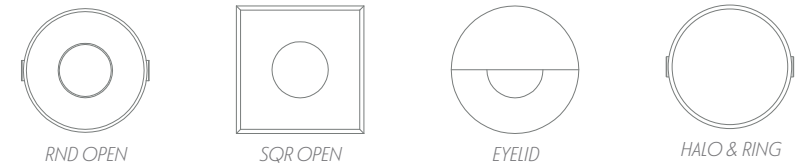

| Item No. | Variant | | | | | | | | | CCT |
|------------------------|--------------|--------------|--------------|--------------|--------------|--------------|--------------|--------------|--------------|------|
| | RND Open | SQR Open | Eyelid | 1Way | 2Way | 3Way | 4Way | Halo | Ring | |
| EMIT-25-TRIO-AB | 10030 | 10031 | 10032 | 10033 | 10034 | 10035 | 10036 | 10037 | 10038 | TRIO |

Exterior

Exterior



Brass



EMIT-25-RO-BRS EMIT-25-SO-BRS EMIT-25-EYELID-BRS EMIT-25-HALO-BRS EMIT-25-RING-BRS



EMIT-25-1WAY-BRS EMIT-25-2WAY-BRS EMIT-25-3WAY-BRS EMIT-25-4WAY-BRS

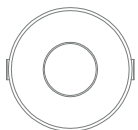

RND OPEN

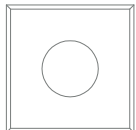

SQR OPEN

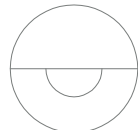

EYELID

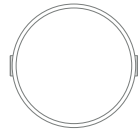

HALO & RING



1 WAY

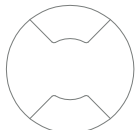

2 WAY



3 WAY

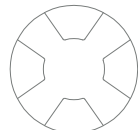

4 WAY

Item No.

Variant

CCT

| | | | | | | | | | | |
|------------------|-------|-------|-------|-------|-------|-------|-------|-------|-------|------|
| EMIT-25-RGBW-BRS | 10020 | 10021 | 10022 | 10023 | 10024 | 10025 | 10026 | 10027 | 10028 | RGBW |
|------------------|-------|-------|-------|-------|-------|-------|-------|-------|-------|------|



Emit 25 RGBW Series



Introducing the EMIT-25 RGBW LED Inground Light Series. The EMIT-25 RGBW is a mini inground light with a cutout of 19mm, ideal for lighting up features where minimalistic light effects are required. Featuring a 1W LED output, with a range of different fascia plates and metalware colour options. Choose from Round Open, Square Open, Eyelid and Halo fascias, as well as the multiway fascias available in 1WAY, 2WAY, 3WAY, and 4WAY. Metalware colour options range from Black, Stainless Steel, Antique Brass and Brushed Brass. RGBW Colour Changeable with the use of an RGBW Colour Controller. Colour selectable from RGB as well as White colours. Functional with 12 and 24V DC Constant Voltage LED Drivers. Optional extra accessories such as narrow to medium Beam Angle Lens as well as Honeycomb and frosted diffusers are also available. Part of a family of different sizes to suit most inground lighting applications. Backed by a 5 Year Replacement Warranty.

Specification Features

- Input Voltage: 12/24V DC
- Power (W): 1W
- IP rating (IP): IP67
- IK Rating (IK): IK10
- LED type: CREE
- CCT: RGBW
- Beam angle (°): 19° - 36° - 60° (60° Standard)
- Dimmable: No
- Lifespan (hrs): 50,000hrs
- Cutout (Ø): Ø19mm Without Cannister
Ø22mm With Cannister

Requires RGBW Colour Controller (Suggested Controller - CHAM-BT-RF-5C 20141)
Requires 12 or 24V Constant Voltage LED Driver (Wire in Parallel)

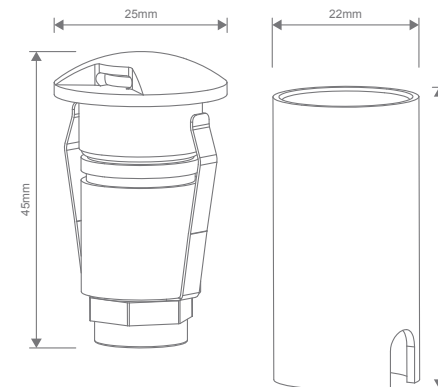

Honeycomb (Optional)



Opal Diffuser (Optional)



Water Stop Cable Joint



19° & 36° Lens (Optional)

Exterior

Exterior



LED Deck Lights

Stainless Steel



EMIT-25-RO-ST5 EMIT-25-SO-ST5 EMIT-25-EYELID-ST5 EMIT-25-HALO-ST5 EMIT-25-RING-ST5



EMIT-25-1WAY-ST5 EMIT-25-2WAY-ST5 EMIT-25-3WAY-ST5 EMIT-25-4WAY-ST5

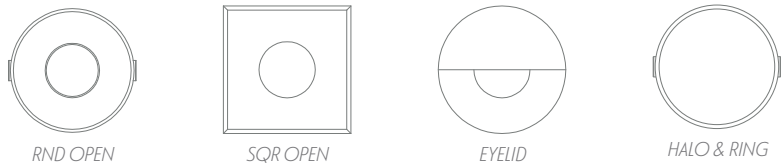

RND OPEN SQR OPEN EYELID HALO & RING

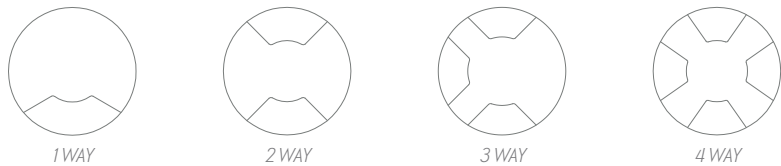

1WAY 2WAY 3WAY 4WAY

| Item No. | Variant | | | | | | | | | CCT |
|-------------------------|--------------|--------------|--------------|--------------|--------------|--------------|--------------|--------------|--------------|------|
| | RND Open | SQR Open | Eyelid | 1Way | 2Way | 3Way | 4Way | Halo | Ring | |
| EMIT-25-RGBW-ST5 | 10010 | 10011 | 10012 | 10013 | 10014 | 10015 | 10016 | 10017 | 10018 | RGBW |



LED Deck Lights

Black



EMIT-25-RO-BLK EMIT-25-SO-BLK EMIT-25-EYELID-BLK EMIT-25-HALO-BLK EMIT-25-RING-BLK



EMIT-25-1WAY-BLK EMIT-25-2WAY-BLK EMIT-25-3WAY-BLK EMIT-25-4WAY-BLK

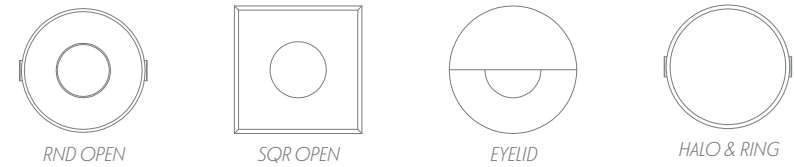

RND OPEN SQR OPEN EYELID HALO & RING

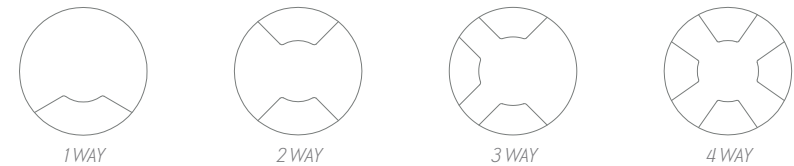

1WAY 2WAY 3WAY 4WAY

| Item No. | Variant | | | | | | | | | CCT |
|-------------------------|--------------|--------------|--------------|--------------|--------------|--------------|--------------|--------------|--------------|------|
| | RND Open | SQR Open | Eyelid | 1Way | 2Way | 3Way | 4Way | Halo | Ring | |
| EMIT-25-RGBW-BLK | 10000 | 10001 | 10002 | 10003 | 10004 | 10005 | 10006 | 10007 | 10008 | RGBW |

Exterior

Exterior



LED Deck Lights

Antique Brass



EMIT-25-RO-AB EMIT-25-SO-AB EMIT-25-EYELID-AB EMIT-25-HALO-AB EMIT-25-RING-AB



EMIT-25-1WAY-AB EMIT-25-2WAY-AB EMIT-25-3WAY-AB EMIT-25-4WAY-AB

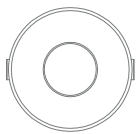

RND OPEN

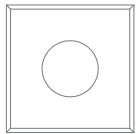

SQR OPEN

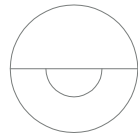

EYELID

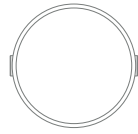

HALO & RING

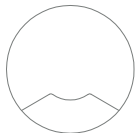

1WAY

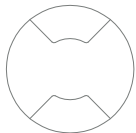

2WAY



3WAY

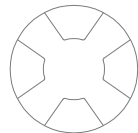

4WAY

| Item No. | Variant | | | | | | | | | CCT |
|------------------------|--------------|--------------|--------------|--------------|--------------|--------------|--------------|--------------|--------------|------|
| | RND Open | SQR Open | Eyelid | 1Way | 2Way | 3Way | 4Way | Halo | Ring | |
| EMIT-25-RGBW-AB | 10070 | 10071 | 10072 | 10073 | 10074 | 10075 | 10076 | 10077 | 10078 | RGBW |



LED Deck Lights

Brass

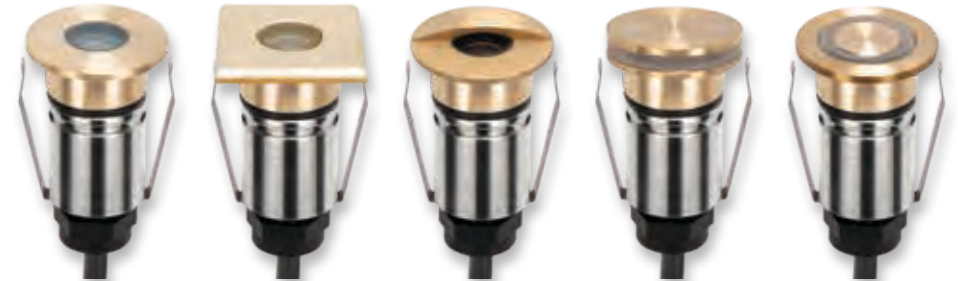

EMIT-25-RO-BRS EMIT-25-SO-BRS EMIT-25-EYELID-BRS EMIT-25-HALO-BRS EMIT-25-RING-BRS



EMIT-25-1WAY-BRS EMIT-25-2WAY-BRS EMIT-25-3WAY-BRS EMIT-25-4WAY-BRS

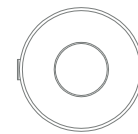

RND OPEN

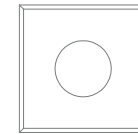

SQR OPEN

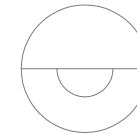

EYELID

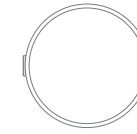

HALO & RING

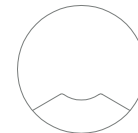

1WAY

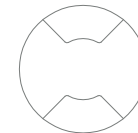

2WAY

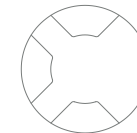

3WAY

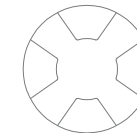

4WAY

| Item No. | Variant | | | | | | | | | CCT |
|-------------------------|--------------|--------------|--------------|--------------|--------------|--------------|--------------|--------------|--------------|------|
| | RND Open | SQR Open | Eyelid | 1Way | 2Way | 3Way | 4Way | Halo | Ring | |
| EMIT-25-RGBW-BRS | 10060 | 10061 | 10062 | 10063 | 10064 | 10065 | 10066 | 10067 | 10068 | RGBW |

Exterior

Exterior



Emit 55 TRIO Series

Introducing the EMIT-55 LED Inground Light Series. The EMIT-55 is a 55mm overall diameter inground light with a cutout of 43mm without cannister, ideal for lighting up features where minimalistic light effects are required. Featuring a 2.5W LED output, with a range of different fascia plates and metalware colour options. Choose from Round Open, Square Open, Eyelid and Halo fascias, as well as the multiway fascias available in 1WAY, 2WAY, 3WAY, and 4WAY. Metalware colour options range from Black, Stainless Steel, Antique Brass and Brushed Brass. Tri-Colour Selectable: Choose from 3000K Warm White, 4000K Neutral White and 5500K White colour temperature options. Functional with 12 and 24V DC Constant Voltage LED Drivers. Optional extra accessories such as narrow to medium Beam Angle Lens as well as Honeycomb, Linear Lens and opal diffuser are also available. Part of a family of different sizes to suit most inground lighting applications. Backed by a 5 Year Replacement Warranty.

Specification Features

| | | | | | | | | | |
|-----------------|---|----------|--------|------|------|------|------|------|------|
| Input Voltage: | 12/24V DC | | | | | | | | |
| Power (W): | 2.5W | | | | | | | | |
| IP rating (IP): | IP67 | | | | | | | | |
| IK Rating (IK): | IK10 | | | | | | | | |
| Lumens | RND OPEN | SQR OPEN | EYELID | 1WAY | 2WAY | 3WAY | 4WAY | HALO | RING |
| 3000K | 135 | 135 | 80 | 2.5 | 5.4 | 4.0 | 4.4 | 22 | 28 |
| 4000K | 145 | 145 | 85 | 2.5 | 5.4 | 4.0 | 4.4 | 22 | 28 |
| 5500K | 150 | 150 | 88 | 2.5 | 5.4 | 4.0 | 4.4 | 22 | 28 |
| LED type: | CREE | | | | | | | | |
| CCT: | 3000K-4000K-5500K (Changeable) | | | | | | | | |
| CRI: | ≥90 | | | | | | | | |
| Beam angle (°): | 19° - 36° - 60° (60° Standard) | | | | | | | | |
| Dimmable: | No | | | | | | | | |
| Lifespan (hrs): | 50,000hrs | | | | | | | | |
| Cutout (Ø): | Ø45mm Without Cannister Ø48mm With Cannister | | | | | | | | |

Requires 12 or 24V Constant Voltage LED Driver (Wire in Parallel)

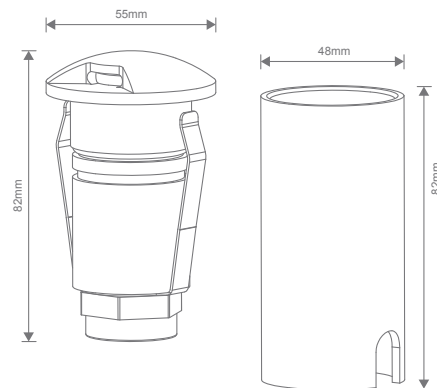

Water Stop Cable Joint



Honeycomb (Optional)



Opal Diffuser (Optional)



Linear Lens (Optional)



19° & 36° Lens (Optional)



Stainless Steel



EMIT-55-RO-STSS



EMIT-55-SO-STSS



EMIT-55-EYELID-STSS



EMIT-55-HALO-STSS



EMIT-55-RING-STSS



EMIT-55-1WAY-STSS



EMIT-55-2WAY-STSS



EMIT-55-3WAY-STSS



EMIT-55-4WAY-STSS

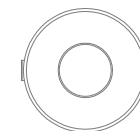

RND OPEN

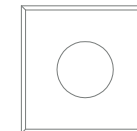

SQR OPEN

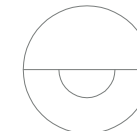

EYELID

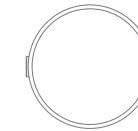

HALO & RING

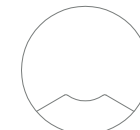

1WAY

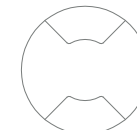

2WAY



3WAY

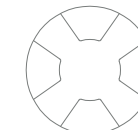

4WAY

Item No.

Variant

CCT

| | | | | | | | | | | |
|-------------------|-------|-------|-------|-------|-------|-------|-------|-------|-------|------|
| EMIT-55-TRIO-STSS | 10097 | 10098 | 10099 | 10100 | 10101 | 10102 | 10103 | 10104 | 10105 | TRIO |
|-------------------|-------|-------|-------|-------|-------|-------|-------|-------|-------|------|



LED Deck Lights

Black



EMIT-55-RO-BLK EMIT-55-SO-BLK EMIT-55-EYELID-BLK EMIT-55-HALO-BLK EMIT-55-HALO-BLK



EMIT-55-1WAY-BLK EMIT-55-2WAY-BLK EMIT-55-3WAY-BLK EMIT-55-4WAY-BLK

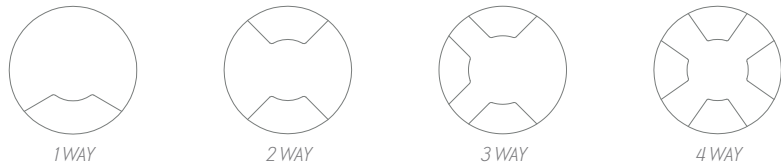
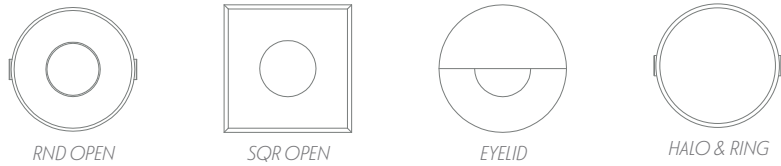

| Item No. | Variant | | | | | | | | | CCT |
|-------------------------|--------------|--------------|--------------|--------------|--------------|--------------|--------------|--------------|--------------|------|
| | RND Open | SQR Open | Eyelid | 1 Way | 2 Way | 3 Way | 4 Way | Halo | Ring | |
| EMIT-55-TRIO-BLK | 10087 | 10088 | 10089 | 10090 | 10091 | 10092 | 10093 | 10094 | 10095 | TRIO |



LED Deck Lights

Antique Brass



EMIT-55-RO-AB EMIT-55-SO-AB EMIT-55-EYELID-AB EMIT-55-HALO-AB EMIT-55-RING-AB



EMIT-55-1WAY-AB EMIT-55-2WAY-AB EMIT-55-3WAY-AB EMIT-55-4WAY-AB

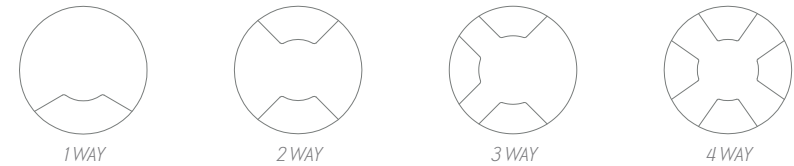
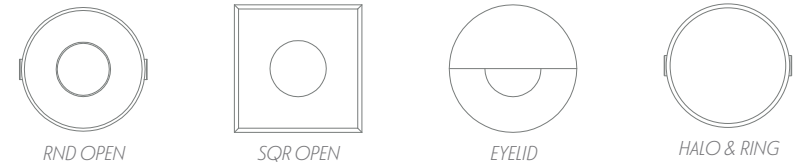

| Item No. | Variant | | | | | | | | | CCT |
|------------------------|--------------|--------------|--------------|--------------|--------------|--------------|--------------|--------------|--------------|------|
| | RND Open | SQR Open | Eyelid | 1 Way | 2 Way | 3 Way | 4 Way | Halo | Ring | |
| EMIT-25-TRIO-AB | 10117 | 10118 | 10119 | 10120 | 10121 | 10122 | 10123 | 10124 | 10125 | TRIO |

Exterior

Exterior



Brass



EMIT-55-RO-BRS



EMIT-55-SO-BRS



EMIT-55-EYELID-BRS



EMIT-55-HALO-BRS



EMIT-55-RING-BRS



EMIT-55-1WAY-BRS



EMIT-55-2WAY-BRS



EMIT-55-3WAY-BRS



EMIT-55-4WAY-BRS

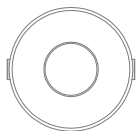

RND OPEN

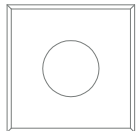

SQR OPEN

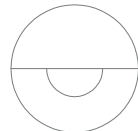

EYELID

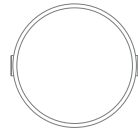

HALO & RING

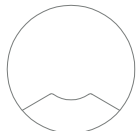

1 WAY

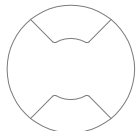

2 WAY



3 WAY

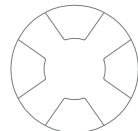

4 WAY

| Item No. | Variant | | | | | | | | | CCT |
|------------------|----------|----------|--------|-------|-------|-------|-------|-------|-------|------|
| | RND Open | SQR Open | Eyelid | 1 Way | 2 Way | 3 Way | 4 Way | Halo | Ring | |
| EMIT-55-TRIO-BRS | 10107 | 10108 | 10109 | 10110 | 10111 | 10112 | 10113 | 10114 | 10115 | TRIO |



Emit 55 RGBW Series



Introducing the EMIT-55-RGBW LED Inground Light Series. The EMIT-55 is a 55mm overall diameter inground light with a cutout of 43mm without cannister, ideal for lighting up features where minimalistic light effects are required. Featuring a 2.5W LED output, with a range of different fascia plates and metalware colour options. Choose from Round Open, Square Open, Eyelid and Halo fascias, as well as the multiway fascias available in 1WAY, 2WAY, 3WAY, and 4WAY. Metalware colour options range from Black, Stainless Steel, Antique Brass and Brushed Brass. RGBW Colour Changeable with the use of an RGBW Colour Controller. Colour selectable from RGB as well as White colours. Functional with 12 and 24V DC Constant Voltage LED Drivers. Optional extra accessories such as narrow to medium Beam Angle Lens as well as Honeycomb and frosted diffusers are also available. Part of a family of different sizes to suit most inground lighting applications. Backed by a 5 Year Replacement Warranty.

Specification Features

- Input Voltage: 12/24V DC
- Power (W): 2.5W
- IP rating (IP): IP67
- IK Rating (IK): IK10
- LED type: CREE
- CCT: RGBW
- Beam angle (°): 19° - 36° - 60° (60° Standard)
- Dimmable: No
- Lifespan (hrs): 50,000hrs
- Cutout (Ø): Ø45mm Without Cannister
Ø48mm With Cannister

Requires RGBW Colour Controller (Suggested Controller - CHAM-BT-RF-5C 20141)
Requires 12 or 24V Constant Voltage LED Driver (Wire in Parallel)

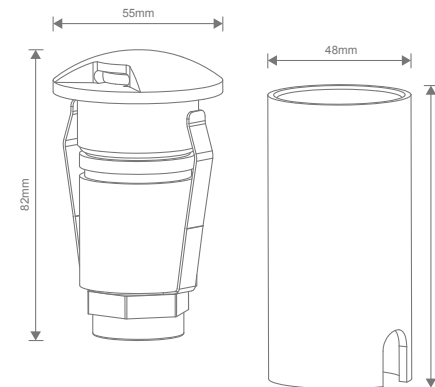

Honeycomb (Optional)



Opal Diffuser (Optional)



Water Stop Cable Joint



19° & 36° Lens (Optional)

Exterior

Exterior



LED Deck Lights

Stainless Steel



EMIT-55-RO-ST5 EMIT-55-SO-ST5 EMIT-55-EYELID-ST5 EMIT-55-HALO-ST5 EMIT-55-RING-ST5



EMIT-55-1WAY-ST5 EMIT-55-2WAY-ST5 EMIT-55-3WAY-ST5 EMIT-55-4WAY-ST5

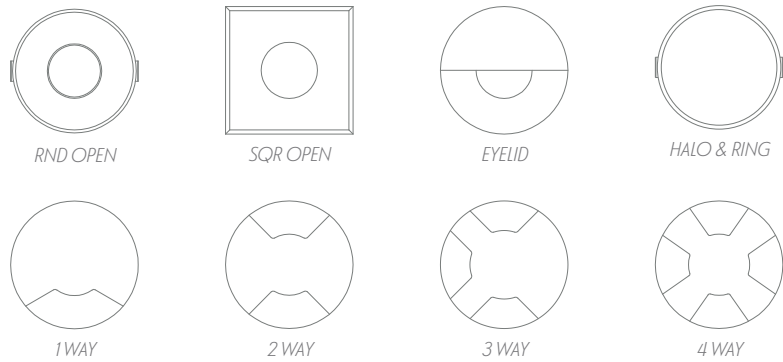

| Item No. | Variant | | | | | | | | | CCT |
|-------------------------|--------------|--------------|--------------|--------------|--------------|--------------|--------------|--------------|--------------|------|
| | RND Open | SQR Open | Eyelid | 1Way | 2Way | 3Way | 4Way | Halo | Ring | |
| EMIT-55-RGBW-ST5 | 10137 | 10138 | 10139 | 10140 | 10141 | 10142 | 10143 | 10144 | 10145 | RGBW |



LED Deck Lights

Black



EMIT-55-RO-BLK EMIT-55-SO-BLK EMIT-55-EYELID-BLK EMIT-55-HALO-BLK EMIT-55-RING-BLK



EMIT-55-1WAY-BLK EMIT-55-2WAY-BLK EMIT-55-3WAY-BLK EMIT-55-4WAY-BLK

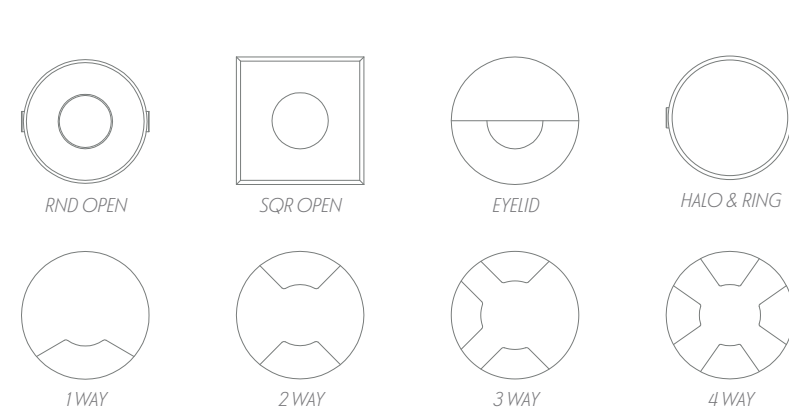

| Item No. | Variant | | | | | | | | | CCT |
|-------------------------|--------------|--------------|--------------|--------------|--------------|--------------|--------------|--------------|--------------|------|
| | RND Open | SQR Open | Eyelid | 1Way | 2Way | 3Way | 4Way | Halo | Ring | |
| EMIT-55-RGBW-BLK | 10127 | 10128 | 10129 | 10130 | 10131 | 10132 | 10133 | 10134 | 10135 | RGBW |

Exterior

Exterior



LED Deck Lights

Antique Brass



EMIT-55-AB-RO EMIT-55-AB-SO EMIT-55-AB-EYELID EMIT-55-AB-HALO EMIT-55-AB-RING



EMIT-55-AB-1WAY EMIT-55-AB-2WAY EMIT-55-AB-3WAY EMIT-55-AB-4WAY

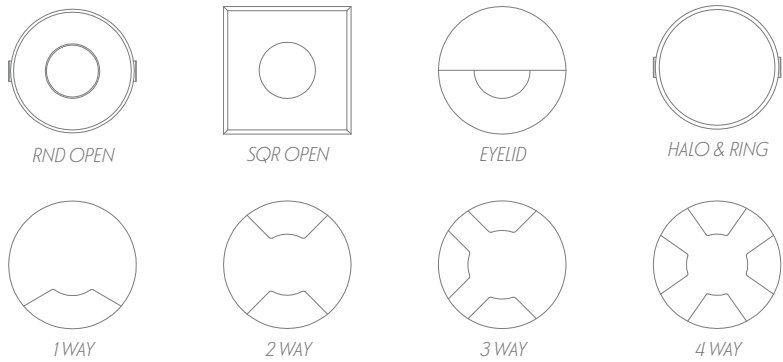

| Item No. | Variant | | | | | | | | | CCT |
|------------------------|--------------|--------------|--------------|--------------|--------------|--------------|--------------|--------------|--------------|------|
| | RND Open | SQR Open | Eyelid | 1Way | 2Way | 3Way | 4Way | Halo | Ring | |
| EMIT-55-RGBW-AB | 10157 | 10158 | 10159 | 10160 | 10161 | 10162 | 10163 | 10164 | 10165 | RGBW |



LED Deck Lights

Brass



EMIT-55-BRS-RO EMIT-55-BRS-SO EMIT-55-BRS-EYELID EMIT-55-BRS-HALO EMIT-55-BRS-RING



EMIT-55-BRS-1WAY EMIT-55-BRS-2WAY EMIT-55-BRS-3WAY EMIT-55-BRS-4WAY

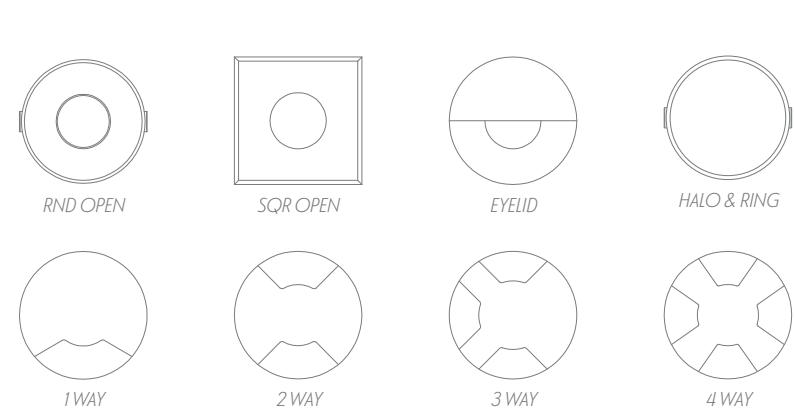

| Item No. | Variant | | | | | | | | | CCT |
|-------------------------|--------------|--------------|--------------|--------------|--------------|--------------|--------------|--------------|--------------|------|
| | RND Open | SQR Open | Eyelid | 1Way | 2Way | 3Way | 4Way | Halo | Ring | |
| EMIT-55-RGBW-BRS | 10147 | 10148 | 10149 | 10150 | 10151 | 10152 | 10153 | 10154 | 10155 | RGBW |

Exterior

Exterior



Deka Series



- COB LED chip.
- Anodised Aluminium or Solid Brass fascia.
- Black anodised Aluminium body.
- 60 Degrees beam angle (on open face).
- Installation cannister included.

Open/Eyelid

1-4 Ways



DEKA-EYELID (Aluminium)



DEKA-EYELID (Brass)



DEKA-1WAY (Aluminium)



DEKA-1WAY (Brass)



DEKA-RND (Aluminium)



DEKA-RND (Brass)



DEKA-2WAY (Aluminium)



DEKA-2WAY (Brass)



DEKA-SQR (Aluminium)



DEKA-SQR (Brass)



DEKA-3WAY (Aluminium)



DEKA-3WAY (Brass)



DEKA-4WAY (Aluminium)



DEKA-4WAY (Brass)



Covers: SQR, RND
1,2,3,4 Way & Eyelid

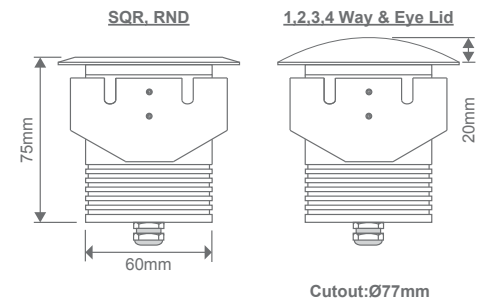
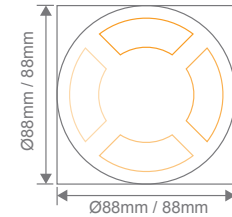

| Item No. | Variant | Wattage | IP Rating | CCT | Lumen Output | Requires |
|-----------|---------|---------|-----------|-------|--------------|---|
| DEKA BODY | 19458 | 3W | 65 | 3000K | 300lm | 12V DC Constant Voltage LED Driver – Wire in Parallel |
| | 19459 | | | 5000K | 350lm | |

| ITEM NO. | | Variant | |
|-------------|--------------|---------|-------|
| | | Alu | BrS |
| DEKA FASCIA | Round Cover | 19424 | 19438 |
| | Square Cover | 19426 | 19440 |
| | Eyelid Cover | 19436 | 19450 |
| | 1-Way | 19428 | 19442 |
| | 2-Way | 19430 | 19444 |
| | 3-Way | 19432 | 19446 |
| | 4-Way | 19434 | 19448 |

Please order this product in two parts using two codes, one for the body and another for the fascia.



Exterior

Exterior

Electromagnetic Induction

No direct cable connection from base unit to LED Light.

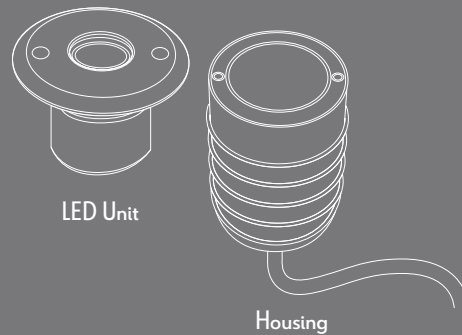

Induction technology passes current to LED Light through magnetic process to illuminate LED.

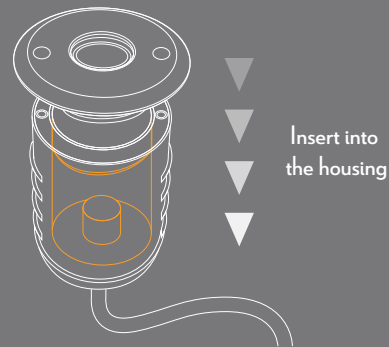

No more failed Inground lights from filling up with water, simply provide a 24V DC waterproof connection to the unit.

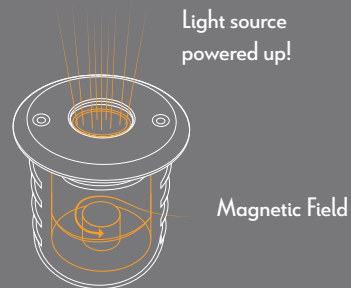

LED Inground Lights

Magneto Series

Introducing a revolutionary new design in inground lighting. The MAGNETO series from Domus features induction technology to transfer electrical current from the base pot to the light unit WITHOUT any cable connection. This avoids water syphoning through the cables and causing the LED light to prematurely fail due to moisture. Also provides for a very easy maintenance by simply unscrewing the light unit and replacing it without the need for an electrician. Ideal as a path light or inground light close to walls or columns to achieve wall washing or v-line effects. 3W 24V DC LED Inground light, 316 Stainless Steel Light Unit, optic lens diffuser. Available as a spot or flood.

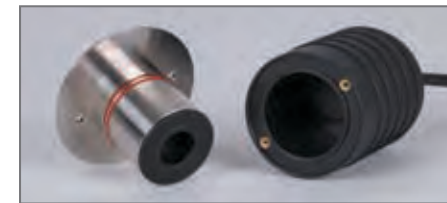

Magneto-3 (60° or 25°)

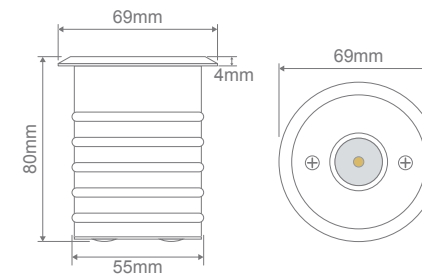

Cutout: Ø60-65mm



| Item No. | Variant | Wattage | IP Rating | CCT | Beam Angle | Lumen Output | Requires |
|------------------|---------|---------|-----------|-------|------------|--------------|--|
| MAGNETO 3 60D | 21082 | 3W | 67 | 3000K | 60° | 95lm | 24V DC Constant Voltage LED Driver - Wire in Parallel |
| | 21083 | | | 5000K | | | |
| MAGNETO 3 25D | 21080 | 3W | 67 | 3000K | 25° | 95lm | 24V DC Constant Voltage LED Driver - Wire in Parallel |
| | 21081 | | | 5000K | | | |

Drive over rating: 2000kg



LED Inground Lights

Magneto Series



Magneto-9-45°

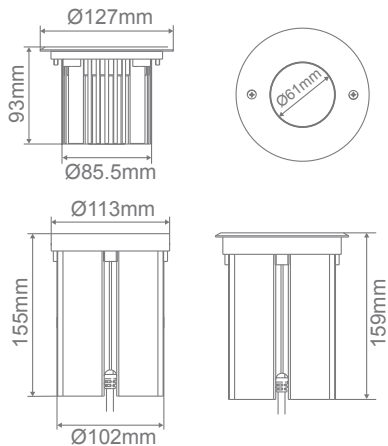

Cutout: Ø110-120mm



LED Inground Lights

Magneto Series



Magneto-18-45°

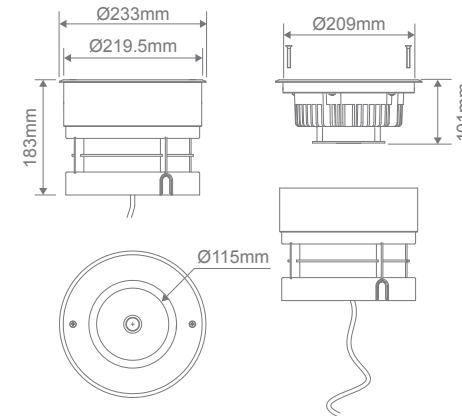

Cutout: Ø205-215mm



Exterior

Exterior

| Item No. | Variant | Wattage | IP Rating | CCT | Lumen Output | Requires |
|---------------|---------|---------|-----------|-------|--------------|---|
| MAGNETO-9-45D | 21086 | 9W | 67 | 3000K | 675lm | 24V DC Constant Voltage LED Driver - Wire in Parallel |
| | 21088 | | | 5000K | 720lm | |

| Item No. | Variant | Wattage | IP Rating | CCT | Lumen Output | Requires |
|----------------|---------|---------|-----------|-------|--------------|---|
| MAGNETO-18-45D | 21095 | 18W | 67 | 3000K | 1350lm | 24V DC Constant Voltage LED Driver - Wire in Parallel |
| | 21098 | | | 5000K | 1450lm | |



LED Inground Lights

Modula Series

- COB LED chip.
- Anodised Aluminium.
- Black anodised Aluminium body.
- 45 Degrees beam angle.
- Installation cannister included.
- Drive over rating of 2000kgs



MODULA-9-RND



MODULA-9-SQR

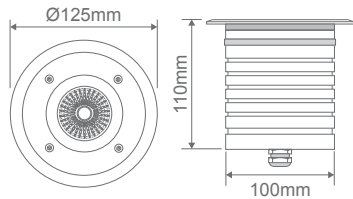

Cutout: Ø110mm

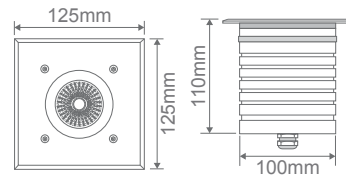

Cutout: Ø110mm

| Item No. | Variant | Wattage | IP Rating | CCT | Lumen Output | Requires |
|--------------|---------|---------|-----------|-------|--------------|---|
| MODULA-9-RND | 19420 | 9W | 65 | 3000K | 900lm | 24V DC Constant Voltage LED Driver - Wire in Parallel |
| | 19421 | | | 5000K | 950lm | |
| MODULA-9-SQR | 19422 | 9W | 65 | 3000K | 900lm | 24V DC Constant Voltage LED Driver - Wire in Parallel |
| | 19423 | | | 5000K | 950lm | |



LED Bunker Lights



Versa Series

- Polycarbonate Body and Diffuser.
- IK08 Impact rated.
- Triple wattage option.
- Inbuilt LED driver included.
- Side Conduit entry.



VERSA-300-PLN



VERSA-300-ELID

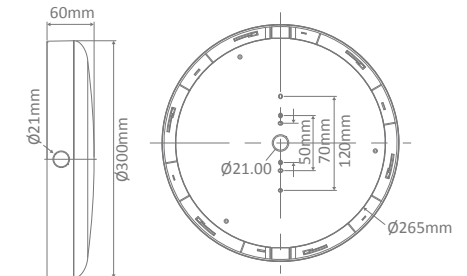

| Item No. | Variant | | Wattage (Switchable) | CCT | Watt | Lumen Output | | |
|---------------|---------|-------|----------------------|------|------|------------------|---------------------|-------------|
| | Blk | Wht | | | | Warm White 3000K | Neutral White 4000K | White 5700K |
| VERSA-300-PLN | 19800 | 19802 | 15W/18W/25W | TRIO | 15W | 1380lm | 1420lm | 1470lm |
| | | | | | | 1560lm | 1650lm | 1710lm |
| | | | | | | 2080lm | 2200lm | 2320lm |
| VERSA-300-EYE | 19804 | 19806 | 15W/18W/25W | TRIO | 15W | 830lm | 850lm | 880lm |
| | | | | | | 940lm | 990lm | 1050lm |
| | | | | | | 1250lm | 1320lm | 1400lm |

Exterior

Exterior



Polysphere Series

- Injection Moulded Thermoplastic Base.
- Acrylic Sphere.
- Designed to suit 60mm OD posts.



Exterior



Exterior

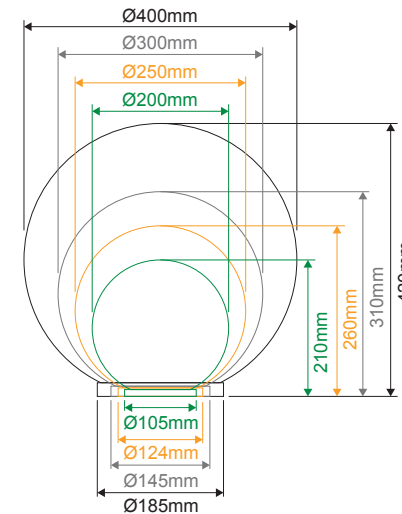

| Sphere Hole Size: | |
|-------------------|------------|
| Inner Hole | Outer Hole |
| 92mm | 99mm |
| 110mm | 118mm |
| 120mm | 139mm |
| 165mm | 178mm |

| Item No. | Variant | | IP Rating | Wattage | Requires |
|----------------------|--------------|--------------|-----------|-------------------------|----------------------------|
| | Blk/Opl | Blk/Smk | | | |
| POLYSHERE 200 | 18599 | 18600 | 44 | 25W LED M _{ax} | 1xE27 Globe (Not Included) |
| POLYSHERE 250 | 18601 | 18602 | 44 | 25W LED M _{ax} | 1xE27 Globe (Not Included) |
| POLYSHERE 300 | 18603 | 18604 | 44 | 25W LED M _{ax} | 1xE27 Globe (Not Included) |
| POLYSHERE 400 | 18605 | 18606 | 44 | 25W LED M _{ax} | 1xE27 Globe (Not Included) |



60mm Aluminium Post Series



Black

Green

Silver

Beige

White

| Item No. | Variant | | | | | Size |
|----------|---------|-------|-------|-------|-------|-----------|
| | Blk | Grn | Slr | Bge | Wht | |
| AP-6010 | 10820 | 10822 | 10821 | 10819 | 10824 | 60x1000mm |
| AP-6015 | 10826 | 10828 | 10827 | 10825 | 10830 | 60x1500mm |
| AP-6020 | 10832 | 10834 | 10833 | 10831 | 10836 | 60x2000mm |
| AP-6025 | 10838 | 10840 | 10839 | 10837 | 10842 | 60x2500mm |



76mm Aluminium Post Series



- BB-100 base can hold 60mm post internally or 76mm post externally.
- Please note that 76mm post must be mechanically fixed to base manually, as there is no provision on the post nor the base supplied. Contractor to supply screw fixings and screws and assemble.



Black

Green

White

Beige

Silver

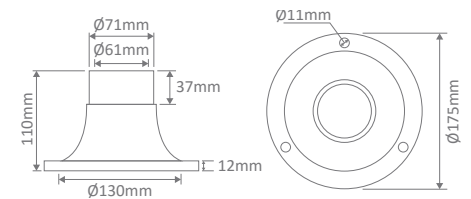

BB-100

| Item No. | Variant | | | | | Size |
|----------|---------|-------|-------|-------|-------|------------------------|
| | Blk | Grn | Wht | Bge | Slr | |
| AP-7610 | 10850 | 10852 | 10853 | 10849 | 10851 | 76x1000mm |
| AP-7615 | 10855 | 10857 | 10858 | 10854 | 10856 | 76x1500mm |
| AP-7620 | 10860 | 10862 | 10863 | 10859 | 10861 | 76x2000mm |
| BB-100 | 10696 | 10698 | 10699 | 10695 | 10697 | Suits 60mm & 76mm post |

Exterior

Exterior



BL-100



- Cast Aluminium, powder coated.
- Designed to suit 76mm OD posts.

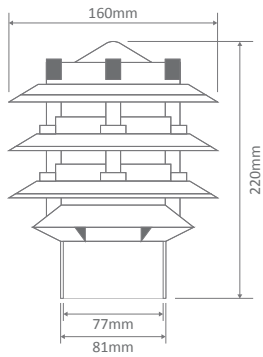

BL-A1-60 - Designed to adapt bollard head 76mm opening to fix 60mm diameter posts.

| Item No. | Variants | | | | | | IP Rating | Wattage | Requires |
|----------|----------|-------|-------|-------|-------|-------------|-----------|-------------|----------------------------|
| | Blk | Grn | Wht | Bge | Slr | Spare Glass | | | |
| BL-100 | 10701 | 10703 | 10704 | 10700 | 10702 | 10773 | 44 | 25W LED Max | 1xE27 Globe (Not Included) |
| BL-A1-60 | 10724 | N/A | N/A | N/A | N/A | N/A | N/A | N/A | N/A |



BL-100-1M-KIT



- Cast Aluminium, powder coated.
- 1 Metre long, 76mm wide OD post.



| Item No. | Variants | | | | | IP Rating | Wattage | Requires |
|---------------|----------|-------|-------|-------|-------|-----------|-------------|----------------------------|
| | Blk | Grn | Wht | Bge | Slr | | | |
| BL-100-1M-KIT | 10729 | 10731 | 10732 | 10728 | 10730 | 44 | 25W LED Max | 1xE27 Globe (Not Included) |

Exterior

Exterior



BL-200



- Cast Aluminium, powder coated.
- Designed to suit 76mm OD posts.

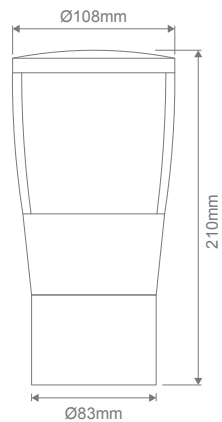

BL-A2-60 - Designed to adapt bollard head 76mm opening to fix 60mm diameter posts.

| Item No. | Variants | | | | | IP Rating | Wattage | Lamp Base |
|----------|----------|-------|-------|-------|-------|-----------|-------------|-------------------------|
| | Blk | Grn | Wht | Bge | Slr | | | |
| BL -200 | 10707 | 10709 | 10710 | 10706 | 10708 | 44 | 25W LED Max | E27 (Lamp Not included) |
| BL-A2-60 | 10725 | N/A | N/A | N/A | N/A | N/A | N/A | N/A |



BL-200-1M-KIT



- Cast Aluminium, powder coated.
- 1 Metre long, 76mm wide OD post.



| Item No. | Variants | | | | | IP Rating | Wattage | Lamp Base |
|----------------|----------|-------|-------|-------|-------|-----------|-------------|-------------------------|
| | Blk | Grn | Wht | Bge | Slr | | | |
| BL -200-1M-KIT | 10735 | 10737 | 10738 | 10734 | 10736 | 44 | 25W LED Max | E27 (Lamp Not included) |

Exterior

Exterior



BL-300



- Cast Aluminium, powder coated.
- Designed to suit 76mm OD posts.

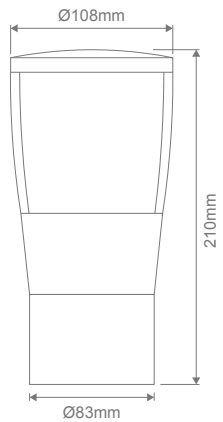

BL-A2-60 - Designed to adapt bollard head 76mm opening to fix 60mm diameter posts.

| Item No. | Variants | | | | | IP Rating | Wattage | Lamp Base |
|----------|----------|-------|-------|-------|-------|-----------|-------------|-------------------------|
| | Blk | Grn | Wht | Bge | Slr | | | |
| BL-300 | 10719 | 10721 | 10722 | 10718 | 10720 | 44 | 25W LED Max | E27 (Lamp Not included) |
| BL-A2-60 | 10725 | N/A | N/A | N/A | N/A | N/A | N/A | N/A |



BL-300-1M-KIT



- Cast Aluminium, powder coated.
- 1 Metre long, 76mm wide OD post.



| Item No. | Variants | | | | | IP Rating | Wattage | Lamp Base |
|---------------|----------|-------|-------|-------|-------|-----------|-------------|-------------------------|
| | Blk | Grn | Wht | Bge | Slr | | | |
| BL-300-1M-KIT | 10741 | 10743 | 10744 | 10740 | 10742 | 44 | 25W LED Max | E27 (Lamp Not included) |

Exterior

Exterior



BL-400



- Cast Aluminium, powder coated.
- Designed to suit 76mm OD posts.
- Clear and Opal Polycarbonate diffuser options.

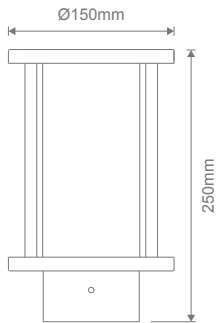

BL-A2-60 - Designed to adapt bollard head 76mm opening to fix 60mm diameter posts.

| Item No. | Variants | | IP Rating | Wattage | Lamp Base |
|----------|----------|-------|-----------|-------------|-------------------------|
| | Clr | Frs | | | |
| BL-400 | 10670 | 10671 | 54 | 25W LED Max | E27 (Lamp Not included) |
| BL-A2-60 | 10725 | N/A | N/A | N/A | N/A |



BL-400-1M-KIT



- Cast Aluminium, powder coated.
- 1 Metre long, 76mm wide OD post.



| Item No. | Variants | | IP Rating | Wattage | Lamp Base |
|---------------|----------|-------|-----------|-------------|-------------------------|
| | Clr | Frs | | | |
| BL-400-1M-KIT | 10682 | 10683 | 54 | 25W LED Max | E27 (Lamp Not included) |

Exterior

Exterior



Area Post Light



Sunsolar-1

- Constructed from ABS polymer and a polycarbonate opal diffuser.
- V0 fireproof, anti-UV
- Designed to suit 60mm posts.
- 3000K/4000K Colour Temperature switchable.

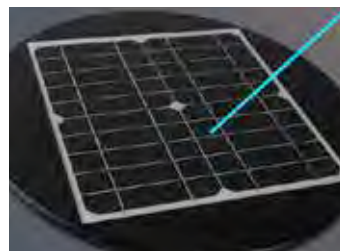
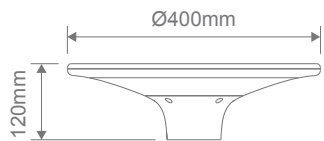

Solar Panel

| Item No. | Variant | IP Rating | CCT |
|------------|---------|-----------|-----|
| SUNSOLAR-1 | 10300 | 65 | DUO |



Area Post Light



Sunsolar-1-Kit

- Constructed from ABS polymer and a polycarbonate opal diffuser.
- V0 fireproof, anti-UV
- Designed to suit 60mm posts.
- 3000K/4000K Colour Temperature switchable.

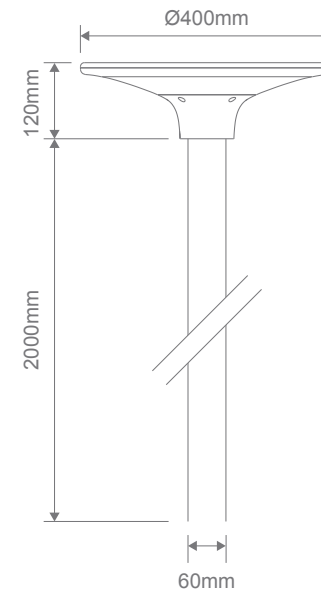

| Item No. | Variant | IP Rating | CCT |
|----------------|---------|-----------|-----|
| SUNSOLAR-1-KIT | 10304 | 65 | DUO |

Exterior

Exterior



Monaco Series



- Cast Aluminium, powder coated.
- Clear Polycarbonate Diffuser.
- Made-To-Order. Production lead times apply.

GT-652 Wall Bracket
Curved Arm

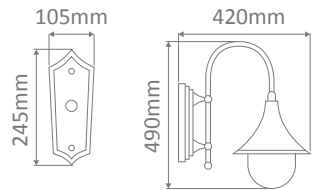

GT-654 Wall Bracket
Straight Arm

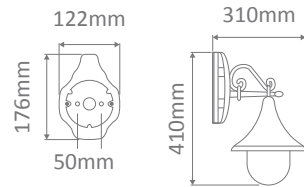

GT-653 Post Bracket
to suit 60mm post mounting only

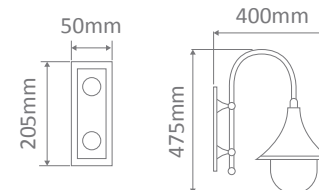

GT-650 Pendant

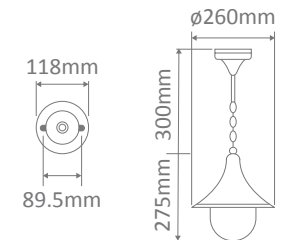

| Item No & Variant | | Colour | | Globe |
|-------------------|--------|--------|----------|-------|
| GT-652 | GT-654 | | | E27 |
| 15806 | 15812 | | Beige | |
| 15807 | 15813 | | Black | |
| 15808 | 15814 | | Burgundy | |
| 15809 | 15815 | | Green | |
| 15811 | 15817 | | White | |

| Item No & Variant | | Colour | | Globe |
|-------------------|--------|--------|----------|-------|
| GT-650 | GT-653 | | | E27 |
| 15800 | 16016 | | Beige | |
| 15801 | 16017 | | Black | |
| 15802 | 16018 | | Burgundy | |
| 15803 | 16019 | | Green | |
| 15805 | 16020 | | White | |



GT-657 Twin Head on Post 1.35m

GT-656 Single Head on Post 1.35m



Width per model:
Single Head - 430mm
Double Head - 840mm

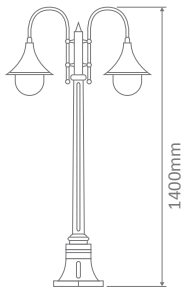

| Item No & Variant | | Colour | | Globe |
|-------------------|--------|----------|--|-------|
| GT-656 | GT-657 | | | |
| 15818 | 15824 | Beige | | E27* |
| 15819 | 15825 | Black | | |
| 15820 | 15826 | Burgundy | | |
| 15821 | 15827 | Green | | |
| 15823 | 15829 | White | | |

*The amount of globes needed will depend on the quantity of heads.



GT-659 Twin Head on Post 1.98m

GT-658 Single Head on Post 1.98m



Width per model:
Single Head - 430mm
Double Head - 840mm

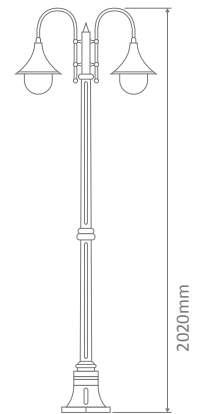

| Item No & Variant | | Colour | | Globe |
|-------------------|--------|----------|--|-------|
| GT-658 | GT-659 | | | |
| 15830 | 15836 | Beige | | E27* |
| 15831 | 15837 | Black | | |
| 15832 | 15838 | Burgundy | | |
| 15833 | 15839 | Green | | |
| 15835 | 15841 | White | | |

*The amount of globes needed will depend on the quantity of heads.

Traditional Exterior

Traditional Exterior



GT-664 Triple Head on Post 2.35m

GT-660 Single Head on Post 2.35m



GT-662 Twin Head on Post 2.35m



Width per model:
Single Head - 430mm
Double Head - 840mm
Triple Head - 820mm

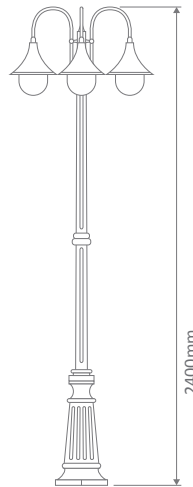

| Item No & Variant | | | Colour | Globe |
|-------------------|--------|--------|----------|-------|
| GT-660 | GT-662 | GT-664 | | |
| 15842 | 15848 | 15854 | Beige | E27* |
| 15843 | 15849 | 15855 | Black | |
| 15844 | 15850 | 15856 | Burgundy | |
| 15845 | 15851 | 15857 | Green | |
| 15847 | 15853 | 15859 | White | |

*The amount of globes needed will depend on the quantity of heads.



GT-1064 Triple Head on Plain Post 2.40m

GT-1068 Single Head on Plain Post 2.40m



GT-1066 Twin Head on Plain Post 2.40m



Width per model:
Single Head - 540mm
Double Head - 840mm
Triple Head - 820mm



| Item No & Variant | | | Colour | Globe |
|-------------------|---------|---------|----------|-------|
| GT-1064 | GT-1066 | GT-1068 | | |
| 15860 | 15866 | 15872 | Beige | E27* |
| 15861 | 15867 | 15873 | Black | |
| 15862 | 15868 | 15874 | Burgundy | |
| 15863 | 15869 | 15875 | Green | |
| 15865 | 15871 | 15877 | White | |

*The amount of globes needed will depend on the quantity of heads.

Traditional Exterior

Traditional Exterior



Lisbon

Lisbon Series

- Cast Aluminium, powder coated.
- Polycarbonate Sphere.
- Made-To-Order. Production lead times apply.



GT-600 Wall Bracket (250mm Sphere)

GT-602 Wall Bracket (300mm Sphere)

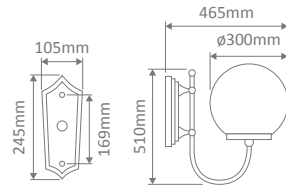
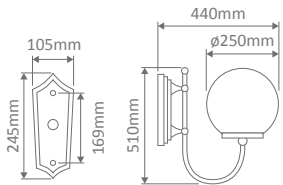

| Item No & Variant | | Colour | Globe |
|-------------------|--------|----------|-------|
| GT-600 | GT-602 | | |
| 15662 | 15668 | Beige | 1xE27 |
| 15663 | 15669 | Black | |
| 15664 | 15670 | Burgundy | |
| 15665 | 15671 | Green | |
| 15667 | 15673 | White | |



Lisbon

GT-608 (250mm Sphere)
 GT-609 (300mm Sphere)
 Double Head on Post 1.32m

GT-606 (250mm Sphere)
 GT-607 (300mm Sphere)
 Single Head on Post 1.32m



Width per model:
 Single Head - 430mm
 Double Head - 820mm

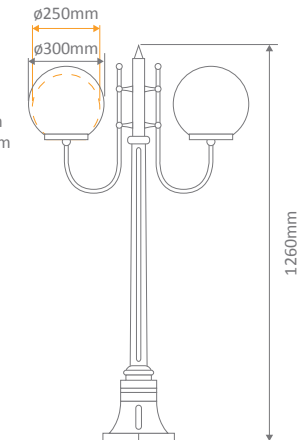

| Item No & Variant | | | | Colour | Globe |
|-------------------|--------|--------|--------|----------|-------|
| GT-606 | GT-607 | GT-608 | GT-609 | | |
| 15674 | 15680 | 15686 | 15692 | Beige | E27* |
| 15675 | 15681 | 15687 | 15693 | Black | |
| 15676 | 15682 | 15688 | 15694 | Burgundy | |
| 15677 | 15683 | 15689 | 15695 | Green | |
| 15679 | 15685 | 15691 | 15697 | White | |

*The amount of globes needed will depend on the quantity of heads.

Traditional Exterior

Traditional Exterior



Lisbon

GT-614 (250mm Sphere)
GT-615 (300mm Sphere)
Double Head on Post 1.94m

GT-612 (250mm Sphere)
GT-613 (300mm Sphere)
Single Head on Post 1.94m

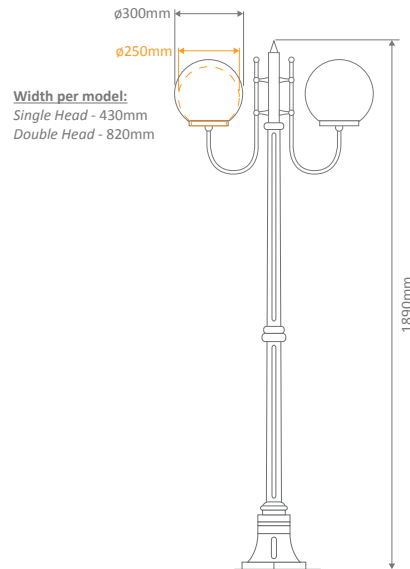

| Item No & Variant | | | | Colour | Globe |
|-------------------|--------|--------|--------|----------|-------|
| GT-612 | GT-613 | GT-614 | GT-615 | | |
| 15698 | 15704 | 15710 | 15716 | Beige | E27* |
| 15699 | 15705 | 15711 | 15717 | Black | |
| 15700 | 15706 | 15712 | 15718 | Burgundy | |
| 15701 | 15707 | 15713 | 15719 | Green | |
| 15703 | 15709 | 15715 | 15721 | White | |

*The amount of globes needed will depend on the quantity of heads.



Lisbon

GT-620 (250mm Sphere)
GT-621 (300mm Sphere)
Double Head on Post 2.29m

GT-618 (250mm Sphere)
GT-619 (300mm Sphere)
Single Head on Post 2.29m

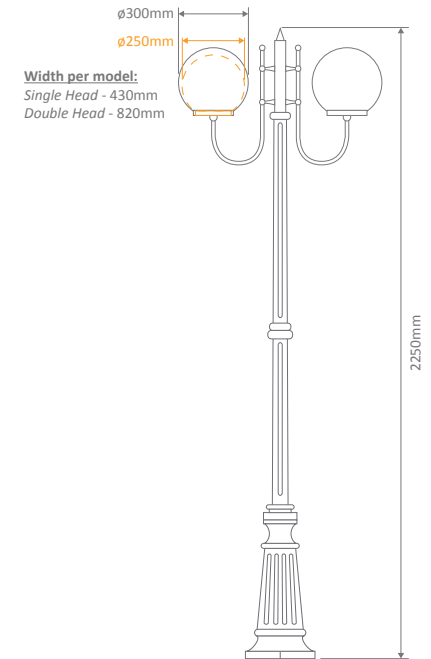

| Item No & Variant | | | | Colour | Globe |
|-------------------|--------|--------|--------|----------|-------|
| GT-618 | GT-619 | GT-620 | GT-621 | | |
| 15722 | 15728 | 15734 | 15740 | Beige | E27* |
| 15723 | 15729 | 15735 | 15741 | Black | |
| 15724 | 15730 | 15736 | 15742 | Burgundy | |
| 15725 | 15731 | 15737 | 15743 | Green | |
| 15727 | 15733 | 15739 | 15745 | White | |

*The amount of globes needed will depend on the quantity of heads.



Lisbon

GT-626 (250mm Sphere)
GT-627 (300mm Sphere)
Quadruple Head on Post 2.54m

GT-622 (250mm Sphere)
GT-623 (300mm Sphere)
Triple Head on Post 2.54m



Width per model:
Triple Head - 890mm
Quadruple Head - 780mm

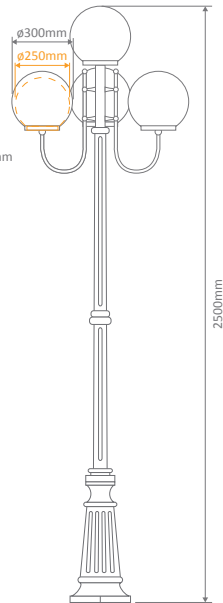

| Item No & Variant | | | | Colour | Globe |
|-------------------|--------|--------|--------|----------|-------|
| GT-622 | GT-623 | GT-626 | GT-627 | | |
| 15746 | 15752 | 15770 | 15776 | Beige | E27* |
| 15747 | 15753 | 15771 | 15777 | Black | |
| 15748 | 15754 | 15772 | 15778 | Burgundy | |
| 15749 | 15755 | 15773 | 15779 | Green | |
| 15751 | 15757 | 15775 | 15781 | White | |

*The amount of globes needed will depend on the quantity of heads.



Lisbon

GT-624 (250mm Sphere)
GT-625 (300mm Sphere)
Triple Head on Post 2.29m

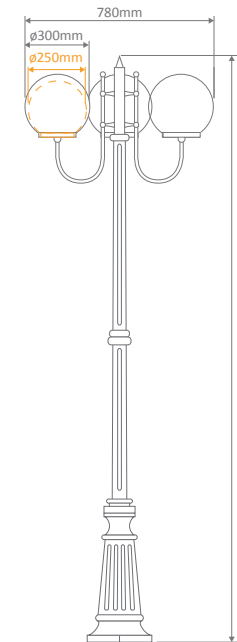

| Variant | | Colour | Globe |
|---------|--------|----------|-------|
| GT-624 | GT-625 | | |
| 15758 | 15764 | Beige | 3xE27 |
| 15759 | 15765 | Black | |
| 15760 | 15766 | Burgundy | |
| 15761 | 15767 | Green | |
| 15763 | 15769 | White | |

Traditional Exterior

Traditional Exterior



GT-1003 Triple Head on Plain Post 2.4m



GT-1001 Single Head on Plain Post 2.4m



GT-1002 Twin Head on Plain Post 2.4m



Width per model:
Single Head - 420mm
Double Head - 820mm
Triple Head - 780mm

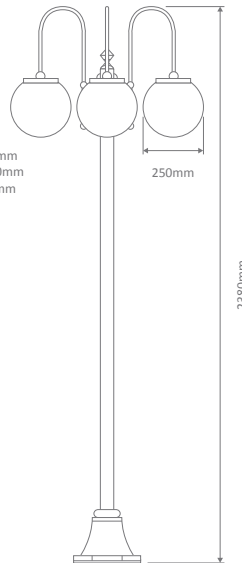

| Item No & Variant | | | Colour | Globe |
|-------------------|---------|---------|----------|-------|
| GT-1001 | GT-1002 | GT-1003 | | |
| 15782 | 15788 | 15794 | Beige | E27* |
| 15783 | 15789 | 15795 | Black | |
| 15784 | 15790 | 15796 | Burgundy | |
| 15785 | 15791 | 15797 | Green | |
| 15787 | 15793 | 15799 | White | |

*The amount of globes needed will depend on the quantity of heads.



Siena Series



- Cast Aluminium, powder coated.
- Polycarbonate Sphere.
- Made-To-Order. Production lead times apply.

GT-544 (200mm Sphere)

GT-545 (250mm Sphere)

Wall Bracket

GT-502 (200mm Sphere)

Wall Bracket

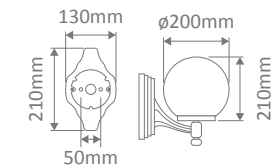
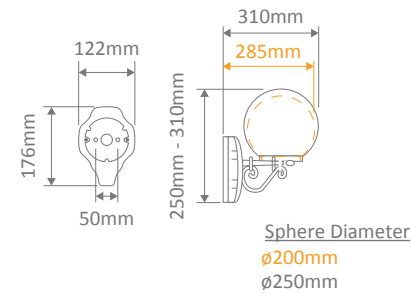

| Item No & Variant | | Colour | Globe |
|-------------------|--------|----------|-------|
| GT-544 | GT-545 | | |
| 15566 | 15572 | Beige | 1xE27 |
| 15567 | 15573 | Black | |
| 15568 | 15574 | Burgundy | |
| 15569 | 15575 | Green | |
| 15571 | 15577 | White | |

| Item No & Variant | Colour | Globe |
|-------------------|----------|-------|
| GT-502 | | |
| 15518 | Beige | 1xE27 |
| 15519 | Black | |
| 15520 | Burgundy | |
| 15521 | Green | |
| 15523 | White | |

Traditional Exterior

Traditional Exterior



GT-503 (250mm Sphere)
GT-504 (300mm Sphere)
180mm Pillar Mount

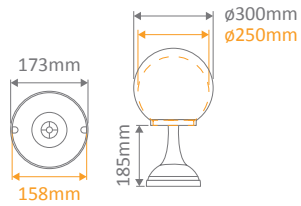

| Item No & Variant | | Colour | Globe |
|-------------------|--------|----------|-------|
| GT-503 | GT-504 | | |
| 15524 | 15530 | Beige | 1xE27 |
| 15525 | 15531 | Black | |
| 15526 | 15532 | Burgundy | |
| 15527 | 15533 | Green | |
| 15529 | 15535 | White | |

GT-530 (200mm Sphere)
GT-531 (250mm Sphere)
80mm Pillar Mount

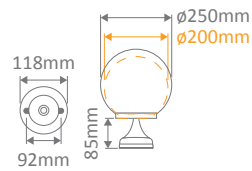

| Item No & Variant | | Colour | Globe |
|-------------------|--------|----------|-------|
| GT-530 | GT-531 | | |
| 15536 | 15542 | Beige | 1xE27 |
| 15537 | 15543 | Black | |
| 15538 | 15544 | Burgundy | |
| 15539 | 15545 | Green | |
| 15541 | 15547 | White | |

GT-535 (200mm Sphere)
GT-536 (250mm Sphere)
GT-537 (300mm Sphere)
Pendant

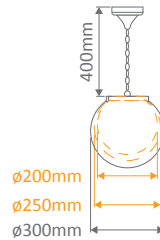

| Item No & Variant | | | Colour | Globe |
|-------------------|--------|--------|----------|-------|
| GT-535 | GT-536 | GT-537 | | |
| 15548 | 15554 | 15560 | Beige | 1xE27 |
| 15549 | 15555 | 15561 | Black | |
| 15550 | 15556 | 15562 | Burgundy | |
| 15551 | 15557 | 15563 | Green | |
| 15553 | 15559 | 15565 | White | |



GT-553 (250mm Sphere)
GT-554 (300mm Sphere)
Single Sphere on Post 950mm

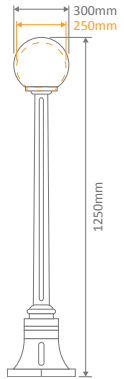

| Item No & Variant | | Colour | Globe |
|-------------------|--------|----------|-------|
| GT-553 | GT-554 | | |
| 15578 | 15584 | Beige | 1xE27 |
| 15579 | 15585 | Black | |
| 15580 | 15586 | Burgundy | |
| 15581 | 15587 | Green | |
| 15583 | 15589 | White | |

GT-567 (250mm Sphere)
GT-568 (300mm Sphere)
Twin Sphere on Post 1.1m

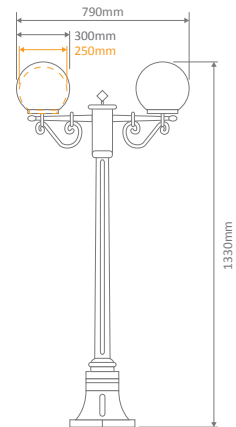

| Item No & Variant | | Colour | Globe |
|-------------------|--------|----------|-------|
| GT-567 | GT-568 | | |
| 15638 | 15644 | Beige | 2xE27 |
| 15639 | 15645 | Black | |
| 15640 | 15646 | Burgundy | |
| 15641 | 15647 | Green | |
| 15643 | 15649 | White | |



GT-555 (250mm Sphere)
GT-556 (300mm Sphere)
Single Sphere on Post 1.6m

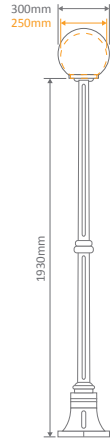

| Item No & Variant | | Colour | Globe |
|-------------------|--------|----------|-------|
| GT-555 | GT-556 | | |
| 15590 | 15596 | Beige | 1xE27 |
| 15591 | 15597 | Black | |
| 15592 | 15598 | Burgundy | |
| 15593 | 15599 | Green | |
| 15595 | 15601 | White | |

GT-569 (250mm Sphere)
GT-570 (300mm Sphere)
Twin Sphere on Post 1.75m

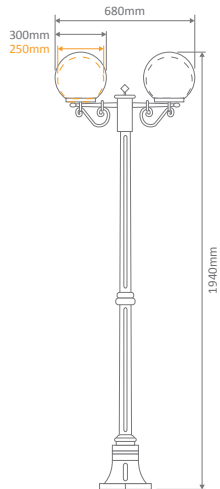

| Item No & Variant | | Colour | Globe |
|-------------------|--------|----------|-------|
| GT-569 | GT-570 | | |
| 15650 | 15656 | Beige | 2xE27 |
| 15651 | 15657 | Black | |
| 15652 | 15658 | Burgundy | |
| 15653 | 15659 | Green | |
| 15655 | 15661 | White | |



GT-557 (250mm Sphere)
GT-558 (300mm Sphere)
Single Sphere on Post 1.96m

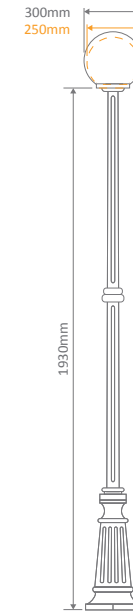

| Variant | | Colour | Globe |
|---------|--------|----------|-------|
| GT-557 | GT-558 | | |
| 15602 | 15608 | Beige | E27 |
| 15603 | 15609 | Black | |
| 15604 | 15610 | Burgundy | |
| 15605 | 15611 | Green | |
| 15607 | 15613 | White | |

Traditional Exterior

Traditional Exterior



Siena

GT-562 (250mm Sphere)
GT-563 (300mm Sphere)
Triple Spheres on Post 2.1m

GT-560 (250mm Sphere)
GT-561 (300mm Sphere)
Twin Spheres on Post 2.1m

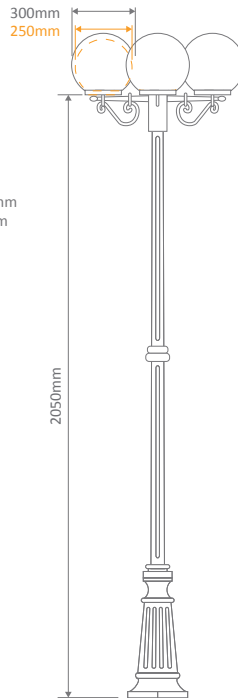

Width per model:
Double Head - 730mm
Triple Head - 700mm

| Item No & Variant | | | | Colour | Globe |
|-------------------|--------|--------|--------|----------|-------|
| GT-560 | GT-561 | GT-562 | GT-563 | | |
| 15614 | 15620 | 15626 | 15632 | Beige | E27* |
| 15615 | 15621 | 15627 | 15633 | Black | |
| 15616 | 15622 | 15628 | 15634 | Burgundy | |
| 15617 | 15623 | 15629 | 15635 | Green | |
| 15619 | 15625 | 15631 | 15637 | White | |

*The amount of globes needed will depend on the quantity of heads.



Vienna

Vienna



- Cast Aluminium, powder coated.
- Polycarbonate Diffuser.
- Made-To-Order. Production lead times apply.

GT-671 Wall Bracket
Straight Arm Facing Up

GT-672 Wall Bracket
Straight Arm Facing Down

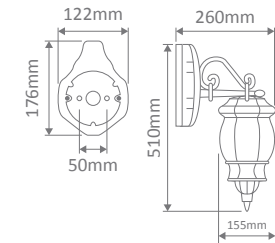
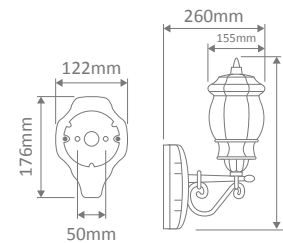

| Variant | Colour | Globe |
|---------|----------|-------|
| 15884 | Beige | 1xB22 |
| 15885 | Black | |
| 15886 | Burgundy | |
| 15887 | Green | |
| 15889 | White | |

| Variant | Colour | Globe |
|---------|----------|-------|
| 15890 | Beige | 1xB22 |
| 15891 | Black | |
| 15892 | Burgundy | |
| 15893 | Green | |
| 15895 | White | |

Traditional Exterior

Traditional Exterior



GT-1031 Wall Bracket
Curved Arm Facing Up

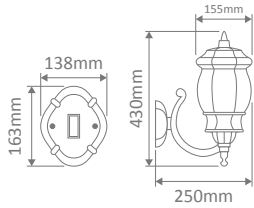

| Variant | Colour | Globe |
|---------|----------|-------|
| 15956 | Beige | 1xB22 |
| 15957 | Black | |
| 15958 | Burgundy | |
| 15959 | Green | |
| 15961 | White | |

GT-1032 Wall Bracket
Curved Arm Facing Down

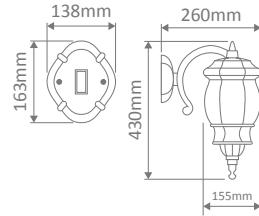

| Variant | Colour | Globe |
|---------|----------|-------|
| 15962 | Beige | 1xB22 |
| 15963 | Black | |
| 15964 | Burgundy | |
| 15965 | Green | |
| 15967 | White | |



GT-673 Pillar Mount

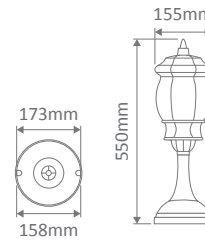

| Variant | Colour | Globe |
|---------|----------|-------|
| 15896 | Beige | 1xB22 |
| 15897 | Black | |
| 15898 | Burgundy | |
| 15899 | Green | |
| 15901 | White | |

GT-689 Post Top

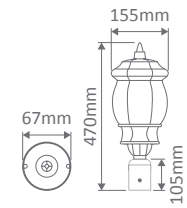

| Variant | Colour | Globe |
|---------|----------|-------|
| 15950 | Beige | 1xB22 |
| 15951 | Black | |
| 15952 | Burgundy | |
| 15953 | Green | |
| 15955 | White | |

GT-670 Single Pendant

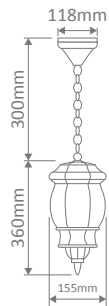

| Variant | Colour | Globe |
|---------|----------|-------|
| 15878 | Beige | 1xB22 |
| 15879 | Black | |
| 15880 | Burgundy | |
| 15881 | Green | |
| 15883 | White | |

Traditional Exterior



GT-674 Single Head Post on 1.31m



| Variant | Colour | Globe |
|---------|----------|-------|
| 15902 | Beige | 1xB22 |
| 15903 | Black | |
| 15904 | Burgundy | |
| 15905 | Green | |
| 15907 | White | |



GT-676 Single Head on Post 1.93m

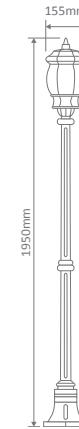

| Variant | Colour | Globe |
|---------|----------|-------|
| 15914 | Beige | 1xB22 |
| 15915 | Black | |
| 15916 | Burgundy | |
| 15917 | Green | |
| 15919 | White | |

GT-675 Twin Head on Post 1.46m

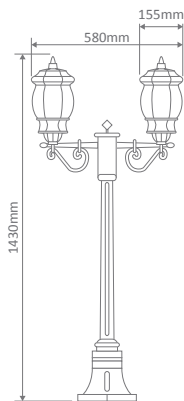

| Variant | Colour | Globe |
|---------|----------|-------|
| 15908 | Beige | 2xB22 |
| 15909 | Black | |
| 15910 | Burgundy | |
| 15911 | Green | |
| 15913 | White | |

GT-677 Double Head on Post 2.08m

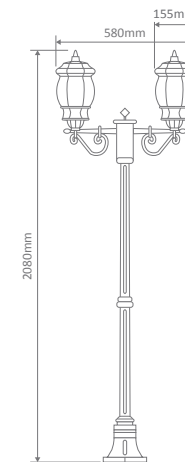

| Variant | Colour | Globe |
|---------|----------|-------|
| 15920 | Beige | 2xB22 |
| 15921 | Black | |
| 15922 | Burgundy | |
| 15923 | Green | |
| 15925 | White | |

Traditional Exterior

Traditional Exterior



GT-678 Single Head on Post 2.3m

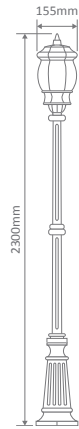

| Variant | Colour | Globe |
|---------|----------|-------|
| 15926 | Beige | 1xB22 |
| 15927 | Black | |
| 15928 | Burgundy | |
| 15929 | Green | |
| 15931 | White | |



GT-682 Triple Head on Post 2.44m

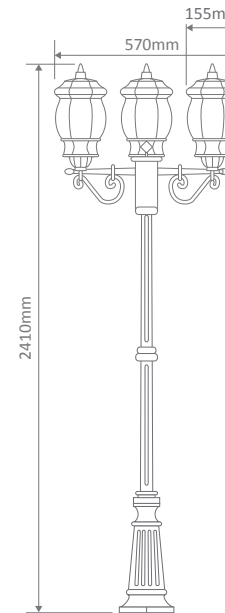

| Variant | Colour | Globe |
|---------|----------|-------|
| 15938 | Beige | 3xB22 |
| 15939 | Black | |
| 15940 | Burgundy | |
| 15941 | Green | |
| 15943 | White | |

GT-680 Twin Head on Post 2.44m

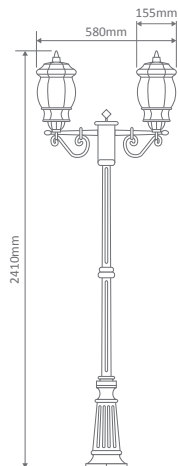

| Variant | Colour | Globe |
|---------|----------|-------|
| 15932 | Beige | 2xB22 |
| 15933 | Black | |
| 15934 | Burgundy | |
| 15935 | Green | |
| 15937 | White | |

Traditional Exterior

Traditional Exterior



GT-1044 Twin Curved Arm Head on Post 2.35m

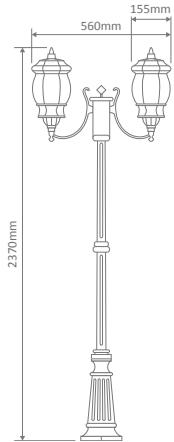

| Variant | Colour | Globe |
|---------|----------|--------|
| 15968 | Beige | 2x B22 |
| 15969 | Black | |
| 15970 | Burgundy | |
| 15971 | Green | |
| 15973 | White | |



Vienna Large Series



- Cast Aluminium, powder coated.
- Polycarbonate Diffuser.
- Made-To-Order. Production lead times apply.

GT-691 Large Wall Bracket



GT-692 Large Wall Bracket



GT-1045 Triple Curved Arm Head on Post 2.35m

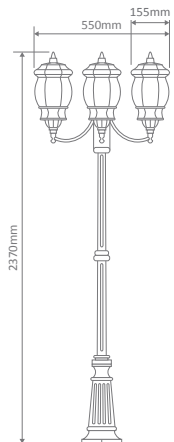

| Variant | Colour | Globe |
|---------|----------|--------|
| 15974 | Beige | 3x B22 |
| 15975 | Black | |
| 15976 | Burgundy | |
| 15977 | Green | |
| 15979 | White | |

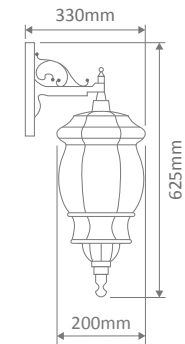
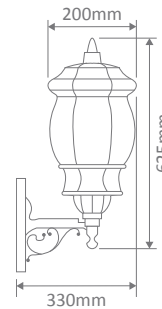

| Variant | Colour | Globe |
|---------|----------|--------|
| 15986 | Beige | 1x B22 |
| 15987 | Black | |
| 15988 | Burgundy | |
| 15989 | Green | |
| 15991 | White | |

| Variant | Colour | Globe |
|---------|----------|--------|
| 15992 | Beige | 1x B22 |
| 15993 | Black | |
| 15994 | Burgundy | |
| 15995 | Green | |
| 15997 | White | |

Traditional Exterior

Traditional Exterior



GT-694 Large Wall Bracket
Curved Arm Facing Up

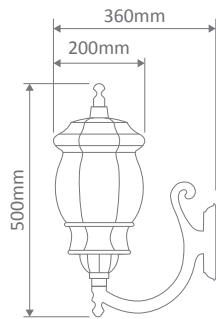

| Variant | Colour | Globe |
|---------|----------|-------|
| 16123 | Beige | 1xB22 |
| 16124 | Black | |
| 16125 | Burgundy | |
| 16126 | Green | |
| 16127 | White | |

GT-695 Large Wall Bracket
Curved Arm Facing Down

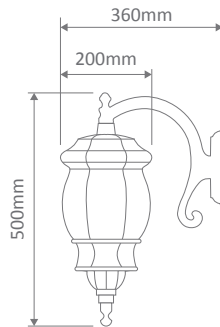

| Variant | Colour | Globe |
|---------|----------|-------|
| 16128 | Beige | 1xB22 |
| 16129 | Black | |
| 16130 | Burgundy | |
| 16131 | Green | |
| 16132 | White | |



GT-693 Large Pillar Mount



| Variant | Colour | Globe |
|---------|----------|-------|
| 15998 | Beige | 1xB22 |
| 15999 | Black | |
| 16000 | Burgundy | |
| 16001 | Green | |
| 16003 | White | |

GT-690 Large Pendant

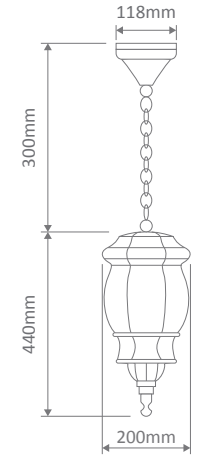

| Variant | Colour | Globe |
|---------|----------|-------|
| 15980 | Beige | 1xB22 |
| 15981 | Black | |
| 15982 | Burgundy | |
| 15983 | Green | |
| 15985 | White | |

GT-696 Large Post Top

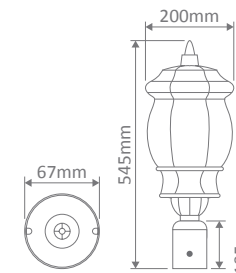

| Variant | Colour | Globe |
|---------|----------|-------|
| 16004 | Beige | 1xB22 |
| 16005 | Black | |
| 16006 | Burgundy | |
| 16007 | Green | |
| 16009 | White | |

Traditional Exterior

Traditional Exterior



Vienna Large

GT-698 Large Single Head on Post 2.4m

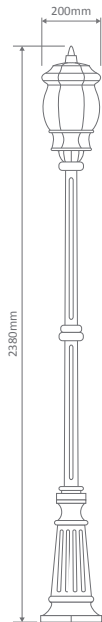

| Variant | Colour | Globe |
|---------|----------|-------|
| 16010 | Beige | 1xB22 |
| 16011 | Black | |
| 16012 | Burgundy | |
| 16013 | Green | |
| 16015 | White | |



Chester

Chester Series



- Cast Aluminium, powder coated.
- Polycarbonate Diffuser.
- Made-To-Order. Production lead times apply.

GT-131 Wall Bracket
Straight Arm Facing Up

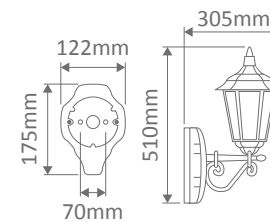

| Variant | Colour | Globe |
|---------|----------|-------|
| 14972 | Beige | 1xB22 |
| 14973 | Black | |
| 14974 | Burgundy | |
| 14975 | Green | |
| 14977 | White | |

GT-132 Wall Bracket
Straight Arm Facing Down

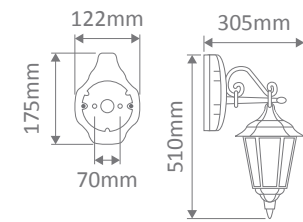

| Variant | Colour | Globe |
|---------|----------|-------|
| 14978 | Beige | 1xB22 |
| 14979 | Black | |
| 14980 | Burgundy | |
| 14981 | Green | |
| 14983 | White | |

Traditional Exterior

Traditional Exterior



GT-1073 Wall Bracket

Curved Arm Facing Up

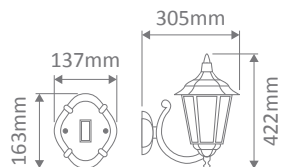

| Variant | Colour | Globe |
|---------|----------|-------|
| 15038 | Beige | 1xB22 |
| 15039 | Black | |
| 15040 | Burgundy | |
| 15041 | Green | |
| 15043 | White | |

GT-1074 Wall Bracket

Curved Arm Facing Down

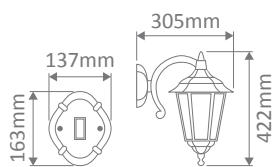

| Variant | Colour | Globe |
|---------|----------|-------|
| 15044 | Beige | 1xB22 |
| 15045 | Black | |
| 15046 | Burgundy | |
| 15047 | Green | |
| 15049 | White | |



GT-149 Post Top

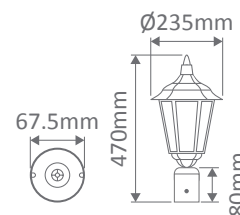

GT-130 Pendant

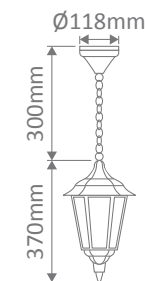

GT-133 Pillar Mount

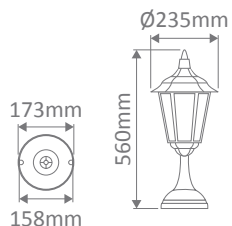

| Variant | Colour | Globe |
|---------|----------|-------|
| 14984 | Beige | 1xB22 |
| 14985 | Black | |
| 14986 | Burgundy | |
| 14987 | Green | |
| 14989 | White | |

| Variant | Colour | Globe |
|---------|----------|-------|
| 15032 | Beige | 1xB22 |
| 15033 | Black | |
| 15034 | Burgundy | |
| 15035 | Green | |
| 15037 | White | |

| Variant | Colour | Globe |
|---------|----------|-------|
| 14966 | Beige | 1xB22 |
| 14967 | Black | |
| 14968 | Burgundy | |
| 14969 | Green | |
| 14971 | White | |



GT-134 Single Head on Post 1.32m

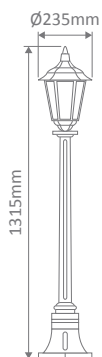

| Variant | Colour | Globe |
|---------|----------|-------|
| 14990 | Beige | 1xB22 |
| 14991 | Black | |
| 14992 | Burgundy | |
| 14993 | Green | |
| 14995 | White | |



GT-136 Single Head on Post 1.96m

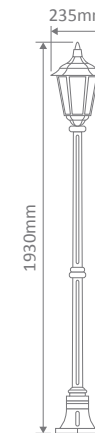

| Variant | Colour | Globe |
|---------|----------|-------|
| 15002 | Beige | 1xB22 |
| 15003 | Black | |
| 15004 | Burgundy | |
| 15005 | Green | |
| 15007 | White | |

GT-135 Twin Head on Post 1.49m

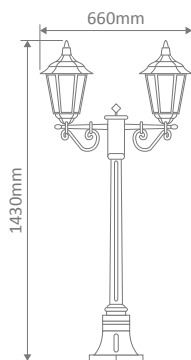

| Variant | Colour | Globe |
|---------|----------|-------|
| 14996 | Beige | 2xB22 |
| 14997 | Black | |
| 14998 | Burgundy | |
| 14999 | Green | |
| 15001 | White | |

GT-137 Twin Head on Post 2.11m

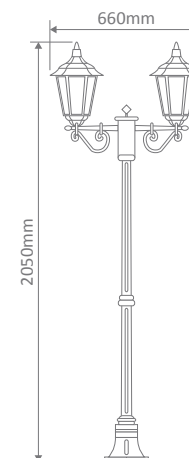

| Variant | Colour | Globe |
|---------|----------|-------|
| 15008 | Beige | 2xB22 |
| 15009 | Black | |
| 15010 | Burgundy | |
| 15011 | Green | |
| 15013 | White | |



GT-138 Single Head on Post 2.37m

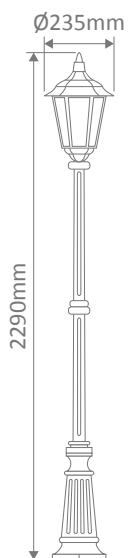

| Variant | Colour | Globe |
|---------|----------|-------|
| 15014 | Beige | 1xB22 |
| 15015 | Black | |
| 15016 | Burgundy | |
| 15017 | Green | |
| 15019 | White | |



GT-142 Triple Head on Post 2.47m



GT-140 Twin Head on Post 2.47m



Width per model:
Double Head - 660mm
Triple Head - 630mm

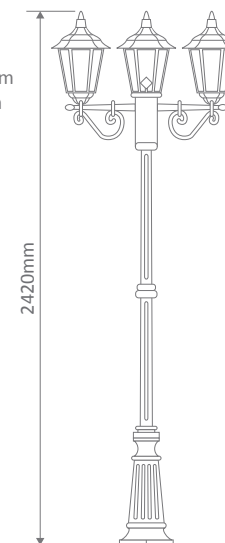

| Item No & Variant | | Colour | | Globe |
|-------------------|--------|----------|--|-------|
| GT-140 | GT-142 | | | B22* |
| 15020 | 15026 | Beige | | |
| 15021 | 15027 | Black | | |
| 15022 | 15028 | Burgundy | | |
| 15023 | 15029 | Green | | |
| 15025 | 15031 | White | | |

*The amount of globes needed will depend on the quantity of heads.

Traditional Exterior

Traditional Exterior



Chester

GT-1078 Triple Curved Arm Head on Post 2.4m

GT-1077 Twin Curved Arm Head on Post 2.4m



Width per model:
Double Head - 630mm
Triple Head - 590mm

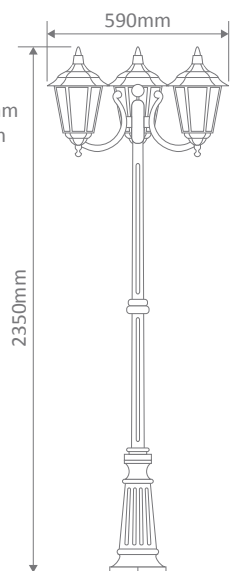

| Item No & Variant | | Colour | Globe |
|-------------------|---------|----------|-------|
| GT-1077 | GT-1078 | | |
| 15050 | 15056 | Beige | B22* |
| 15051 | 15057 | Black | |
| 15052 | 15058 | Burgundy | |
| 15053 | 15059 | Green | |
| 15055 | 15061 | White | |

*The amount of globes needed will depend on the quantity of heads.



Chester Large

Chester Large Series



- Cast Aluminium, powder coated.
- Polycarbonate Diffuser.
- Made-To-Order. Production lead times apply.

GT-161 Large Up Wall Bracket

GT-162 Large Down Wall Bracket

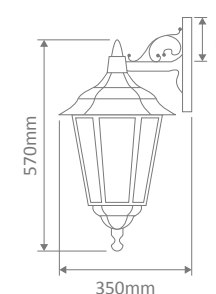
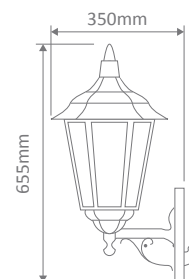

| Variant | Colour | Globe |
|---------|----------|-------|
| 15062 | Beige | 1xB22 |
| 15063 | Black | |
| 15064 | Burgundy | |
| 15065 | Green | |
| 15067 | White | |

| Variant | Colour | Globe |
|---------|----------|-------|
| 15068 | Beige | 1xB22 |
| 15069 | Black | |
| 15070 | Burgundy | |
| 15071 | Green | |
| 15073 | White | |

Traditional Exterior

Traditional Exterior



Chester Large

GT-171 Large Wall Bracket
Curved Arm Facing Up

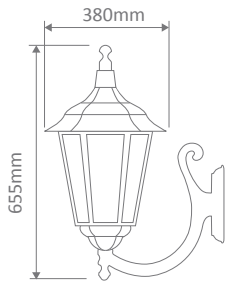

GT-172 Large Wall Bracket
Curved Arm Facing Down

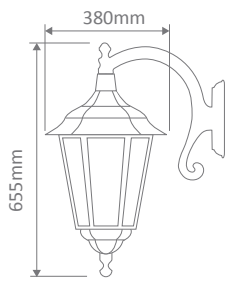

| Variant | Colour | Globe |
|---------|----------|-------|
| 15098 | Beige | 1xB22 |
| 15099 | Black | |
| 15100 | Burgundy | |
| 15101 | Green | |
| 15102 | White | |

| Variant | Colour | Globe |
|---------|----------|-------|
| 15103 | Beige | 1xB22 |
| 15104 | Black | |
| 15105 | Burgundy | |
| 15106 | Green | |
| 15107 | White | |



Chester Large

GT-163 Large Pillar Mount

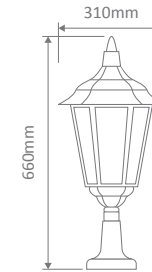

| Variant | Colour | Globe |
|---------|----------|-------|
| 15074 | Beige | 1xB22 |
| 15075 | Black | |
| 15076 | Burgundy | |
| 15077 | Green | |
| 15079 | White | |

GT-166 Large Post Top

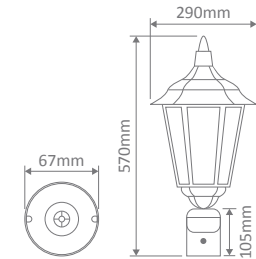

| Variant | Colour | Globe |
|---------|----------|-------|
| 15086 | Beige | 1xB22 |
| 15087 | Black | |
| 15088 | Burgundy | |
| 15089 | Green | |
| 15091 | White | |

GT-165 Large Pendant

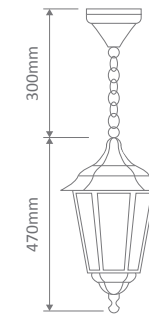

| Variant | Colour | Globe |
|---------|----------|-------|
| 15080 | Beige | 1xB22 |
| 15081 | Black | |
| 15082 | Burgundy | |
| 15083 | Green | |
| 15085 | White | |

Traditional Exterior

Traditional Exterior



Chester Large

GT-168 Single Head Post 2.45m

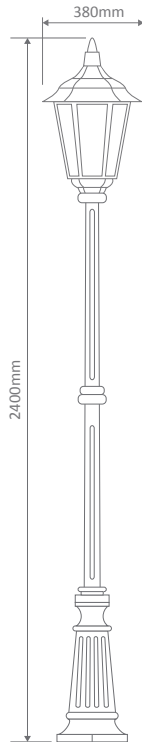

| Variant | Colour | Globe |
|---------|----------|-------|
| 15092 | Beige | 1xB22 |
| 15093 | Black | |
| 15094 | Burgundy | |
| 15095 | Green | |
| 15097 | White | |



Paris

Paris Series



- Cast Aluminium, powder coated.
- Polycarbonate Diffuser.
- Made-To-Order. Production lead times apply.

GT-231 Wall Bracket

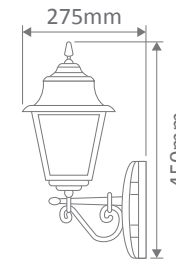

| Variant | Colour | Globe |
|---------|----------|-------|
| 15116 | Beige | 1xB22 |
| 15117 | Black | |
| 15118 | Burgundy | |
| 15119 | Green | |
| 15121 | White | |

GT-232 Wall Bracket

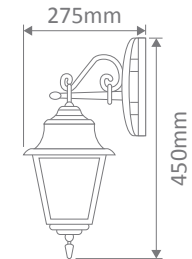

| Variant | Colour | Globe |
|---------|----------|-------|
| 15122 | Beige | 1xB22 |
| 15123 | Black | |
| 15124 | Burgundy | |
| 15125 | Green | |
| 15127 | White | |

Traditional Exterior

Traditional Exterior



Paris

GT-233 Pillar Mount

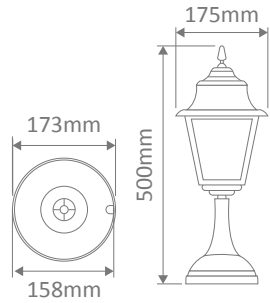

| Variant | Colour | Globe |
|---------|----------|-------|
| 15128 | Beige | 1xB22 |
| 15129 | Black | |
| 15130 | Burgundy | |
| 15131 | Green | |
| 15133 | White | |

GT-249 Post Top

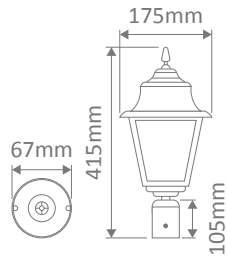

| Variant | Colour | Globe |
|---------|----------|-------|
| 15182 | Beige | 1xB22 |
| 15183 | Black | |
| 15184 | Burgundy | |
| 15185 | Green | |
| 15187 | White | |



Paris

GT-245 Wall Mounted

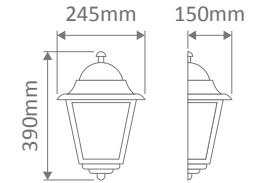

| Variant | Colour | Globe |
|---------|----------|-------|
| 15176 | Beige | 1xE27 |
| 15177 | Black | |
| 15178 | Burgundy | |
| 15179 | Green | |
| 15181 | White | |

GT-234 Single Head on Post 1.31m

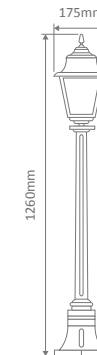

| Variant | Colour | Globe |
|---------|----------|-------|
| 15134 | Beige | 1xB22 |
| 15135 | Black | |
| 15136 | Burgundy | |
| 15137 | Green | |
| 15139 | White | |

GT-230 Pendant

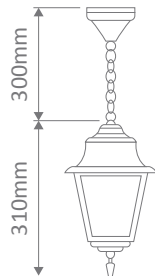

| Variant | Colour | Globe |
|---------|----------|-------|
| 15110 | Beige | 1xB22 |
| 15111 | Black | |
| 15112 | Burgundy | |
| 15113 | Green | |
| 15115 | White | |

Traditional Exterior

Traditional Exterior



Paris

GT-235 Twin Head on Post 1.46m

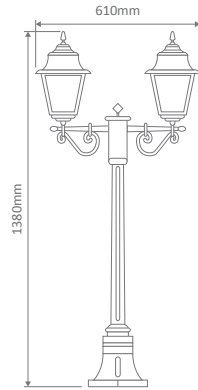

| Variant | Colour | Globe |
|---------|----------|-------|
| 15140 | Beige | 2xB22 |
| 15141 | Black | |
| 15142 | Burgundy | |
| 15143 | Green | |
| 15145 | White | |



Paris

GT-237 Twin Head on Post 2.09m

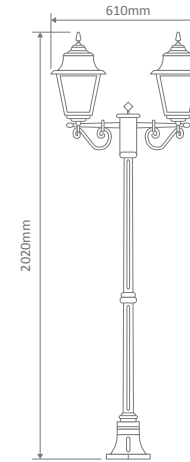

| Variant | Colour | Globe |
|---------|----------|-------|
| 15152 | Beige | 2xB22 |
| 15153 | Black | |
| 15154 | Burgundy | |
| 15155 | Green | |
| 15157 | White | |

GT-236 Single Head on Post 1.94m

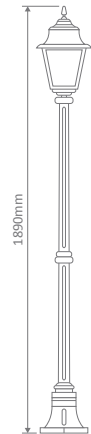

| Variant | Colour | Globe |
|---------|----------|-------|
| 15146 | Beige | 1xB22 |
| 15147 | Black | |
| 15148 | Burgundy | |
| 15149 | Green | |
| 15151 | White | |

GT-238 Single Head on Post 2.3m

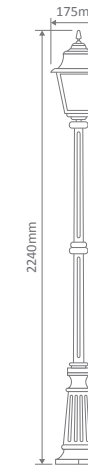

| Variant | Colour | Globe |
|---------|----------|-------|
| 15158 | Beige | 1xB22 |
| 15159 | Black | |
| 15160 | Burgundy | |
| 15161 | Green | |
| 15163 | White | |

Traditional Exterior

Traditional Exterior



Paris

GT-242 Triple Head on Post 2.45m



GT-240 Twin Head on Post 2.45m



Width per model:
Double Head - 610mm
Triple Head - 590mm

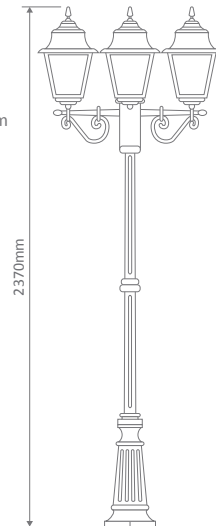

| Item No & Variant | | Colour | Globe |
|-------------------|--------|----------|-------|
| GT-240 | GT-242 | | |
| 15164 | 15170 | Beige | B22* |
| 15165 | 15171 | Black | |
| 15166 | 15172 | Burgundy | |
| 15167 | 15173 | Green | |
| 15169 | 15175 | White | |

*The amount of globes needed will depend on the quantity of heads.



Avignon

Avignon Series



- Cast Aluminium, powder coated.
- Polycarbonate Diffuser.
- Made-To-Order. Production lead times apply.

GT-271 Wall Bracket

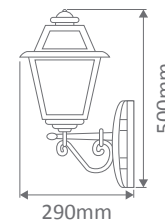

GT-272 Wall Bracket

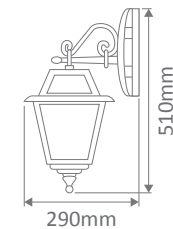

| Variant | Colour | Globe |
|---------|----------|-------|
| 15194 | Beige | 1xB22 |
| 15195 | Black | |
| 15196 | Burgundy | |
| 15197 | Green | |
| 15199 | White | |

| Variant | Colour | Globe |
|---------|----------|-------|
| 15200 | Beige | 1xB22 |
| 15201 | Black | |
| 15202 | Burgundy | |
| 15203 | Green | |
| 15205 | White | |

Traditional Exterior

Traditional Exterior



GT-273 Pillar Mount

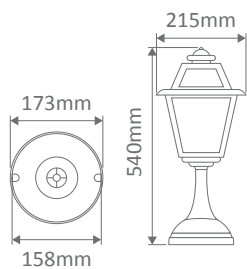

| Variant | Colour | Globe |
|---------|----------|-------|
| 15206 | Beige | 1xB22 |
| 15207 | Black | |
| 15208 | Burgundy | |
| 15209 | Green | |
| 15211 | White | |

GT-289 Post Top

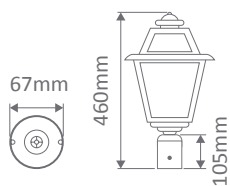

| Variant | Colour | Globe |
|---------|----------|-------|
| 15254 | Beige | 1xB22 |
| 15255 | Black | |
| 15256 | Burgundy | |
| 15257 | Green | |
| 15259 | White | |

GT-270 Pendant

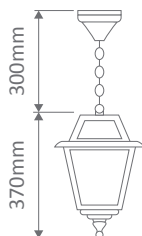

| Variant | Colour | Globe |
|---------|----------|-------|
| 15188 | Beige | 1xB22 |
| 15189 | Black | |
| 15190 | Burgundy | |
| 15191 | Green | |
| 15193 | White | |



GT-274 Single Head on Post 1.25m



| Variant | Colour | Globe |
|---------|----------|-------|
| 15212 | Beige | 1xB22 |
| 15213 | Black | |
| 15214 | Burgundy | |
| 15215 | Green | |
| 15217 | White | |

GT-275 Twin Head on Post 1.4m

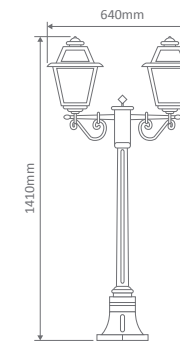

| Variant | Colour | Globe |
|---------|----------|-------|
| 15218 | Beige | 2xB22 |
| 15219 | Black | |
| 15220 | Burgundy | |
| 15221 | Green | |
| 15223 | White | |

Traditional Exterior

Traditional Exterior



GT-276 Single Head on Post 1.9m

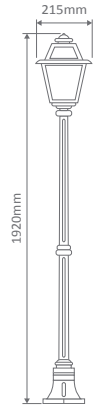

| Variant | Colour | Globe |
|---------|----------|-------|
| 15224 | Beige | 1xB22 |
| 15225 | Black | |
| 15226 | Burgundy | |
| 15227 | Green | |
| 15229 | White | |



GT-278 Single Head on Post 2.26m

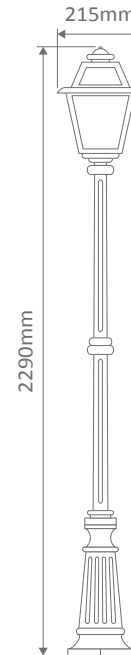

| Variant | Colour | Globe |
|---------|----------|-------|
| 15236 | Beige | 1xB22 |
| 15237 | Black | |
| 15238 | Burgundy | |
| 15239 | Green | |
| 15241 | White | |

GT-277 Twin Head on Post 2.05m

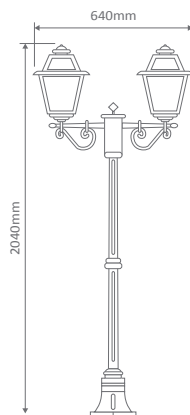

| Variant | Colour | Globe |
|---------|----------|-------|
| 15230 | Beige | 2xB22 |
| 15231 | Black | |
| 15232 | Burgundy | |
| 15233 | Green | |
| 15235 | White | |

Traditional Exterior

Traditional Exterior



Avignon

GT-282 Triple Head on Post 2.4m



GT-280 Twin Head on Post 2.4m



Width per model:
Double Head - 640mm
Triple Head - 620mm

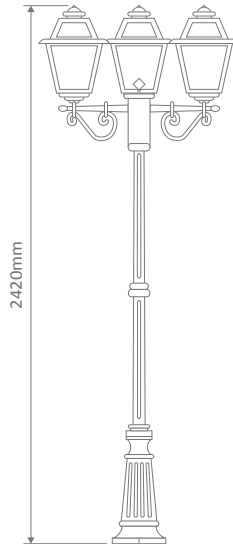

| Item No & Variant | | Colour | Globe |
|-------------------|--------|----------|-------|
| GT-280 | GT-282 | | |
| 15242 | 15248 | Beige | B22* |
| 15243 | 15249 | Black | |
| 15244 | 15250 | Burgundy | |
| 15245 | 15251 | Green | |
| 15247 | 15253 | White | |

*The amount of globes needed will depend on the quantity of heads.



Turin

Turin Series



- Cast Aluminium, powder coated.
- Polycarbonate Diffuser.
- Made-To-Order. Production lead times apply.

GT-421 Wall Bracket

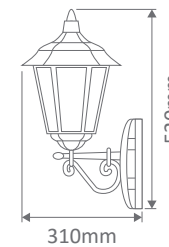

GT-422 Wall Bracket

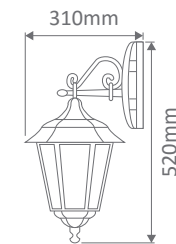

| Variant | Colour | Globe |
|---------|----------|-------|
| 15416 | Beige | 1xB22 |
| 15417 | Black | |
| 15418 | Burgundy | |
| 15419 | Green | |
| 15421 | White | |

| Variant | Colour | Globe |
|---------|----------|-------|
| 15422 | Beige | 1xB22 |
| 15423 | Black | |
| 15424 | Burgundy | |
| 15425 | Green | |
| 15427 | White | |

Traditional Exterior

Traditional Exterior



Turin

GT-423 Pillar Mount

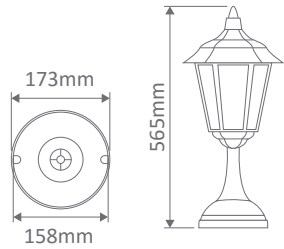

| Variant | Colour | Globe |
|---------|----------|-------|
| 15428 | Beige | 1xB22 |
| 15429 | Black | |
| 15430 | Burgundy | |
| 15431 | Green | |
| 15433 | White | |

GT-439 Post Top

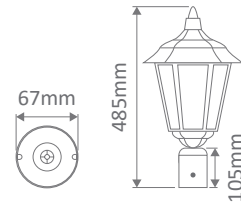

| Variant | Colour | Globe |
|---------|----------|-------|
| 15476 | Beige | 1xB22 |
| 15477 | Black | |
| 15478 | Burgundy | |
| 15479 | Green | |
| 15481 | White | |

GT-420 Pendant

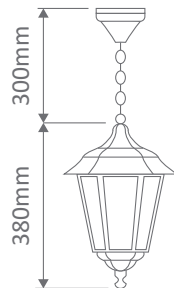

| Variant | Colour | Globe |
|---------|----------|-------|
| 15410 | Beige | 1xB22 |
| 15411 | Black | |
| 15412 | Burgundy | |
| 15413 | Green | |
| 15415 | White | |



Turin

GT-424 Single Head on Post 1.32m



| Variant | Colour | Globe |
|---------|----------|-------|
| 15434 | Beige | 1xB22 |
| 15435 | Black | |
| 15436 | Burgundy | |
| 15437 | Green | |
| 15439 | White | |

GT-425 Twin Head on Post 1.49m

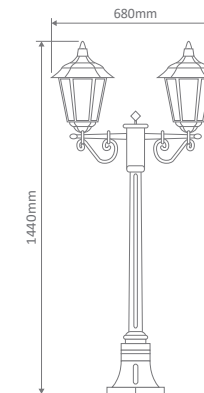

| Variant | Colour | Globe |
|---------|----------|-------|
| 15440 | Beige | 2xB22 |
| 15441 | Black | |
| 15442 | Burgundy | |
| 15443 | Green | |
| 15445 | White | |

Traditional Exterior

Traditional Exterior



Turin

GT-426 Single Head on Post 1.96m

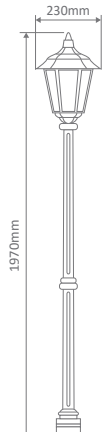

| Variant | Colour | Globe |
|---------|----------|-------|
| 15446 | Beige | 1xB22 |
| 15447 | Black | |
| 15448 | Burgundy | |
| 15449 | Green | |
| 15451 | White | |



Turin

GT-428 Single Head on Post 2.37m

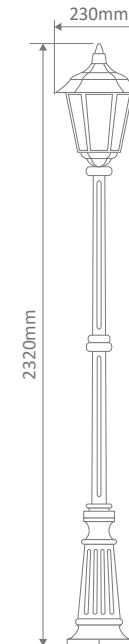

| Variant | Colour | Globe |
|---------|----------|-------|
| 15458 | Beige | 1xB22 |
| 15459 | Black | |
| 15460 | Burgundy | |
| 15461 | Green | |
| 15463 | White | |

GT-427 Twin Head on Post 2.11m

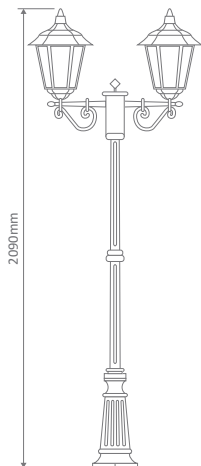

| Variant | Colour | Globe |
|---------|----------|-------|
| 15452 | Beige | 2xB22 |
| 15453 | Black | |
| 15454 | Burgundy | |
| 15455 | Green | |
| 15457 | White | |

Traditional Exterior

Traditional Exterior



Turin

GT-432 Triple Head on Post 2.4m

GT-430 Twin Head on Post 2.47m

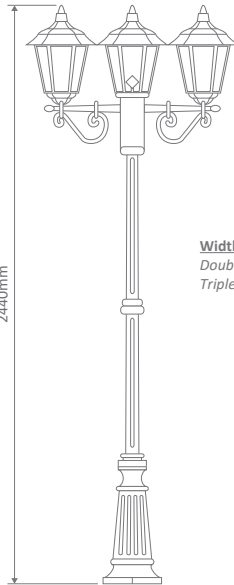

Width per model:
Double Head - 680mm
Triple Head - 660mm

| Item No & Variant | | Colour | Globe |
|-------------------|--------|----------|-------|
| GT-430 | GT-432 | | |
| 15464 | 15470 | Beige | B22* |
| 15465 | 15471 | Black | |
| 15466 | 15472 | Burgundy | |
| 15467 | 15473 | Green | |
| 15469 | 15475 | White | |

*The amount of globes needed will depend on the quantity of heads.



Turin Large

Turin Large Series



- Cast Aluminium, powder coated.
- Polycarbonate Diffuser.

GT-481 Large Wall Bracket

GT-482 Large Wall Bracket

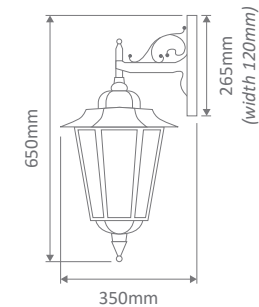
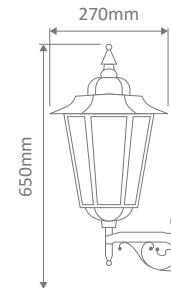

| Variant | Colour | Globe |
|---------|----------|-------|
| 15482 | Beige | 1xB22 |
| 15483 | Black | |
| 15484 | Burgundy | |
| 15485 | Green | |
| 15487 | White | |

| Variant | Colour | Globe |
|---------|----------|-------|
| 15488 | Beige | 1xB22 |
| 15489 | Black | |
| 15490 | Burgundy | |
| 15491 | Green | |
| 15493 | White | |

Traditional Exterior

Traditional Exterior



Turin Large

GT-491 Large Up Curved Wall Bracket

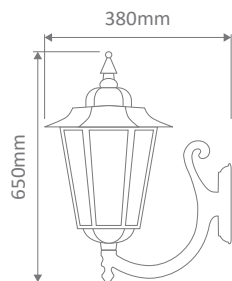

GT-492 Up Large Curved Wall Bracket

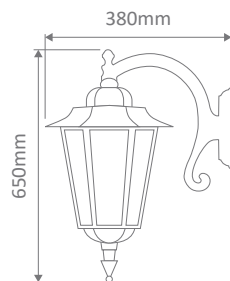

Turin Large

GT-483 Large Pillar Mount

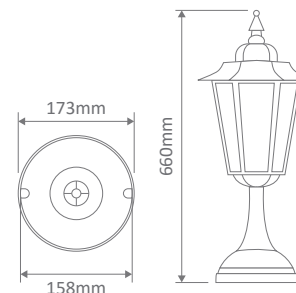

| Variant | Colour | Globe |
|---------|----------|-------|
| 15494 | Beige | 1xB22 |
| 15495 | Black | |
| 15496 | Burgundy | |
| 15497 | Green | |
| 15499 | White | |

GT-486 Large Post Top

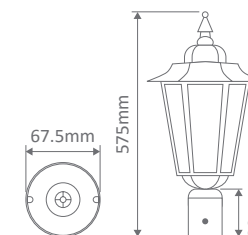

| Variant | Colour | Globe |
|---------|----------|-------|
| 15506 | Beige | 1xB22 |
| 15507 | Black | |
| 15508 | Burgundy | |
| 15509 | Green | |
| 15511 | White | |

GT-485 Large Pendant

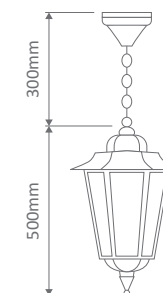

| Variant | Colour | Globe |
|---------|----------|-------|
| 16133 | Beige | 1xB22 |
| 16134 | Black | |
| 16135 | Burgundy | |
| 16136 | Green | |
| 16137 | White | |

| Variant | Colour | Globe |
|---------|----------|-------|
| 16138 | Beige | 1xB22 |
| 16139 | Black | |
| 16140 | Burgundy | |
| 16141 | Green | |
| 16142 | White | |

| Variant | Colour | Globe |
|---------|----------|-------|
| 15500 | Beige | 1xB22 |
| 15501 | Black | |
| 15502 | Burgundy | |
| 15503 | Green | |
| 15505 | White | |

Traditional Exterior

Traditional Exterior



GT-488 Single Head on Post 2.45m

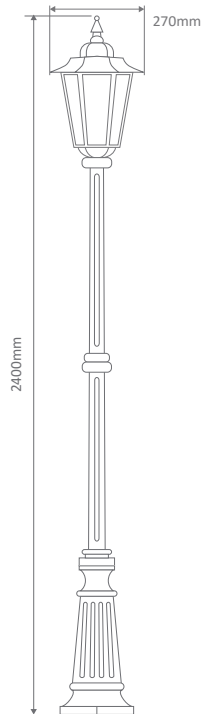

| Variant | Colour | Globe |
|---------|----------|-------|
| 15512 | Beige | 1xB22 |
| 15513 | Black | |
| 15514 | Burgundy | |
| 15515 | Green | |
| 15517 | White | |



Mounting Adaptors



GTA-95
CTC Bracket



GTA-96
Pillar Mount Base



GTA-832
Base & Adaptor Plate

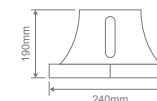

GTA-833
Base

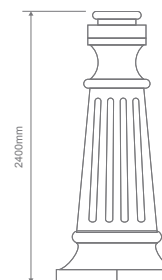

| Item No & Variant | | | | Colour | |
|-------------------|--------|---------|---------|----------|----------|
| GTA-95 | GTA-96 | GTA-832 | GTA-833 | | |
| 16075 | 16081 | 16063 | 16144 | Beige | Beige |
| 16076 | 16082 | 16064 | 16145 | Black | Black |
| 16077 | 16083 | 16065 | 16146 | Burgundy | Burgundy |
| 16078 | 16084 | 16066 | 16147 | Green | Green |
| 16080 | 16086 | 16068 | 16148 | White | White |

Post Top Adaptors



GTA-140 43mm



GTA-141 50mm



GTA-142 60mm



GTA-150, 151, 152
(76mm, 80mm, 82mm)

| Item No & Variant | | | | | | Colour | |
|-------------------|---------|---------|---------|---------|---------|----------|----------|
| GTA-140 | GTA-141 | GTA-142 | GTA-150 | GTA-151 | GTA-152 | | |
| 16021 | 16027 | 16033 | 16103 | 16113 | 16119 | Beige | Beige |
| 16022 | 16028 | 16034 | 16104 | 16114 | 16120 | Black | Black |
| 16023 | 16029 | 16035 | 16105 | 16115 | 16121 | Burgundy | Burgundy |
| 16024 | 16030 | 16036 | 16106 | 16116 | 16122 | Green | Green |
| 16026 | 16032 | 16038 | 16102 | 16112 | 16118 | White | White |

Traditional Exterior

Traditional Exterior



Accessories



GTA-72
Monaco Series Diffuser Ring

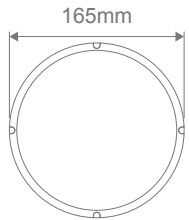

GTA-652
Monaco Series Diffuser Only

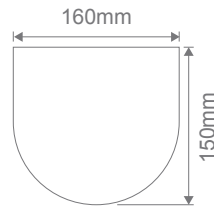

GTA-94
Thread Adaptor Plate

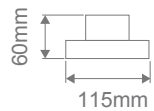

| Item No & Variant | | | Colour | |
|-------------------|--------------|--------------|--------|----------|
| GTA-72 | GTA-652 | GTA-94 | | |
| N/A | N/A | 16069 | | Beige |
| 16089 | N/A | 16070 | | Black |
| N/A | N/A | 16071 | | Burgundy |
| N/A | N/A | 16072 | | Green |
| N/A | N/A | 16074 | | White |
| | 16098 | | | Clear |



Accessories



GTA-222 95cm Post
GTA-221 1.57m Post
GTA-220 1.93m Post

| Item No & Variant | | | Colour | |
|-------------------|--------------|--------------|--------|----------|
| GTA-220 | GTA-221 | GTA-222 | | |
| 16039 | 16045 | 16051 | | Beige |
| 16040 | 16046 | 16052 | | Black |
| 16041 | 16047 | 16053 | | Burgundy |
| 16042 | 16048 | 16054 | | Green |
| 16044 | 16050 | 16056 | | White |
| N/A | N/A | N/A | | Clear |

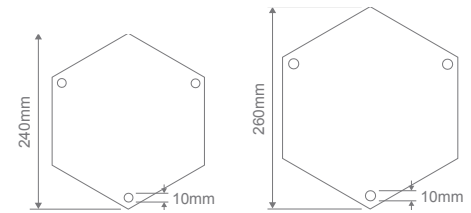

GTA-222-221 (Base)
GTA-220 (Base)



GTA-335
Exterior Arm

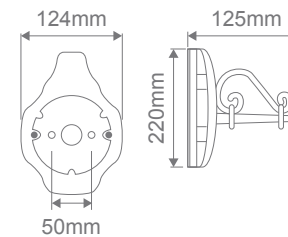

GTA-98
Cap to Suit 60mm Post

| Item No & Variant | | Colour | |
|-------------------|--------------|--------|----------|
| GTA-335 | GTA-98 | | |
| 16057 | N/A | | Beige |
| 16058 | 16087 | | Black |
| 16059 | N/A | | Burgundy |
| 16060 | N/A | | Green |
| 16062 | 16088 | | White |



WP-12V Series

- 12V DC Constant Voltage.



WP12-10W
WP12-15W

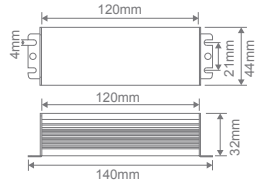

WP12-30W

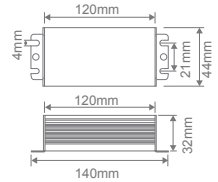

WP12-60W

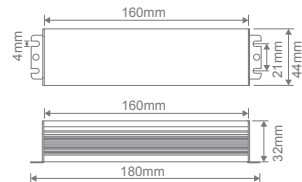

WP12-100W

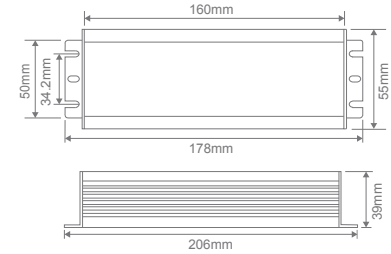

WP12-150W

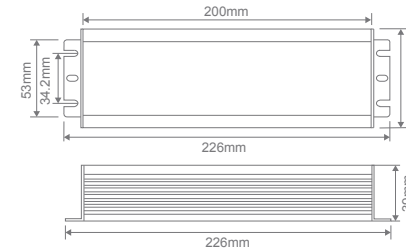

WP12-200W
WP12-250W

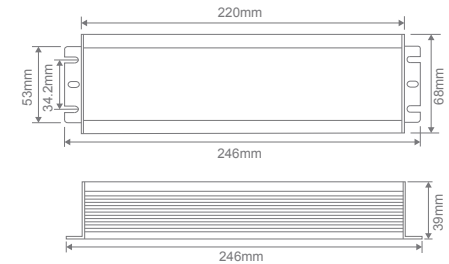

| Item No. | Variant | Input Voltage | Output Voltage | Output Wattage | IP Rating |
|----------|---------|-----------------------|----------------|----------------|-----------|
| WP12/10 | 20198 | 200-260V (50/60Hz) | 12V | 1-10W | 67 |
| WP12/15 | 20200 | | | 1.5-15W | |
| WP12/30 | 20201 | | | 3-30W | |
| WP12/60 | 20202 | | | 6-60W | |

Constant Voltage - Wire in Parallel



| Item No. | Variant | Input Voltage | Output Voltage | Output Wattage | IP Rating |
|----------|---------|-----------------------|----------------|----------------|-----------|
| WP12/100 | 20203 | 200-260V (50/60Hz) | 12V | 10-100W | 67 |
| WP12/150 | 20204 | | | 15-150W | |
| WP12/200 | 20199 | | | 20-200W | |
| WP12/250 | 20259 | | | 25-250W | |

Constant Voltage - Wire in parallel

Power Supplies

Power Supplies



WP-24V Series

- 24V DC Constant Voltage.



WP24-10W
WP24-15W

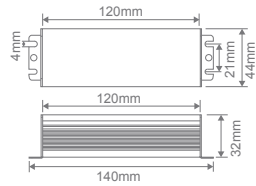

WP24-30W

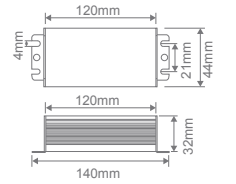

WP24-60W

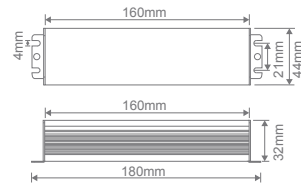

WP24-100W

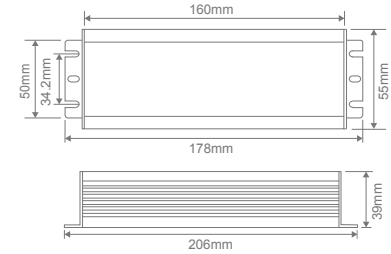

WP24-150W

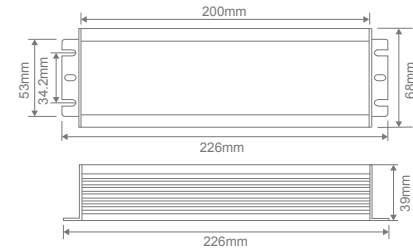

WP24-200W
WP24-250W

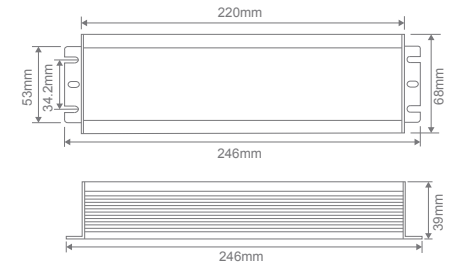

| Item No. | Variant | Input Voltage | Output Voltage | Output Wattage | IP Rating |
|----------|---------|-----------------------|----------------|----------------|-----------|
| WP24/10 | 20249 | 200-260V (50/60Hz) | 24V | 1-10W | 67 |
| WP24/15 | 20250 | | | 1.5-15W | |
| WP24/30 | 20251 | | | 3-30W | |
| WP24/60 | 20252 | | | 6-60W | |

Constant Voltage - Wire in parallel

| Item No. | Variant | Input Voltage | Output Voltage | Output Wattage | IP Rating |
|----------|---------|-----------------------|----------------|----------------|-----------|
| WP24/100 | 20253 | 200-260V (50/60Hz) | 24V | 10-100W | 67 |
| WP24/150 | 20254 | | | 15-150W | |
| WP24/200 | 20257 | | | 20-200W | |
| WP24/250 | 20258 | | | 25-250W | |

Constant Voltage - Wire in parallel

Power Supplies

Power Supplies





WP-350mA Series

- 350mA Constant Current.



WP350mA-3
WP350mA-10
WP350mA-20

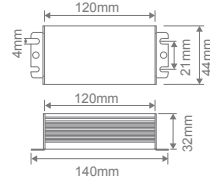

WP-700mA Series

- 700mA Constant Current.



WP700mA-3
WP700mA-10
WP700mA-20

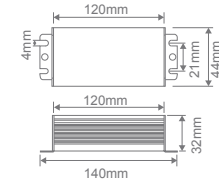

| Item No. | Variant | Input Voltage | Output Voltage | Output Current | Wattage | IP Rating |
|------------|---------|--------------------------|----------------|----------------|---------|-----------|
| WP350MA/3 | 20248 | 200-260V AC (50/60Hz) | 7-9V | 350mA | 2.5-3W | 67 |
| WP350MA/10 | 20255 | | 26-30V | | 9-10W | |
| WP350MA/20 | 20260 | | 40-57V | | 14-20W | |

Constant Current - Wire in Series

| Item No. | Variant | Input Voltage | Output Voltage | Output Current | Wattage | IP Rating |
|------------|---------|--------------------------|----------------|----------------|----------|-----------|
| WP700MA/3 | 20393 | 200-260V AC (50/60Hz) | 3-5V | 700mA | 2-3W | 67 |
| WP700MA/10 | 20395 | | 12-15V | | 8.5-10W | |
| WP700MA/20 | 20256 | | 25-30V | | 17.5-20W | |

Constant Current - Wire in Series

Evac D63 Recessed



Evac D63 Surface Mounted



EVAC Series



| | Evac-SM | Evac-REC |
|-----------------|--|--|
| Input Voltage: | 240V AC | |
| Wattage: | 3.5w Power Consumption | |
| CCT: | 4500K | |
| Emergency: | Non- Maintained | |
| Classification: | D63 | |
| Battery: | LiFePO4 (Charge time 24hrs) | |
| Terminal: | Large Terminal, PA16 | Flex and Plug |
| Features: | 180x180x52mm pressed steel, overcharge & discharge protection, polarity reversal protection for battery. | Adjustable dish 95/145mm, depth 34mm, overcharge & discharge protection, polarity reversal protection for battery. |
| Warranty: | 4 Year Warranty including battery | |
| Compliance: | Fully Compliant to AS/NZS2293.3 | |

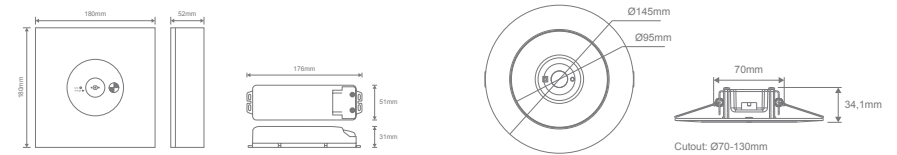

| Item No. | Variants | Wattage | CCT |
|--------------------|--------------|---------|-------|
| EVAC-SM-WHT | 66044 | 3.5W | 4500K |
| EVAC-SM-BLK | 66045 | | |

| Item No. | Variants | Wattage | CCT |
|---------------------|--------------|---------|-------|
| EVAC-REC-WHT | 66040 | 3.5W | 4500K |
| EVAC-REC-BLK | 66041 | | |



Exit Surface Mount Series



Exit Surface Mount Series



| | |
|----------------|---|
| Input Voltage: | 240V AC |
| Wattage: | 3.5W Power Consumption |
| CCT: | 6000K |
| Emergency: | Maintained / Non- Maintained |
| Battery: | LiFePO4 (Charge time 24hrs) |
| Terminal: | Large Terminal, PA16 |
| Features: | 24m Viewing distance, surface mounted, Easy quick slide installation, all directional inserts included in the box, Overcharge & discharge protection, Polarity reversal protection for battery, wall, ceiling, chain and rod mounting (with Rod Mount Kit) options available. |
| Warranty: | 4 Year Warranty including battery |
| Compliance: | Fully Compliant to AS/NZS2293.3 |

| Item No. | Variants | | Wattage | CCT |
|-------------------|--------------|--------------|---------|-------|
| | Blk | Wht | | |
| EXIT-SM-24 | 66100 | 66101 | 3.5W | 4500K |

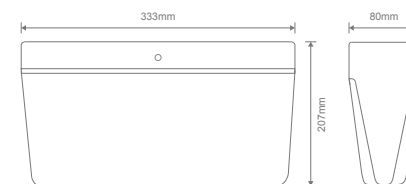

| Accessories | Variants | | IP Rating |
|--------------------|----------|-------|-----------|
| | Wht | Blk | |
| EXIT-WPBOX | 66102 | N/A | IP65 |
| EXIT-SM-ROD-MT-KIT | 66124 | 66125 | N/A |



EXIT-WPBOX



EXIT-SM-ROD-MT-KIT



Exit Recessed Mount Series



Emergency



Exit Recessed Mount Series



| | |
|----------------|---|
| Input Voltage: | 240V AC |
| Wattage: | 4W Power Consumption |
| CCT: | 5000K |
| Emergency: | Maintained / Non- Maintained |
| Battery: | LiFePO4 (Charge time 24hrs) |
| Terminal: | Large Terminal, PA16 |
| Features: | 24m Viewing distance, recessed mounted, all directional inserts included in the box, Overcharge & discharge protection, Polarity reversal protection for battery, Flex and Plug, surface mount box available. |
| Warranty: | 4 Year Warranty including battery |
| Compliance: | Fully Compliant to AS/NZS2293.3 |

| Item No. | Variants | | Wattage | CCT |
|--------------------|--------------|--------------|---------|-------|
| | Blk | Wht | | |
| EXIT-REC-24 | 66104 | 66105 | 4W | 4500K |

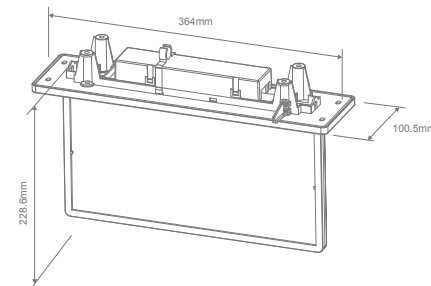

| Add-ons | Variants | |
|-----------------|--------------|--------------|
| | Wht | Blk |
| EXIT-REC-SM-KIT | 66188 | 66189 |
| EXIT-REC-PLATE | 66121 | 66122 |



EXIT-REC-SM-KIT

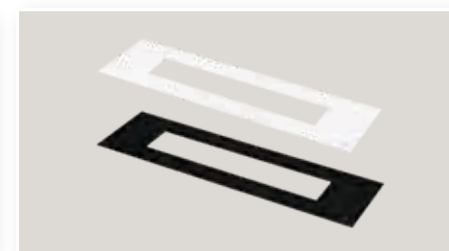

EXIT-REC-PLATE

Emergency



Evac D40 Mini



| | |
|---------------------|-----------------------------------|
| Input Voltage: | 240V AC |
| Wattage: | 1.8W |
| Emergency | Non-Maintained |
| CCT: | 4000K |
| Classification: | D40 |
| LED Type | COB |
| Beam Angle (°) | 120° |
| Emergency Duration: | 3hrs |
| Battery: | LiFePO4 3.2V 3.6Ah |
| Mounting: | Recessed Mounting |
| Warranty: | 5 Year Warranty including battery |
| Compliance: | Fully Compliant to AS/NZS2293.3 |

EVAC-D40-MINI products are all self test

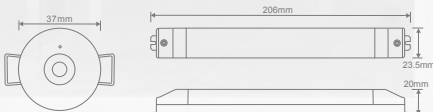

| Item No. | Variants | CCT |
|-------------------|----------|-------|
| EVAC-D40-MINI-WHT | 66047 | 4000K |
| EVAC-D40-MINI-BLK | 66048 | |

Trak 3 EM D40



| | |
|---------------------|-----------------------------------|
| Input Voltage: | 240V AC |
| Wattage: | 3W |
| Emergency | Non-Maintained |
| CCT: | 4000K |
| Classification: | D40 |
| LED Type | COB |
| Beam Angle (°) | 120° |
| Emergency Duration: | 3hrs |
| Battery: | LiFePO4 3.2V 3.6Ah |
| Mounting: | 3-Circuit Track |
| Warranty: | 5 Year Warranty including battery |
| Compliance: | Fully Compliant to AS/NZS2293.3 |

TRAK-3-EM-D40 products are all self test.

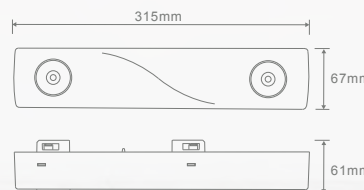

| Item No. | Variants | CCT |
|-------------------|----------|-------|
| TRAK-3-EM-D40-WHT | 66097 | 4000K |
| TRAK-3-EM-D40-BLK | 66096 | |

Twin Spot EM



Twin Spot EM

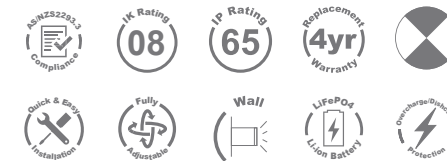

| | |
|----------------------|--|
| Input Voltage: | 240V AC |
| Wattage: | 2.5W/5W |
| Lumens: | (2.5W) White 6500K - 200lm (5W) White 6500K - 400lm |
| IP Rating: | IP65 |
| Frequency: | 60Hz |
| Charge Time: | 24hrs |
| Emergency Time: | 2/3hrs |
| Operation: | Non-Maintained |
| Function: | Manual Test Switch & LED Indicator |
| Working Temperature: | 0-40°C |
| Battery: | LiFePO4 |
| Mounting: | Wall Mounted |
| Warranty: | 4 Year Warranty Including Battery |
| Compliance: | Fully Compliant to AS/NZS2293.3 |

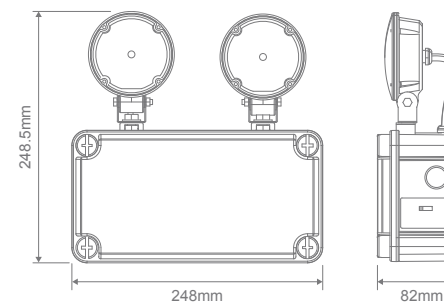

| Item No. | Variants | CCT |
|------------------|----------|-------|
| TWIN-SPOT-EM-WHT | 66108 | 6500K |
| TWIN-SPOT-EM-BLK | 66109 | |



Sunset Series



Sensor Remote Control (Sold Separately)



Note: One remote control will operate unlimited sensors.

| | |
|------------|---------|
| Item No. | Variant |
| SUNSET-REM | 66133 |



Sunset Series



| | |
|-------------------|---------------------------------|
| Input Voltage: | 240V AC |
| Wattage: | 25W |
| LED: | SMD |
| IP Rating: | IP54 |
| Class: | Class II (No Earth Required) |
| CRI: | ≥80 |
| Lifespan: | 50,000hrs |
| Dimmable: | No |
| Beam Angle: | 120° |
| Emergency Kits: | Built-In |
| Microwave Sensor: | Yes |
| Warranty: | 4 Year Warranty |
| Compliance: | Fully Compliant to AS/NZS2293.3 |

SUNSET-300-EM is self test

| Item No. | Variants | CCT | Lumen Output | | |
|-----------------------|----------|------|------------------|---------------------|-------------|
| | | | Warm White 3000K | Neutral White 4000K | White 5000K |
| SUNSET-300-RND-EM | 66132 | TRIO | 2370lm | 2485lm | 2600lm |
| SUNSET-300-RND-EM-SEN | 66130 | | | | |

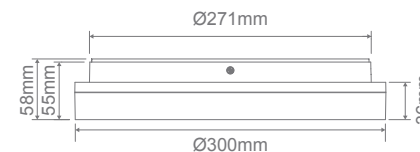

| | |
|-------------------------|-------------------|
| Green Indicator | Charge END |
| Yellow Indicator | Battery Charging |
| Red Indicator | Emergency Status |
| Green + Yellow Flashing | Battery Fault |
| Green + Yellow OFF | Battery Over Temp |



Emergency Test Buttons



Emergency Systems



Emergency Systems

Park Series Emergency Park Light



Park-DIFF

Park-WG

Accessories (Sold Separately)



SENSOR-INT-01-ON-OFF

SENSOR-INT-01-DIM

Note: One remote control will operate unlimited sensors.

Emergency

Emergency



Park Diffuser Series

| | | |
|----------------|--|----------|
| | Park-60 | Park-120 |
| Input Voltage: | 240V AC | |
| Wattage: | 7.5W/15W | 15W/30W |
| Emergency: | Maintained / Non- Maintained | |
| Cover: | Prismatic Diffuser with even light output | |
| Battery: | LiFePO4 (Charge time 24hrs) | |
| Terminal: | Large Terminal, PA16 | |
| Features: | 20mm Knockouts for conduit or cable glands. | |
| Options: | ON/OFF and DIMMABLE Internal Sensor available. Remote control required for sensor adjustment. One remote control will operate unlimited sensors. Remote control sold separately. DALI and TRIAC options available. | |
| Warranty: | 5 Year Warranty / 3 Year Warranty on Battery | |
| Compliance: | Fully Compliant to AS/NZS2293.3 | |

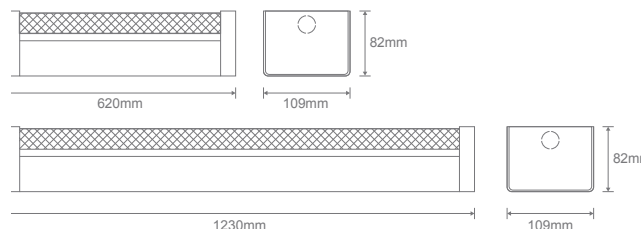

| Item No. | Variants | | CCT | Non-Dim | ON/OFF Sensor | DIM Sensor | Lumen Output | | |
|------------------|----------|----------|------|---------|---------------|------------|------------------|---------------------|----------------|
| | EM | Standard | | | | | Warm White 3000K | Neutral White 4000K | White 5000K |
| PARK-60-DIFF-EM | 66070 | 66050 | TRIO | ● | - | - | 950lm /1800lm | 1000lm /1950lm | 1000lm /1850lm |
| | 66071 | 66051 | | - | ● | - | | | |
| | 66072 | 66052 | | - | - | ● | | | |
| PARK-120-DIFF-EM | 66073 | 66053 | TRIO | ● | - | - | 2050lm /3850lm | 2100lm /4050lm | 2050lm /3900lm |
| | 66074 | 66054 | | - | ● | - | | | |
| | 66075 | 66055 | | - | - | ● | | | |



Park Wire Guard Series

| | | |
|----------------|--|----------|
| | Park-60 | Park-120 |
| Input Voltage: | 240V AC | |
| Wattage: | 7.5W/15W | 15W/30W |
| Emergency: | Maintained / Non- Maintained | |
| Cover: | Wire Guard with even light output | |
| Battery: | LiFePO4 (Charge time 24hrs) | |
| Terminal: | Large Terminal, PA16 | |
| Features: | 20mm Knockouts for conduit or cable glands. | |
| Options: | ON/OFF and DIMMABLE Internal Sensor available. Remote control required for sensor adjustment. One remote control will operate unlimited sensors. Remote control sold separately. DALI and TRIAC options available. | |
| Warranty: | 5 Year Warranty / 3 Year Warranty on Battery | |
| Compliance: | Fully Compliant to AS/NZS2293.3 | |

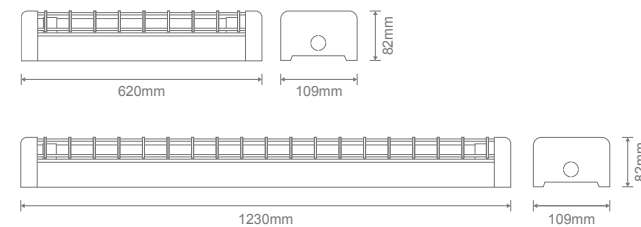

| Item No. | Variants | | CCT | Non-Dim | ON/OFF Sensor | DIM Sensor | Lumen Output | | |
|----------------|----------|----------|------|---------|---------------|------------|------------------|---------------------|----------------|
| | EM | Standard | | | | | Warm White 3000K | Neutral White 4000K | White 5000K |
| PARK-60-WG-EM | 66080 | 66060 | TRIO | ● | - | - | 850lm /1580lm | 900lm /1700lm | 900lm /1650lm |
| | 66081 | 66061 | | - | ● | - | | | |
| | 66082 | 66062 | | - | - | ● | | | |
| PARK-120-WG-EM | 66083 | 66063 | TRIO | ● | - | - | 1800lm /3400lm | 1800lm /3550lm | 1800lm /3450lm |
| | 66084 | 66064 | | - | ● | - | | | |
| | 66085 | 66065 | | - | - | ● | | | |

Emergency

Emergency



Hydro Series

Accessories (Sold Separately)

SENSOR-INT-01-ON-OFF

SENSOR-INT-01-DIM

Note: One remote control will operate unlimited sensors.

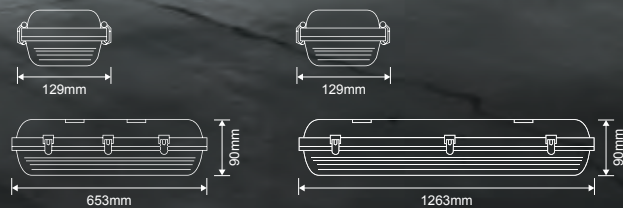

Hydro Weatherproof Series



| | Hydro-60 | Hydro-120 |
|----------------|--|-----------|
| Input Voltage: | 240V AC | |
| Wattage: | 7.5W/15W | 15W/30W |
| IP Rating: | IP65 | |
| Emergency: | Maintained/Non-Maintained | |
| LED Type: | SMD | |
| Battery: | LiFePO4 (Charge time 24hrs) | |
| CRI: | ≥80 | |
| Beam Angle (°) | 120° | |
| Cover: | Opal Diffuser with even light output | |
| Terminal: | Large Terminal, PA16 | |
| Inclusion: | S/Steel clips fitted with poly carb clips in the box as an option, pre-drilled side cable entry with rubber seal, Finger holes for easy removal of gear tray when installing, good quality polycarbonate material (not cheap recyclable material). | |
| Options: | ON/OFF and DIMMABLE Internal Sensor available. Remote control required for sensor adjustment. One remote control will operate unlimited sensors. Remote control sold separately. DALI and TRIAC options available. | |
| Warranty: | 5 Year Warranty / 3 Year Warranty on Battery | |
| Compliance: | Fully Compliant to AS/NZS2293.3 | |

| Item No. | Variants | | CCT | Non-Dim | ON/OFF Sensor | DIM Sensor | Lumen Output | | |
|--------------|----------|----------|------|---------|---------------|------------|------------------|---------------------|----------------|
| | EM | Standard | | | | | Warm White 3000K | Neutral White 4000K | White 5000K |
| HYDRO-60-EM | 66020 | 66012 | TRIO | ● | - | - | 950lm /1850lm | 980lm /1900lm | 950lm /1850lm |
| | 66030 | 66028 | | - | ● | - | | | |
| | 66031 | 66029 | | - | - | ● | | | |
| HYDRO-120-EM | 66021 | 66017 | | ● | - | - | 2350lm /4050lm | 2400lm /4250lm | 2400lm /4150lm |
| | 66022 | 66025 | | - | ● | - | | | |
| | 66023 | 66026 | | - | - | ● | | | |



Bolt Series

Bolt Series



| | Bolt-60 | Bolt-120 |
|-----------------|--|---------------------|
| Input Voltage: | 240V AC | |
| Wattage: | 10W/12W/15W/17W/20W | 20W/25W/30W/36W/40W |
| Emergency: | Sustained | |
| LED Type | SMD | |
| Battery: | LiFePO4 (Charge time 24hrs) | |
| CRI: | ≥80 | |
| Beam Angle (°) | 120° | |
| Lifespan: | 40,000hrs | |
| Installation: | Surface Mounted or Suspended | |
| Wide Body: | 130mm (BOLT-EM-60-TRIO Only) | |
| Rated Duration: | 120 min | |
| Classification: | C0: D50, C90: D32 | |
| Warranty: | 5 Year Warranty / 3 Year Warranty on Battery | |
| Compliance: | Fully Compliant to AS/NZS2293.3 | |

Emergency

Emergency



| Item No. | Variants | | CCT | Non-Dim | ON/OFF Sensor | DIM Sensor | Lumen Output | | |
|--------------------|--------------|--------------|------|---------|---------------|------------|------------------|---------------------|----------------|
| | EM | Standard | | | | | Warm White 3000K | Neutral White 4000K | White 5700K |
| BOLT-60-EM | 66007 | 66000 | TRIO | • | - | - | 900lm /1800lm | 1000lm /2000lm | 1000lm /2000lm |
| BOLT-120-EM | 66006 | 66003 | | • | - | - | 900lm /3600lm | 1000lm /400lm | 1000lm /4000lm |



SENSOR Surface Mounted



| | |
|----------------------|--------------------------------------|
| Input Voltage: | 240V AC |
| Power | 0.5W |
| Rated Load | 1000W LED |
| Detection Distance: | 2-20m (<24°C) |
| Installation Height: | 2.2 - 6m |
| Time Delay | Min 10sec ± 3sec / Max 30min ± 2min |
| Lux Adjustable: | Ambient Light <3-2000 |
| Working Temperature | -20°C~ +40°C |
| Size: | 102x102x58mm |
| Relay: | 16A |
| Features: | Manual override to bypass PIR sensor |
| Warranty: | 5 Year Warranty |
| Compliance: | Fully Compliant to AS/NZS2293.3 |

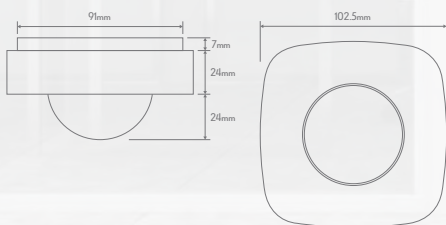

| Item No. | Variants | IP Rating | Range |
|--------------|----------|-----------|-------|
| SENSOR-SM-01 | 66033 | IP65 | 360° |



SENSOR Recessed Mounted



| | |
|----------------------|---|
| Input Voltage: | 240V AC |
| Power | 0.5W |
| Rated Load | 400W LED |
| Detection Distance: | Max 8m (<24°C) |
| Installation Height: | 2.2 - 4m |
| Time Delay | Min 10sec ± 3sec / Max 15min ± 3min |
| Lux Adjustable: | Ambient Light <10-2000 |
| Working Temperature | -20°C~ +40°C |
| Size: | 80x44mm |
| Cutout: | 70mm |
| Features: | 30°C tilt, manual override to bypass PIR sensor |
| Warranty: | 5 Year Warranty |
| Compliance: | Fully Compliant to AS/NZS2293.3 |

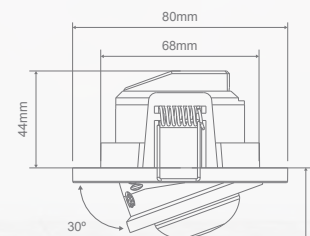

| Item No. | Variants | IP Rating | Range |
|---------------|----------|-----------|-------|
| SENSOR-REC-01 | 66036 | IP20 | 360° |



Clarifications

In this document, “we”, “us”, and “our” refers to Domus Lighting Pty Ltd.

“The customer” refers to the end user who purchases one of our products through an authorised distributor.

As an Australian supplier, all of our products are covered by the guarantees provided under Australian Consumer Law. Domus Lighting offers a private warranty that is additional to, not in lieu of, the pre-existing legal consumer rights of our customers.

Warranty Qualification

In order to be eligible for warranty claim:

1. The customer must have been the purchaser of our product and must be able to show their proof of purchase.
2. The product must have been installed by a licensed electrician.
3. The customer must be able to provide evidence of the fault.
4. The product must have been installed in accordance with our installation guidelines.

Warranty Coverage

Once a warranty claim has been submitted, we will assess the claim and determine the most appropriate resolution. Depending on circumstances, we may elect to send a member of our team to completely replace the faulty product / part or may defer to a third party to complete the replacement. In either case, our liability is limited to the cost of either repairing or replacing the faulty product. In the event that it is found that there is no fault with our product, or that the product is not from Domus Lighting, then a service charge may be incurred to the consumer to cover the cost of the call-out.

If the faulty product is no longer supplied by us, then Domus Lighting is obligated to replace the product with another suitable product from our range or provide a refund for the purchase, as deemed appropriate. Please note that the duration of the warranty runs from the original date of purchase and will not be extended if the original product is replaced.

Our standard warranty period will vary from item to item, and within each item will vary depending on whether the product application is residential or commercial. Please refer to the “Warranty Durations” table on this document to determine your product warranty duration.

We define “residential application” as being installed in a domestic environment such as a house or apartment, with usage not exceeding an average of 8 hours per 24-hour period.

We define “commercial application” as being installed in the address of a registered business or service, and or where the usage of our product exceeds an average of 8 hours per 24-hour period.

Date: 18/05/2023



Exceptions

Our warranty may be voided in the following circumstances:

- If the product has been damaged as a result of non-adherence to our product installation guidelines.
- If the product has been purchased through a non-approved seller.
- If proof of purchase cannot be produced.
- If the product is found to have been improperly stored or used.
- If the product has not been maintained as per any guidelines in the manual.
- If the product has been damaged due to misuse or wear and tear.
- If the product has been damaged due to incorrect voltage, or adverse external conditions such as power dips, lightning, extreme weather, exposure to heat, corrosion, or infestations of insects /vermin.
- If the product has been damaged due to it’s combined use with non-athourised products /globes.
- If the product has been repaired by a non-registered electrician.
- If the product is not a Domus Lighting product.
- If the product has not failed to the extent that it no longer performs to its published specifications and features.
- If the product has been installed in a location not appropriate for its given IP rating.
- If the product has corroded or rusted due to being installed within 5km of a saltwater environment.
- If the product has been installed in a location where it cannot be easily serviced, repaired, or replaced without causing further damage to the fitting or its surroundings.
- If the product has been in any way modified or tampered with to the extent that it differs from the original product.

Disclaimers

Domus Lighting reserves the right to, at its own sole discretion, to amend and or update the terms and conditions of this policy in the future without notice.



Warranty Statement

Warranty Durations

| Product Category | Residential Warranty | Commercial Warranty |
|--|--|--|
| Interior | | |
| Downlights (Purchased before 01/05/2023) | 3 Year Replacement | 2 Year Replacement |
| Downlights (Purchased from 01/05/2023) | 5 Year Replacement | 3 Year Replacement |
| LED: Strips, Globes, Oysters, Panels, Pendants, Wall Lights, Step Lights | 3 Year Replacement | 12 Month Replacement |
| LED Battens | 5 Year Replacement | 5 Year Replacement |
| Pendants, Table and Desk Lamps, Floor Lamps, Ceramic Lights, Hollywood Lights | 12 Month Replacement | 12 Month Replacement |
| Exterior | | |
| LED: Wall Lights, Spotlights, Steplights, Security Lights, Floodlights, Garden Lights, Deck Lights, Inground Lights, Bunker Lights | 3 Year Replacement | 12 Month Replacement |
| Bollard Lights, Traditional Exterior Lights, Polycarbonate Wall Lights, Acrylic Spheres | 12 Month Replacement | 12 Month Replacement |
| Power Supplies & Controllers | | |
| LED Power Supplies and Controllers | 3 Year Replacement | 12 Month Replacement |
| IP67 Power Supplies | 5 Year Replacement | 3 Year Replacement |
| Air Movement | | |
| Ceiling Fans, Exhaust Fans, and Bathroom Heaters | 6 Years Total: (3 Years In-Home, then 3 years Part Replacement) | |
| Emergency Lighting | | |
| Emergency Lighting | 5 Year Replacement, 4 Year Battery Replacement | 4 Year Replacement, 4 Year Battery Replacement |
| D40 Emergency Lights | 2 Year Replacement | |
| COB LED Strips | | |
| COB LED Strips | 3 Year Replacement, Total 5 year replacement when used with our drivers | 12 Month Replacement, Total 2 Year replacement when used with our drivers |

All other products not listed are covered by a 12 month replacement warranty.



DOMUS[®]

29-31 Richland Street, Kingsgrove. NSW 2208.

Ph: (02) 9554 9600 | domuslighting.com.au | enquiries@domuslighting.com.au