

HAVIT
Lighting

20
25

Lighting
By Havit



Tel: 02 9381 8300

Fax: 02 9666 8881

Email: sales@havit.com.au

web: www.havit.com.au

Address:

143 Beauchamp Road

Matrville NSW 2036

Australia

Postal:

PO Box 787

Matrville NSW 2036

Australia

All images and information in this publication are a guide to the displayed product and should be checked at **www.havit.com.au** prior to purchase. Information is subject to change without notification at the discretion of Havit Lighting.

For further information please contact the team at Havit Lighting.

Some fittings within the Havit Lighting catalogue are supplied with complimentary globes. Although Havit Lighting will make every effort to supply the globe shown, another globe may be supplied if models change or a globe is not available.

For information about our warranty visit:

www.havit.com.au/warranty



**Scan QR code to see Havit Lighting
Warranty Terms & Conditions**



Havit Lighting Catalogue 2025 Issue No. 23

www.Havit.com.au



@HavitLighting



@LightingbyHavit



@HavitLighting

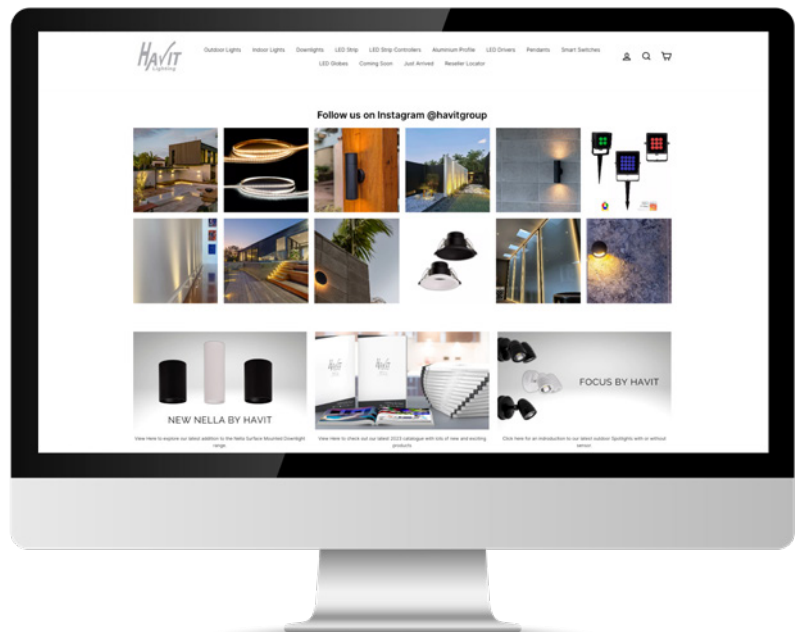
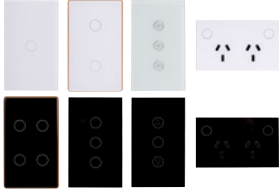

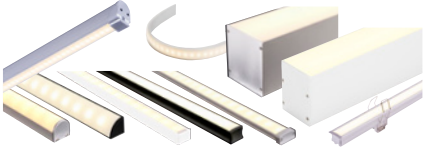







TABLE OF CONTENTS

<p>PREMIUM WALL LIGHTS</p>  <p>PAGES 1-18</p>	<p>PREMIUM WALL LIGHTS (CONTINUED)</p>  <p>PAGES 19-28</p>	<p>GARDEN LIGHTS</p>  <p>PAGES 29-58</p>
<p>POND LIGHTS</p>  <p>PAGE 59-60</p>	<p>OUTDOOR BOLLARDS</p>  <p>PAGES 61-76</p>	<p>IN-GROUND & STEP LIGHTS</p>  <p>PAGES 77-98</p>
<p>DECK LIGHTS</p>  <p>PAGES 99-102</p>	<p>IN-GROUND & STEP LIGHTS</p>  <p>PAGES 103-108</p>	<p>STEP LIGHTS & BRICK LIGHTS</p>  <p>PAGES 109-122</p>
<p>STEP LIGHTS</p>  <p>PAGES 123-156</p>	<p>WALL LIGHTS</p>  <p>PAGE 157-224</p>	<p>BAR LIGHTS</p>  <p>PAGES 225-230</p>
<p>RECESSED DOWNLIGHTS</p>  <p>PAGES 231-244</p>	<p>DOWNLIGHTS & PENDANTS</p>  <p>PAGES 245-260</p>	<p>OYSTERS & PENDANTS</p>  <p>PAGES 261-270</p>
<p>LINEAR PENDANTS</p>  <p>PAGES 271-274</p>	<p>INTERIOR WALL LIGHTS</p>  <p>PAGES 275-278</p>	<p>LED STRIP CONTROL EQUIPMENT</p>  <p>PAGES 279-290</p>

TABLE OF CONTENTS

WIFI SWITCHES	LED DRIVERS	LED PROFILE INDEX
		<p>LED Profile by Havit</p> <p>Quick Reference</p>
PAGES 291-294	PAGES 295-306	PAGES 307-308
LED ALUMINIUM PROFILE	LED STRIP	VIPER LED STRIP KITS
		
PAGES 309-365	PAGES 366-400	PAGES 401-404
LED & TRI-COLOUR GLOBES	CANOPIES	ACCESSORIES
		
PAGES 405-408	PAGES 409-410	PAGES 411-412
INFORMATION	WARRANTY & MAINTENANCE	NOTES & UPDATES
<p>IP & IK RATING CHART by Havit</p> <p>INGRESS PROTECTION GUIDE IK RATINGS EXPLAINED</p>	<p>Warranty Terms & Conditions Stainless Steel Maintenance Copper Care</p>	<p>Lighting by Havit</p>
PAGES 413-414	PAGES 415-418	PAGES 419-422

20
25
LIFESTYLE
LIGHTING



HV1005T
HV1007GU10T
HV1007MR16T

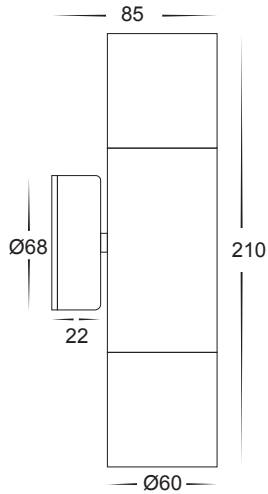

HV1105T
HV1107GU10T
HV1107MR16T

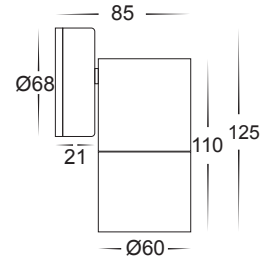

Tivah 316 Stainless Steel

- Stainless Steel 316 Marine Grade
- Includes a matching stainless steel backing plate
- High output reflector to maximise light
- IP Rating: IP65

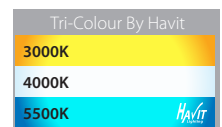

PART NUMBER	COLOUR TEMP	LUMENS	INPUT	INCLUDED LED
HV1005T	3000K - 4000K - 5500K	2x 240-560lm - 2x 255-595lm - 2x 270-630lm	240v	9 in 1 Tri-Colour 2x 3/5/7w GU10 LED
HV1007GU10T	3000K - 4000K - 5500K	2x 270lm - 2x 285lm - 2x 300lm	240v	Tri-Colour 2x 5w GU10 LED
HV1007MR16T	3000K - 4000K - 5500K	2x 270lm - 2x 285lm - 2x 300lm	12v DC	Tri-Colour 2x 5w MR16 LED
HV1105T	3000K - 4000K - 5500K	240-560lm - 255-595lm - 270-630lm	240v	9 in 1 Tri-Colour 3/5/7w GU10 LED
HV1107GU10T	3000K - 4000K - 5500K	270lm - 285lm - 300lm	240v	Tri-Colour 5w GU10 LED
HV1107MR16T	3000K - 4000K - 5500K	270lm - 285lm - 300lm	12v DC	Tri-Colour 5w MR16 LED
HAVIT COMPATIBLE ACCESSORIES				
HV9507	3000K - 4000K - 5500K	240lm-630lm	12v DC	Tri-Colour 3W/5W/7W MR16 LED
HV9508	3000K - 4000K - 5500K	240lm-630lm	24v DC	Tri-Colour 3W/5W/7W MR16 LED

See pages 295-306 for compatible drivers. All low voltage products that specify an input of 12v or 24v DC must be used with a suitable LED driver.



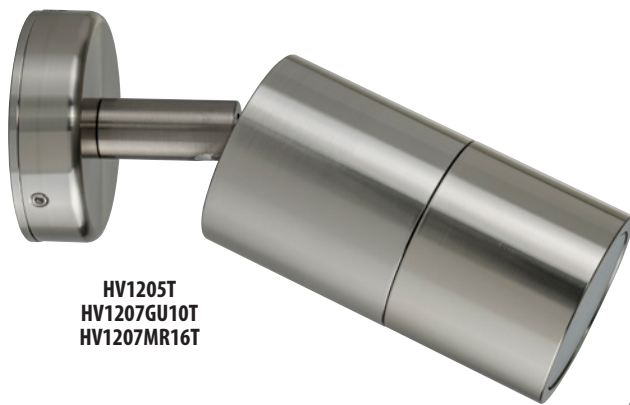

HV1205T
HV1207GU10T
HV1207MR16T

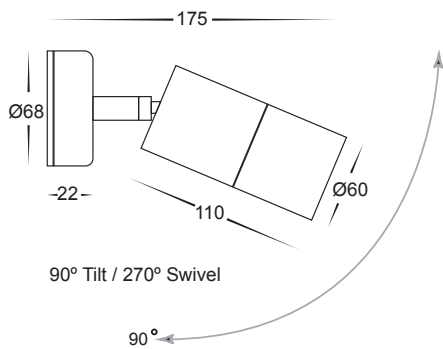

HV1305T
HV1307GU10T
HV1307MR16T

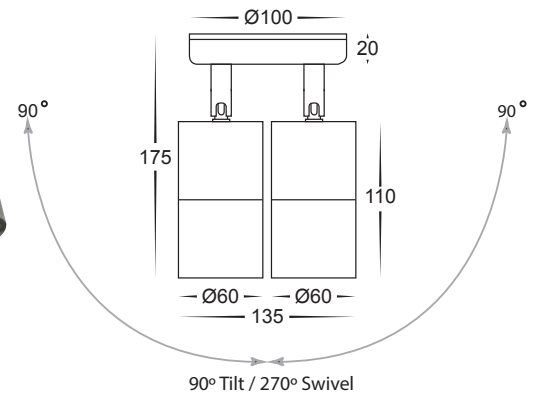

PART NUMBER	COLOUR TEMP	LUMENS	INPUT	INCLUDED LED
HV1205T	3000K - 4000K - 5500K	240-560lm - 255-595lm - 270-630lm	240v	9 in 1 Tri-Colour 3/5/7w GU10 LED
HV1207GU10T	3000K - 4000K - 5500K	270lm - 285lm - 300lm	240v	Tri-Colour 5w GU10 LED
HV1207MR16T	3000K - 4000K - 5500K	270lm - 285lm - 300lm	12v DC	Tri-Colour 5w MR16 LED
HV1305T	3000K - 4000K - 5500K	2x 240-560lm - 2x 255-595lm - 2x 270-630lm	240v	9 in 1 Tri-Colour 2x 3/5/7w GU10 LED
HV1307GU10T	3000K - 4000K - 5500K	2x 270lm - 2x 285lm - 2x 300lm	240v	Tri-Colour 2x 5w GU10 LED
HV1307MR16T	3000K - 4000K - 5500K	2x 270lm - 2x 285lm - 2x 300lm	12v DC	Tri-Colour 2x 5w MR16 LED
HAVIT COMPATIBLE ACCESSORIES				
HV9507	3000K - 4000K - 5500K	240lm-630lm	12v DC	Tri-Colour 3W/5W/7W MR16 LED
HV9508	3000K - 4000K - 5500K	240lm-630lm	24v DC	Tri-Colour 3W/5W/7W MR16 LED

See pages 295-306 for compatible drivers. All low voltage products that specify an input of 12v or 24v DC must be used with a suitable LED driver.



For detailed product specifications
visit www.Havit.com.au
or scan this QR code

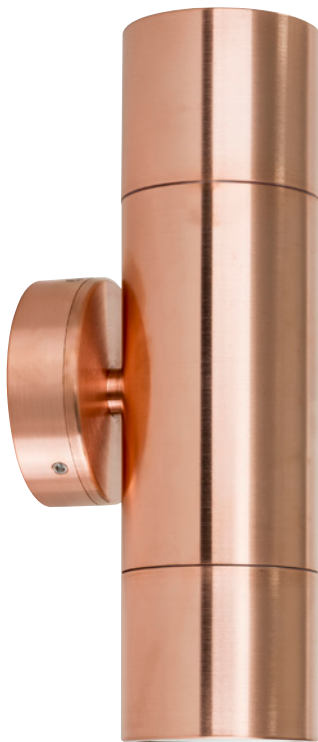

HV1015T
HV1017GU10T
HV1017MR16T

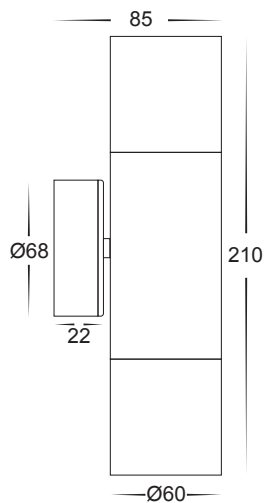

HV1115T
HV1117GU10T
HV1117MR16T

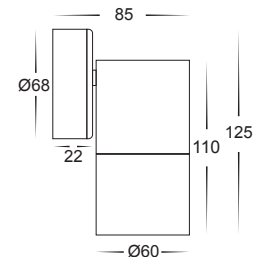

Tivah Solid Copper

- Solid Copper body
- Fast weathering for classic aged appearance
- Includes a matching backing plate
- High output reflector to maximise light
- IP Rating: IP65

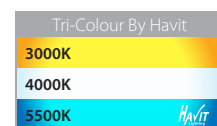

PART NUMBER	COLOUR TEMP	LUMENS	INPUT	INCLUDED LED
HV1015T	3000K - 4000K - 5500K	2x 240-560lm - 2x 255-595lm - 2x 270-630lm	240v	9 in 1 Tri-Colour 2x 3/5/7w GU10 LED
HV1017GU10T	3000K - 4000K - 5500K	2x 270lm - 2x 285lm - 2x 300lm	240v	Tri-Colour 2x 5w GU10 LED
HV1017MR16T	3000K - 4000K - 5500K	2x 270lm - 2x 285lm - 2x 300lm	12v DC	Tri-Colour 2x 5w MR16 LED
HV1115T	3000K - 4000K - 5500K	240-560lm - 255-595lm - 270-630lm	240v	9 in 1 Tri-Colour 3/5/7w GU10 LED
HV1117GU10T	3000K - 4000K - 5500K	270lm - 285lm - 300lm	240v	Tri-Colour 5w GU10 LED
HV1117MR16T	3000K - 4000K - 5500K	270lm - 285lm - 300lm	12v DC	Tri-Colour 5w MR16 LED
HAVIT COMPATIBLE ACCESSORIES				
HV9507	3000K - 4000K - 5500K	240lm-630lm	12v DC	Tri-Colour 3W/5W/7W MR16 LED
HV9508	3000K - 4000K - 5500K	240lm-630lm	24v DC	Tri-Colour 3W/5W/7W MR16 LED

See pages 295-306 for compatible drivers. All low voltage products that specify an input of 12v or 24v DC must be used with a suitable LED driver.



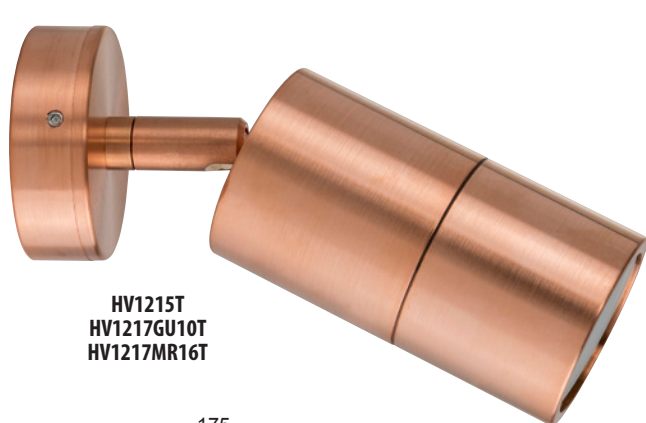

HV1215T
HV1217GU10T
HV1217MR16T

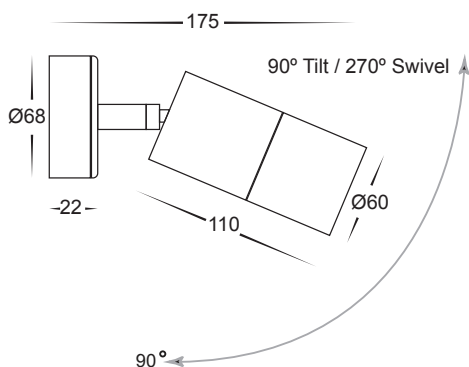

HV1315T
HV1317GU10T
HV1317MR16T

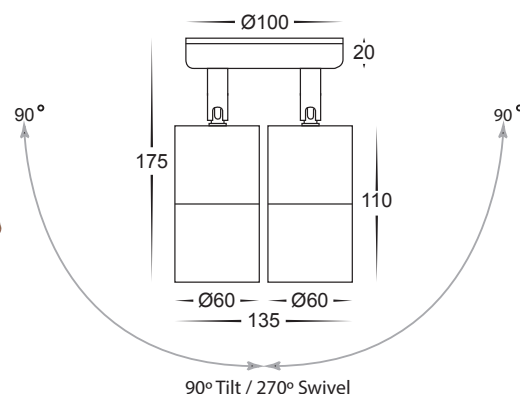

Weathered Copper

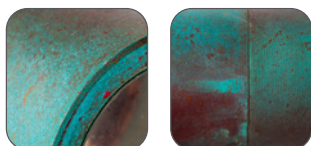

Solid Brass and Solid Copper fittings will naturally tarnish. Solid Brass fittings with additional coloured coatings (Antique Brass & Graphite) may tarnish through the coating when installed in outdoor environments.

PART NUMBER	COLOUR TEMP	LUMENS	INPUT	INCLUDED LED
HV1215T	3000K - 4000K - 5500K	240-560lm - 255-595lm - 270-630lm	240v	9 in 1 Tri-Colour 3/5/7w GU10 LED
HV1217GU10T	3000K - 4000K - 5500K	270lm - 285lm - 300lm	240v	Tri-Colour 5w GU10 LED
HV1217MR16T	3000K - 4000K - 5500K	270lm - 285lm - 300lm	12v DC	Tri-Colour 5w MR16 LED
HV1315T	3000K - 4000K - 5500K	2x 240-560lm - 2x 255-595lm - 2x 270-630lm	240v	9 in 1 Tri-Colour 2x 3/5/7w GU10 LED
HV1317GU10T	3000K - 4000K - 5500K	2x 270lm - 2x 285lm - 2x 300lm	240v	Tri-Colour 2x 5w GU10 LED
HV1317MR16T	3000K - 4000K - 5500K	2x 270lm - 2x 285lm - 2x 300lm	12v DC	Tri-Colour 2x 5w MR16 LED
HAVIT COMPATIBLE ACCESSORIES				
HV9507	3000K - 4000K - 5500K	240lm-630lm	12v DC	Tri-Colour 3W/5W/7W MR16 LED
HV9508	3000K - 4000K - 5500K	240lm-630lm	24v DC	Tri-Colour 3W/5W/7W MR16 LED

See pages 295-306 for compatible drivers. All low voltage products that specify an input of 12v or 24v DC must be used with a suitable LED driver.



For detailed product specifications
visit www.Havit.com.au
or scan this QR code



HV1025T
HV1027GU10T
HV1027MR16T

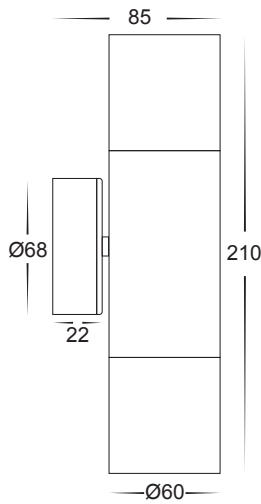

HV1125T
HV1127GU10T
HV1127MR16T

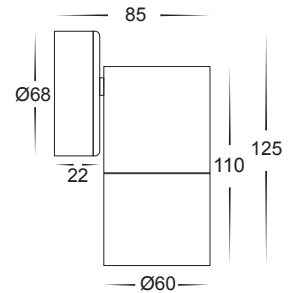

Tivah Aluminium Black

- Aluminium Poly Powder Coated Black
- Includes a matching aluminium backing plate
- High output reflector to maximise light
- IP Rating: IP65

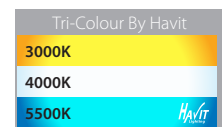

PART NUMBER	COLOUR TEMP	LUMENS	INPUT	INCLUDED LED
HV1025T	3000K - 4000K - 5500K	2x 240-560lm - 2x 255-595lm - 2x 270-630lm	240v	9 in 1 Tri-Colour 2x 3/5/7w GU10 LED
HV1027GU10T	3000K - 4000K - 5500K	2x 270lm - 2x 285lm - 2x 300lm	240v	Tri-Colour 2x 5w GU10 LED
HV1027MR16T	3000K - 4000K - 5500K	2x 270lm - 2x 285lm - 2x 300lm	12v DC	Tri-Colour 2x 5w MR16 LED
HV1125T	3000K - 4000K - 5500K	240-560lm - 255-595lm - 270-630lm	240v	9 in 1 Tri-Colour 3/5/7w GU10 LED
HV1127GU10T	3000K - 4000K - 5500K	270lm - 285lm - 300lm	240v	Tri-Colour 5w GU10 LED
HV1127MR16T	3000K - 4000K - 5500K	270lm - 285lm - 300lm	12v DC	Tri-Colour 5w MR16 LED
HAVIT COMPATIBLE ACCESSORIES				
HV9507	3000K - 4000K - 5500K	240lm-630lm	12v DC	Tri-Colour 3W/5W/7W MR16 LED
HV9508	3000K - 4000K - 5500K	240lm-630lm	24v DC	Tri-Colour 3W/5W/7W MR16 LED

See pages 295-306 for compatible drivers. All low voltage products that specify an input of 12v or 24v DC must be used with a suitable LED driver.





**HV1225T
HV1227GU10T
HV1227MR16T**

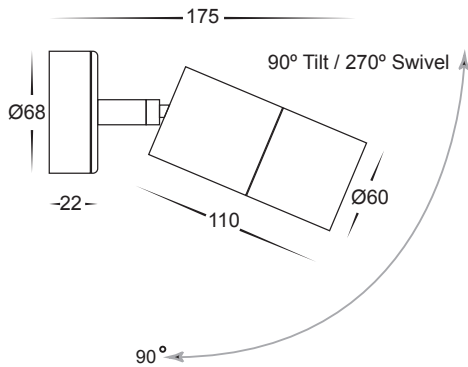

**HV1325T
HV1327GU10T
HV1327MR16T**

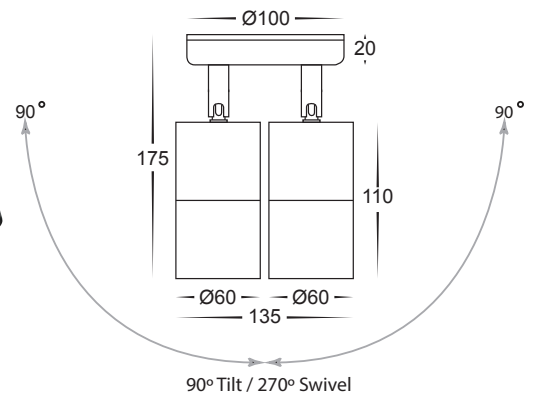

PART NUMBER	COLOUR TEMP	LUMENS	INPUT	INCLUDED LED
HV1225T	3000K - 4000K - 5500K	240-560lm - 255-595lm - 270-630lm	240v	9 in 1 Tri-Colour 3/5/7w GU10 LED
HV1227GU10T	3000K - 4000K - 5500K	270lm - 285lm - 300lm	240v	Tri-Colour 5w GU10 LED
HV1227MR16T	3000K - 4000K - 5500K	270lm - 285lm - 300lm	12v DC	Tri-Colour 5w MR16 LED
HV1325T	3000K - 4000K - 5500K	2x 240-560lm - 2x 255-595lm - 2x 270-630lm	240v	9 in 1 Tri-Colour 2x 3/5/7w GU10 LED
HV1327GU10T	3000K - 4000K - 5500K	2x 270lm - 2x 285lm - 2x 300lm	240v	Tri-Colour 2x 5w GU10 LED
HV1327MR16T	3000K - 4000K - 5500K	2x 270lm - 2x 285lm - 2x 300lm	12v DC	Tri-Colour 2x 5w MR16 LED
HAVIT COMPATIBLE ACCESSORIES				
HV9507	3000K - 4000K - 5500K	240lm-630lm	12v DC	Tri-Colour 3W/5W/7W MR16 LED
HV9508	3000K - 4000K - 5500K	240lm-630lm	24v DC	Tri-Colour 3W/5W/7W MR16 LED

See pages 295-306 for compatible drivers. All low voltage products that specify an input of 12v or 24v DC must be used with a suitable LED driver.



For detailed product specifications
visit www.Havit.com.au
or scan this QR code



HV1035T
HV1037GU10T
HV1037MR16T

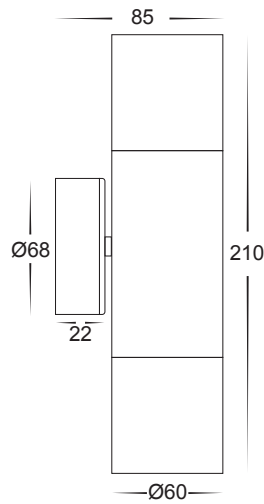

HV1135T
HV1137GU10T
HV1137MR16T

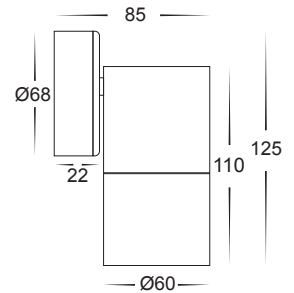

Tivah Aluminium White

- Aluminium Poly Powder Coated White
- Includes a matching aluminium backing plate
- High output reflector to maximise light
- IP Rating: IP65

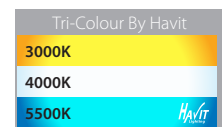

PART NUMBER	COLOUR TEMP	LUMENS	INPUT	INCLUDED LED
HV1035T	3000K - 4000K - 5500K	2x 240-560lm - 2x 255-595lm - 2x 270-630lm	240v	9 in 1 Tri-Colour 2x 3/5/7w GU10 LED
HV1037GU10T	3000K - 4000K - 5500K	2x 270lm - 2x 285lm - 2x 300lm	240v	Tri-Colour 2x 5w GU10 LED
HV1037MR16T	3000K - 4000K - 5500K	2x 270lm - 2x 285lm - 2x 300lm	12v DC	Tri-Colour 2x 5w MR16 LED
HV1135T	3000K - 4000K - 5500K	240-560lm - 255-595lm - 270-630lm	240v	9 in 1 Tri-Colour 3/5/7w GU10 LED
HV1137GU10T	3000K - 4000K - 5500K	270lm - 285lm - 300lm	240v	Tri-Colour 5w GU10 LED
HV1137MR16T	3000K - 4000K - 5500K	270lm - 285lm - 300lm	12v DC	Tri-Colour 5w MR16 LED
HAVIT COMPATIBLE ACCESSORIES				
HV9507	3000K - 4000K - 5500K	240lm-630lm	12v DC	Tri-Colour 3W/5W/7W MR16 LED
HV9508	3000K - 4000K - 5500K	240lm-630lm	24v DC	Tri-Colour 3W/5W/7W MR16 LED

See pages 295-306 for compatible drivers. All low voltage products that specify an input of 12v or 24v DC must be used with a suitable LED driver.



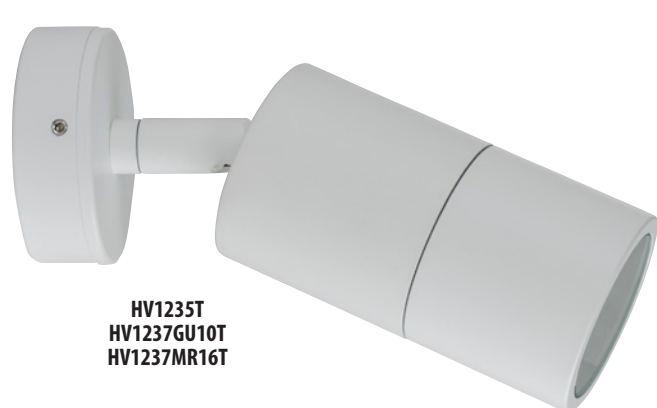

HV1235T
HV1237GU10T
HV1237MR16T

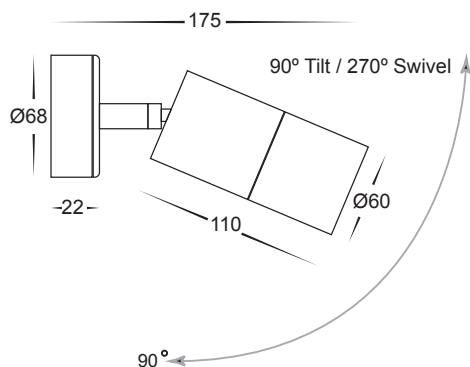

HV1335T
HV1337GU10T
HV1337MR16T

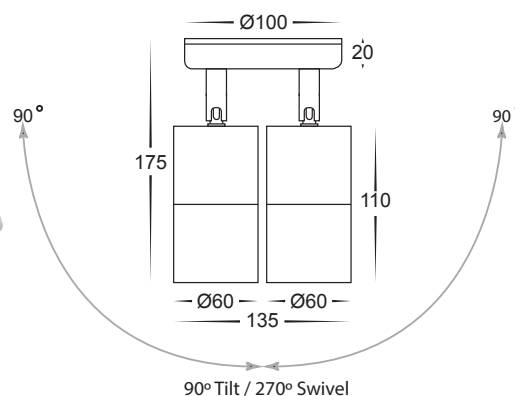

PART NUMBER	COLOUR TEMP	LUMENS	INPUT	INCLUDED LED
HV1235T	3000K - 4000K - 5500K	240-560lm - 255-595lm - 270-630lm	240v	9 in 1 Tri-Colour 3/5/7w GU10 LED
HV1237GU10T	3000K - 4000K - 5500K	270lm - 285lm - 300lm	240v	Tri-Colour 5w GU10 LED
HV1237MR16T	3000K - 4000K - 5500K	270lm - 285lm - 300lm	12v DC	Tri-Colour 5w MR16 LED
HV1335T	3000K - 4000K - 5500K	2x 240-560lm - 2x 255-595lm - 2x 270-630lm	240v	9 in 1 Tri-Colour 2x 3/5/7w GU10 LED
HV1337GU10T	3000K - 4000K - 5500K	2x 270lm - 2x 285lm - 2x 300lm	240v	Tri-Colour 2x 5w GU10 LED
HV1337MR16T	3000K - 4000K - 5500K	2x 270lm - 2x 285lm - 2x 300lm	12v DC	Tri-Colour 2x 5w MR16 LED
HAVIT COMPATIBLE ACCESSORIES				
HV9507	3000K - 4000K - 5500K	240lm-630lm	12v DC	Tri-Colour 3W/5W/7W MR16 LED
HV9508	3000K - 4000K - 5500K	240lm-630lm	24v DC	Tri-Colour 3W/5W/7W MR16 LED

See pages 295-306 for compatible drivers. All low voltage products that specify an input of 12v or 24v DC must be used with a suitable LED driver.



For detailed product specifications
visit www.Havit.com.au
or scan this QR code



HV1045T
HV1047GU10T
HV1047MR16T

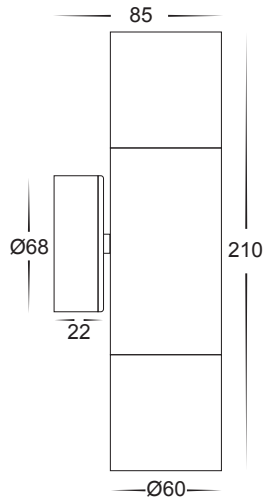

HV1145T
HV1147GU10T
HV1147MR16T

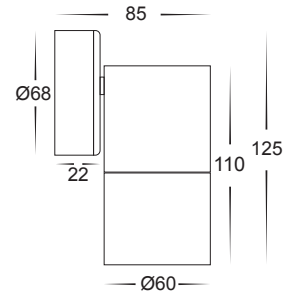

Tivah Aluminium Silver

- Aluminium Poly Powder Coated Silver
- Includes a matching aluminium backing plate
- High output reflector to maximise light
- IP Rating: IP65

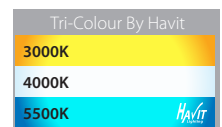

PART NUMBER	COLOUR TEMP	LUMENS	INPUT	INCLUDED LED
HV1045T	3000K - 4000K - 5500K	2x 240-560lm - 2x 255-595lm - 2x 270-630lm	240v	9 in 1 Tri-Colour 2x 3/5/7w GU10 LED
HV1047GU10T	3000K - 4000K - 5500K	2x 270lm - 2x 285lm - 2x 300lm	240v	Tri-Colour 2x 5w GU10 LED
HV1047MR16T	3000K - 4000K - 5500K	2x 270lm - 2x 285lm - 2x 300lm	12v DC	Tri-Colour 2x 5w MR16 LED
HV1145T	3000K - 4000K - 5500K	240-560lm - 255-595lm - 270-630lm	240v	9 in 1 Tri-Colour 3/5/7w GU10 LED
HV1147GU10T	3000K - 4000K - 5500K	270lm - 285lm - 300lm	240v	Tri-Colour 5w GU10 LED
HV1147MR16T	3000K - 4000K - 5500K	270lm - 285lm - 300lm	12v DC	Tri-Colour 5w MR16 LED
HAVIT COMPATIBLE ACCESSORIES				
HV9507	3000K - 4000K - 5500K	240lm-630lm	12v DC	Tri-Colour 3W/5W/7W MR16 LED
HV9508	3000K - 4000K - 5500K	240lm-630lm	24v DC	Tri-Colour 3W/5W/7W MR16 LED

See pages 295-306 for compatible drivers. All low voltage products that specify an input of 12v or 24v DC must be used with a suitable LED driver.



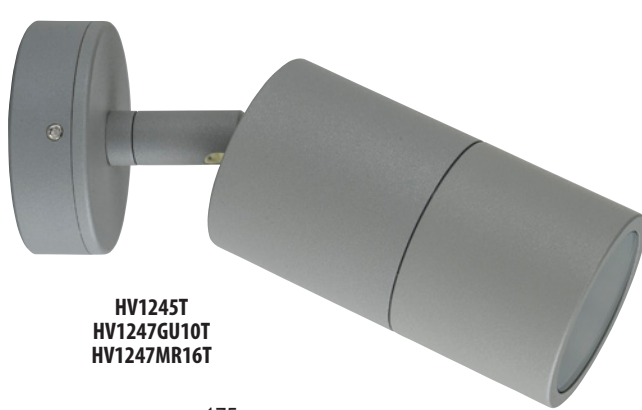

HV1245T
HV1247GU10T
HV1247MR16T

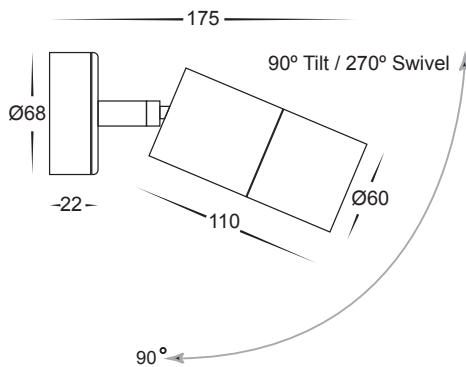

HV1345T
HV1347GU10T
HV1347MR16T

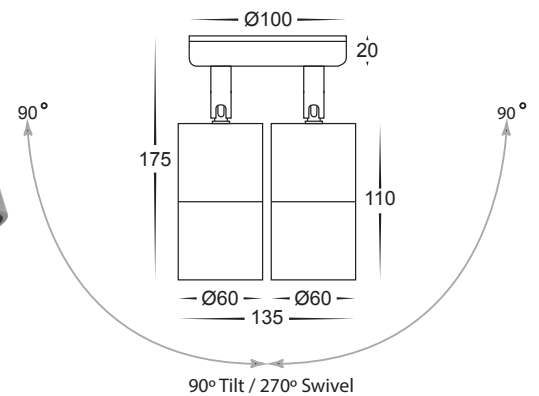

PART NUMBER	COLOUR TEMP	LUMENS	INPUT	INCLUDED LED
HV1245T	3000K - 4000K - 5500K	240-560lm - 255-595lm - 270-630lm	240v	9 in 1 Tri-Colour 3/5/7w GU10 LED
HV1247GU10T	3000K - 4000K - 5500K	270lm - 285lm - 300lm	240v	Tri-Colour 5w GU10 LED
HV1247MR16T	3000K - 4000K - 5500K	270lm - 285lm - 300lm	12v DC	Tri-Colour 5w MR16 LED
HV1345T	3000K - 4000K - 5500K	2x 240-560lm - 2x 255-595lm - 2x 270-630lm	240v	9 in 1 Tri-Colour 2x 3/5/7w GU10 LED
HV1347GU10T	3000K - 4000K - 5500K	2x 270lm - 2x 285lm - 2x 300lm	240v	Tri-Colour 2x 5w GU10 LED
HV1347MR16T	3000K - 4000K - 5500K	2x 270lm - 2x 285lm - 2x 300lm	12v DC	Tri-Colour 2x 5w MR16 LED
HAVIT COMPATIBLE ACCESSORIES				
HV9507	3000K - 4000K - 5500K	240lm-630lm	12v DC	Tri-Colour 3W/5W/7W MR16 LED
HV9508	3000K - 4000K - 5500K	240lm-630lm	24v DC	Tri-Colour 3W/5W/7W MR16 LED

See pages 295-306 for compatible drivers. All low voltage products that specify an input of 12v or 24v DC must be used with a suitable LED driver.



For detailed product specifications
visit www.Havit.com.au
or scan this QR code



HV1055T
HV1057GU10T
HV1057MR16T

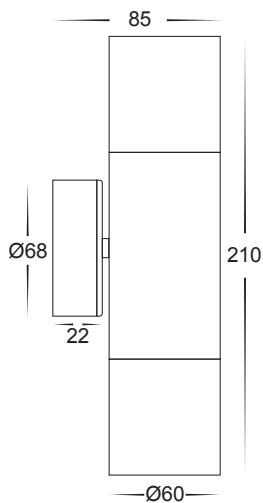

HV1155T
HV1157GU10T
HV1157MR16T

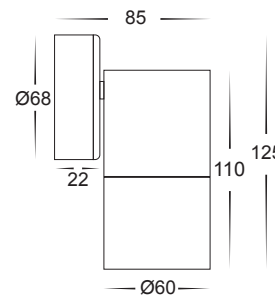

Tivah Solid Brass

- Solid Brass
- Includes a matching brass backing plate
- High output reflector to maximise light
- IP Rating: IP65

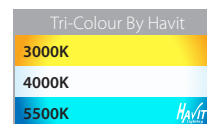

PART NUMBER	COLOUR TEMP	LUMENS	INPUT	INCLUDED LED
HV1055T	3000K - 4000K - 5500K	2x 240-560lm - 2x 255-595lm - 2x 270-630lm	240v	9 in 1 Tri-Colour 2x 3/5/7w GU10 LED
HV1057GU10T	3000K - 4000K - 5500K	2x 270lm - 2x 285lm - 2x 300lm	240v	Tri-Colour 2x 5w GU10 LED
HV1057MR16T	3000K - 4000K - 5500K	2x 270lm - 2x 285lm - 2x 300lm	12v DC	Tri-Colour 2x 5w MR16 LED
HV1155T	3000K - 4000K - 5500K	240-560lm - 255-595lm - 270-630lm	240v	9 in 1 Tri-Colour 3/5/7w GU10 LED
HV1157GU10T	3000K - 4000K - 5500K	270lm - 285lm - 300lm	240v	Tri-Colour 5w GU10 LED
HV1157MR16T	3000K - 4000K - 5500K	270lm - 285lm - 300lm	12v DC	Tri-Colour 5w MR16 LED
HAVIT COMPATIBLE ACCESSORIES				
HV9507	3000K - 4000K - 5500K	240lm-630lm	12v DC	Tri-Colour 3W/5W/7W MR16 LED
HV9508	3000K - 4000K - 5500K	240lm-630lm	24v DC	Tri-Colour 3W/5W/7W MR16 LED

See pages 295-306 for compatible drivers. All low voltage products that specify an input of 12v or 24v DC must be used with a suitable LED driver.





HV1255T
HV1257GU10T
HV1257MR16T

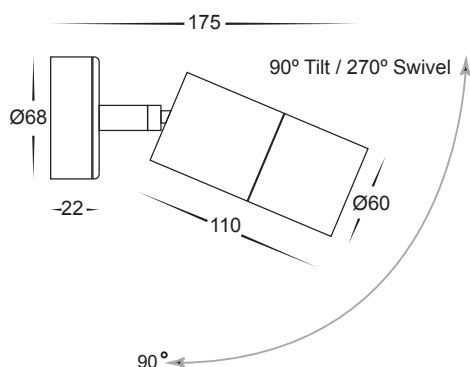

HV1355T
HV1357GU10T
HV1357MR16T

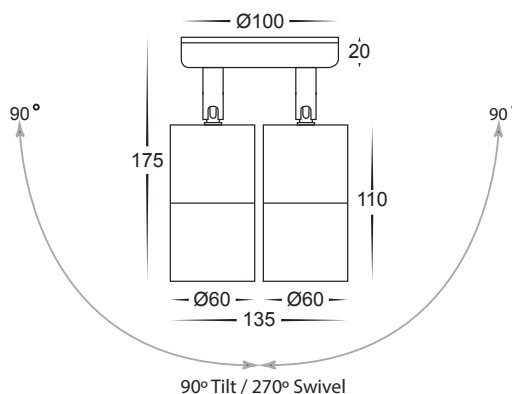

Solid Brass fittings will naturally tarnish. Solid Brass fittings with additional coloured coatings (Antique Brass & Graphite) may tarnish through the coating when installed in outdoor environments.

PART NUMBER	COLOUR TEMP	LUMENS	INPUT	INCLUDED LED
HV1255T	3000K - 4000K - 5500K	240-560lm - 255-595lm - 270-630lm	240v	9 in 1 Tri-Colour 3/5/7w GU10 LED
HV1257GU10T	3000K - 4000K - 5500K	270lm - 285lm - 300lm	240v	Tri-Colour 5w GU10 LED
HV1257MR16T	3000K - 4000K - 5500K	270lm - 285lm - 300lm	12v DC	Tri-Colour 5w MR16 LED
HV1355T	3000K - 4000K - 5500K	2x 240-560lm - 2x 255-595lm - 2x 270-630lm	240v	9 in 1 Tri-Colour 2x 3/5/7w GU10 LED
HV1357GU10T	3000K - 4000K - 5500K	2x 270lm - 2x 285lm - 2x 300lm	240v	Tri-Colour 2x 5w GU10 LED
HV1357MR16T	3000K - 4000K - 5500K	2x 270lm - 2x 285lm - 2x 300lm	12v DC	Tri-Colour 2x 5w MR16 LED
HAVIT COMPATIBLE ACCESSORIES				
HV9507	3000K - 4000K - 5500K	240lm-630lm	12v DC	Tri-Colour 3W/5W/7W MR16 LED
HV9508	3000K - 4000K - 5500K	240lm-630lm	24v DC	Tri-Colour 3W/5W/7W MR16 LED

See pages 295-306 for compatible drivers. All low voltage products that specify an input of 12v or 24v DC must be used with a suitable LED driver.



For detailed product specifications visit www.Havit.com.au or scan this QR code



HV1075T
HV1077GU10T
HV1077MR16T

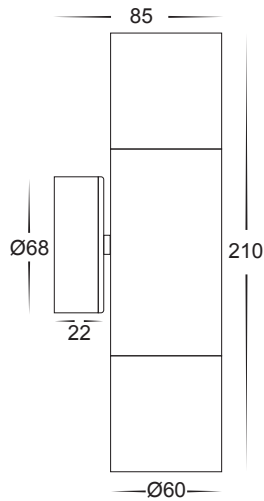

HV1175T
HV1177GU10T
HV1177MR16T

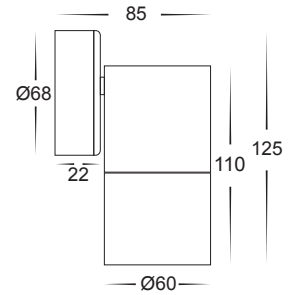

Tivah Solid Brass Graphite

- Graphite Coloured Solid Brass
- Includes a matching brass backing plate
- High output reflector to maximise light
- IP Rating: IP65

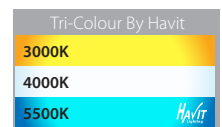

PART NUMBER	COLOUR TEMP	LUMENS	INPUT	INCLUDED LED
HV1075T	3000K - 4000K - 5500K	2x 240-560lm - 2x 255-595lm - 2x 270-630lm	240v	9 in 1 Tri-Colour 2x 3/5/7w GU10 LED
HV1077GU10T	3000K - 4000K - 5500K	2x 270lm - 2x 285lm - 2x 300lm	240v	Tri-Colour 2x 5w GU10 LED
HV1077MR16T	3000K - 4000K - 5500K	2x 270lm - 2x 285lm - 2x 300lm	12v DC	Tri-Colour 2x 5w MR16 LED
HV1175T	3000K - 4000K - 5500K	240-560lm - 255-595lm - 270-630lm	240v	9 in 1 Tri-Colour 3/5/7w GU10 LED
HV1177GU10T	3000K - 4000K - 5500K	270lm - 285lm - 300lm	240v	Tri-Colour 5w GU10 LED
HV1177MR16T	3000K - 4000K - 5500K	270lm - 285lm - 300lm	12v DC	Tri-Colour 5w MR16 LED
HAVIT COMPATIBLE ACCESSORIES				
HV9507	3000K - 4000K - 5500K	240lm-630lm	12v DC	Tri-Colour 3W/5W/7W MR16 LED
HV9508	3000K - 4000K - 5500K	240lm-630lm	24v DC	Tri-Colour 3W/5W/7W MR16 LED

See pages 295-306 for compatible drivers. All low voltage products that specify an input of 12v or 24v DC must be used with a suitable LED driver.





HV1275T
HV1277GU10T
HV1277MR16T

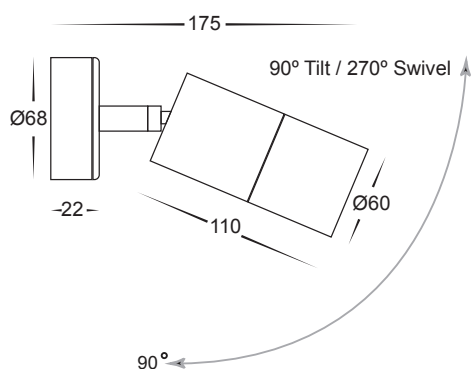

HV1375T
HV1377GU10T
HV1377MR16T

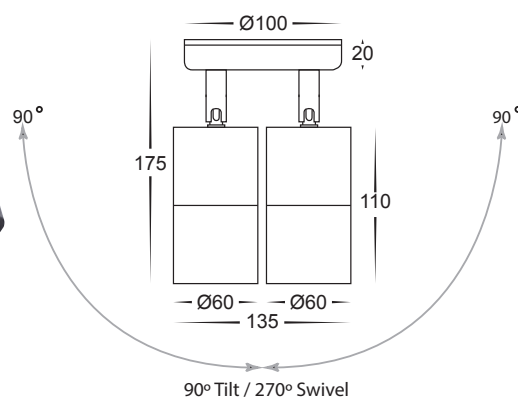

Solid Brass fittings will naturally tarnish. Solid Brass fittings with additional coloured coatings (Antique Brass & Graphite) may tarnish through the coating when installed in outdoor environments.

PART NUMBER	COLOUR TEMP	LUMENS	INPUT	INCLUDED LED
HV1275T	3000K - 4000K - 5500K	240-560lm - 255-595lm - 270-630lm	240v	9 in 1 Tri-Colour 3/5/7w GU10 LED
HV1277GU10T	3000K - 4000K - 5500K	270lm - 285lm - 300lm	240v	Tri-Colour 5w GU10 LED
HV1277MR16T	3000K - 4000K - 5500K	270lm - 285lm - 300lm	12v DC	Tri-Colour 5w MR16 LED
HV1375T	3000K - 4000K - 5500K	2x 240-560lm - 2x 255-595lm - 2x 270-630lm	240v	9 in 1 Tri-Colour 2x 3/5/7w GU10 LED
HV1377GU10T	3000K - 4000K - 5500K	2x 270lm - 2x 285lm - 2x 300lm	240v	Tri-Colour 2x 5w GU10 LED
HV1377MR16T	3000K - 4000K - 5500K	2x 270lm - 2x 285lm - 2x 300lm	12v DC	Tri-Colour 2x 5w MR16 LED
HAVIT COMPATIBLE ACCESSORIES				
HV9507	3000K - 4000K - 5500K	240lm-630lm	12v DC	Tri-Colour 3W/5W/7W MR16 LED
HV9508	3000K - 4000K - 5500K	240lm-630lm	24v DC	Tri-Colour 3W/5W/7W MR16 LED

See pages 295-306 for compatible drivers. All low voltage products that specify an input of 12v or 24v DC must be used with a suitable LED driver.



For detailed product specifications visit www.Havit.com.au or scan this QR code



HV1085T
HV1087GU10T
HV1087MR16T

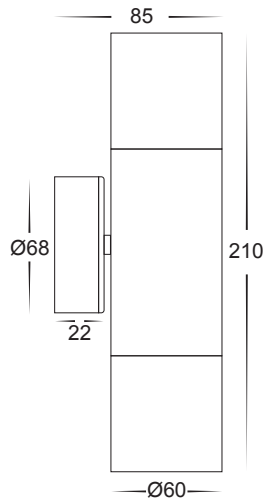

HV1185T
HV1187GU10T
HV1187MR16T

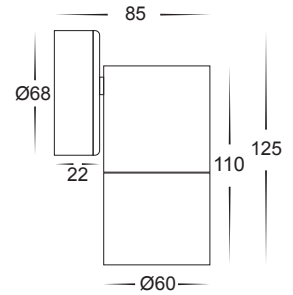

Tivah Aluminium Titanium

- Titanium Coloured Aluminium
- Includes a matching aluminium backing plate
- High output reflector to maximise light
- IP Rating: IP65

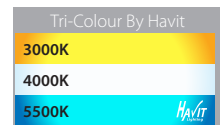

PART NUMBER	COLOUR TEMP	LUMENS	INPUT	INCLUDED LED
HV1085T	3000K - 4000K - 5500K	2x 240-560lm - 2x 255-595lm - 2x 270-630lm	240v	9 in 1 Tri-Colour 2x 3/5/7w GU10 LED
HV1087GU10T	3000K - 4000K - 5500K	2x 270lm - 2x 285lm - 2x 300lm	240v	Tri-Colour 2x 5w GU10 LED
HV1087MR16T	3000K - 4000K - 5500K	2x 270lm - 2x 285lm - 2x 300lm	12v DC	Tri-Colour 2x 5w MR16 LED
HV1185T	3000K - 4000K - 5500K	240-560lm - 255-595lm - 270-630lm	240v	9 in 1 Tri-Colour 3/5/7w GU10 LED
HV1187GU10T	3000K - 4000K - 5500K	270lm - 285lm - 300lm	240v	Tri-Colour 5w GU10 LED
HV1187MR16T	3000K - 4000K - 5500K	270lm - 285lm - 300lm	12v DC	Tri-Colour 5w MR16 LED
HAVIT COMPATIBLE ACCESSORIES				
HV9507	3000K - 4000K - 5500K	240lm-630lm	12v DC	Tri-Colour 3W/5W/7W MR16 LED
HV9508	3000K - 4000K - 5500K	240lm-630lm	24v DC	Tri-Colour 3W/5W/7W MR16 LED

See pages 295-306 for compatible drivers. All low voltage products that specify an input of 12v or 24v DC must be used with a suitable LED driver.



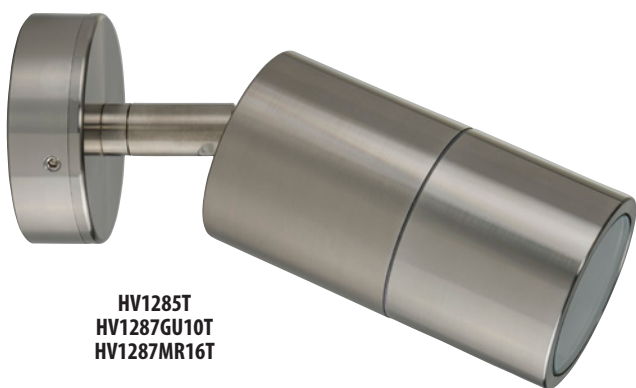

**HV1285T
HV1287GU10T
HV1287MR16T**

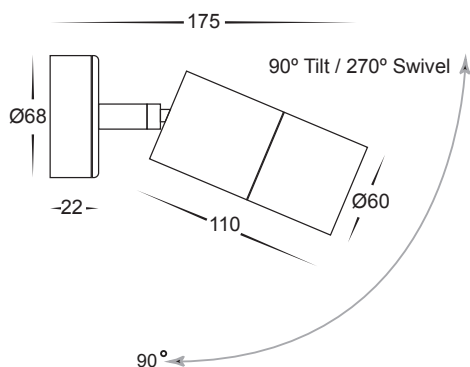

**HV1385T
HV1387GU10T
HV1387MR16T**

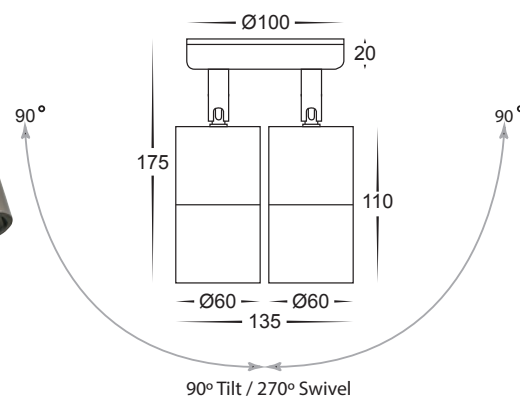

PART NUMBER	COLOUR TEMP	LUMENS	INPUT	INCLUDED LED
HV1285T	3000K - 4000K - 5500K	240-560lm - 255-595lm - 270-630lm	240v	9 in 1 Tri-Colour 3/5/7w GU10 LED
HV1287GU10T	3000K - 4000K - 5500K	270lm - 285lm - 300lm	240v	Tri-Colour 5w GU10 LED
HV1287MR16T	3000K - 4000K - 5500K	270lm - 285lm - 300lm	12v DC	Tri-Colour 5w MR16 LED
HV1385T	3000K - 4000K - 5500K	2x 240-560lm - 2x 255-595lm - 2x 270-630lm	240v	9 in 1 Tri-Colour 2x 3/5/7w GU10 LED
HV1387GU10T	3000K - 4000K - 5500K	2x 270lm - 2x 285lm - 2x 300lm	240v	Tri-Colour 2x 5w GU10 LED
HV1387MR16T	3000K - 4000K - 5500K	2x 270lm - 2x 285lm - 2x 300lm	12v DC	Tri-Colour 2x 5w MR16 LED
HAVIT COMPATIBLE ACCESSORIES				
HV9507	3000K - 4000K - 5500K	240lm-630lm	12v DC	Tri-Colour 3W/5W/7W MR16 LED
HV9508	3000K - 4000K - 5500K	240lm-630lm	24v DC	Tri-Colour 3W/5W/7W MR16 LED

See pages 295-306 for compatible drivers. All low voltage products that specify an input of 12v or 24v DC must be used with a suitable LED driver.



For detailed product specifications
visit www.Havit.com.au
or scan this QR code



HV1095T
HV1097GU10T
HV1097MR16T

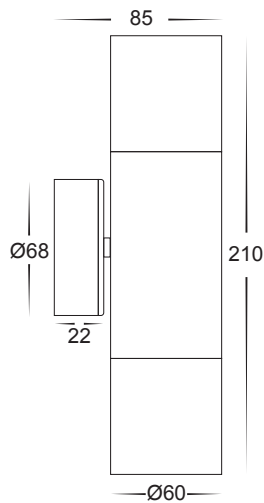

HV1195T
HV1197GU10T
HV1197MR16T

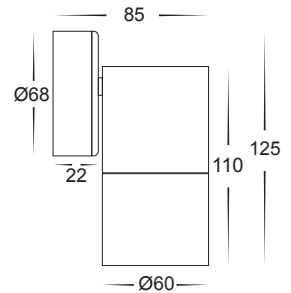

Tivah Antique Brass

- Solid Brass With Antique Brass Finish
- Includes a matching brass backing plate
- High output reflector to maximise light
- IP Rating: IP65

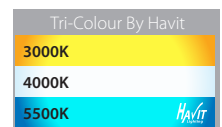

PART NUMBER	COLOUR TEMP	LUMENS	INPUT	INCLUDED LED
HV1095T	3000K - 4000K - 5500K	2x 240-560lm - 2x 255-595lm - 2x 270-630lm	240v	9 in 1 Tri-Colour 2x 3/5/7w GU10 LED
HV1097GU10T	3000K - 4000K - 5500K	2x 270lm - 2x 285lm - 2x 300lm	240v	Tri-Colour 2x 5w GU10 LED
HV1097MR16T	3000K - 4000K - 5500K	2x 270lm - 2x 285lm - 2x 300lm	12v DC	Tri-Colour 2x 5w MR16 LED
HV1195T	3000K - 4000K - 5500K	240-560lm - 255-595lm - 270-630lm	240v	9 in 1 Tri-Colour 3/5/7w GU10 LED
HV1197GU10T	3000K - 4000K - 5500K	270lm - 285lm - 300lm	240v	Tri-Colour 5w GU10 LED
HV1197MR16T	3000K - 4000K - 5500K	270lm - 285lm - 300lm	12v DC	Tri-Colour 5w MR16 LED
HAVIT COMPATIBLE ACCESSORIES				
HV9507	3000K - 4000K - 5500K	240lm-630lm	12v DC	Tri-Colour 3W/5W/7W MR16 LED
HV9508	3000K - 4000K - 5500K	240lm-630lm	24v DC	Tri-Colour 3W/5W/7W MR16 LED

See pages 295-306 for compatible drivers. All low voltage products that specify an input of 12v or 24v DC must be used with a suitable LED driver.



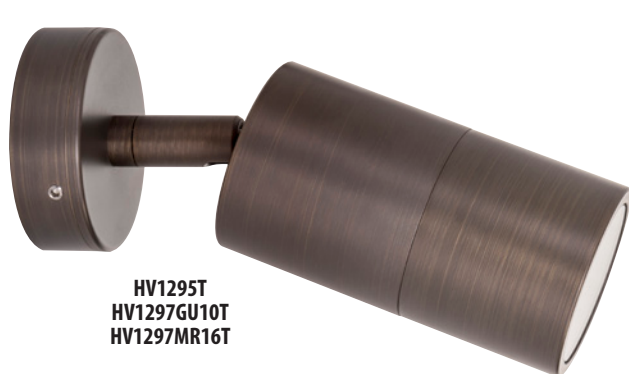

HV1295T
HV1297GU10T
HV1297MR16T

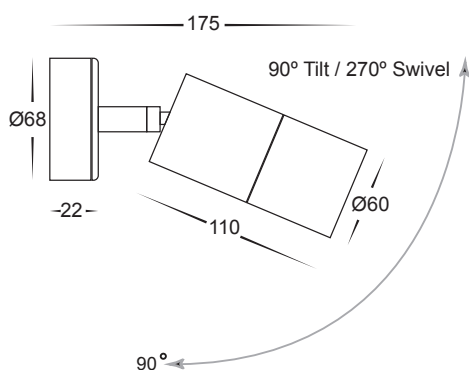

HV1395T
HV1397GU10T
HV1397MR16T

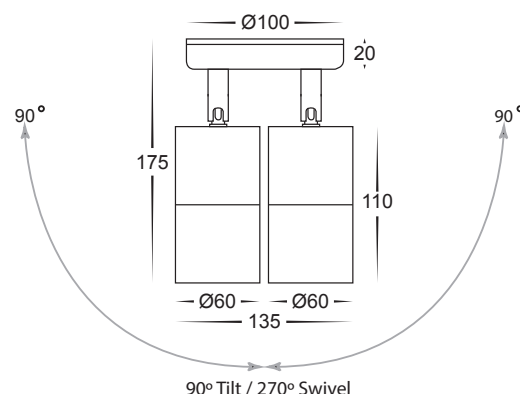

Solid Brass fittings will naturally tarnish. Solid Brass fittings with additional coloured coatings (Antique Brass & Graphite) may tarnish through the coating when installed in outdoor environments.

PART NUMBER	COLOUR TEMP	LUMENS	INPUT	INCLUDED LED
HV1295T	3000K - 4000K - 5500K	240-560lm - 255-595lm - 270-630lm	240v	9 in 1 Tri-Colour 3/5/7w GU10 LED
HV1297GU10T	3000K - 4000K - 5500K	270lm - 285lm - 300lm	240v	Tri-Colour 5w GU10 LED
HV1297MR16T	3000K - 4000K - 5500K	270lm - 285lm - 300lm	12v DC	Tri-Colour 5w MR16 LED
HV1395T	3000K - 4000K - 5500K	2x 240-560lm - 2x 255-595lm - 2x 270-630lm	240v	9 in 1 Tri-Colour 2x 3/5/7w GU10 LED
HV1397GU10T	3000K - 4000K - 5500K	2x 270lm - 2x 285lm - 2x 300lm	240v	Tri-Colour 2x 5w GU10 LED
HV1397MR16T	3000K - 4000K - 5500K	2x 270lm - 2x 285lm - 2x 300lm	12v DC	Tri-Colour 2x 5w MR16 LED
HAVIT COMPATIBLE ACCESSORIES				
HV9507	3000K - 4000K - 5500K	240lm-630lm	12v DC	Tri-Colour 3W/5W/7W MR16 LED
HV9508	3000K - 4000K - 5500K	240lm-630lm	24v DC	Tri-Colour 3W/5W/7W MR16 LED

See pages 295-306 for compatible drivers. All low voltage products that specify an input of 12v or 24v DC must be used with a suitable LED driver.



For detailed product specifications visit www.Havit.com.au or scan this QR code



316 Stainless Steel
HV1305T-PIR
HV1306T-PIR

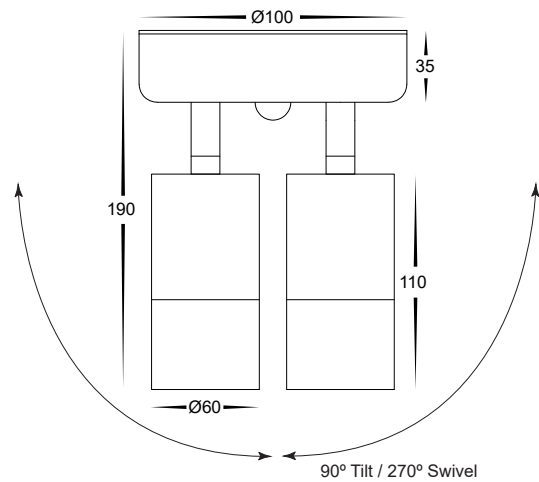

Aluminium Black
HV1325T-PIR
HV1326T-PIR



Aluminium White
HV1335T-PIR
HV1336T-PIR

Tivah Sensor

- 316 Stainless Steel, Aluminium Poly Powder Coated Black or White
- Includes a matching backing plate
- High output reflector to maximise light
- 120° Sensor Detection
- Up to 10m detection range
- Lux and time settings on sensor
- Manual override
- IP Rating: IP65

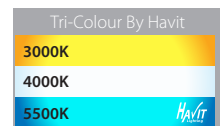

PART NUMBER	COLOUR TEMP	LUMENS	INPUT	INCLUDED LED
HV1305T-PIR	3000K - 4000K - 5500K	2x 240-560lm - 2x 255-595lm - 2x 270-630lm	240v	9 in 1 Tri-Colour 2x 3/5/7w GU10 LED
HV1306T-PIR	3000K - 4000K - 5500K	2x 1080lm - 2x 1140lm - 2x 1200lm	240v	Tri-Colour 2x 12w Built-In LED
HV1325T-PIR	3000K - 4000K - 5500K	2x 240-560lm - 2x 255-595lm - 2x 270-630lm	240v	9 in 1 Tri-Colour 2x 3/5/7w GU10 LED
HV1326T-PIR	3000K - 4000K - 5500K	2x 1080lm - 2x 1140lm - 2x 1200lm	240v	Tri-Colour 2x 12w Built-In LED
HV1335T-PIR	3000K - 4000K - 5500K	2x 240-560lm - 2x 255-595lm - 2x 270-630lm	240v	9 in 1 Tri-Colour 2x 3/5/7w GU10 LED
HV1336T-PIR	3000K - 4000K - 5500K	2x 1080lm - 2x 1140lm - 2x 1200lm	240v	Tri-Colour 2x 12w Built-In LED





HV1071T

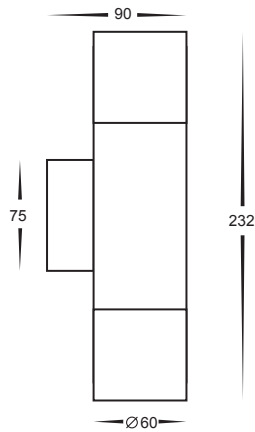

* Base width 46mm



HV1171T

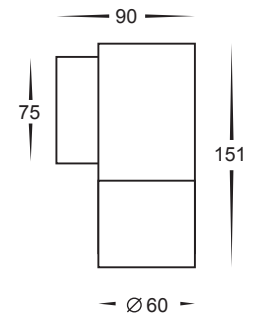

* Base width 46mm



HV1271T

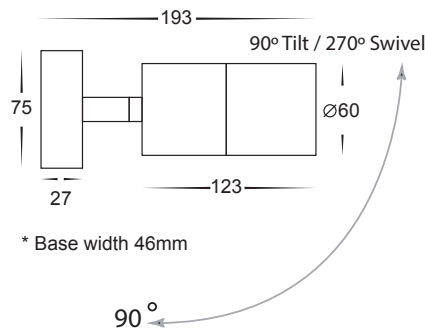

* Base width 46mm

Fortis Stainless Steel

- High Grade 304 Stainless Steel
- IP Rating: IP54

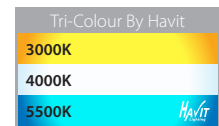

PART NUMBER	COLOUR TEMP	LUMENS	INPUT	INCLUDED LED
HV1071T	3000K - 4000K - 5500K	2x 270lm - 2x 285lm - 2x 300lm	240v	Tri-Colour 2x 5w GU10 LED
HV1171T	3000K - 4000K - 5500K	270lm - 285lm - 300lm	240v	Tri-Colour 5w GU10 LED
HV1271T	3000K - 4000K - 5500K	270lm - 285lm - 300lm	240v	Tri-Colour 5w GU10 LED
HAVIT COMPATIBLE ACCESSORIES				
HV9506D	3000K - 4000K - 5500K	240lm-630lm	240v	Tri-Colour 3W/5W/7W GU10 LED



For detailed product specifications
visit www.Havit.com.au
or scan this QR code



HV1072T

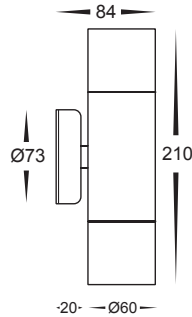

HV1172T

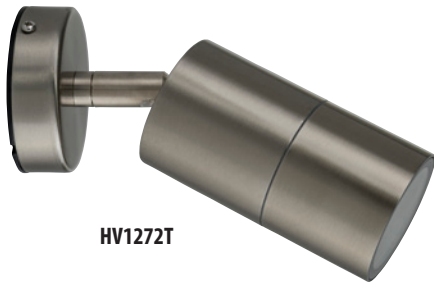
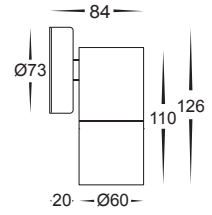

HV1272T

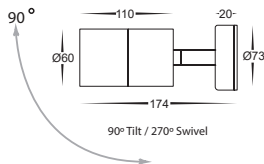

HV1372T

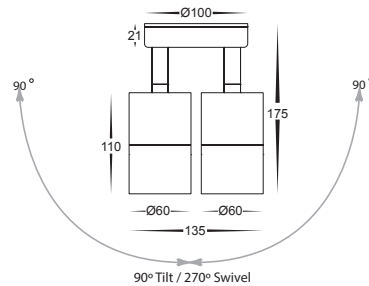

Fortis Stainless Steel

- High Grade 304 Stainless Steel
- IP Rating: IP54

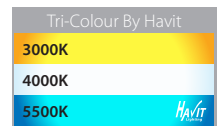

PART NUMBER	COLOUR TEMP	LUMENS	INPUT	INCLUDED LED
HV1072T	3000K - 4000K - 5500K	2x 270lm - 2x 285lm - 2x 300lm	240v	Tri-Colour 2x 5w GU10 LED
HV1172T	3000K - 4000K - 5500K	270lm - 285lm - 300lm	240v	Tri-Colour 5w GU10 LED
HV1272T	3000K - 4000K - 5500K	270lm - 285lm - 300lm	240v	Tri-Colour 5w GU10 LED
HV1372T	3000K - 4000K - 5500K	2x 270lm - 2x 285lm - 2x 300lm	240v	Tri-Colour 2x 5w GU10 LED
HAVIT COMPATIBLE ACCESSORIES				
HV9506D	3000K - 4000K - 5500K	240lm-630lm	240v	Tri-Colour 3W/5W/7W GU10 LED



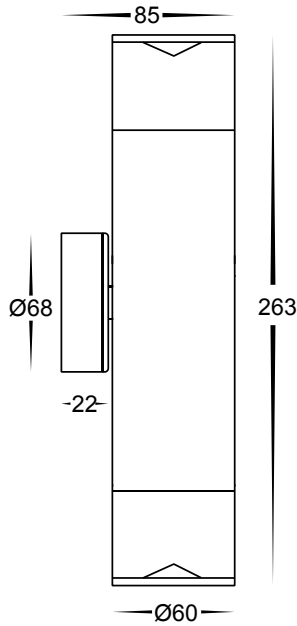

**Aluminium Titanium
HV1089T-TTM-240V**



**Aluminium Black
HV1089T-BLK-240V**

Highlite Aluminium

- Titanium Coloured Aluminium and Aluminium Poly Powder Coated Black
- Includes a matching aluminium backing plate
- High grade perspex reflector lens
- IP Rating: IP65

Suitable for use with LED globes only

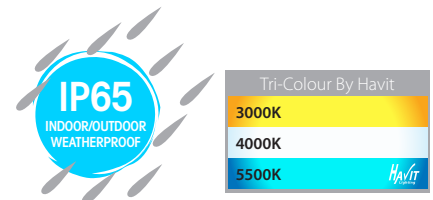

PART NUMBER	COLOUR TEMP	LUMENS	INPUT	INCLUDED LED
HV1089T-TTM-240V	3000K - 4000K - 5500K	2x 270lm - 2x 285lm - 2x 300lm	240v	Tri-Colour 2x 5w GU10 LED
HV1089T-BLK-240V	3000K - 4000K - 5500K	2x 270lm - 2x 285lm - 2x 300lm	240v	Tri-Colour 2x 5w GU10 LED
HAVIT COMPATIBLE ACCESSORIES				
HV9506D	3000K - 4000K - 5500K	240lm-630lm	240v	Tri-Colour 3W/5W/7W GU10 LED



For detailed product specifications
visit www.Havit.com.au
or scan this QR code

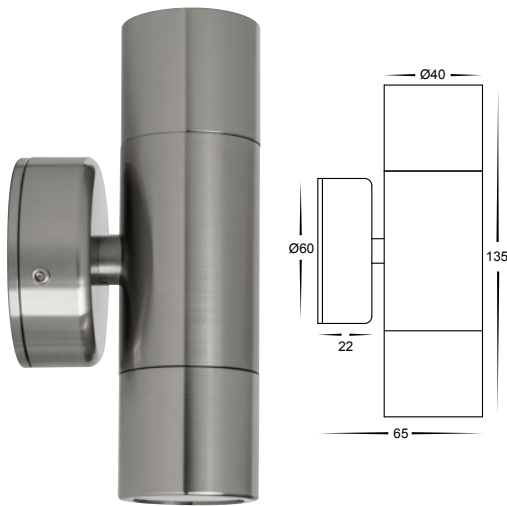

HV1007MR11NW

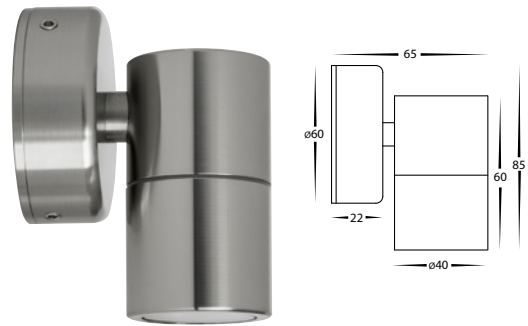

HV1107MR11NW

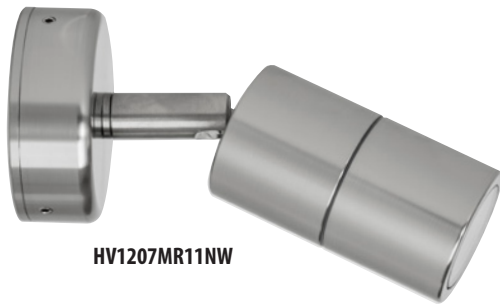

HV1207MR11NW



HV1307MR11NW

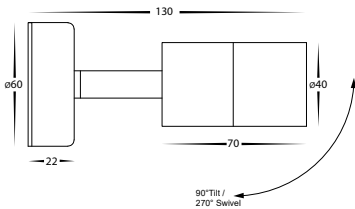

90° Tilt / 270° Swivel

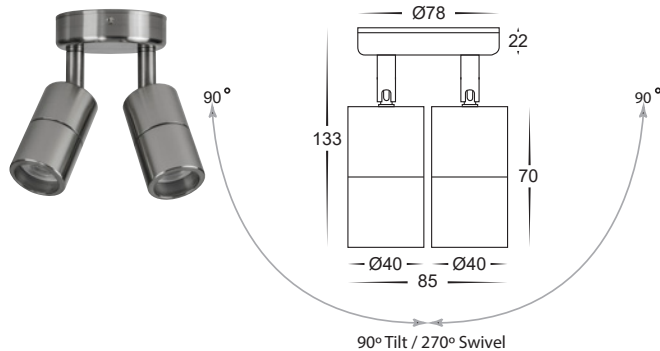

90° Tilt / 270° Swivel

Tivah Mini 316 Stainless Steel

- Stainless Steel 316 Marine Grade
- Includes a matching backing plate
- High output reflector to maximise light
- IP Rating: IP65



PART NUMBER	COLOUR TEMP	LUMENS	INPUT	INCLUDED LED
HV1007MR11NW	3000K + 4000K	2x 270lm - 2x 300lm	12v DC	2x 3w 3000K MR11 LED + 2x 3w 4000K MR11 LED
HV1107MR11NW	3000K + 4000K	270lm - 300lm	12v DC	3w 3000K MR11 LED + 3w 4000K MR11 LED
HV1207MR11NW	3000K + 4000K	270lm - 300lm	12v DC	3w 3000K MR11 LED + 3w 4000K MR11 LED
HV1307MR11NW	3000K + 4000K	2x 270lm - 2x 300lm	12v DC	2x 3w 3000K MR11 LED + 2x 3w 4000K MR11 LED

HAVIT COMPATIBLE ACCESSORIES

See pages 295-306 for compatible drivers. All low voltage products that specify an input of 12v or 24v DC must be used with a suitable LED driver.





HV1027MR11NW

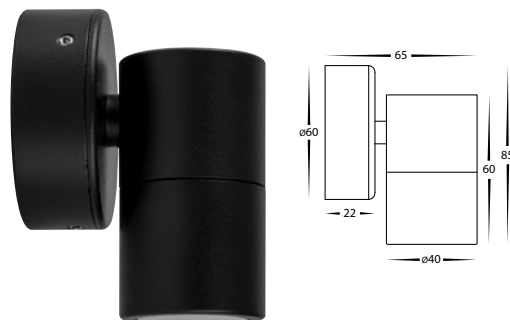

HV1127MR11NW



HV1227MR11NW



HV1327MR11NW

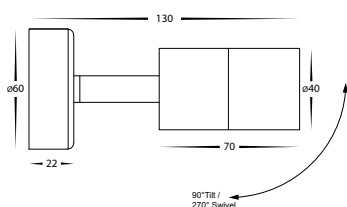

90° Tilt / 270° Swivel

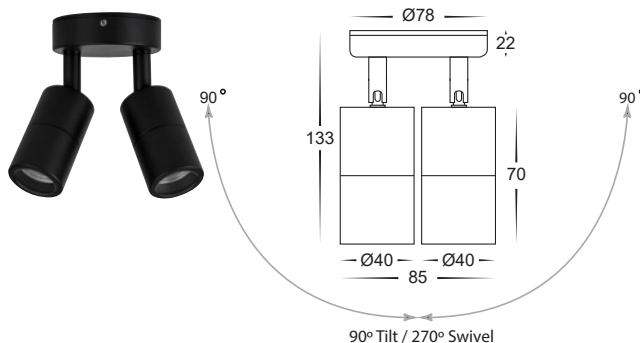

90° Tilt / 270° Swivel

Tivah Mini Aluminium Black

- Aluminium Poly Powder Coated Black
- Includes a matching aluminium backing plate
- High output reflector to maximise light
- IP Rating: IP65



PART NUMBER	COLOUR TEMP	LUMENS	INPUT	INCLUDED LED
HV1027MR11NW	3000K + 4000K	2x 270lm - 2x 300lm	12v DC	2x 3w 3000K MR11 LED + 2x 3w 4000K MR11 LED
HV1127MR11NW	3000K + 4000K	270lm - 300lm	12v DC	3w 3000K MR11 LED + 3w 4000K MR11 LED
HV1227MR11NW	3000K + 4000K	270lm - 300lm	12v DC	3w 3000K MR11 LED + 3w 4000K MR11 LED
HV1327MR11NW	3000K + 4000K	2x 270lm - 2x 300lm	12v DC	2x 3w 3000K MR11 LED + 2x 3w 4000K MR11 LED

HAVIT COMPATIBLE ACCESSORIES

See pages 295-306 for compatible drivers. All low voltage products that specify an input of 12v or 24v DC must be used with a suitable LED driver.



For detailed product specifications visit www.Havit.com.au or scan this QR code

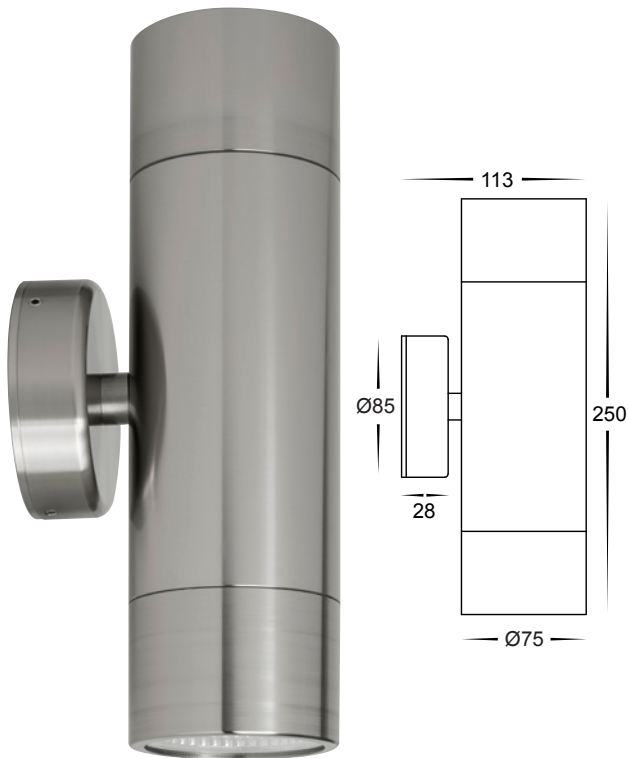

HV1008T

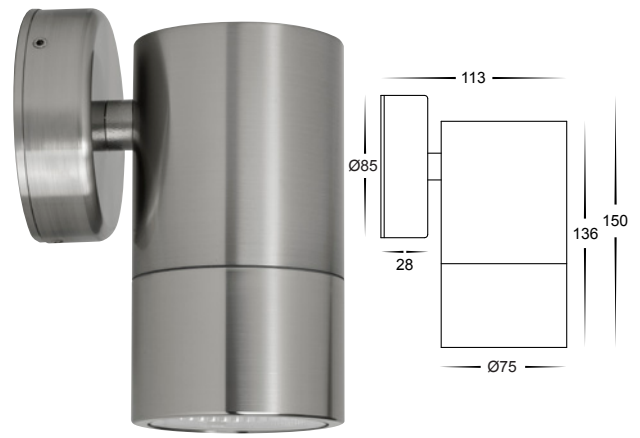

HV1108T



HV1208T

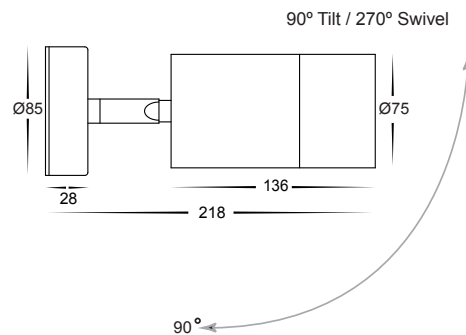

Tivah Maxi 316 Stainless Steel

- 316 Stainless Steel
- Includes a matching backing plate
- High output reflector to maximise light
- IP Rating: IP65

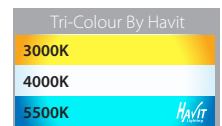

PART NUMBER	COLOUR TEMP	LUMENS	INPUT	INCLUDED LED
HV1008T	3000K - 4000K - 5500K	2x 1080lm - 2x 1140lm - 2x 1200lm	240v	Tri-Colour Built-in 2x 12w COB LED
HV1108T	3000K - 4000K - 5500K	1080lm - 1140lm - 1200lm	240v	Tri-Colour Built-in 12w COB LED
HV1208T	3000K - 4000K - 5500K	1080lm - 1140lm - 1200lm	240v	Tri-Colour Built-in 12w COB LED



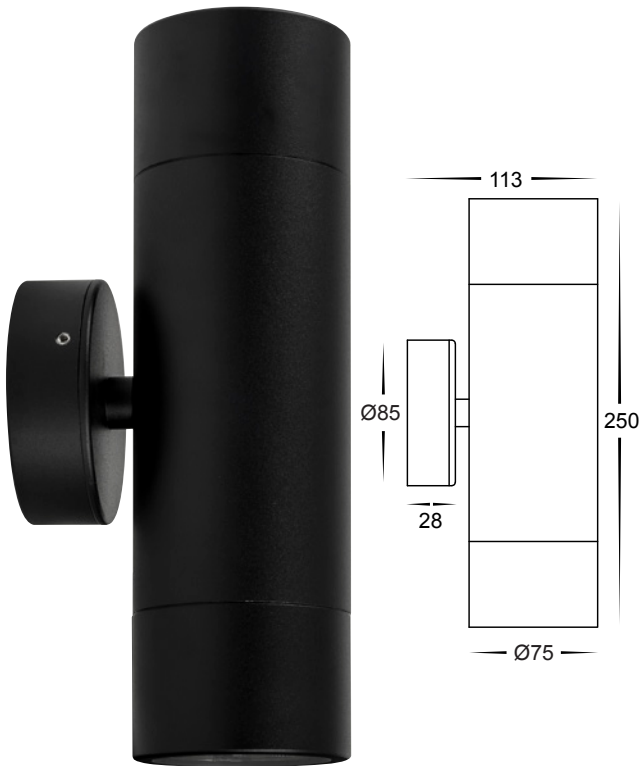

HV1028T

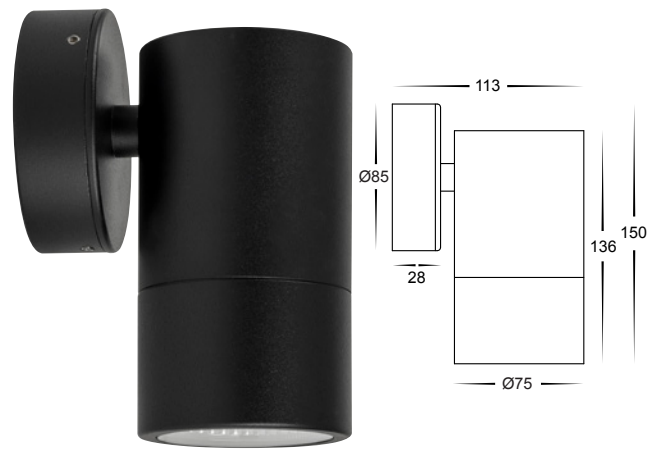

HV1128T



HV1228T

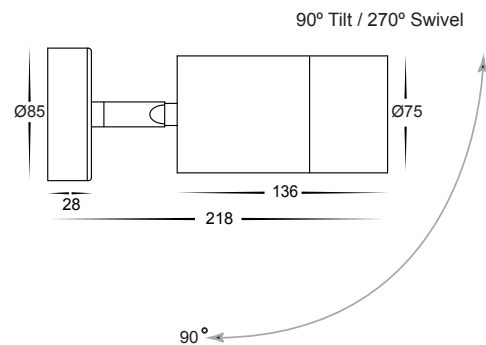

Tivah Maxi Aluminium Black

- Aluminium Poly Powder Coated Black
- Includes a matching aluminium backing plate
- High output reflector to maximise light
- IP Rating: IP65

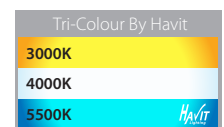

PART NUMBER	COLOUR TEMP	LUMENS	INPUT	INCLUDED LED
HV1028T	3000K - 4000K - 5500K	2x 1080lm - 2x 1140lm - 2x 1200lm	240v	Tri-Colour Built-in 2x 12w COB LED
HV1128T	3000K - 4000K - 5500K	1080lm - 1140lm - 1200lm	240v	Tri-Colour Built-in 12w COB LED
HV1228T	3000K - 4000K - 5500K	1080lm - 1140lm - 1200lm	240v	Tri-Colour Built-in 12w COB LED



For detailed product specifications
visit www.Havit.com.au
or scan this QR code



HV10291T



HV10391T

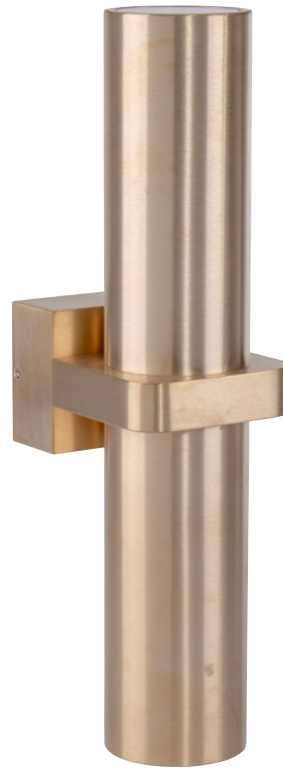

HV10591T

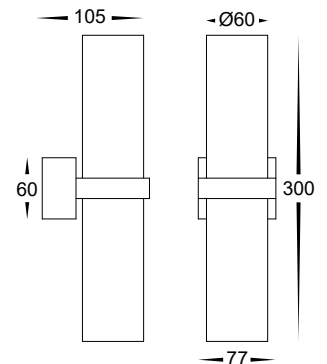

i Solid Brass fittings will naturally tarnish. Solid Brass fittings with additional coloured coatings (Antique Brass & Graphite) may tarnish through the coating when installed in outdoor environments.

Luz

- Up & Down Wall Light
- Solid Brass or Aluminium Poly Powder Coated Black or White
- Includes a matching backing plate
- Triac Dimmable
- IP Rating: IP65

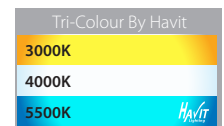

PART NUMBER	COLOUR TEMP	LUMENS	INPUT	INCLUDED LED
HV10291T	3000K - 4000K - 5500K	2x 240-560lm - 2x 255-595lm - 2x 270-630lm	240v	9 in 1 Tri-Colour 2x 3/5/7w GU10 LED
HV10391T	3000K - 4000K - 5500K	2x 240-560lm - 2x 255-595lm - 2x 270-630lm	240v	9 in 1 Tri-Colour 2x 3/5/7w GU10 LED
HV10591T	3000K - 4000K - 5500K	2x 240-560lm - 2x 255-595lm - 2x 270-630lm	240v	9 in 1 Tri-Colour 2x 3/5/7w GU10 LED





HV10292T



HV10392T



HV10592T

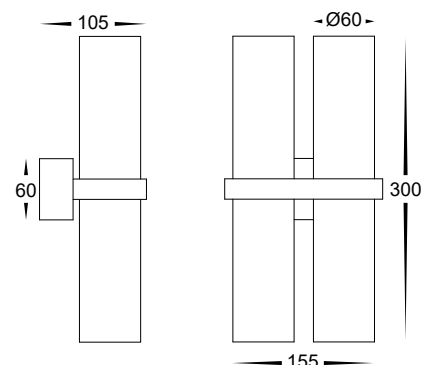
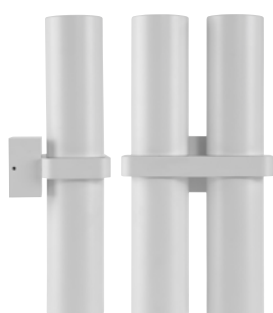

i Solid Brass fittings will naturally tarnish. Solid Brass fittings with additional coloured coatings (Antique Brass & Graphite) may tarnish through the coating when installed in outdoor environments.

Luz

- Up & Down Wall Light
- Solid Brass or Aluminium Poly Powder Coated Black or White
- Includes a matching backing plate
- Triac Dimmable
- IP Rating: IP65

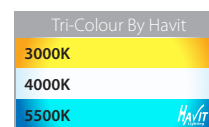

PART NUMBER	COLOUR TEMP	LUMENS	INPUT	INCLUDED LED
HV10292T	3000K - 4000K - 5500K	4x 240-560lm - 4x 255-595lm - 4x 270-630lm	240v	9 in 1 Tri-Colour 4x 3/5/7w GU10 LED
HV10392T	3000K - 4000K - 5500K	4x 240-560lm - 4x 255-595lm - 4x 270-630lm	240v	9 in 1 Tri-Colour 4x 3/5/7w GU10 LED
HV10592T	3000K - 4000K - 5500K	4x 240-560lm - 4x 255-595lm - 4x 270-630lm	240v	9 in 1 Tri-Colour 4x 3/5/7w GU10 LED



For detailed product specifications visit www.Havit.com.au or scan this QR code



Pointe 316 Stainless Steel

- Single adjustable spike spotlight
- Stainless Steel 316 Marine Grade and 316 Stainless Steel Poly Powder Coated Black
- 2x 235mm spike length (total 470mm)
- 2m reinforced cable
- IP Rating: IP65

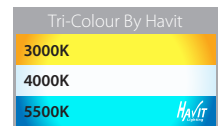

PART NUMBER	COLOUR TEMP	LUMENS	INPUT	INCLUDED LED
HV1401T	3000K - 4000K - 5500K	270lm - 285lm - 300lm	12v DC	Tri-Colour 5w MR16 LED
HV1401T-BLK	3000K - 4000K - 5500K	270lm - 285lm - 300lm	12v DC	Tri-Colour 5w MR16 LED
HAVIT COMPATIBLE ACCESSORIES				
HV9507	3000K - 4000K - 5500K	240lm-630lm	12v DC	Tri-Colour 3W/5W/7W MR16 LED
HV9508	3000K - 4000K - 5500K	240lm-630lm	24v DC	Tri-Colour 3W/5W/7W MR16 LED

See pages 295-306 for compatible drivers. All low voltage products that specify an input of 12v or 24v DC must be used with a suitable LED driver.



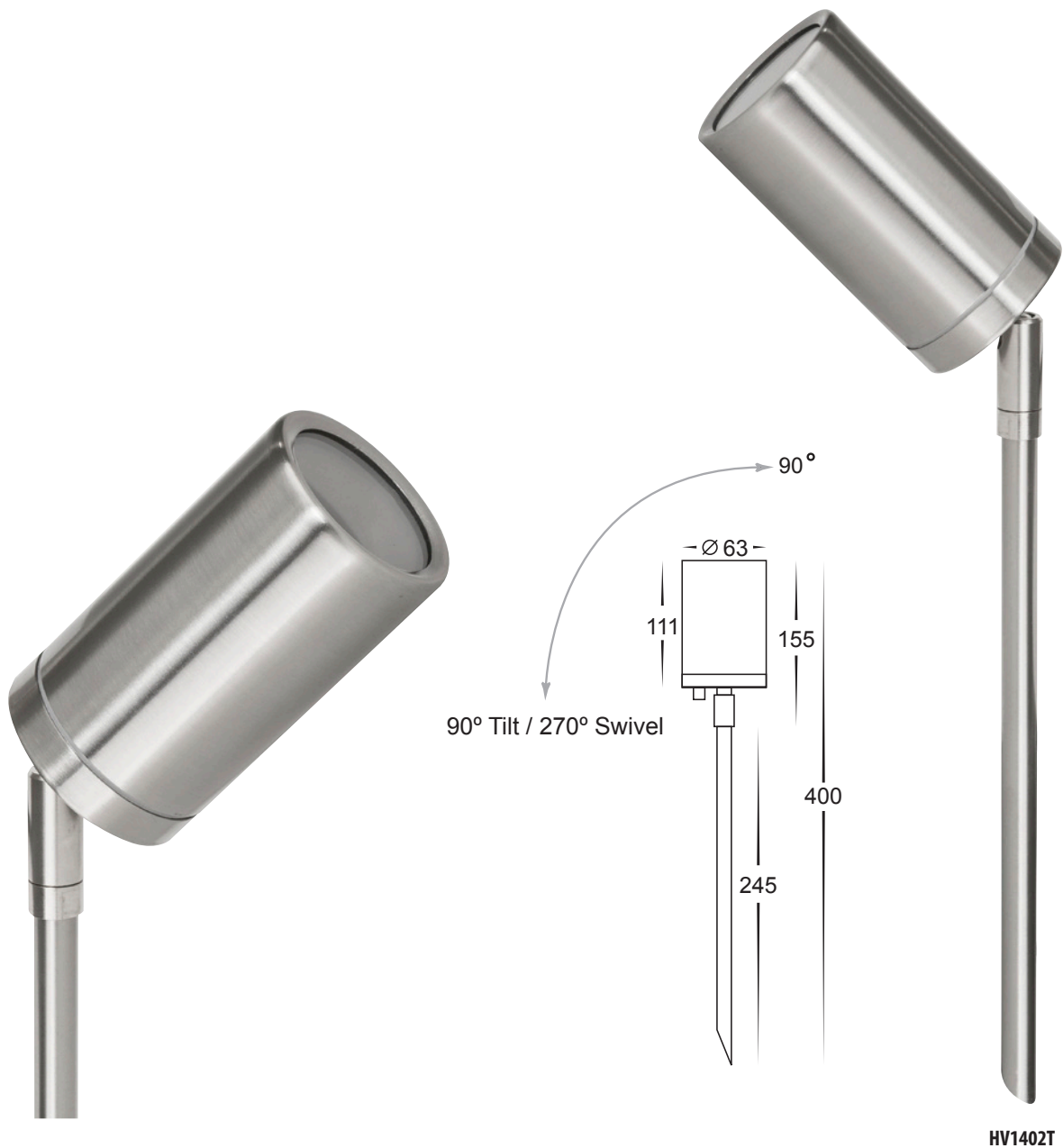

HV1402T

Eden 316 Stainless Steel

- Single adjustable spike spotlight
- Stainless Steel 316 Marine Grade
- 245mm spike length
- 2m reinforced cable
- IP Rating: IP65

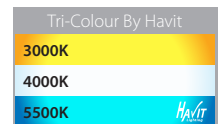

PART NUMBER	COLOUR TEMP	LUMENS	INPUT	INCLUDED LED
HV1402T	3000K - 4000K - 5500K	270lm - 285lm - 300lm	12v DC	Tri-Colour 5w MR16 LED
HAVIT COMPATIBLE ACCESSORIES				
HV9507	3000K - 4000K - 5500K	240lm-630lm	12v DC	Tri-Colour 3W/5W/7W MR16 LED
HV9508	3000K - 4000K - 5500K	240lm-630lm	24v DC	Tri-Colour 3W/5W/7W MR16 LED

See pages 295-306 for compatible drivers. All low voltage products that specify an input of 12v or 24v DC must be used with a suitable LED driver.



For detailed product specifications visit www.Havit.com.au or scan this QR code



HV1407T-SS316
Single Adjustable

HV1403T-SS316
Single Adjustable

HV1405T-SS316
Double Adjustable

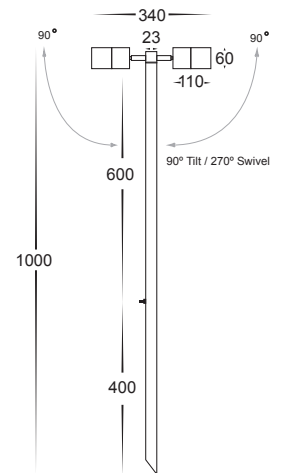
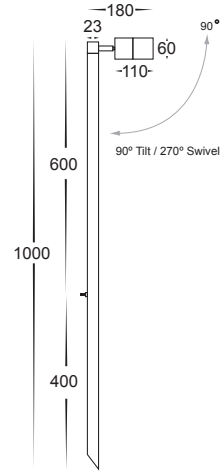
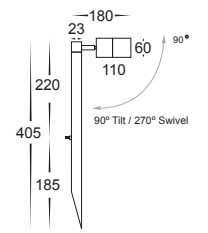

Tivah 316 Stainless Steel

- Adjustable spike spotlight
- Stainless Steel 316 Marine Grade
- Internal cable
- 405mm & 1000mm spike length
- 2m reinforced cable
- IP Rating: IP65

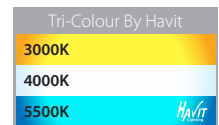

PART NUMBER	COLOUR TEMP	LUMENS	INPUT	INCLUDED LED
HV1403T-SS316	3000K - 4000K - 5500K	270lm - 285lm - 300lm	12v DC	Tri-Colour 5w MR16 LED
HV1405T-SS316	3000K - 4000K - 5500K	2x 270lm - 2x 285lm - 2x 300lm	12v DC	Tri-Colour 2x 5w MR16 LED
HV1407T-SS316	3000K - 4000K - 5500K	270lm - 285lm - 300lm	12v DC	Tri-Colour 5w MR16 LED
HAVIT COMPATIBLE ACCESSORIES				
HV9507	3000K - 4000K - 5500K	240lm-630lm	12v DC	Tri-Colour 3W/5W/7W MR16 LED
HV9508	3000K - 4000K - 5500K	240lm-630lm	24v DC	Tri-Colour 3W/5W/7W MR16 LED

See pages 295-306 for compatible drivers. All low voltage products that specify an input of 12v or 24v DC must be used with a suitable LED driver.



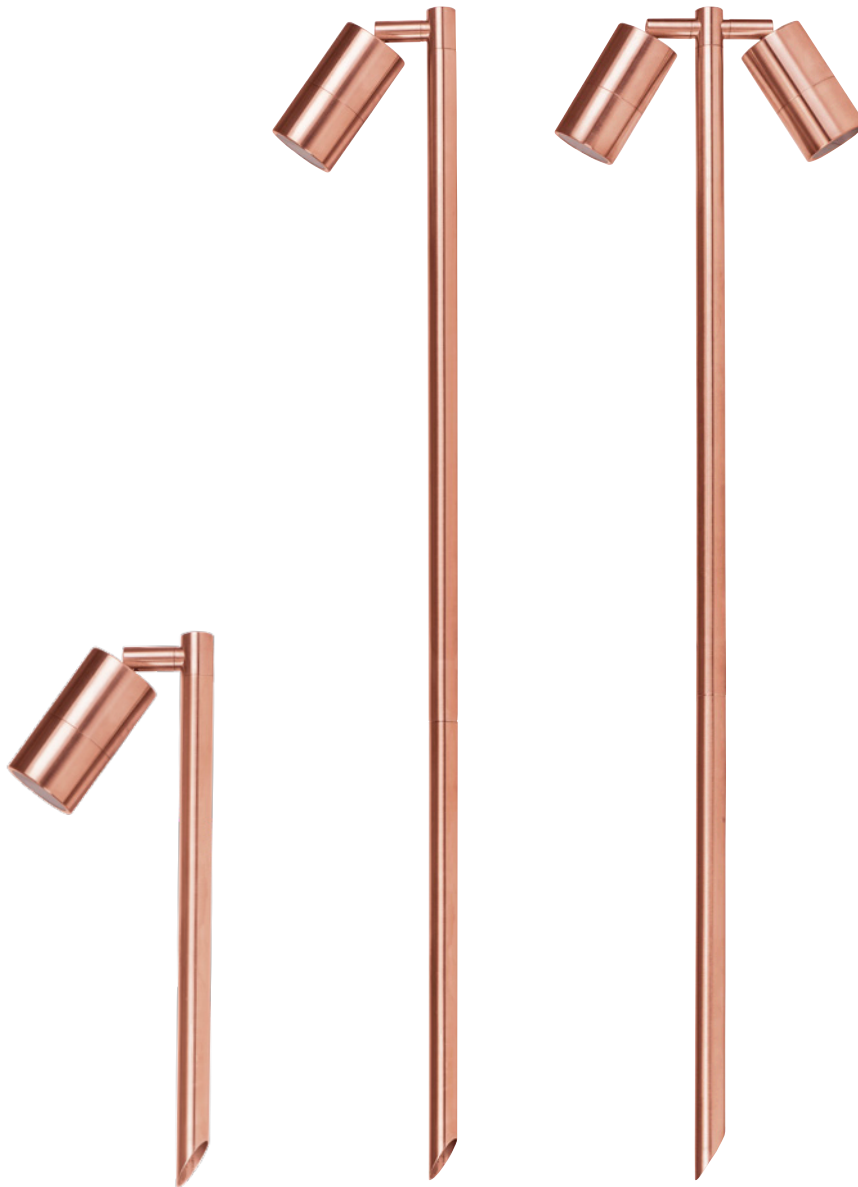

HV1413T
Single Adjustable

HV1403T-CP
Single Adjustable

HV1405T-CP
Double Adjustable

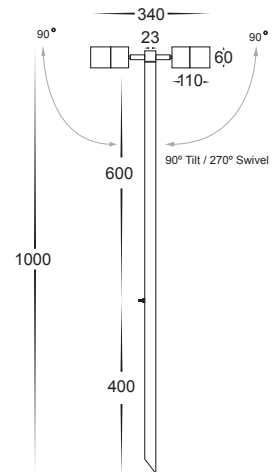
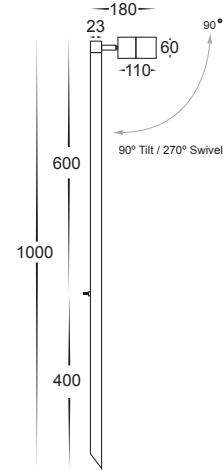
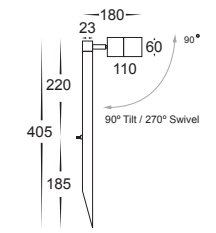

Tivah Solid Copper

- Adjustable spike spotlight
- Solid Copper
- Fast weathering for classic aged appearance
- Internal cable
- 405mm & 1000mm spike length
- 2m reinforced cable
- IP Rating: IP65

Weathered Copper

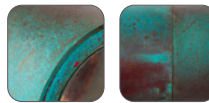

Solid Brass and Solid Copper fittings will naturally tarnish. Solid Brass fittings with additional coloured coatings (Antique Brass & Graphite) may tarnish through the coating when installed in outdoor environments.

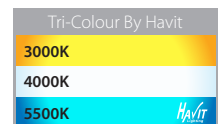

PART NUMBER	COLOUR TEMP	LUMENS	INPUT	INCLUDED LED
HV1403T-CP	3000K - 4000K - 5500K	270lm - 285lm - 300lm	12v DC	Tri-Colour 5w MR16 LED
HV1405T-CP	3000K - 4000K - 5500K	2x 270lm - 2x 285lm - 2x 300lm	12v DC	Tri-Colour 2x 5w MR16 LED
HV1413T	3000K - 4000K - 5500K	270lm - 285lm - 300lm	12v DC	Tri-Colour 5w MR16 LED
HAVIT COMPATIBLE ACCESSORIES				
HV9507	3000K - 4000K - 5500K	240lm-630lm	12v DC	Tri-Colour 3W/5W/7W MR16 LED
HV9508	3000K - 4000K - 5500K	240lm-630lm	24v DC	Tri-Colour 3W/5W/7W MR16 LED

See pages 295-306 for compatible drivers. All low voltage products that specify an input of 12v or 24v DC must be used with a suitable LED driver.



For detailed product specifications visit www.Havit.com.au or scan this QR code

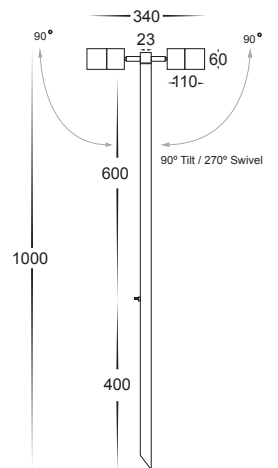
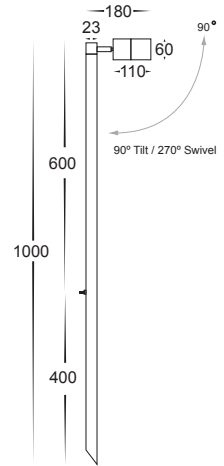
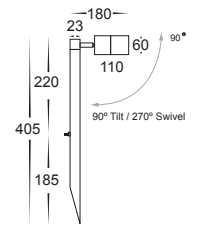

HV1407T-AB
Single Adjustable

HV1403T-AB
Single Adjustable

HV1405T-AB
Double Adjustable

Tivah Antique Brass

- Adjustable spike spotlight
- Solid Brass With Antique Brass Finish
- Internal cable
- 405mm & 1000mm spike length
- 2m reinforced cable
- IP Rating: IP65

i Solid Brass fittings will naturally tarnish. Solid Brass fittings with additional coloured coatings (Antique Brass & Graphite) may tarnish through the coating when installed in outdoor environments.

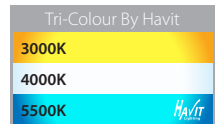

PART NUMBER	COLOUR TEMP	LUMENS	INPUT	INCLUDED LED
HV1403T-AB	3000K - 4000K - 5500K	270lm - 285lm - 300lm	12v DC	Tri-Colour 5w MR16 LED
HV1405T-AB	3000K - 4000K - 5500K	2x 270lm - 2x 285lm - 2x 300lm	12v DC	Tri-Colour 2x 5w MR16 LED
HV1407T-AB	3000K - 4000K - 5500K	270lm - 285lm - 300lm	12v DC	Tri-Colour 5w MR16 LED
HAVIT COMPATIBLE ACCESSORIES				
HV9507	3000K - 4000K - 5500K	240lm-630lm	12v DC	Tri-Colour 3W/5W/7W MR16 LED
HV9508	3000K - 4000K - 5500K	240lm-630lm	24v DC	Tri-Colour 3W/5W/7W MR16 LED

See pages 295-306 for compatible drivers. All low voltage products that specify an input of 12v or 24v DC must be used with a suitable LED driver.



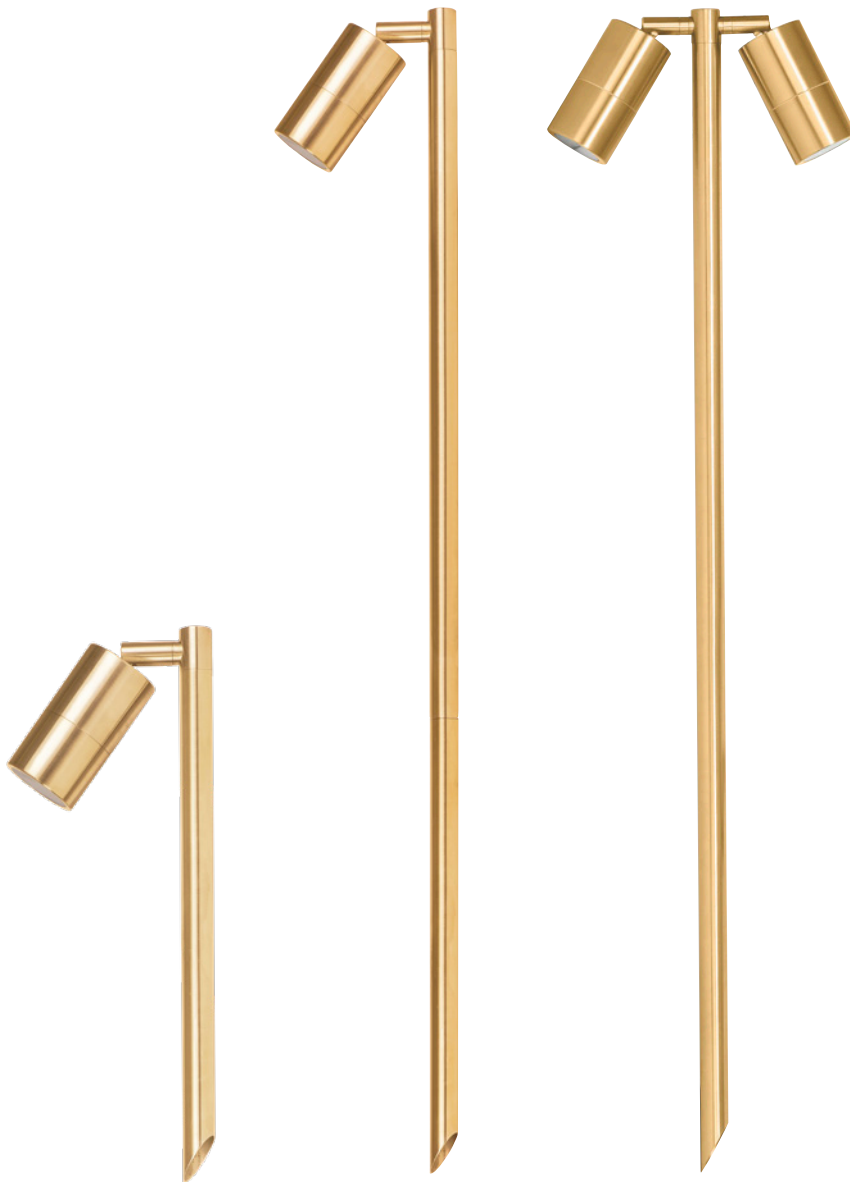

HV1407T-BR
Single Adjustable

HV1403T-BR
Single Adjustable

HV1405T-BR
Double Adjustable

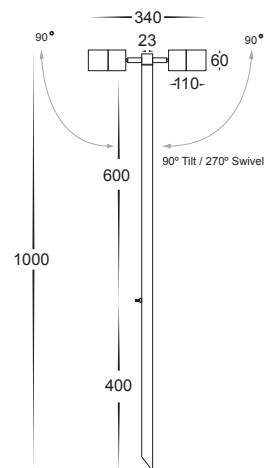
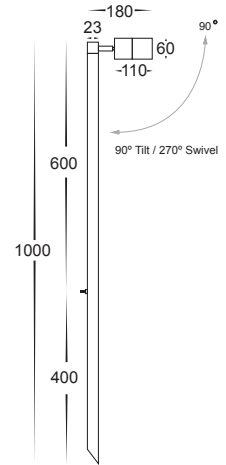
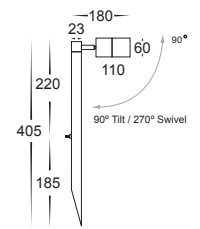

Tivah Solid Brass

- Adjustable spike spotlight
- Solid Brass
- Internal cable
- 405mm & 1000mm spike length
- 2m reinforced cable
- IP Rating: IP65

i Solid Brass fittings will naturally tarnish. Solid Brass fittings with additional coloured coatings (Antique Brass & Graphite) may tarnish through the coating when installed in outdoor environments.

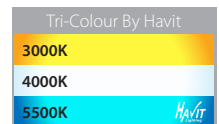

PART NUMBER	COLOUR TEMP	LUMENS	INPUT	INCLUDED LED
HV1403T-BR	3000K - 4000K - 5500K	270lm - 285lm - 300lm	12v DC	Tri-Colour 5w MR16 LED
HV1405T-BR	3000K - 4000K - 5500K	2x 270lm - 2x 285lm - 2x 300lm	12v DC	Tri-Colour 2x 5w MR16 LED
HV1407T-BR	3000K - 4000K - 5500K	270lm - 285lm - 300lm	12v DC	Tri-Colour 5w MR16 LED
HAVIT COMPATIBLE ACCESSORIES				
HV9507	3000K - 4000K - 5500K	240lm-630lm	12v DC	Tri-Colour 3W/5W/7W MR16 LED
HV9508	3000K - 4000K - 5500K	240lm-630lm	24v DC	Tri-Colour 3W/5W/7W MR16 LED

See pages 295-306 for compatible drivers. All low voltage products that specify an input of 12v or 24v DC must be used with a suitable LED driver.



For detailed product specifications visit www.Havit.com.au or scan this QR code

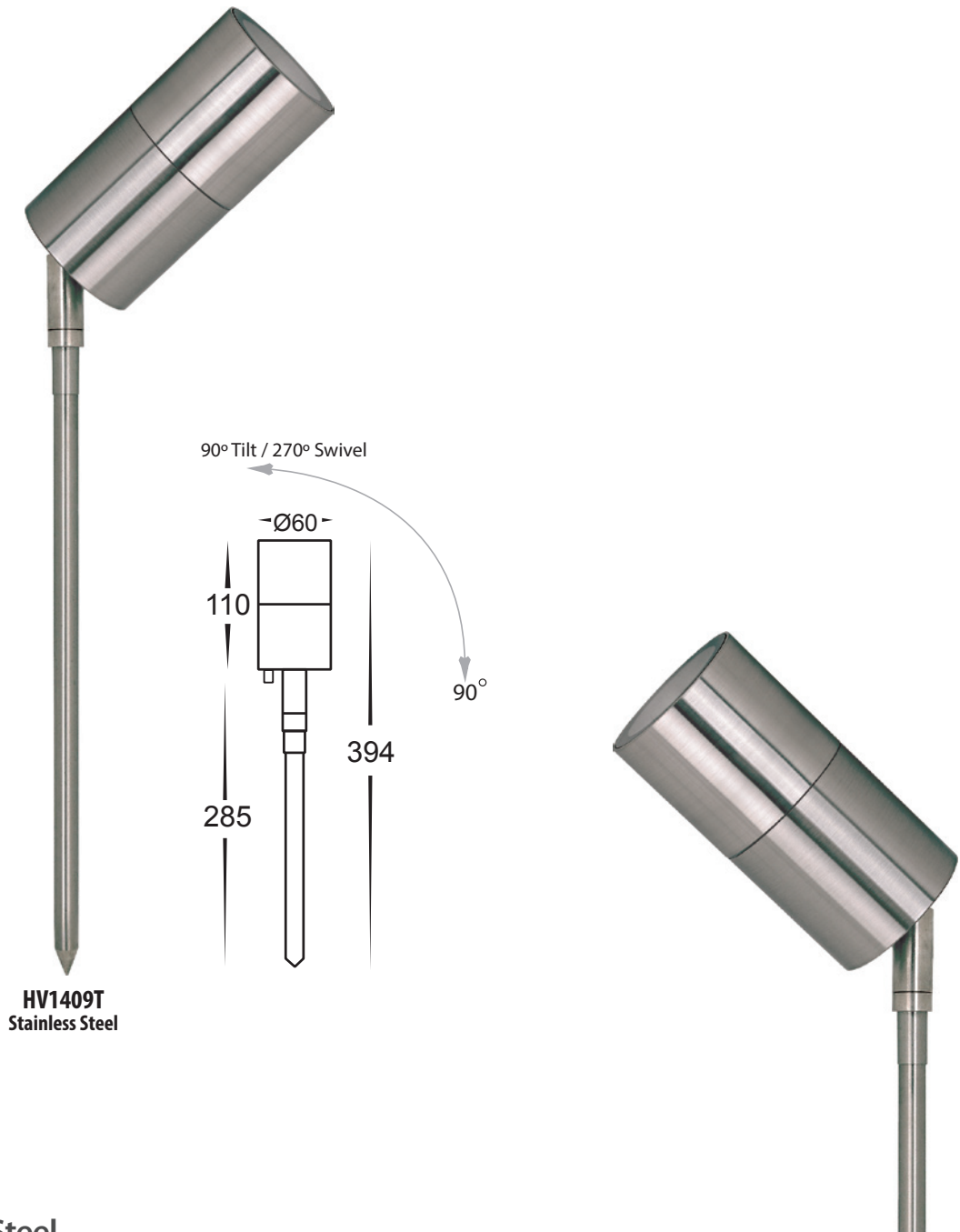

HV1409T
Stainless Steel

Fortis Stainless Steel

- Single adjustable spike spotlight
- High Grade 304 Stainless Steel
- 285mm spike length
- 2m reinforced cable
- IP Rating: IP54

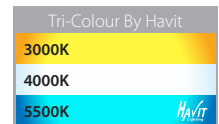

PART NUMBER	COLOUR TEMP	LUMENS	INPUT	INCLUDED LED
HV1409T	3000K - 4000K - 5500K	270lm - 285lm - 300lm	12v DC	Tri-Colour 5w MR16 LED
HAVIT COMPATIBLE ACCESSORIES				
HV9507	3000K - 4000K - 5500K	240lm-630lm	12v DC	Tri-Colour 3W/5W/7W MR16 LED
HV9508	3000K - 4000K - 5500K	240lm-630lm	24v DC	Tri-Colour 3W/5W/7W MR16 LED

See pages 295-306 for compatible drivers. All low voltage products that specify an input of 12v or 24v DC must be used with a suitable LED driver.



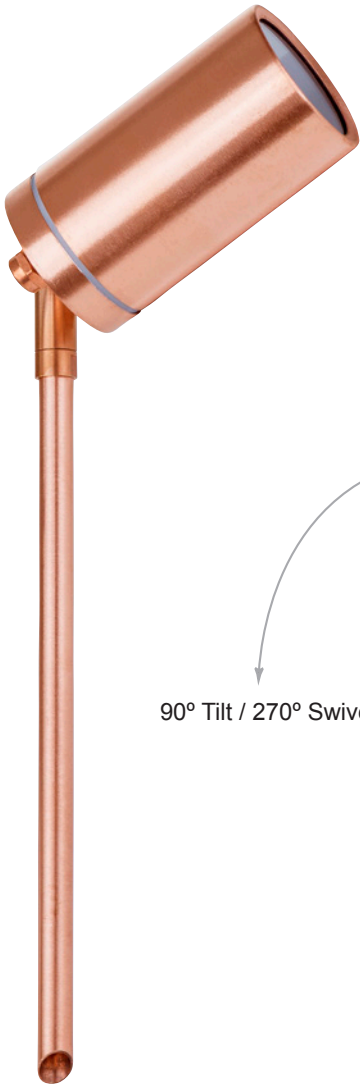

HV1412T
Solid Copper

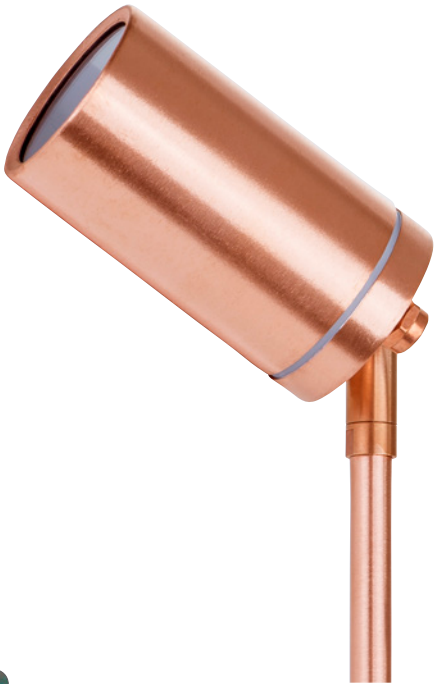
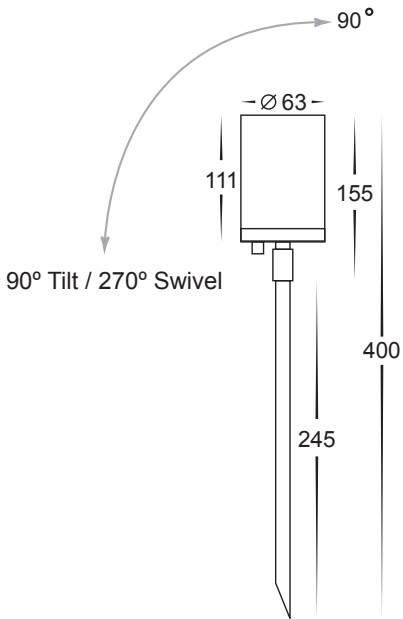

Eden Copper

- Single adjustable spike spotlight
- Solid Copper
- Fast weathering for classic aged appearance
- Spike length: 245mm
- 2m reinforced cable
- IP Rating: IP65

Weathered Copper

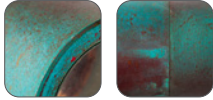

i Solid Brass and Solid Copper fittings will naturally tarnish. Solid Brass fittings with additional coloured coatings (Antique Brass & Graphite) may tarnish through the coating when installed in outdoor environments.

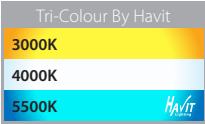

PART NUMBER	COLOUR TEMP	LUMENS	INPUT	INCLUDED LED
HV1412T	3000K - 4000K - 5500K	270lm - 285lm - 300lm	12v DC	Tri-Colour 5w MR16 LED
HAVIT COMPATIBLE ACCESSORIES				
HV9507	3000K - 4000K - 5500K	240lm-630lm	12v DC	Tri-Colour 3W/5W/7W MR16 LED
HV9508	3000K - 4000K - 5500K	240lm-630lm	24v DC	Tri-Colour 3W/5W/7W MR16 LED

See pages 295-306 for compatible drivers. All low voltage products that specify an input of 12v or 24v DC must be used with a suitable LED driver.



For detailed product specifications visit www.Havit.com.au or scan this QR code

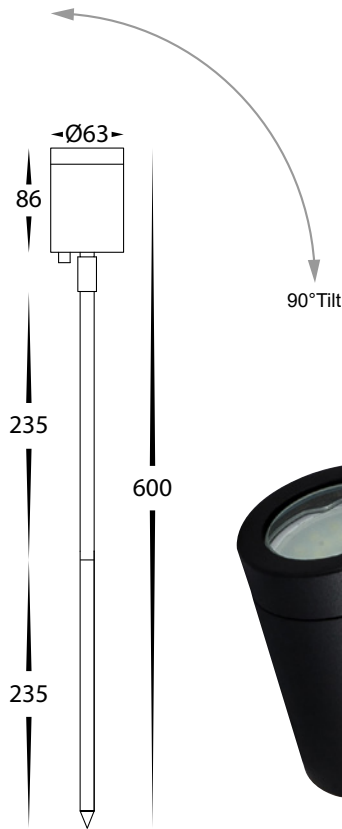

HV1421T
Aluminium Black

HV1421T-WHT
Aluminium White

Pointe Aluminium

- Single adjustable spike spotlight
- Aluminium Poly Powder Coated Black and White
- 2x 235mm spike length (total 470mm)
- 2m reinforced cable
- IP Rating: IP65

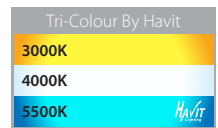

PART NUMBER	COLOUR TEMP	LUMENS	INPUT	INCLUDED LED
HV1421T	3000K - 4000K - 5500K	270lm - 285lm - 300lm	12v DC	Tri-Colour 5w MR16 LED
HV1421T-WHT	3000K - 4000K - 5500K	270lm - 285lm - 300lm	12v DC	Tri-Colour 5w MR16 LED
HAVIT COMPATIBLE ACCESSORIES				
HV9507	3000K - 4000K - 5500K	240lm-630lm	12v DC	Tri-Colour 3W/5W/7W MR16 LED
HV9508	3000K - 4000K - 5500K	240lm-630lm	24v DC	Tri-Colour 3W/5W/7W MR16 LED

See pages 295-306 for compatible drivers. All low voltage products that specify an input of 12v or 24v DC must be used with a suitable LED driver.



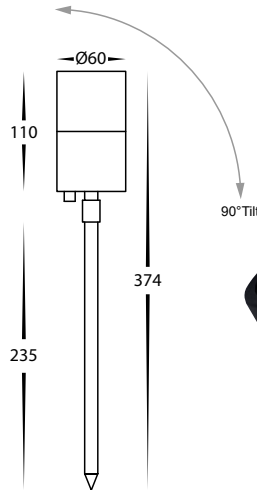

HV1427T
Aluminium Black

HV1427T -WHT
Aluminium White

HV1427T-SSBLK
316 Stainless Steel Black

Tivah

- Single adjustable spike spotlight
- 316 Stainless Steel Black and Aluminium Poly Powder Coated Black and White
- 235mm spike length
- 2m reinforced cable
- IP Rating: IP65

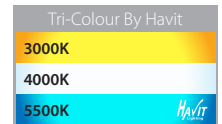

PART NUMBER	COLOUR TEMP	LUMENS	INPUT	INCLUDED LED
HV1427T-SSBLK	3000K - 4000K - 5500K	270lm - 285lm - 300lm	12v DC	Tri-Colour 5w MR16 LED
HV1427T	3000K - 4000K - 5500K	270lm - 285lm - 300lm	12v DC	Tri-Colour 5w MR16 LED
HV1427T-WHT	3000K - 4000K - 5500K	270lm - 285lm - 300lm	12v DC	Tri-Colour 5w MR16 LED
HAVIT COMPATIBLE ACCESSORIES				
HV9507	3000K - 4000K - 5500K	240lm-630lm	12v DC	Tri-Colour 3W/5W/7W MR16 LED
HV9508	3000K - 4000K - 5500K	240lm-630lm	24v DC	Tri-Colour 3W/5W/7W MR16 LED

See pages 295-306 for compatible drivers. All low voltage products that specify an input of 12v or 24v DC must be used with a suitable LED driver.



For detailed product specifications
visit www.Havit.com.au
or scan this QR code



HV1423MR11NW
Single Adjustable



HV1425MR11NW
Double Adjustable

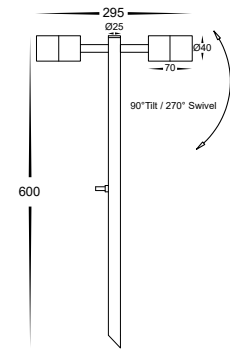
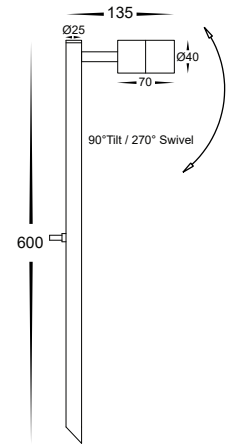

Tivah Mini Aluminium Black

- Adjustable spike spotlight
- Aluminium Poly Powder Coated Black
- Internal Cable
- 600mm length
- 2m reinforced cable
- IP Rating: IP65



PART NUMBER	COLOUR TEMP	LUMENS	INPUT	INCLUDED LED
HV1423MR11NW	3000K + 4000K	270lm - 300lm	12v DC	3w 3000K MR11 LED + 3w 4000K MR11 LED
HV1425MR11NW	3000K + 4000K	2x 270lm - 2x 300lm	12v DC	2x 3w 3000K MR11 LED + 2x 3w 4000K MR11 LED

See pages 295-306 for compatible drivers. All low voltage products that specify an input of 12v or 24v DC must be used with a suitable LED driver.



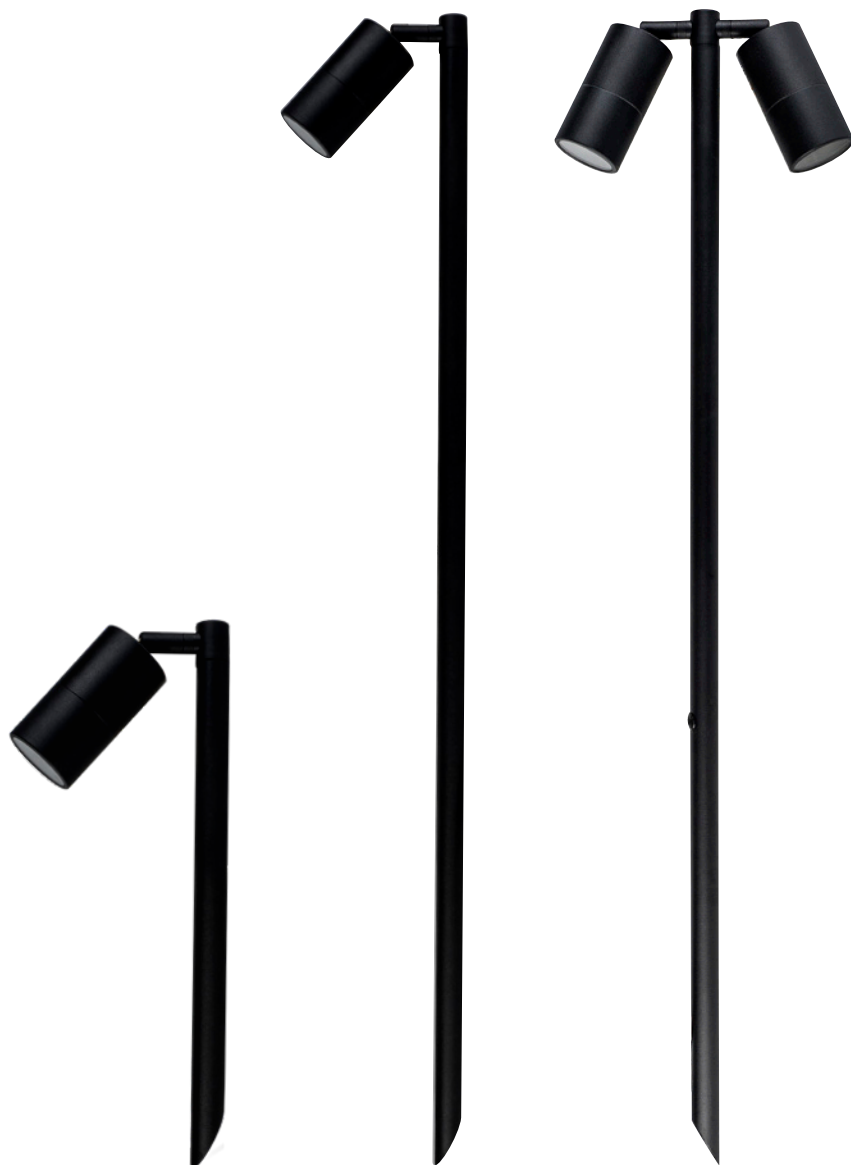

HV1407T-BLK
Single Adjustable

HV1423T
Single Adjustable

HV1425T
Double Adjustable

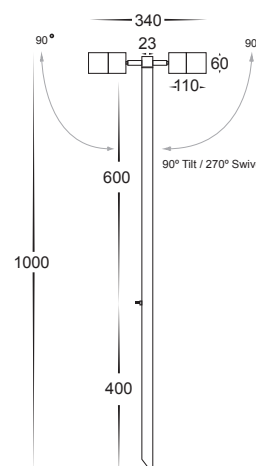
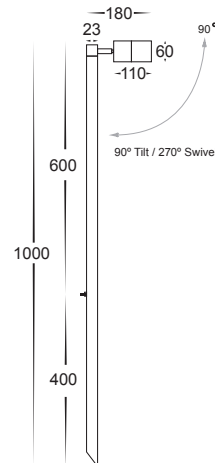
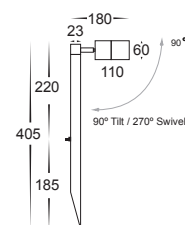

Tivah Aluminium Black

- Adjustable spike spotlight
- Aluminium Poly Powder Coated Black
- Internal cable
- 405mm & 1000mm spike length
- 2m reinforced cable
- IP Rating: IP65

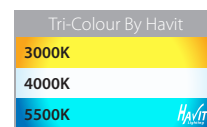

PART NUMBER	COLOUR TEMP	LUMENS	INPUT	INCLUDED LED
HV1423T	3000K - 4000K - 5500K	270lm - 285lm - 300lm	12v DC	Tri-Colour 5w MR16 LED
HV1425T	3000K - 4000K - 5500K	2x 270lm - 2x 285lm - 2x 300lm	12v DC	Tri-Colour 2x 5w MR16 LED
HV1407T-BLK	3000K - 4000K - 5500K	270lm - 285lm - 300lm	12v DC	Tri-Colour 5w MR16 LED
HAVIT COMPATIBLE ACCESSORIES				
HV9507	3000K - 4000K - 5500K	240lm-630lm	12v DC	Tri-Colour 3W/5W/7W MR16 LED
HV9508	3000K - 4000K - 5500K	240lm-630lm	24v DC	Tri-Colour 3W/5W/7W MR16 LED

See pages 295-306 for compatible drivers. All low voltage products that specify an input of 12v or 24v DC must be used with a suitable LED driver.



For detailed product specifications
visit www.Havit.com.au
or scan this QR code



HV1426NW-SS316
316 Stainless Steel

HV1426NW-BLK
Aluminium Black

HV1426NW-AB
Antique Brass

HV1426NW-GPH
Graphite

Tivah Mini Spike

- Single adjustable spike spotlight
- 316 Stainless Steel, Aluminium Poly Powder Coated Black, Solid Brass with Antique Brass or Graphite coloured finish
- Spike Length: 140mm
- 1m reinforced cable
- IP Rating: IP65

i Solid Brass fittings will naturally tarnish. Solid Brass fittings with additional coloured coatings (Antique Brass & Graphite) may tarnish through the coating when installed in outdoor environments.



PART NUMBER	COLOUR TEMP	LUMENS	INPUT	INCLUDED LED
HV1426NW-SS316	3000K + 4000K	270lm - 300lm	12v DC	3w 3000K MR11 LED + 3w 4000K MR11 LED
HV1426NW-BLK	3000K + 4000K	270lm - 300lm	12v DC	3w 3000K MR11 LED + 3w 4000K MR11 LED
HV1426NW-AB	3000K + 4000K	270lm - 300lm	12v DC	3w 3000K MR11 LED + 3w 4000K MR11 LED
HV1426NW-GPH	3000K + 4000K	270lm - 300lm	12v DC	3w 3000K MR11 LED + 3w 4000K MR11 LED

See pages 295-306 for compatible drivers. All low voltage products that specify an input of 12v or 24v DC must be used with a suitable LED driver.



Spitze Aluminium Black

- Single adjustable spike spotlight
- Aluminium Poly Powder Coated Black
- Spike length: 162mm
- 1m reinforced cable
- IP Rating: IP65

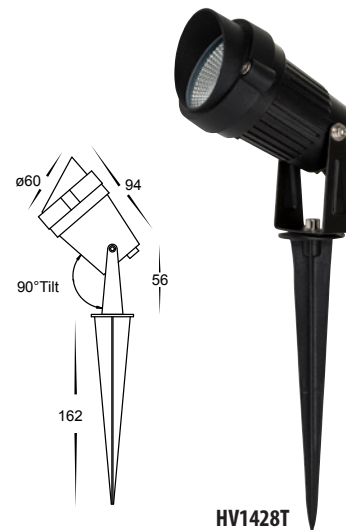
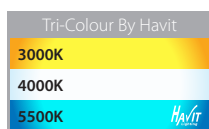

HV1428T

PART NUMBER	COLOUR TEMP	LUMENS	INPUT	INCLUDED LED
HV1428T	3000K - 4000K - 5500K	275lm - 300lm - 320lm	12v DC	Tri-Colour Built-in 3w LED

See pages 295-306 for compatible drivers. All low voltage products that specify an input of 12v or 24v DC must be used with a suitable LED driver.



HV1428RGCW-KIT
HV1428RGCW

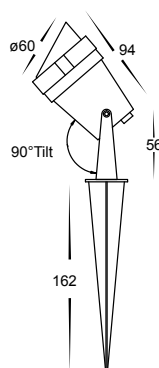

Can be surface mounted

Spitze Aluminium Black

- Single adjustable spike RGBCW spotlight kit
- Aluminium Poly Powder Coated Black
- Spike length: 162mm
- 2m reinforced cable with DIY Plugs
- IP Rating: IP65
- Kit Includes
 - » 5x Spike Lights
 - » 1x LED Driver
 - » 1x WIFI + IR Receiver
 - » 1x IR Remote



PART NUMBER	COLOUR TEMP	LUMENS	INPUT	INCLUDED LED
HV1428RGCW-KIT	RGB + 3000K + 5500K	3000K = 5x 180lm 5500K = 5x 200lm	Driver = 240v AC Fitting = 24v DC	RGCW 5x Built-in 3w LED
HV1428RGCW	RGB + 3000K + 5500K	3000K = 180lm 5500K = 200lm	24v DC	RGCW Built-in 3w LED
HV1428RGCW-REC	N/A	N/A	24v DC	N/A
HV1428RGCW-D	N/A	N/A	240v AC	N/A
HV1428RGCW-EXT	1500mm Extension cable to connect fitting to fitting			
ADDITIONAL 5X LIGHTS CAN BE ADDED TO KIT - 10 LIGHTS IN TOTAL				

See pages 295-306 for compatible drivers. All low voltage products that specify an input of 12v or 24v DC must be used with a suitable LED driver.



For detailed product specifications visit www.Havit.com.au or scan this QR code



Oasis Aluminium Black

- Single adjustable spike spotlight
- Aluminium Poly Powder Coated Black
- Spike length: 260mm
- 1m reinforced cable
- Dimmable
- IP Rating: IP65

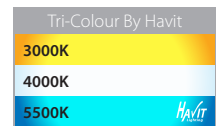

PART NUMBER	COLOUR TEMP	LUMENS	INPUT	INCLUDED LED
HV1429T-7W	3000K - 4000K - 5500K	560lm - 580lm - 595lm	12v DC	Tri-Colour Built-in 7w COB
HV1429T-12W	3000K - 4000K - 5500K	960lm - 1020lm - 1080lm	12v DC	Tri-Colour Built-in 12w COB
HV1429T-24W	3000K - 4000K - 5500K	1900lm - 1970lm - 2040lm	12v DC	Tri-Colour Built-in 24w COB

See pages 295-306 for compatible drivers. All low voltage products that specify an input of 12v or 24v DC must be used with a suitable LED driver.



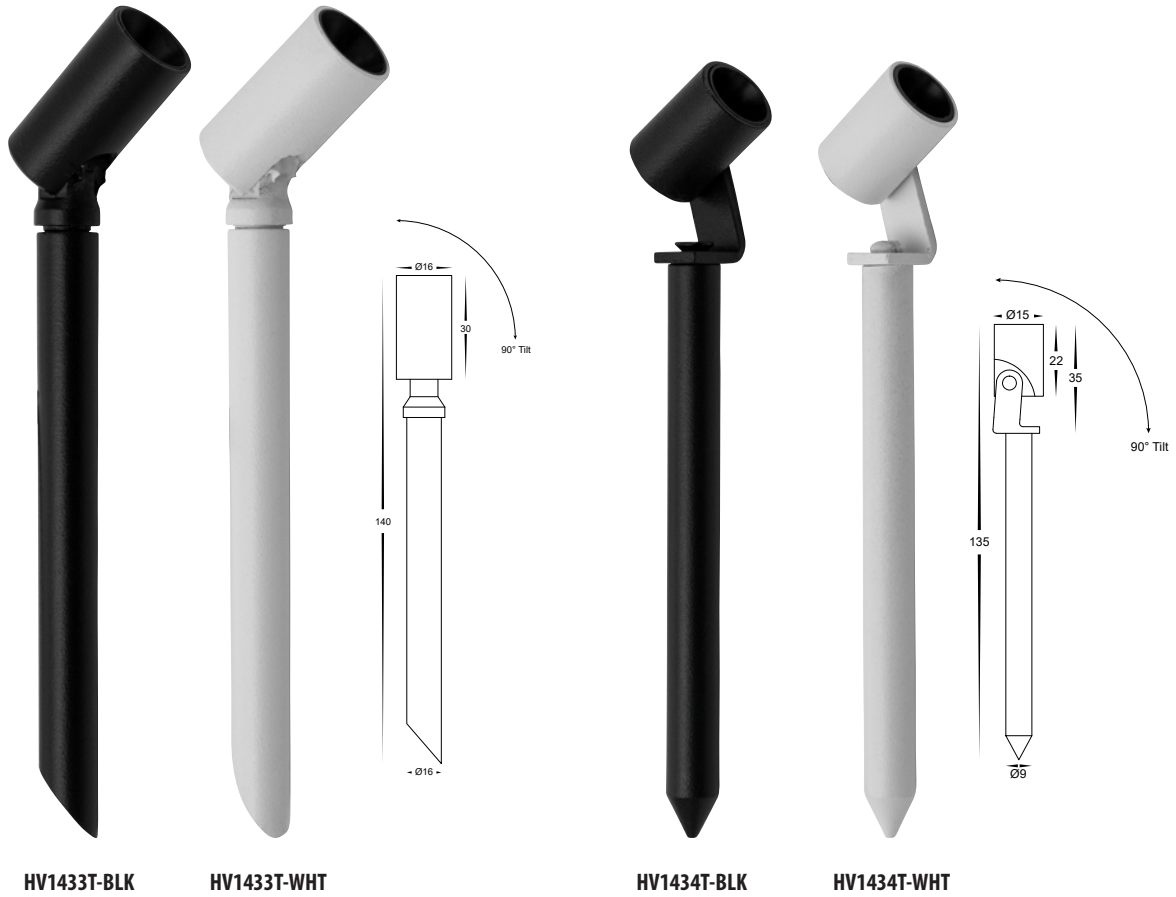

HV1433T-BLK

HV1433T-WHT

HV1434T-BLK

HV1434T-WHT

Spar Aluminium

- Mini Spot Light
- Aluminium Poly Powder Coated Black & White
- Can be use with Spike or Surface Mounted
- IP Rating: IP65

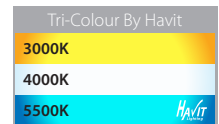

PART NUMBER	COLOUR TEMP	LUMENS	INPUT	INCLUDED LED
HV1433T-BLK	3000K - 4000K - 5500K	25lm - 30lm - 27lm	12v DC	Tri-Colour 0.5w Built in LED
HV1433T-WHT	3000K - 4000K - 5500K	25lm - 30lm - 27lm	12v DC	Tri-Colour 0.5w Built in LED
HV1434T-BLK	3000K - 4000K - 5500K	25lm - 30lm - 27lm	12v DC	Tri-Colour 0.5w Built in LED
HV1434T-WHT	3000K - 4000K - 5500K	25lm - 30lm - 27lm	12v DC	Tri-Colour 0.5w Built in LED

See pages 295-306 for compatible drivers. All low voltage products that specify an input of 12v or 24v DC must be used with a suitable LED driver.



For detailed product specifications
visit www.Havit.com.au
or scan this QR code





HV1435T-AB
Antique Brass

HV1435T-BLK
Brass Black

HV1435T-BR
Solid Brass



HV1435-P-AB

HV1435-P-BLK

HV1435-P-BR

HV145-AB-BASE

HV145-BLK-BASE

HV145-BR-BASE



Assembled Example

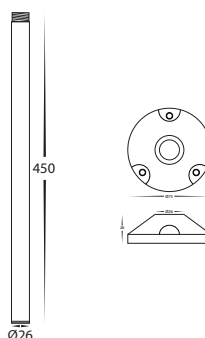
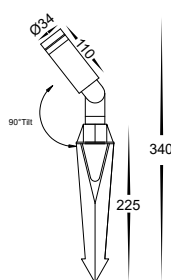

Cilindor

- Single Adjustable Spike Spot Light
- Solid Brass with Antique Brass Finish, Solid Brass Poly Powder Coated Black, Solid Brass
- 225mm Spike
- IP Rating: IP65

i Solid Brass fittings will naturally tarnish. Solid Brass fittings with additional coloured coatings (Antique Brass & Graphite) may tarnish through the coating when installed in outdoor environments.

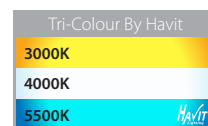

PART NUMBER	COLOUR TEMP	LUMENS	INPUT	INCLUDED LED
HV1435T-AB	3000K - 4000K - 5500K	250lm - 270lm - 265lm	12v DC	Tri Colour Built in 3w LED
HV1435T-BLK	3000K - 4000K - 5500K	250lm - 270lm - 265lm	12v DC	Tri Colour Built in 3w LED
HV1435T-BR	3000K - 4000K - 5500K	250lm - 270lm - 265lm	12v DC	Tri Colour Built in 3w LED
HAVIT COMPATIBLE ACCESSORIES				
HV1435-P-AB	450mm Antique Brass Post to suit HV1435T-AB			
HV1435-P-BLK	450mm Black Post to suit HV1435T-BLK			
HV1435-P-BR	450mm Brass Post to suit HV1435T-BR			
HV145-AB-BASE	Antique Brass Mounting Base			
HV145-BLK-BASE	Black Mounting Base			
HV145-BR-BASE	Brass Mounting Base			

See pages 295-306 for compatible drivers. All low voltage products that specify an input of 12v or 24v DC must be used with a suitable LED driver.



For detailed product specifications visit www.Havit.com.au or scan this QR code



HV1438C
HV1438W



HV1437C
HV1437W

Vidro 316 Stainless Steel

- Garden spike light
- Stainless Steel 316 Marine Grade
- IP Rating: IP44
- Garden spike light 6 pack Kit Includes:
 - » 6x single spike lights
 - » 15m of Cable
 - » 6x 1.5w LED globes
 - » 1x LED driver

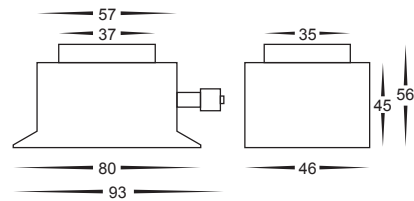
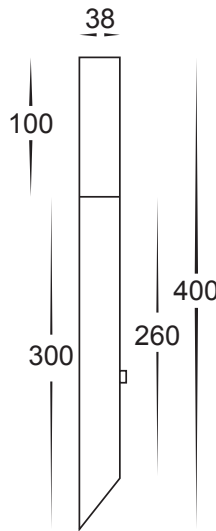

PART NUMBER	COLOUR TEMP	LUMENS	INPUT	INCLUDED LED
HV1437C	5500K	110lm	12v DC	1.5w G4 SMD Bi pin
HV1437W	3000K	90lm	12v DC	1.5w G4 SMD Bi pin
HV1438C	5500K	6x 110lm	Driver = 240v AC - Fitting = 12v DC	6 x 1.5w G4 Bi pin + driver
HV1438W	3000K	6x 90lm	Driver = 240v AC - Fitting = 12v DC	6 x 1.5w G4 Bi pin + driver

See pages 295-306 for compatible drivers. All low voltage products that specify an input of 12v or 24v DC must be used with a suitable LED driver.





HV1441T-BLK

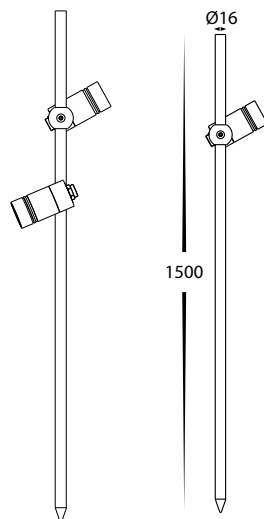
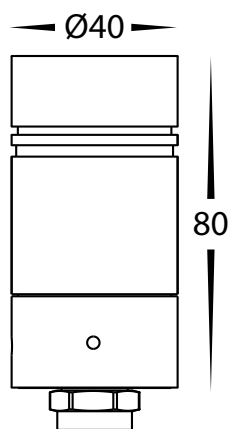

HV1441-HC

HV1441-HOOD

HV1441-L-LENS

HV1441-POST

Lille Aluminium Black

- Garden Spot Light
- Aluminium Poly Powder Coated Black
- To be added to HV1441-POST (2 Heads Maximum)
- Optional Honeycomb Lens & Hooded Cover
- IP Rating: IP65

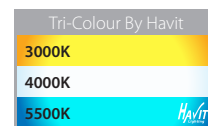

PART NUMBER	COLOUR TEMP	LUMENS	INPUT	INCLUDED LED
HV1441T-BLK	3000K - 4000K - 5500K	130lm - 150lm 140lm	24v DC	Tri-Colour 2.5w Built in LED
HAVIT COMPATIBLE ACCESSORIES				
HV1441-POST	1500mm Post - Max 2 Heads (HV1441T-BLK) can be used on post			
HV1441-HOOD	Antiglare Hood			
HV1441-HC	Honeycomb Lens			
HV1441-L-LENS	Linear Lens			

See pages 295-306 for compatible drivers. All low voltage products that specify an input of 12v or 24v DC must be used with a suitable LED driver.



For detailed product specifications visit www.Havit.com.au or scan this QR code



HV1442T-BLK

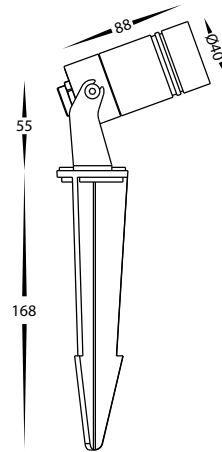

Shown with optional Hooded Cover

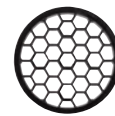

HV1441-HC



HV1441-HOOD



HV1441-L-LENS

Lille Aluminium Black

- Garden Spot Light
- Aluminium Poly Powder Coated Black
- Optional Honeycomb Lens & Hooded Cover
- IP Rating: IP65

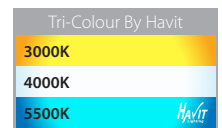

PART NUMBER	COLOUR TEMP	LUMENS	INPUT	INCLUDED LED
HV1442T-BLK	3000K - 4000K - 5500K	130lm - 150lm 140lm	24v DC	Tri-Colour 2.5w Built in LED
HAVIT COMPATIBLE ACCESSORIES				
HV1441-HOOD	Antiglare Hood			
HV1441-HC	Honeycomb Lens			
HV1441-L-LENS	Linear Lens			

See pages 295-306 for compatible drivers. All low voltage products that specify an input of 12v or 24v DC must be used with a suitable LED driver.





HV1451T
Laiton

HV1458T
Shawl

HV1458T-BLK
Shawl

Optional surface mount base available



HV145-AB-BASE



HV145-BLK-BASE

Solid Brass

- Garden lights with spike
- Solid Brass With Antique Brass Finish or Poly Powder Coated Black Finish
- Spike length: 225mm
- 1m reinforced cable
- IP Rating: IP54

i Solid Brass fittings will naturally tarnish. Solid Brass fittings with additional coloured coatings (Antique Brass & Graphite) may tarnish through the coating when installed in outdoor environments.

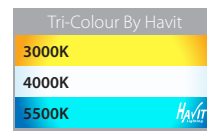

PART NUMBER	COLOUR TEMP	LUMENS	INPUT	INCLUDED LED
HV1451T	3000K - 4000K - 5500K	270lm - 285lm - 300lm	12v DC	Tri-Colour 5w MR16 LED
HV1458T	3000K - 4000K - 5500K	270lm - 285lm - 300lm	12v DC	Tri-Colour 5w MR16 LED
HV1458T-BLK	3000K - 4000K - 5500K	270lm - 285lm - 300lm	12v DC	Tri-Colour 5w MR16 LED
HAVIT COMPATIBLE ACCESSORIES				
HV9507	3000K - 4000K - 5500K	240lm-630lm	12v DC	Tri-Colour 3W/5W/7W MR16 LED
HV9508	3000K - 4000K - 5500K	240lm-630lm	24v DC	Tri-Colour 3W/5W/7W MR16 LED
HV145-AB-BASE	Optional Base to suit: HV1451T, HV1452T, HV1453T & HV1458T			
HV145-BLK-BASE	Optional Base to suit: HV1452T, HV1453T & HV1458T			

See pages 295-306 for compatible drivers. All low voltage products that specify an input of 12v or 24v DC must be used with a suitable LED driver.



For detailed product specifications visit www.Havit.com.au or scan this QR code

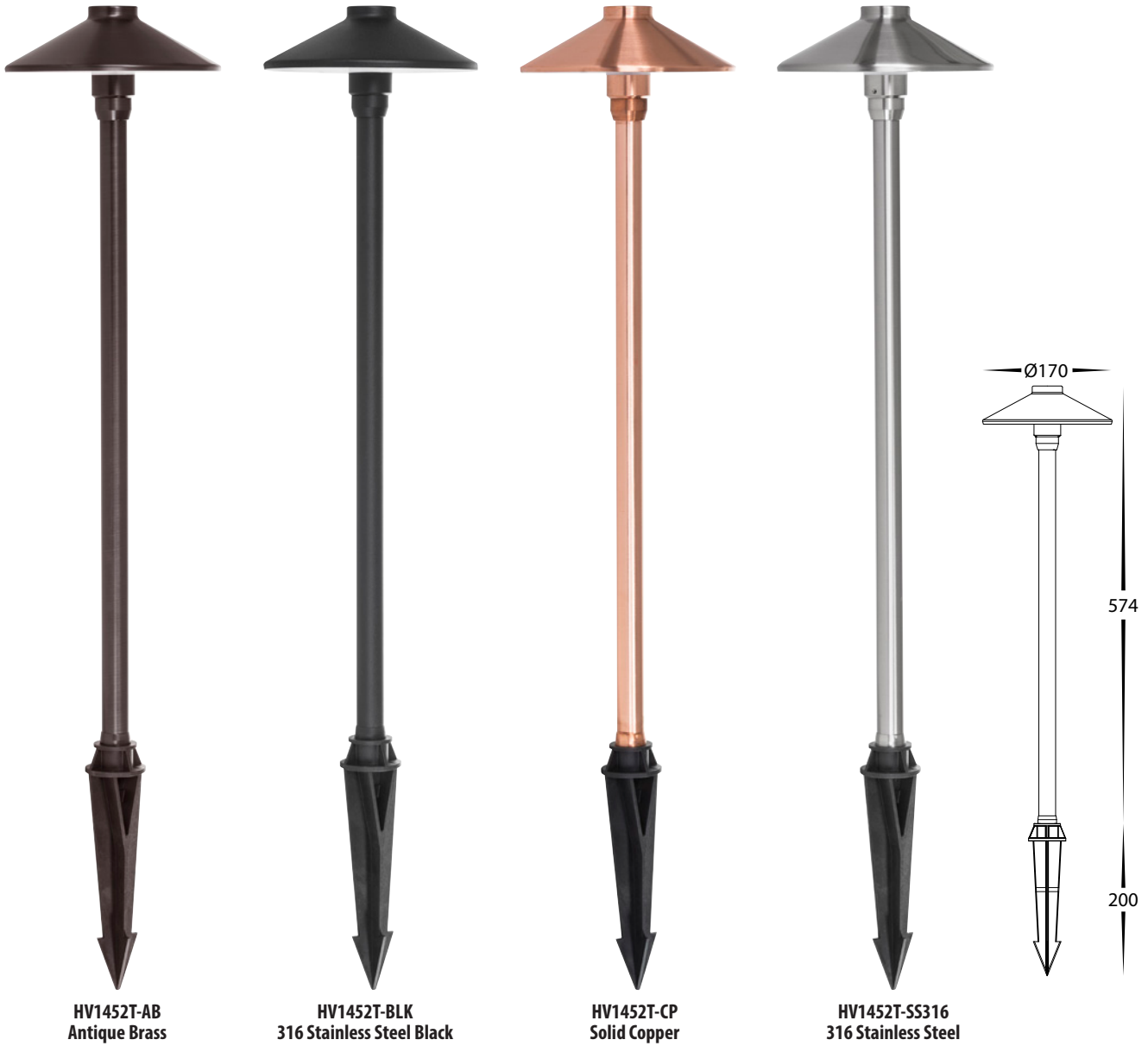

Polari

- Bollard Light with spike
- Solid Brass with Antique Brass Finish, Solid Copper, 316 Stainless Steel and 316 Stainless Steel Black
- 200mm Spike
- IP Rating: IP65

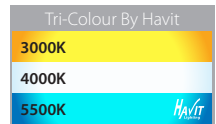

i Solid Brass and Solid Copper fittings will naturally tarnish. Solid Brass fittings with additional coloured coatings (Antique Brass & Graphite) may tarnish through the coating when installed in outdoor environments.

PART NUMBER	COLOUR TEMP	LUMENS	INPUT	INCLUDED LED
HV1452T-AB	3000K - 4000K - 5500K	300lm - 315lm - 310lm	12v DC	Tri Colour 3w LED Bi Pin
HV1452T-BLK	3000K - 4000K - 5500K	300lm - 315lm - 310lm	12v DC	Tri Colour 3w LED Bi Pin
HV1452T-CP	3000K - 4000K - 5500K	300lm - 315lm - 310lm	12v DC	Tri Colour 3w LED Bi Pin
HV1452T-SS316	3000K - 4000K - 5500K	300lm - 315lm - 310lm	12v DC	Tri Colour 3w LED Bi Pin

See pages 295-306 for compatible drivers. All low voltage products that specify an input of 12v or 24v DC must be used with a suitable LED driver.





HV1453T-AB
Antique Brass

HV1453T-BLK
316 Stainless Steel Black

HV1453T-CP
Solid Copper

HV1453T-SS316
316 Stainless Steel

Bitta

- Bollard Light with spike
- Solid Brass with Antique Brass Finish, Solid Copper, 316 Stainless Steel and 316 Stainless Steel Black
- 200mm Spike
- IP Rating: IP65

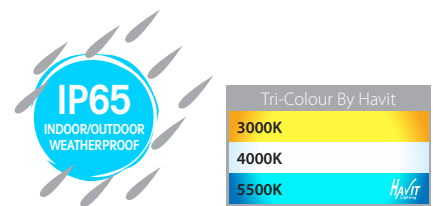

i Solid Brass and Solid Copper fittings will naturally tarnish. Solid Brass fittings with additional coloured coatings (Antique Brass & Graphite) may tarnish through the coating when installed in outdoor environments.

PART NUMBER	COLOUR TEMP	LUMENS	INPUT	INCLUDED LED
HV1453T-AB	3000K - 4000K - 5500K	300lm - 315lm - 310lm	12v DC	Tri Colour 3w LED Bi Pin
HV1453T-BLK	3000K - 4000K - 5500K	300lm - 315lm - 310lm	12v DC	Tri Colour 3w LED Bi Pin
HV1453T-CP	3000K - 4000K - 5500K	300lm - 315lm - 310lm	12v DC	Tri Colour 3w LED Bi Pin
HV1453T-SS316	3000K - 4000K - 5500K	300lm - 315lm - 310lm	12v DC	Tri Colour 3w LED Bi Pin

See pages 295-306 for compatible drivers. All low voltage products that specify an input of 12v or 24v DC must be used with a suitable LED driver.



For detailed product specifications
visit www.Havit.com.au
or scan this QR code

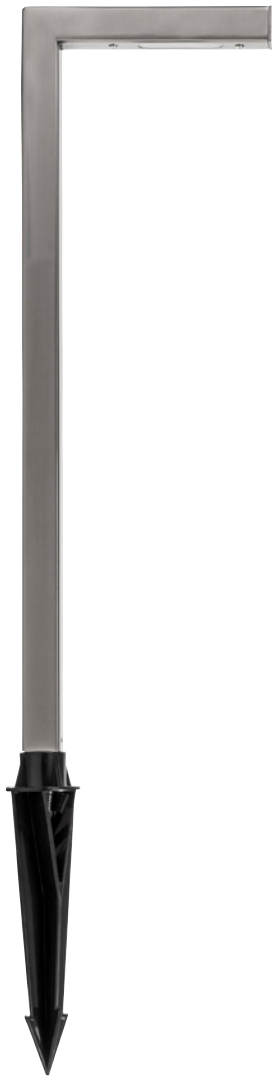

HV1459T-SS316
316 Stainless Steel



HV1459T-AB
Antique Brass



HV1459T-BLK
Black Aluminium

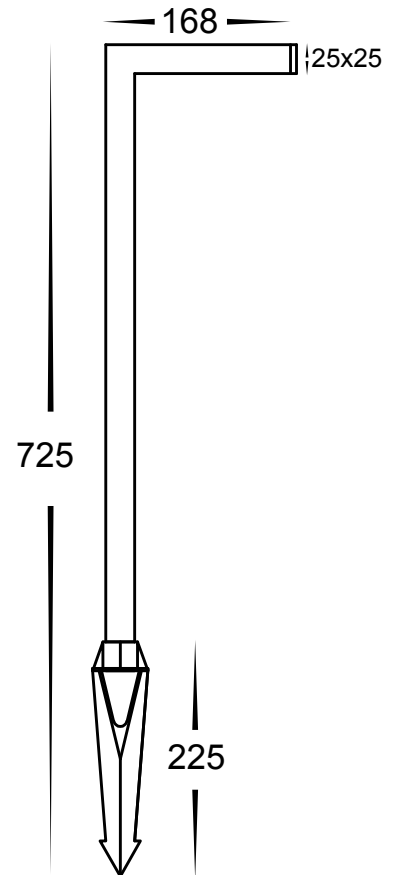

Nedia

- Bollard Spike Light
- 316 Stainless Steel, Antique Brass and Aluminium Black
- Spike Length: 225mm
- 1m Reinforced cable
- IP Rating: IP54

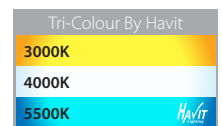

i Solid Brass fittings will naturally tarnish. Solid Brass fittings with additional coloured coatings (Antique Brass & Graphite) may tarnish through the coating when installed in outdoor environments.

PART NUMBER	COLOUR TEMP	LUMENS	INPUT	INCLUDED LED
HV1459T-SS316	3000K - 4000K - 5500K	500lm - 525lm - 550lm	12v DC	Tri-Colour Built-in 7w LED
HV1459T-AB	3000K - 4000K - 5500K	500lm - 525lm - 550lm	12v DC	Tri-Colour Built-in 7w LED
HV1459T-BLK	3000K - 4000K - 5500K	500lm - 525lm - 550lm	12v DC	Tri-Colour Built-in 7w LED

See pages 295-306 for compatible drivers. All low voltage products that specify an input of 12v or 24v DC must be used with a suitable LED driver.





HV1462T-BLK
HV1462RGCW-BLK
Black Aluminium



HV1462T-SS316
HV1462RGCW-SS316
316 Stainless Steel

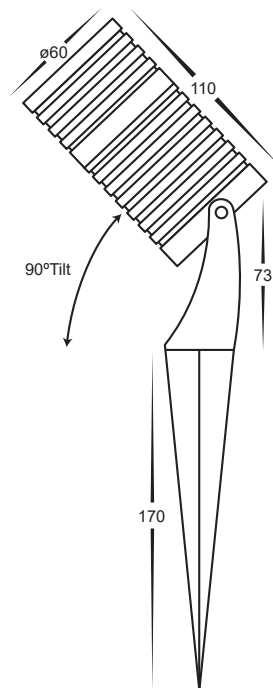

Nova

- Single adjustable spike spotlight
- 316 Stainless Steel and Aluminium Poly Powder Coated Black
- Spike length: 170mm
- 1m reinforced cable
- IP Rating: IP65

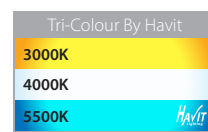

PART NUMBER	COLOUR TEMP	LUMENS	INPUT	INCLUDED LED
HV1462T-SS316	3000K - 4000K - 5500K	270lm - 285lm - 300lm	12v DC	Tri-Colour 5w MR16 LED
HV1462RGCW-SS316	RGB + 3000K + 5500K	200lm (3000K)	12v DC	RGCW Built-in 7w LED
HV1462T-BLK	3000K - 4000K - 5500K	240lm - 250lm - 360lm	12v DC	Tri-Colour 5w MR16 LED
HV1462RGCW-BLK	RGB + 3000K + 5500K	200lm (3000K)	12v DC	RGCW Built-in 7w LED

HAVIT COMPATIBLE ACCESSORIES

HV9507	3000K - 4000K - 5500K	240lm-630lm	12v DC	Tri-Colour 3W/5W/7W MR16 LED
HV9508	3000K - 4000K - 5500K	240lm-630lm	24v DC	Tri-Colour 3W/5W/7W MR16 LED

See pages 295-306 for compatible drivers. All low voltage products that specify an input of 12v or 24v DC must be used with a suitable LED driver.

RGCW Models can be used with any RGCW Controller in LED Controller section of this catalogue.



For detailed product specifications visit www.Havit.com.au or scan this QR code

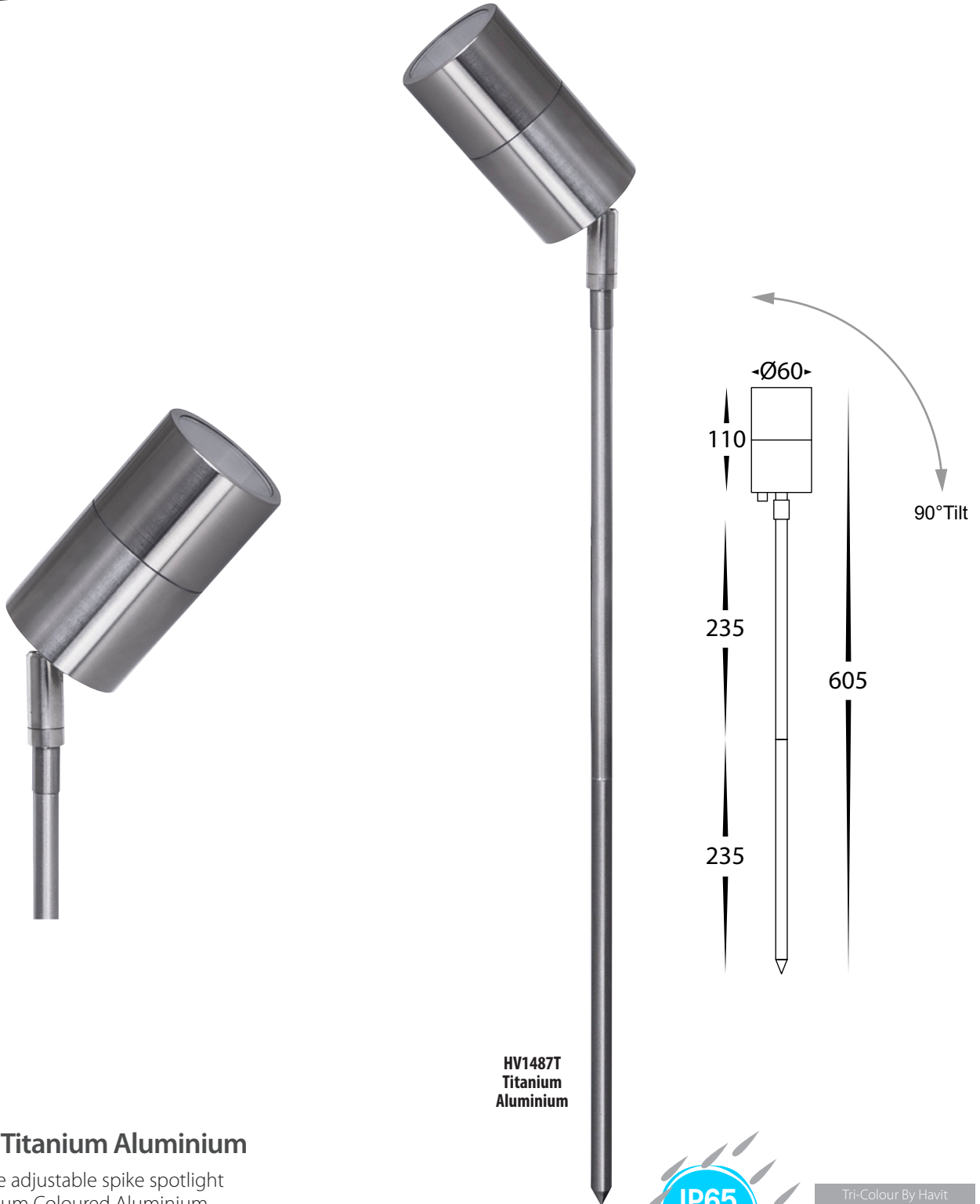

HV1487T
Titanium
Aluminium

Tivah Titanium Aluminium

- Single adjustable spike spotlight
- Titanium Coloured Aluminium
- Spike length: 2 x 235mm (total 470mm)
- 2m reinforced cable
- IP Rating: IP65

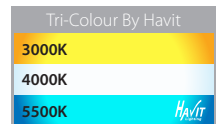

PART NUMBER	COLOUR TEMP	LUMENS	INPUT	INCLUDED LED
HV1487T	3000K - 4000K - 5500K	270lm - 285lm - 300lm	12v DC	Tri-Colour 5w MR16 LED
HAVIT COMPATIBLE ACCESSORIES				
HV9507	3000K - 4000K - 5500K	240lm-630lm	12v DC	Tri-Colour 3W/5W/7W MR16 LED
HV9508	3000K - 4000K - 5500K	240lm-630lm	24v DC	Tri-Colour 3W/5W/7W MR16 LED

See pages 295-306 for compatible drivers. All low voltage products that specify an input of 12v or 24v DC must be used with a suitable LED driver.





HV1457T
Solid Brass

HV1477T
Graphite

HV1497T
Antique Brass

Tivah Solid Brass

- Single adjustable spike light
- Solid Brass, and Solid Brass with Antique Brass or Graphite coloured finish
- Spike Length: 235mm
- 2m reinforced cable
- IP Rating: IP65



i Solid Brass fittings will naturally tarnish. Solid Brass fittings with additional coloured coatings (Antique Brass & Graphite) may tarnish through the coating when installed in outdoor environments.

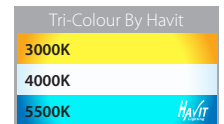

PART NUMBER	COLOUR TEMP	LUMENS	INPUT	INCLUDED LED
HV1457T	3000K - 4000K - 5500K	270lm - 285lm - 300lm	12v DC	Tri-Colour 5w MR16 LED
HV1477T	3000K - 4000K - 5500K	270lm - 285lm - 300lm	12v DC	Tri-Colour 5w MR16 LED
HV1497T	3000K - 4000K - 5500K	240lm - 250lm - 360lm	12v DC	Tri-Colour 5w MR16 LED
HAVIT COMPATIBLE ACCESSORIES				
HV9507	3000K - 4000K - 5500K	240lm-630lm	12v DC	Tri-Colour 3W/5W/7W MR16 LED
HV9508	3000K - 4000K - 5500K	240lm-630lm	24v DC	Tri-Colour 3W/5W/7W MR16 LED

See pages 295-306 for compatible drivers. All low voltage products that specify an input of 12v or 24v DC must be used with a suitable LED driver.



For detailed product specifications visit www.Havit.com.au or scan this QR code

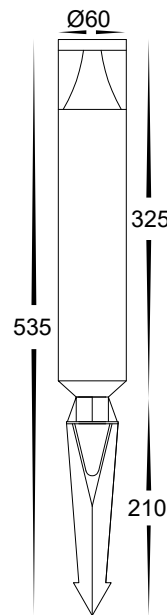

HV1488T-BLK

Divad Aluminium Black

- Garden Spike Light
- Aluminium Poly Powder Coated Black
- 210mm Spike Length
- IP Rating: IP65

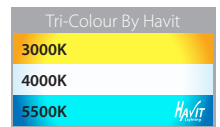

PART NUMBER	COLOUR TEMP	LUMENS	INPUT	INCLUDED LED
HV1488T-BLK	3000K - 4000K - 5500K	300lm - 320lm - 310lm	12v DC	Tri-Colour 5w Built in LED

See pages 295-306 for compatible drivers. All low voltage products that specify an input of 12v or 24v DC must be used with a suitable LED driver.



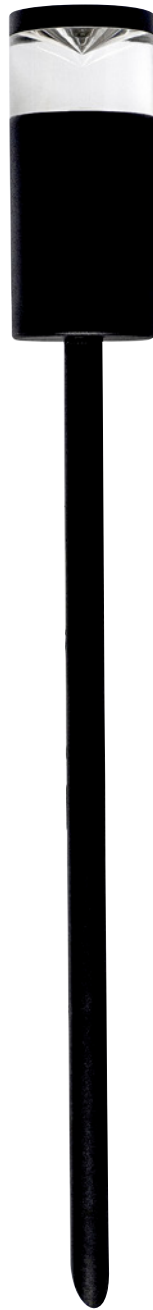

HV1489T-BLK
Black Aluminium



HV1489T-TTM
Titanium Aluminium

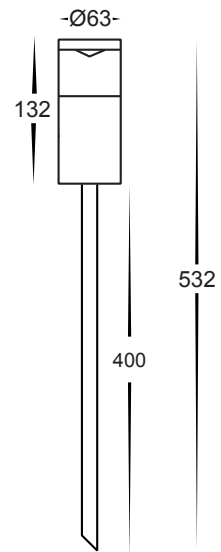

Highlite Aluminium

- Single fixed spike light
- Titanium Coloured Aluminium and Aluminium Poly Powder Coated Black
- High grade perspex reflector lens
- 2m reinforced cable
- Spike length: 400mm
- IP Rating: IP65

Suitable for use with LED globes only

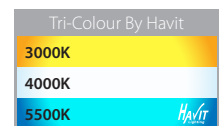

PART NUMBER	COLOUR TEMP	LUMENS	INPUT	INCLUDED LED
HV1489T-BLK	3000K - 4000K - 5500K	270lm - 285lm - 300lm	12v DC	Tri-Colour 5w MR16 LED
HV1489T-TTM	3000K - 4000K - 5500K	270lm - 285lm - 300lm	12v DC	Tri-Colour 5w MR16 LED
HAVIT COMPATIBLE ACCESSORIES				
HV9507	3000K - 4000K - 5500K	240lm-630lm	12v DC	Tri-Colour 3W/5W/7W MR16 LED
HV9508	3000K - 4000K - 5500K	240lm-630lm	24v DC	Tri-Colour 3W/5W/7W MR16 LED

See pages 295-306 for compatible drivers. All low voltage products that specify an input of 12v or 24v DC must be used with a suitable LED driver.



For detailed product specifications
visit www.Havit.com.au
or scan this QR code



**HV1491T
HV1491RGBW
316 STAINLESS STEEL**



**HV1491T-BR
SOLID BRASS**



HV1491T

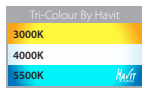

HV1491RGBW

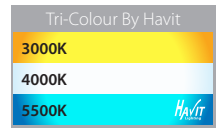
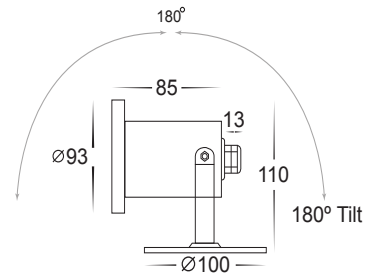
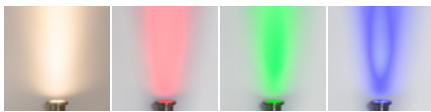

Onder 316 Stainless Steel

- Submersible pond light
- Stainless Steel 316 Marine Grade or Solid Brass
- HV1491RGBW Must be used with a suitable RGBW Controller
- 6 metre cable
- IP Rating: IP68

i Solid Brass fittings will naturally tarnish. Solid Brass fittings with additional coloured coatings (Antique Brass & Graphite) may tarnish through the coating when installed in outdoor environments.

PART NUMBER	COLOUR TEMP	LUMENS	INPUT	INCLUDED LED
HV1491T	3000K - 4000K - 5500K	270lm - 285lm - 300lm	12v DC	Tri-Colour 5w MR16 LED
HV1491T-BR	3000K - 4000K - 5500K	270lm - 285lm - 300lm	12v DC	Tri-Colour 5w MR16 LED
HV1491RGBW	RGBW	275lm (3000K)	12v DC	RGBW Built-in 5w LED
HAVIT COMPATIBLE ACCESSORIES				
HV9507	3000K - 4000K - 5500K	240lm-630lm	12v DC	Tri-Colour 3W/5W/7W MR16 LED
HV9508	3000K - 4000K - 5500K	240lm-630lm	24v DC	Tri-Colour 3W/5W/7W MR16 LED
HV350-SPK	Optional Garden Spike to suit HV1494 Models			
See pages 295-306 for compatible drivers. All low voltage products that specify an input of 12v or 24v DC must be used with a suitable LED driver.				
RGBW Models can be used with suitable Controllers in the LED Controller section of this catalogue				





**HV1494T
HV1494RGB**



HV1494-REM



HV350-SPK

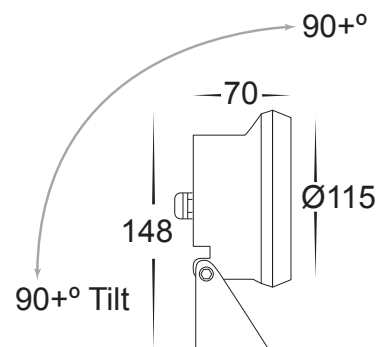

Sotto 316 Stainless Steel

- Submersible pond light or garden light
- Stainless Steel 316 Marine Grade
- HV1494RGB must use suitable Havit RGB control gear
- 6 metre cable
- IP Rating: IP68

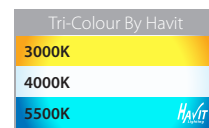
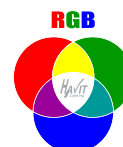

PART NUMBER	COLOUR TEMP	LUMENS	INPUT	INCLUDED LED
HV1494T	3000K - 4000K - 5500K	870lm - 950lm - 920lm	12v DC	Tri-Colour Built-in 15w LED
HV1494RGB	RGB	500lm	12v DC	RGB Built-in 15w LED
HV1494-REM	RGB	NA	12v DC	Remote and Receiver

HAVIT COMPATIBLE ACCESSORIES

HV350-SPK	Optional Garden Spike to suit HV1494 Models
------------------	---

See pages 295-306 for compatible drivers. All low voltage products that specify an input of 12v or 24v DC must be used with a suitable LED driver.

RGB Models can be used with suitable Controllers in the LED Controller section of this catalogue



For detailed product specifications
visit www.Havit.com.au
or scan this QR code



HV1507T-BLK-240V
HV1507T-BLK-12V
Black Aluminium

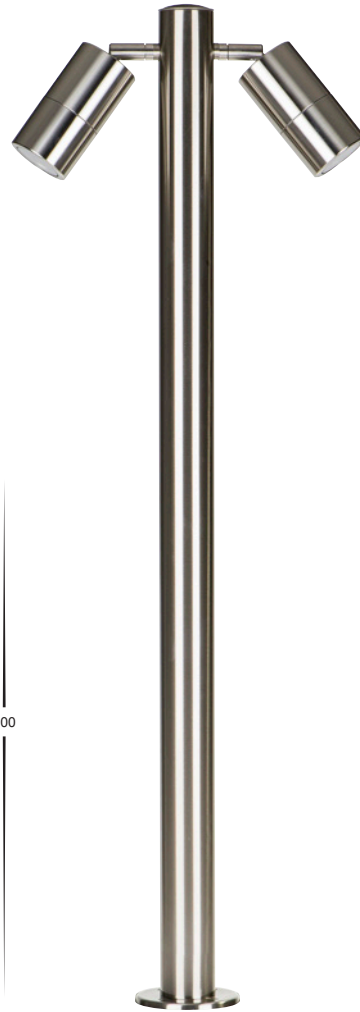
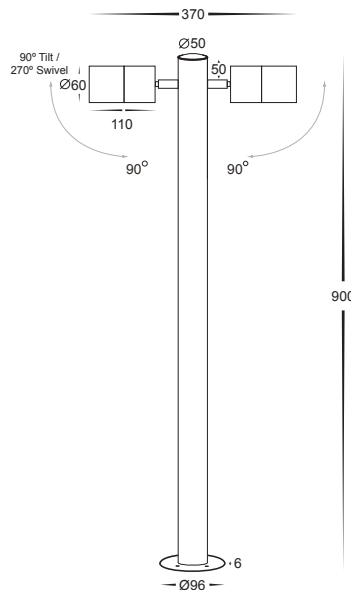

HV1507T-SS316-240V
HV1507T-SS316-12V
316 Stainless Steel

Tivah

- Double adjustable bollard spotlight
- Stainless Steel 316 Marine Grade and Aluminium Poly Powder Coated Black
- IP Rating: IP65

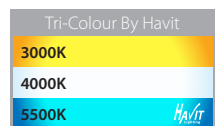

PART NUMBER	COLOUR TEMP	LUMENS	INPUT	INCLUDED LED
HV1507T-SS316-240V	3000K - 4000K - 5500K	2x 270lm - 2x 285lm - 2x 300lm	240v	Tri-Colour 2x 5w GU10 LED
HV1507T-SS316-12V	3000K - 4000K - 5500K	2x 270lm - 2x 285lm - 2x 300lm	12v DC	Tri-Colour 2x 5w MR16 LED
HV1507T-BLK-240V	3000K - 4000K - 5500K	2x 270lm - 2x 285lm - 2x 300lm	240v	Tri-Colour 2x 5w GU10 LED
HV1507T-BLK-12V	3000K - 4000K - 5500K	2x 270lm - 2x 285lm - 2x 300lm	12v DC	Tri-Colour 2x 5w MR16 LED
HAVIT COMPATIBLE ACCESSORIES				
HV9507	3000K - 4000K - 5500K	240lm-630lm	12v DC	Tri-Colour 3W/5W/7W MR16 LED
HV9508	3000K - 4000K - 5500K	240lm-630lm	24v DC	Tri-Colour 3W/5W/7W MR16 LED
HV9506D	3000K - 4000K - 5500K	240lm-630lm	240v	Tri-Colour 3W/5W/7W GU10 LED
HV1607	Bollard spike, High grade stainless steel, 400mm Length, Includes stainless steel base plate			

See pages 295-306 for compatible drivers. All low voltage products that specify an input of 12v or 24v DC must be used with a suitable LED driver.





HV1601T-SS316
HV1602T-SS316
316 Stainless Steel



HV1601T-BLK
HV1602T-BLK
Black Aluminium



HV1601T-WHT
HV1602T-WHT
White Aluminium



HV1601T-TTM
HV1602T-TTM
Titanium Aluminium



HV1601T-AB
HV1602T-AB
Antique Brass

Highlite

- LED bollard light
- High grade perspex reflector lens
- 2m reinforced cable
- 445mm height
- Raised lamp height to maximise light output
- IP Rating: IP54
- To be used with LED globes only

i Solid Brass and Solid Copper fittings will naturally tarnish. Solid Brass fittings with additional coloured coatings (Antique Brass & Graphite) may tarnish through the coating when installed in outdoor environments.

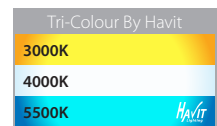

PART NUMBER	COLOUR TEMP	LUMENS	INPUT	INCLUDED LED
HV1601T-SS316	3000K - 4000K - 5500K	270lm - 285lm - 300lm	240v	Tri-Colour 5w GU10 LED
HV1602T-SS316	3000K - 4000K - 5500K	270lm - 285lm - 300lm	12v DC	Tri-Colour 5w MR16 LED
HV1601T-BLK	3000K - 4000K - 5500K	270lm - 285lm - 300lm	240v	Tri-Colour 5w GU10 LED
HV1602T-BLK	3000K - 4000K - 5500K	270lm - 285lm - 300lm	12v DC	Tri-Colour 5w MR16 LED
HV1601T-WHT	3000K - 4000K - 5500K	270lm - 285lm - 300lm	240v	Tri-Colour 5w GU10 LED
HV1602T-WHT	3000K - 4000K - 5500K	270lm - 285lm - 300lm	12v DC	Tri-Colour 5w MR16 LED
HV1601T-TTM	3000K - 4000K - 5500K	270lm - 285lm - 300lm	240v	Tri-Colour 5w GU10 LED
HV1602T-TTM	3000K - 4000K - 5500K	270lm - 285lm - 300lm	12v DC	Tri-Colour 5w MR16 LED
HV1601T-AB	3000K - 4000K - 5500K	270lm - 285lm - 300lm	240v	Tri-Colour 5w GU10 LED
HV1602T-AB	3000K - 4000K - 5500K	270lm - 285lm - 300lm	12v DC	Tri-Colour 5w MR16 LED
HAVIT COMPATIBLE ACCESSORIES				
HV9507	3000K - 4000K - 5500K	240lm-630lm	12v DC	Tri-Colour 3W/5W/7W MR16 LED
HV9508	3000K - 4000K - 5500K	240lm-630lm	24v DC	Tri-Colour 3W/5W/7W MR16 LED
HV9506D	3000K - 4000K - 5500K	240lm-630lm	240v	Tri-Colour 3W/5W/7W GU10 LED
HV1603-SS316		Highlite bollard extension 380mm total extension height IP Rating: As per fitting used Up to 2 extensions can be used		
HV1603-BLK				
HV1603-AB				
HV1603-WHT				
HV1607	Bollard spike, High grade stainless steel, 400mm Length, Includes stainless steel base plate			

See pages 295-306 for compatible drivers. All low voltage products that specify an input of 12v or 24v DC must be used with a suitable LED driver.



For detailed product specifications
visit www.Havit.com.au
or scan this QR code

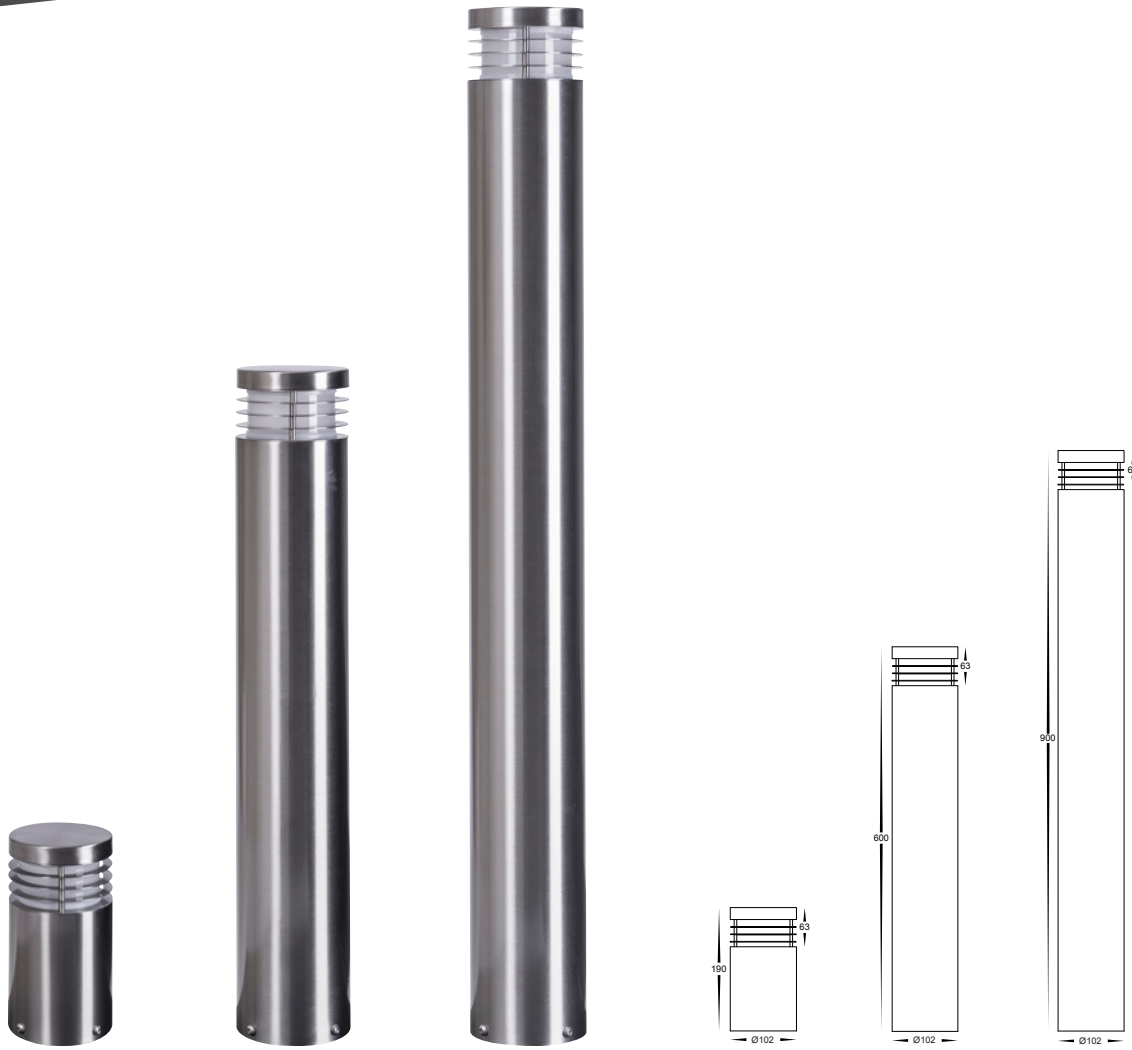

HV1605T-SS316-240V
HV1605T-SS316-12V
Mini

HV1606T-SS316-240V
HV1606T-SS316-12V
Maxi 600

HV1608T-SS316-240V
HV1608T-SS316-12V
Maxi 900

Mini & Maxi 316 Stainless Steel

- Stainless Steel 316 Marine Grade
- Frosted diffuser
- 190mm, 600mm & 900mm height
- IP Rating: IP54
- IK Rating: IK08

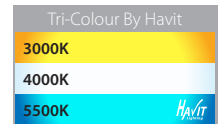

PART NUMBER	COLOUR TEMP	LUMENS	INPUT	INCLUDED LED
HV1605T-SS316-240V	3000K - 4000K - 5500K	700lm - 720lm - 740lm	240v	Tri-Colour 9w E27 LED
HV1605T-SS316-12V	3000K - 4000K - 5500K	270lm - 285lm - 300lm	12v DC	Tri-Colour 5w MR16 LED
HV1606T-SS316-240V	3000K - 4000K - 5500K	700lm - 720lm - 740lm	240v	Tri-Colour 9w E27 LED
HV1606T-SS316-12V	3000K - 4000K - 5500K	270lm - 285lm - 300lm	12v DC	Tri-Colour 5w MR16 LED
HV1608T-SS316-240V	3000K - 4000K - 5500K	700lm - 720lm - 740lm	240v	Tri-Colour 9w E27 LED
HV1608T-SS316-12V	3000K - 4000K - 5500K	270lm - 285lm - 300lm	12v DC	Tri-Colour 5w MR16 LED
HAVIT COMPATIBLE ACCESSORIES				
HV9507	3000K - 4000K - 5500K	240lm-630lm	12v DC	Tri-Colour 3W/5W/7W MR16 LED
HV9508	3000K - 4000K - 5500K	240lm-630lm	24v DC	Tri-Colour 3W/5W/7W MR16 LED
HV1607	Bollard spike, High grade stainless steel, 400mm Length, Includes stainless steel base plate			

See pages 295-306 for compatible drivers. All low voltage products that specify an input of 12v or 24v DC must be used with a suitable LED driver.





HV1605T-BLK-240V
HV1605T-BLK-12V
Mini

HV1606T-BLK-240V
HV1606T-BLK-12V
Maxi 600

HV1608T-BLK-240V
HV1608T-BLK-12V
Maxi 900

Mini & Maxi Stainless Steel Black

- Stainless Steel Poly Powder Coated Black
- Frosted diffuser
- 190mm, 600mm & 900mm height
- IP Rating: IP54
- IK Rating: IK08

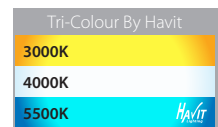

PART NUMBER	COLOUR TEMP	LUMENS	INPUT	INCLUDED LED
HV1605T-BLK-240V	3000K - 4000K - 5500K	700lm - 720lm - 740lm	240v	Tri-Colour 9w E27 LED
HV1605T-BLK-12V	3000K - 4000K - 5500K	270lm - 285lm - 300lm	12v DC	Tri-Colour 5w MR16 LED
HV1606T-BLK-240V	3000K - 4000K - 5500K	700lm - 720lm - 740lm	240v	Tri-Colour 9w E27 LED
HV1606T-BLK-12V	3000K - 4000K - 5500K	270lm - 285lm - 300lm	12v DC	Tri-Colour 5w MR16 LED
HV1608T-BLK-240V	3000K - 4000K - 5500K	700lm - 720lm - 740lm	240v	Tri-Colour 9w E27 LED
HV1608T-BLK-12V	3000K - 4000K - 5500K	270lm - 285lm - 300lm	12v DC	Tri-Colour 5w MR16 LED
HAVIT COMPATIBLE ACCESSORIES				
HV9507	3000K - 4000K - 5500K	240lm-630lm	12v DC	Tri-Colour 3W/5W/7W MR16 LED
HV9508	3000K - 4000K - 5500K	240lm-630lm	24v DC	Tri-Colour 3W/5W/7W MR16 LED
HV1607	Bollard spike, High grade stainless steel, 400mm Length, Includes stainless steel base plate			

See pages 295-306 for compatible drivers. All low voltage products that specify an input of 12v or 24v DC must be used with a suitable LED driver.



For detailed product specifications
visit www.Havit.com.au
or scan this QR code



HV1615T-SS316-240V
HV1615T-SS316-12V
Mini Louvre

HV1616T-SS316-240V
HV1616T-SS316-12V
Maxi Louvre 600

HV1618T-SS316-240V
HV1618T-SS316-12V
Maxi Louvre 900

Mini & Maxi Louvre 316 Stainless Steel

- Stainless Steel 316 Marine Grade
- Clear diffuser with louvres
- 190mm, 600mm & 900mm height
- IP Rating: IP54
- IK Rating: IK08

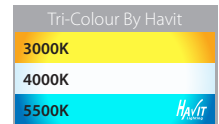

PART NUMBER	COLOUR TEMP	LUMENS	INPUT	INCLUDED LED
HV1615T-SS316-240V	3000K - 4000K - 5500K	700lm - 720lm - 740lm	240v	Tri-Colour 9w E27 LED
HV1615T-SS316-12V	3000K - 4000K - 5500K	270lm - 285lm - 300lm	12v DC	Tri-Colour 5w MR16 LED
HV1616T-SS316-240V	3000K - 4000K - 5500K	700lm - 720lm - 740lm	240v	Tri-Colour 9w E27 LED
HV1616T-SS316-12V	3000K - 4000K - 5500K	270lm - 285lm - 300lm	12v DC	Tri-Colour 5w MR16 LED
HV1618T-SS316-240V	3000K - 4000K - 5500K	700lm - 720lm - 740lm	240v	Tri-Colour 9w E27 LED
HV1618T-SS316-12V	3000K - 4000K - 5500K	270lm - 285lm - 300lm	12v DC	Tri-Colour 5w MR16 LED
HAVIT COMPATIBLE ACCESSORIES				
HV9507	3000K - 4000K - 5500K	240lm-630lm	12v DC	Tri-Colour 3W/5W/7W MR16 LED
HV9508	3000K - 4000K - 5500K	240lm-630lm	24v DC	Tri-Colour 3W/5W/7W MR16 LED
HV1607	Bollard spike, High grade stainless steel, 400mm Length, Includes stainless steel base plate			

See pages 295-306 for compatible drivers. All low voltage products that specify an input of 12v or 24v DC must be used with a suitable LED driver.





HV1615T-BLK-240V
HV1615T-BLK-12V
Mini Louvre

HV1616T-BLK-240V
HV1616T-BLK-12V
Maxi Louvre 600

HV1618T-BLK-240V
HV1618T-BLK-12V
Maxi Louvre 900

Mini & Maxi Louvre Stainless Steel Black

- Stainless Steel Poly Powder Coated Black
- Clear diffuser with louvres
- 190mm, 600mm & 900mm height
- IP Rating: IP54
- IK Rating: IK08

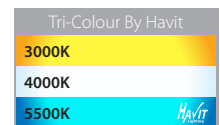

PART NUMBER	COLOUR TEMP	LUMENS	INPUT	INCLUDED LED
HV1615T-BLK-240V	3000K - 4000K - 5500K	700lm - 720lm - 740lm	240v	Tri-Colour 9w E27 LED
HV1615T-BLK-12V	3000K - 4000K - 5500K	270lm - 285lm - 300lm	12v DC	Tri-Colour 5w MR16 LED
HV1616T-BLK-240V	3000K - 4000K - 5500K	700lm - 720lm - 740lm	240v	Tri-Colour 9w E27 LED
HV1616T-BLK-12V	3000K - 4000K - 5500K	270lm - 285lm - 300lm	12v DC	Tri-Colour 5w MR16 LED
HV1618T-BLK-240V	3000K - 4000K - 5500K	700lm - 720lm - 740lm	240v	Tri-Colour 9w E27 LED
HV1618T-BLK-12V	3000K - 4000K - 5500K	270lm - 285lm - 300lm	12v DC	Tri-Colour 5w MR16 LED
HAVIT COMPATIBLE ACCESSORIES				
HV9507	3000K - 4000K - 5500K	240lm-630lm	12v DC	Tri-Colour 3W/5W/7W MR16 LED
HV9508	3000K - 4000K - 5500K	240lm-630lm	24v DC	Tri-Colour 3W/5W/7W MR16 LED
HV1607	Bollard spike, High grade stainless steel, 400mm Length, Includes stainless steel base plate			

See pages 295-306 for compatible drivers. All low voltage products that specify an input of 12v or 24v DC must be used with a suitable LED driver.



For detailed product specifications
visit www.Havit.com.au
or scan this QR code



HV1622T-BLK-240V
HV1622T-BLK-12V

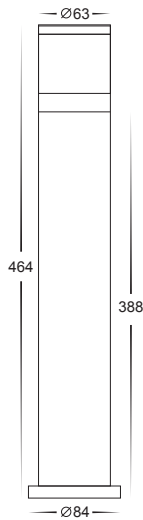

*Shown With
Optional Extension*

HV1622-BLK-EXT

Highlite Aluminium Black

- LED Bollard light
- Aluminium Poly Powder Coated Black
- Opal Polycarbonate Lens
- 464mm Height
- IP Rating: IP65
- IK Rating: IK08

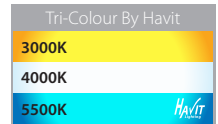

PART NUMBER	COLOUR TEMP	LUMENS	INPUT	INCLUDED LED
HV1622T-BLK-240V	3000K - 4000K - 5500K	860lm - 915lm - 970lm	240v	Tri-Colour Built-in 12w SMD
HV1622T-BLK-12V	3000K - 4000K - 5500K	860lm - 915lm - 970lm	12v DC	Tri-Colour Built-in 12w SMD
HAVIT COMPATIBLE ACCESSORIES				
HV1622-BLK-EXT	Bollard light extension, Aluminium Poly Powder coated black, 380mm Height, IP Rating: as per HV1622-BLK, Up to 2 extensions can be used			
HV1607	Bollard spike, High grade stainless steel, 400mm Length, Includes stainless steel base plate			

See pages 295-306 for compatible drivers. All low voltage products that specify an input of 12v or 24v DC must be used with a suitable LED driver.





HV1625T-BLK-240V
HV1625T-BLK-24V

HV1626T-BLK-240V
HV1626T-BLK-24V

Highlite Aluminium Black

- LED Bollard light
- Aluminium Poly Powder Coated Black
- High grade perspex lens
- 600mm and 1000mm height
- Selectable wattage - 18w or 24w
- IP Rating: IP65
- IK Rating: IK08

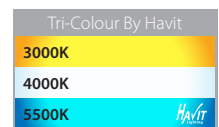

PART NUMBER	COLOUR TEMP	LUMENS	INPUT	INCLUDED LED
HV1625T-BLK-240V	3000K - 4000K - 5500K	1900lm - 1970lm - 2040lm	240v	Tri-Colour Built-in 24w SMD
HV1625T-BLK-24V	3000K - 4000K - 5500K	1900lm - 1970lm - 2040lm	24v DC	Tri-Colour Built-in 24w SMD
HV1626T-BLK-240V	3000K - 4000K - 5500K	1900lm - 1970lm - 2040lm	240v	Tri-Colour Built-in 24w SMD
HV1626T-BLK-24V	3000K - 4000K - 5500K	1900lm - 1970lm - 2040lm	24v DC	Tri-Colour Built-in 24w SMD

See pages 295-306 for compatible drivers. All low voltage products that specify an input of 12v or 24v DC must be used with a suitable LED driver.



For detailed product specifications
visit www.Havit.com.au
or scan this QR code

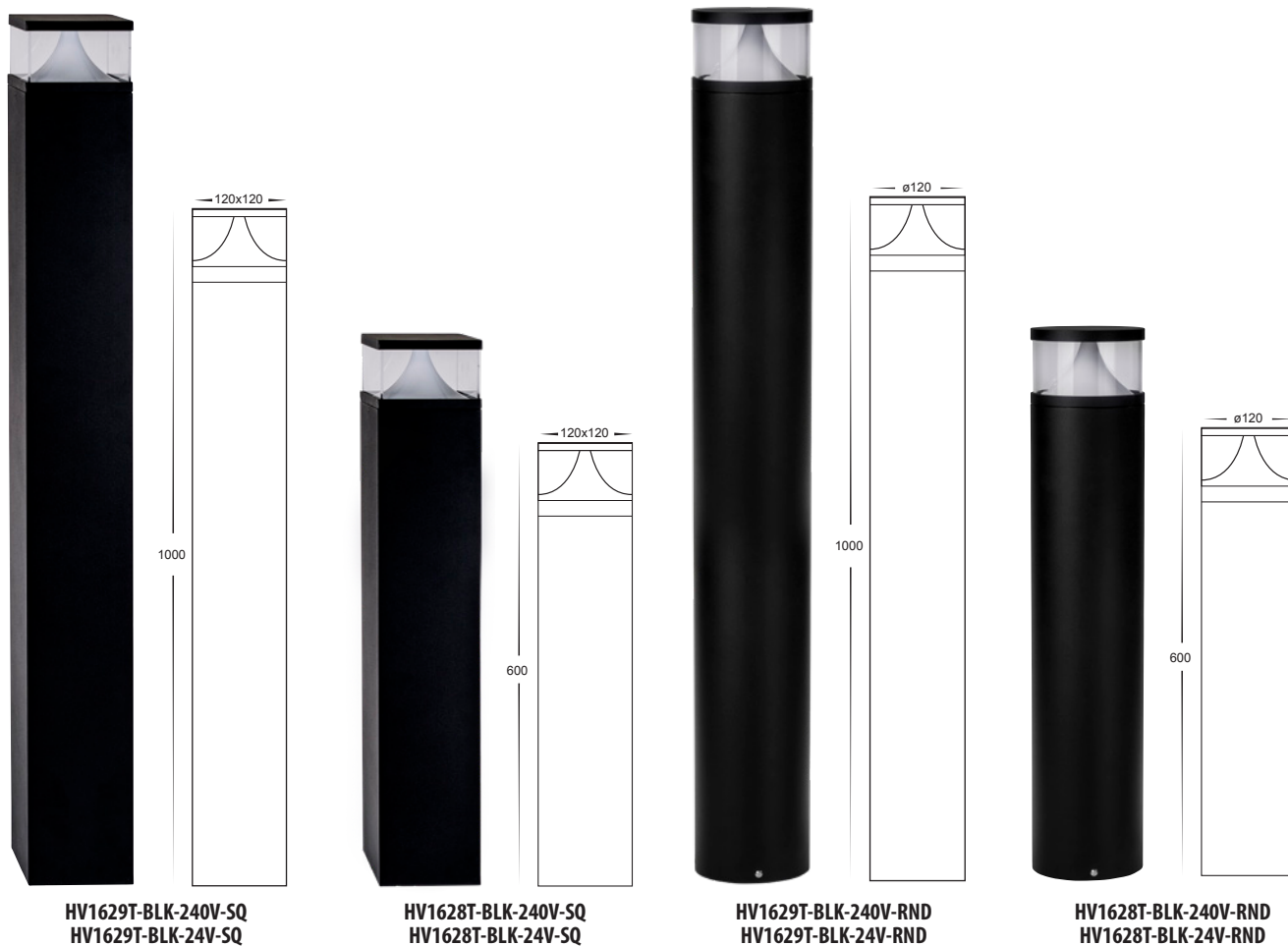

HV1629T-BLK-240V-SQ
HV1629T-BLK-24V-SQ

HV1628T-BLK-240V-SQ
HV1628T-BLK-24V-SQ

HV1629T-BLK-240V-RND
HV1629T-BLK-24V-RND

HV1628T-BLK-240V-RND
HV1628T-BLK-24V-RND

Divad Aluminium Black

- LED Bollard light
- Aluminium Poly Powder Coated Black
- 600mm and 1000mm height
- IP Rating: IP65
- IK Rating: IK08

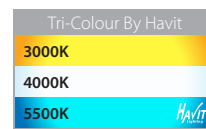

PART NUMBER	COLOUR TEMP	LUMENS	INPUT	INCLUDED LED
HV1628T-BLK-240V-SQ	3000K - 4000K - 5500K	960lm - 1020lm - 1080lm	240v	Tri-Colour Built in 12w SMD
HV1628T-BLK-24V-SQ	3000K - 4000K - 5500K	960lm - 1020lm - 1080lm	24v DC	Tri-Colour Built in 12w SMD
HV1629T-BLK-240V-SQ	3000K - 4000K - 5500K	960lm - 1020lm - 1080lm	240v	Tri-Colour Built in 12w SMD
HV1629T-BLK-24V-SQ	3000K - 4000K - 5500K	960lm - 1020lm - 1080lm	24v DC	Tri-Colour Built in 12w SMD
HV1628T-BLK-240V-RND	3000K - 4000K - 5500K	960lm - 1020lm - 1080lm	240v	Tri-Colour Built in 12w SMD
HV1628T-BLK-24V-RND	3000K - 4000K - 5500K	960lm - 1020lm - 1080lm	24v DC	Tri-Colour Built in 12w SMD
HV1629T-BLK-240V-RND	3000K - 4000K - 5500K	960lm - 1020lm - 1080lm	240v	Tri-Colour Built in 12w SMD
HV1629T-BLK-24V-RND	3000K - 4000K - 5500K	960lm - 1020lm - 1080lm	24v DC	Tri-Colour Built in 12w SMD

See pages 295-306 for compatible drivers. All low voltage products that specify an input of 12v or 24v DC must be used with a suitable LED driver.



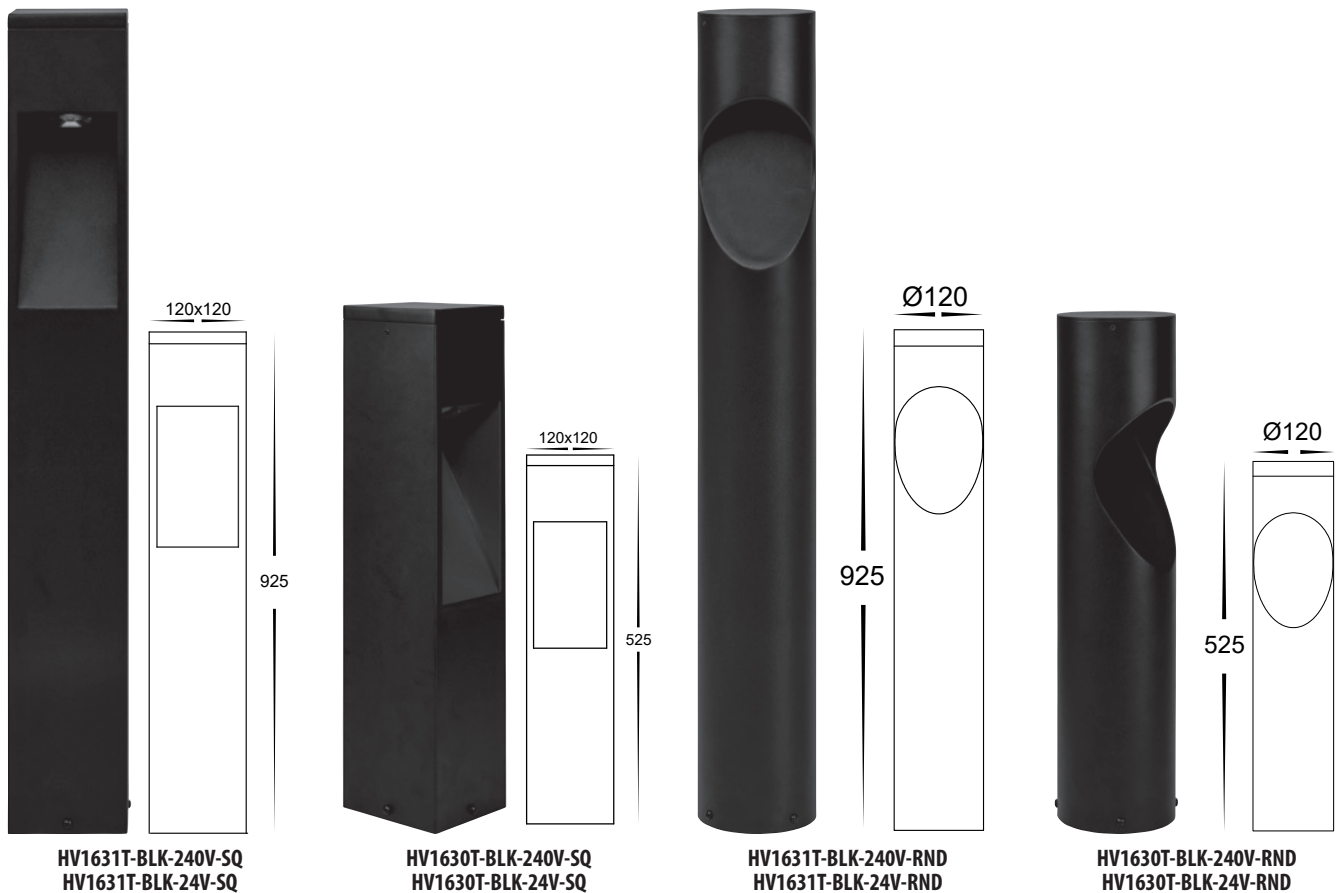

HV1631T-BLK-240V-SQ
HV1631T-BLK-24V-SQ

HV1630T-BLK-240V-SQ
HV1630T-BLK-24V-SQ

HV1631T-BLK-240V-RND
HV1631T-BLK-24V-RND

HV1630T-BLK-240V-RND
HV1630T-BLK-24V-RND

Fedor Aluminium Black

- LED Bollard light
- Aluminium Poly Powder Coated Black
- Single direction light output
- 525mm and 925mm height
- IP Rating: IP65
- IK Rating: IK10

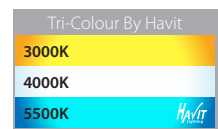

PART NUMBER	COLOUR TEMP	LUMENS	INPUT	INCLUDED LED
HV1630T-BLK-240V-SQ	3000K - 4000K - 5500K	770lm - 780lm - 775lm	240v	Tri-Colour Built-in 12w COB
HV1630T-BLK-24V-SQ	3000K - 4000K - 5500K	770lm - 780lm - 775lm	24v DC	Tri-Colour Built-in 12w COB
HV1631T-BLK-240V-SQ	3000K - 4000K - 5500K	770lm - 780lm - 775lm	240v	Tri-Colour Built-in 12w COB
HV1631T-BLK-24V-SQ	3000K - 4000K - 5500K	770lm - 780lm - 775lm	24v DC	Tri-Colour Built-in 12w COB
HV1630T-BLK-240V-RND	3000K - 4000K - 5500K	610lm - 620lm - 615lm	240v	Tri-Colour Built-in 12w COB
HV1630T-BLK-24V-RND	3000K - 4000K - 5500K	610lm - 620lm - 615lm	24v DC	Tri-Colour Built-in 12w COB
HV1631T-BLK-240V-RND	3000K - 4000K - 5500K	610lm - 620lm - 615lm	240v	Tri-Colour Built-in 12w COB
HV1631T-BLK-24V-RND	3000K - 4000K - 5500K	610lm - 620lm - 615lm	24v DC	Tri-Colour Built-in 12w COB

See pages 295-306 for compatible drivers. All low voltage products that specify an input of 12v or 24v DC must be used with a suitable LED driver.



For detailed product specifications
visit www.Havit.com.au
or scan this QR code

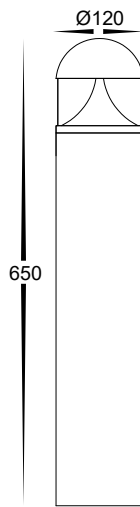

HV1632T-BLK-240V-RND
HV1632T-BLK-24V-RND

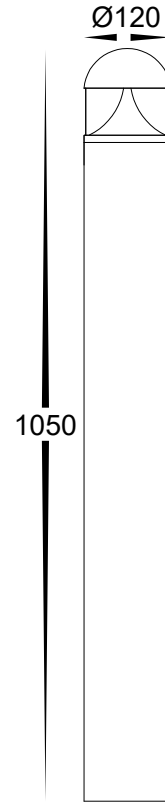

HV1633T-BLK-240V-RND
HV1633T-BLK-24V-RND

Divad Aluminium

- LED Bollard Light
- Aluminium Poly Powder Coated Black
- 650mm and 1050mm Height
- IP Rating: IP65
- IK Rating: IK08

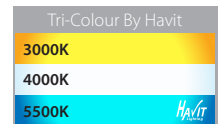

PART NUMBER	COLOUR TEMP	LUMENS	INPUT	INCLUDED LED
HV1632T-BLK-240V-RND	3000K - 4000K - 5500K	960lm - 1020lm - 1080lm	240v	Tri-Colour 12w Built in LED
HV1632T-BLK-24V-RND	3000K - 4000K - 5500K	960lm - 1020lm - 1080lm	24v DC	Tri-Colour 12w Built in LED
HV1633T-BLK-240V-RND	3000K - 4000K - 5500K	960lm - 1020lm - 1080lm	240v	Tri-Colour 12w Built in LED
HV1633T-BLK-24V-RND	3000K - 4000K - 5500K	960lm - 1020lm - 1080lm	24v DC	Tri-Colour 12w Built in LED

See pages 295-306 for compatible drivers. All low voltage products that specify an input of 12v or 24v DC must be used with a suitable LED driver.





HV1638T-BLK-240V
HV1638T-BLK-24V



HV1639T-BLK-240V
HV1639T-BLK-24V

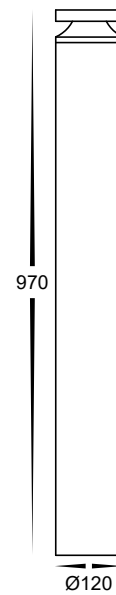
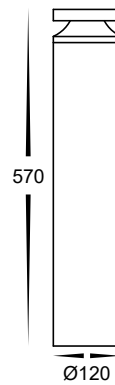

Noray Aluminium

- Round Aluminium Bollard Lights
- Aluminium Poly Powder Coated Black
- High Grade UV Resistant Perspex Lens
- 570mm and 970mm Height
- IP Rating: IP65
- IK Rating: IK08

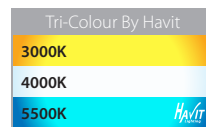

PART NUMBER	COLOUR TEMP	LUMENS	INPUT	INCLUDED LED
HV1638T-BLK-240V	3000K - 4000K - 5500K	285lm - 330lm - 305lm	240v	TRI Colour 12w Built in LED
HV1638T-BLK-24V	3000K - 4000K - 5500K	285lm - 330lm - 305lm	24v DC	TRI Colour 12w Built in LED
HV1639T-BLK-240V	3000K - 4000K - 5500K	285lm - 330lm - 305lm	240v	TRI Colour 12w Built in LED
HV1639T-BLK-24V	3000K - 4000K - 5500K	285lm - 330lm - 305lm	24v DC	TRI Colour 12w Built in LED

See pages 295-306 for compatible drivers. All low voltage products that specify an input of 12v or 24v DC must be used with a suitable LED driver.



For detailed product specifications
visit www.Havit.com.au
or scan this QR code



HV1671W-BLK

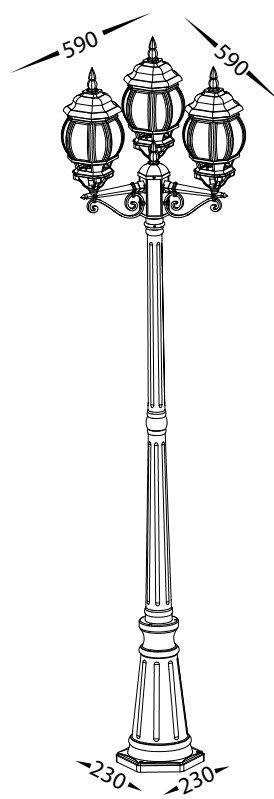

HV1673W-BLK

Trener Aluminium Black

- LED Post Light
- Aluminium Powder Coated Black
- 1 and 3 lights available
- 2070mm & 2165mm Height
- IP Rating: IP44
- IK Rating: IK08



PART NUMBER	COLOUR TEMP	LUMENS	INPUT	INCLUDED LED
HV1671W-BLK	2700k	700lm	240V	9w E27 LED Filament Globe
HV1673W-BLK	2700k	3x 700lm	240V	3x 9w E27 LED Filament Globe





HV1691T-BLK-240V
Otaner



HV1692W-BLK
Angela

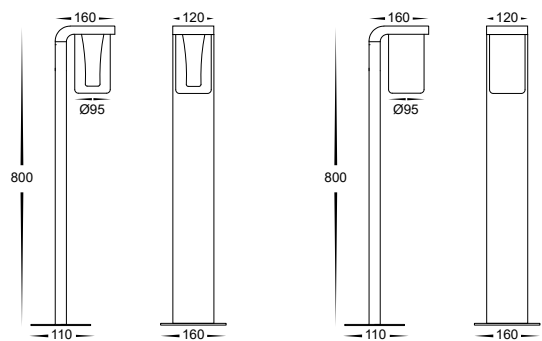

Aluminium Black

- LED Post Light
- Aluminium Poly Powder Coated Black
- 800mm Height
- IP Rating: IP54
- IK Rating: IK04

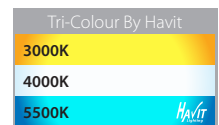

PART NUMBER	COLOUR TEMP	LUMENS	INPUT	INCLUDED LED
HV1691T-BLK-240V	3000K - 4000K - 5500K	695lm - 730lm - 710lm	240V	Tri Colour 10w Built in LED
HV1692W-BLK	2700k	700lm	240V	9w E27 LED Filament Globe



For detailed product specifications
visit www.Havit.com.au
or scan this QR code

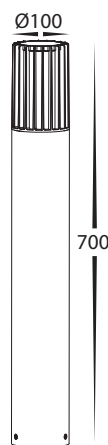

HV1693T-BLK-240V

Tenac Aluminium Black

- LED Bollard Light
- Aluminium Poly Powder Coated Black
- 700mm Height
- IP Rating: IP54
- IK Rating: IK08

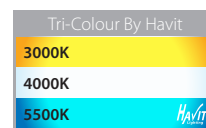

PART NUMBER	COLOUR TEMP	LUMENS	INPUT	INCLUDED LED
HV1693T-BLK-240V	3000K - 4000K - 5500K	700lm - 740lm - 720lm	240V	Tri Colour 9w E27 LED





HV1699T-BLK-240V-RND
HV1699T-BLK-24V-RND



HV1699T-BLK-240V-SQ
HV1699T-BLK-24V-SQ

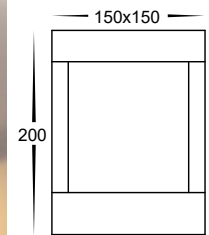
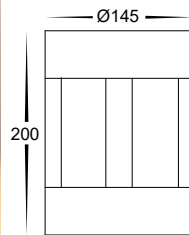

Pelare

- Pillar Light
- Aluminium Poly Powder Coated Black
- IP Rating: IP65

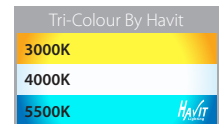

PART NUMBER	COLOUR TEMP	LUMENS	INPUT	INCLUDED LED
HV1699T-BLK-240V-RND	3000K - 4000K - 5500K	700lm - 750lm - 730lm	240V	Tri-Colour Built in 12w COB
HV1699T-BLK-24V-RND	3000K - 4000K - 5500K	700lm - 750lm - 730lm	24v DC	Tri-Colour Built in 12w COB
HV1699T-BLK-240V-SQ	3000K - 4000K - 5500K	700lm - 750lm - 730lm	240V	Tri-Colour Built in 12w COB
HV1699T-BLK-24V-SQ	3000K - 4000K - 5500K	700lm - 750lm - 730lm	24v DC	Tri-Colour Built in 12w COB

See pages 295-306 for compatible drivers. All low voltage products that specify an input of 12v or 24v DC must be used with a suitable LED driver.



For detailed product specifications
visit www.Havit.com.au
or scan this QR code



**HV1701T
HV1706T**



HV1701RGBW



**HV1801T
HV1806T**



HV1801RGBW

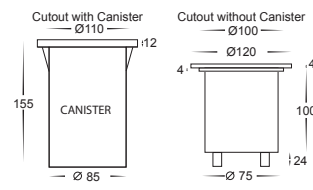
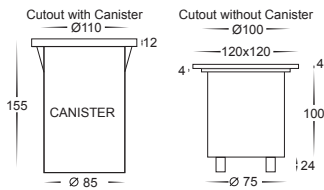

Metro 316 Stainless Steel

- Inground uplighter square and round
- Stainless Steel 316 Marine Grade cover
- Flush tempered glass
- Trafficable to 600Kg
- Face: 120mm x 120mm / Ø120mm
- Installation depth: 155mm
- IK Rating: IK08
- IP Rating: IP65
- NOTE: Adequate drainage must be allowed

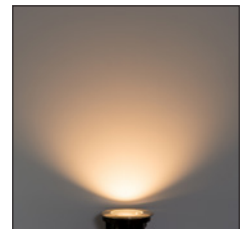
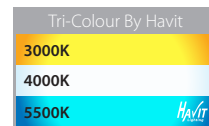

PART NUMBER	COLOUR TEMP	LUMENS	INPUT	INCLUDED LED
HV1701T	3000K - 4000K - 5500K	270lm - 285lm - 300lm	12v DC	Tri-Colour 5w MR16 LED
HV1706T	3000K - 4000K - 5500K	270lm - 285lm - 300lm	240v	Tri-Colour 5w GU10 LED
HV1701RGBW	RGB+3000K	255lm (3000K)	12v DC	RGBW Built in 5w LED
HV1801T	3000K - 4000K - 5500K	270lm - 285lm - 300lm	12v DC	Tri-Colour 5w MR16 LED
HV1806T	3000K - 4000K - 5500K	270lm - 285lm - 300lm	240v	Tri-Colour 5w GU10 LED
HV1801RGBW	RGB+3000K	255lm (3000K)	12v DC	RGBW Built in 5w LED

HAVIT COMPATIBLE ACCESSORIES

HV9507	3000K - 4000K - 5500K	240lm-630lm	12v DC	Tri-Colour 3W/5W/7W MR16 LED
HV9508	3000K - 4000K - 5500K	240lm-630lm	24v DC	Tri-Colour 3W/5W/7W MR16 LED

See pages 295-306 for compatible drivers. All low voltage products that specify an input of 12v or 24v DC must be used with a suitable LED driver.

RGBW Models can be used with any RGBW Controller in LED Controller section of this catalogue.





HV1825T-SQ

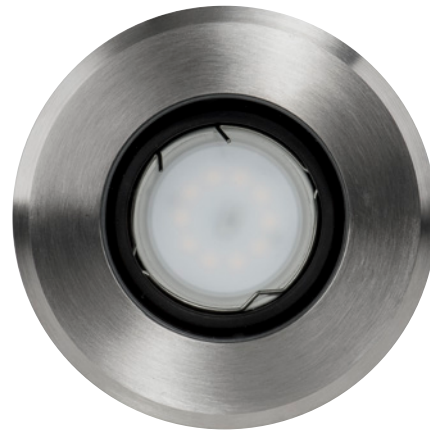

HV1825T

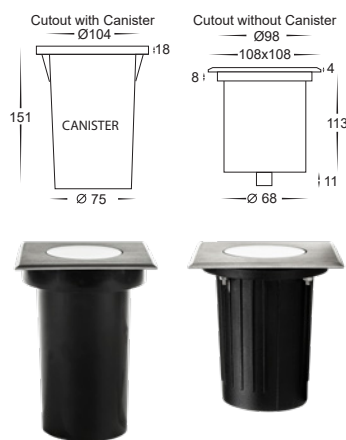

Luta 316 Stainless Steel

- Adjustable square and round inground uplighter
- Stainless Steel 316 Marine Grade cover
- 30° Tilt
- Trafficable to 500Kg
- Flush Tempered glass
- Face: 108x108mm / $\varnothing 108$ mm
- Installation depth needed: 160mm
- IK Rating: IK10
- IP Rating: IP67
- NOTE: Adequate drainage must be allowed

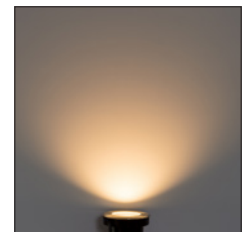
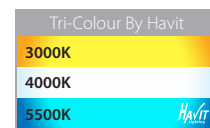

PART NUMBER	COLOUR TEMP	LUMENS	INPUT	INCLUDED LED
HV1825T-SQ	3000K - 4000K - 5500K	270lm - 285lm - 300lm	12v DC	Tri-Colour 5w MR16 LED
HV1825T	3000K - 4000K - 5500K	270lm - 285lm - 300lm	12v DC	Tri-Colour 5w MR16 LED
HAVIT COMPATIBLE ACCESSORIES				
HV9507	3000K - 4000K - 5500K	240lm-630lm	12v DC	Tri-Colour 3W/5W/7W MR16 LED
HV9508	3000K - 4000K - 5500K	240lm-630lm	24v DC	Tri-Colour 3W/5W/7W MR16 LED

See pages 295-306 for compatible drivers. All low voltage products that specify an input of 12v or 24v DC must be used with a suitable LED driver.



For detailed product specifications
visit www.Havit.com.au
or scan this QR code



Face: 108mm
Tilt: 20°
HV1827T



Face: 160mm
Tilt: 30°
HV1828T



Face: 230mm
Tilt: 15°
HV1829T

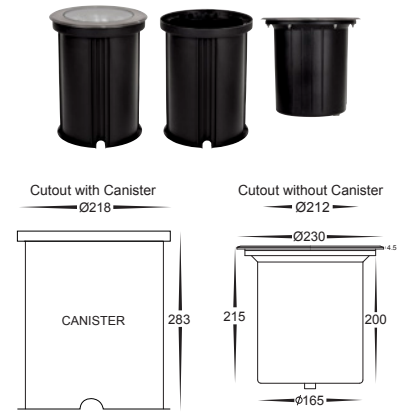
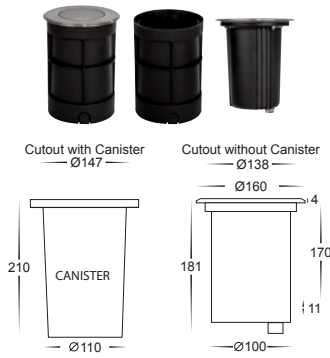
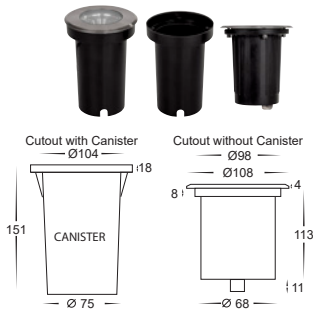

Toldo 316 Stainless Steel

- Adjustable round inground uplighter
- Stainless Steel 316 Marine Grade cover
- 30° Beam angle
- Trafficable to 1000Kg
- Flush Tempered glass
- Installation depth HV1827: 160mm
- Installation depth HV1828: 220mm
- Installation depth HV1829: 290mm
- IK Rating: IK10
- IP Rating: IP67
- NOTE: Adequate drainage must be allowed

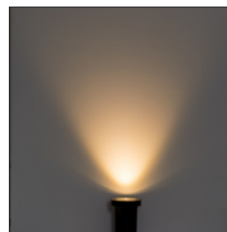
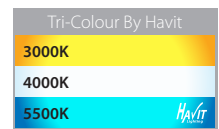

HV1827



HV1828



HV1829

PART NUMBER	COLOUR TEMP	LUMENS	INPUT	INCLUDED LED
HV1827T	3000K - 4000K - 5500K	270lm - 285lm - 300lm	12v DC	Tri-Colour Built in 3w LED
HV1828T	3000K - 4000K - 5500K	450lm - 475lm - 500lm	12v DC	Tri-Colour Built in 5w LED
HV1829T	3000K - 4000K - 5500K	1600lm - 1700lm - 1800lm	24v DC	Tri-Colour Built in 20w LED

See pages 295-306 for compatible drivers. All low voltage products that specify an input of 12v or 24v DC must be used with a suitable LED driver.





HV1831T-12V
HV1831T-240V

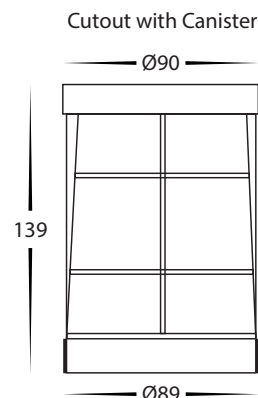
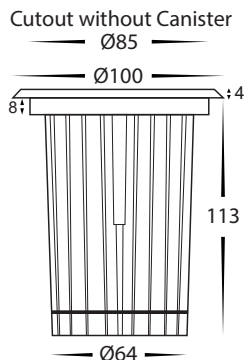

HV1831-F-SH

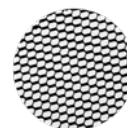

HV1831-HC

Klip 316 Stainless Steel

- Inground uplighter round
- Stainless Steel 316 Marine Grade cover
- Beam angle: 38°
- Flush tempered glass
- Trafficable to 1000Kg
- Face diameter: 100mm
- Installation depth: 145mm
- IK Rating: IK10
- IP Rating: IP67
- NOTE: Adequate drainage must be allowed

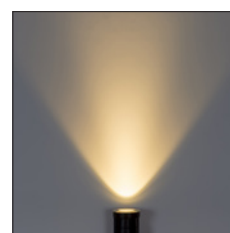
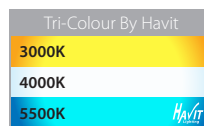

PART NUMBER	COLOUR TEMP	LUMENS	INPUT	INCLUDED LED
HV1831T-12V	3000K - 4000K - 5500K	560lm - 595lm - 630lm	12v DC	Tri-Colour Built in 7w LED
HV1831T-240V	3000K - 4000K - 5500K	560lm - 595lm - 630lm	240v	Tri-Colour Built in 7w LED
HAVIT COMPATIBLE ACCESSORIES				
HV1831-F-SH	316 Stainless Steel Security Face with screw holes to suit HV1831 range			
HV1831-HC	Honeycomb glare reduction lens to suit HV1831 range			
See pages 295-306 for compatible drivers. All low voltage products that specify an input of 12v or 24v DC must be used with a suitable LED driver.				



For detailed product specifications
visit www.Havit.com.au
or scan this QR code



HV1832T-12V
HV1832T-240V

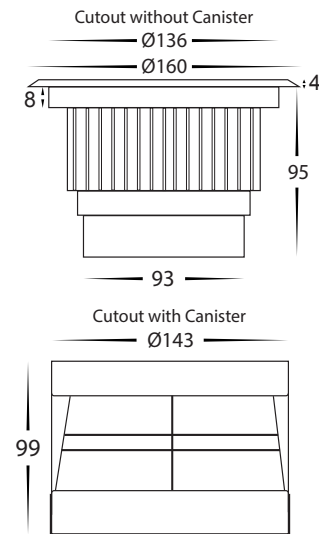

HV1832-F-SH

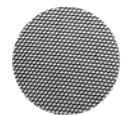

HV1832-HC

Klip 316 Stainless Steel

- Inground uplighter round
- Stainless Steel 316 Marine Grade cover
- Beam angle: 120°
- Flush tempered glass
- Trafficable to 1000Kg
- Face diameter: 160mm
- Installation depth: 120mm
- IK Rating: IK10
- IP Rating: IP67
- NOTE: Adequate drainage must be allowed

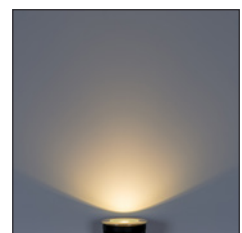
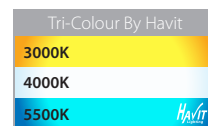

PART NUMBER	COLOUR TEMP	LUMENS	INPUT	INCLUDED LED
HV1832T-12V	3000K - 4000K - 5500K	800lm - 850lm - 900lm	12v DC	Tri-Colour Built in 10w LED
HV1832T-240V	3000K - 4000K - 5500K	800lm - 850lm - 900lm	240v	Tri-Colour Built in 10w LED
HAVIT COMPATIBLE ACCESSORIES				
HV1832-F-SH	316 Stainless Steel Security Face with screw holes to suit HV1832 range			
HV1832-HC	Honeycomb glare reduction lens to suit HV1832 range			

See pages 295-306 for compatible drivers. All low voltage products that specify an input of 12v or 24v DC must be used with a suitable LED driver.



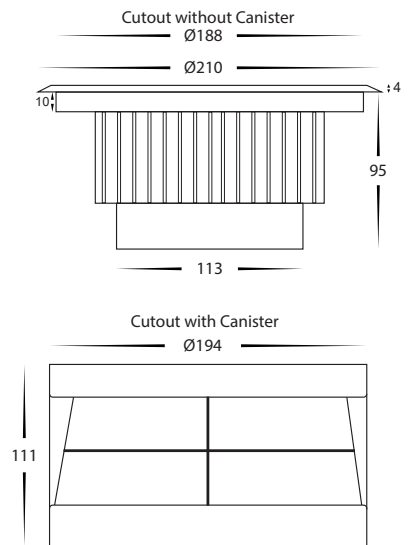

HV1833T-12V
HV1833T-240V



HV1833-F-SH

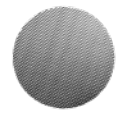

HV1833-HC

Klip 316 Stainless Steel

- Inground uplighter round
- Stainless Steel 316 Marine Grade cover
- Beam angle: 120°
- Flush tempered glass
- Trafficable to 1000Kg
- Face diameter: 210mm
- Installation depth: 115mm
- IK Rating: IK10
- IP Rating: IP67
- NOTE: Adequate drainage must be allowed

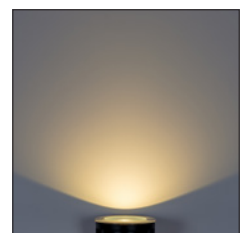
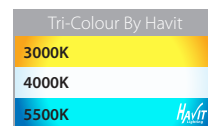

PART NUMBER	COLOUR TEMP	LUMENS	INPUT	INCLUDED LED
HV1833T-12V	3000K - 4000K - 5500K	1600lm - 1700lm - 1800lm	12v DC	Tri-Colour Built in 20w LED
HV1833T-240V	3000K - 4000K - 5500K	1600lm - 1700lm - 1800lm	240v	Tri-Colour Built in 20w LED
HAVIT COMPATIBLE ACCESSORIES				
HV1833-F-SH	316 Stainless Steel Security Face with screw holes to suit HV1833 range			
HV1833-HC	Honeycomb glare reduction lens to suit HV1833 range			

See pages 295-306 for compatible drivers. All low voltage products that specify an input of 12v or 24v DC must be used with a suitable LED driver.



For detailed product specifications
visit www.Havit.com.au
or scan this QR code



HV1834T-12V
HV1834T-240V

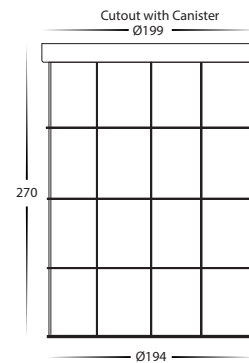
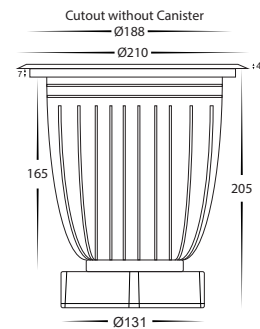

HV1834-F-SH

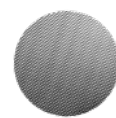

HV1834-HC

Klip 316 Stainless Steel

- Inground uplighter round narrow beam
- Stainless Steel 316 Marine Grade cover
- Beam angle: 60°
- Flush tempered glass
- Trafficable to 1000Kg
- Face diameter: 210mm
- Installation depth: 275mm
- IK Rating: IK10
- IP Rating: IP67
- NOTE: Adequate drainage must be allowed

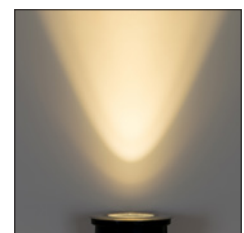
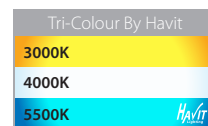

PART NUMBER	COLOUR TEMP	LUMENS	INPUT	INCLUDED LED
HV1834T-12V	3000K - 4000K - 5500K	2400lm - 2550lm - 2700lm	12v DC	Tri-Colour Built in 30w LED
HV1834T-240V	3000K - 4000K - 5500K	2400lm - 2550lm - 2700lm	240v	Tri-Colour Built in 30w LED
HAVIT COMPATIBLE ACCESSORIES				
HV1834-F-SH	316 Stainless Steel Security Face with screw holes to suit HV1834 range			
HV1834-HC	Honeycomb glare reduction lens to suit HV1834 range			

See pages 295-306 for compatible drivers. All low voltage products that specify an input of 12v or 24v DC must be used with a suitable LED driver.





HV1835T-12V
HV1835T-240V

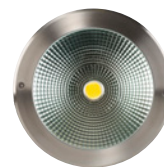
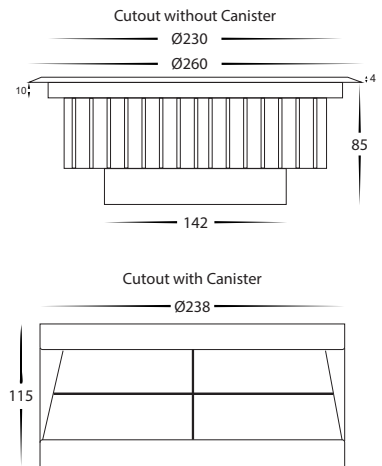

HV1835-F-SH

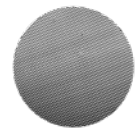

HV1835-HC

Klip 316 Stainless Steel

- Inground uplighter round
- Stainless Steel 316 Marine Grade cover
- Beam angle: 120°
- Flush tempered glass
- Trafficable to 1000Kg
- Face diameter: 260mm
- Installation depth: 130mm
- IK Rating: IK10
- IP Rating: IP67
- NOTE: Adequate drainage must be allowed

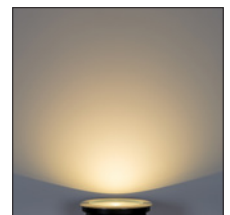
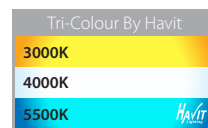

PART NUMBER	COLOUR TEMP	LUMENS	INPUT	INCLUDED LED
HV1835T-12V	3000K - 4000K - 5500K	2400lm - 2550lm - 2700lm	12v DC	Tri-Colour Built in 30w LED
HV1835T-240V	3000K - 4000K - 5500K	2400lm - 2550lm - 2700lm	240v	Tri-Colour Built in 30w LED
HAVIT COMPATIBLE ACCESSORIES				
HV1835-F-SH	316 Stainless Steel Security Face with screw holes to suit HV1835 range			
HV1835-HC	Honeycomb glare reduction lens to suit HV1835 range			

See pages 295-306 for compatible drivers. All low voltage products that specify an input of 12v or 24v DC must be used with a suitable LED driver.



For detailed product specifications
visit www.Havit.com.au
or scan this QR code



**HV1841T
HV1841RGBW**

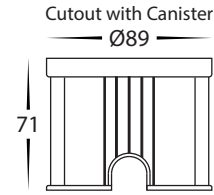
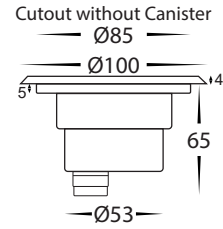

HV1841-F-SH

Split 316 Stainless Steel

- Inground uplighter round
- Stainless Steel 316 Marine Grade cover
- Full stainless steel body
- Anti glare honeycomb louvre
- Beam angle: 60°
- Flush tempered glass
- Trafficable to 1000Kg
- Face diameter: 100mm
- Installation depth: 75mm
- IK Rating: IK10
- IP Rating: IP67
- NOTE: Adequate drainage must be allowed

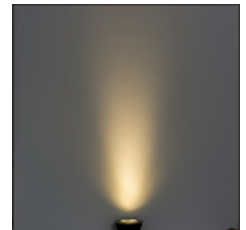
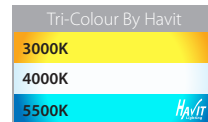

PART NUMBER	COLOUR TEMP	LUMENS	INPUT	INCLUDED LED
HV1841T	3000K - 4000K - 5500K	240lm - 270lm - 300lm	12v DC	Tri-Colour Built-in 3w
HV1841RGBW	RGB + 3000K	115lm (3000K)	12v DC	RGBW Built-in 3w

HAVIT COMPATIBLE ACCESSORIES

HV1841-F-SH	Security Face with screw holes to suit HV1841 range
--------------------	---

See pages 295-306 for compatible drivers. All low voltage products that specify an input of 12v or 24v DC must be used with a suitable LED driver.

RGBW Models can be used with any RGBW Controller in LED Controller section of this catalogue.





**HV1842T
HV1842RGBW**

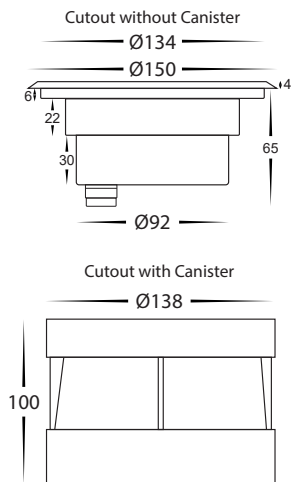

HV1842-F-SH

Split 316 Stainless Steel

- Inground uplighter round
- Stainless Steel 316 Marine Grade cover
- Full stainless steel body
- Anti glare honeycomb louvre
- Beam angle: 60°
- Flush tempered glass
- Trafficable to 1000Kg
- Face diameter: 150mm
- Installation depth: 115mm
- IK Rating: IK10
- IP Rating: IP67
- NOTE: Adequate drainage must be allowed

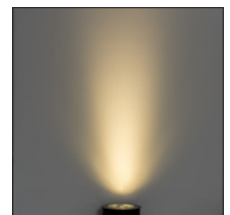
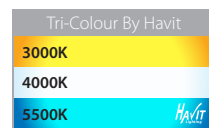

PART NUMBER	COLOUR TEMP	LUMENS	INPUT	INCLUDED LED
HV1842T	3000K - 4000K - 5500K	400lm - 425lm - 450lm	12v DC	Tri-Colour Built-in 5w
HV1842RGBW	RGB + 3000K	195lm (3000K)	12v DC	RGBW Built-in 5w

HAVIT COMPATIBLE ACCESSORIES

HV1842-F-SH	Security Face with screw holes to suit HV1842 range
--------------------	---

See pages 295-306 for compatible drivers. All low voltage products that specify an input of 12v or 24v DC must be used with a suitable LED driver.

RGBW Models can be used with any RGBW Controller in LED Controller section of this catalogue.



For detailed product specifications
visit www.Havit.com.au
or scan this QR code



**HV1843T
HV1843RGBW**

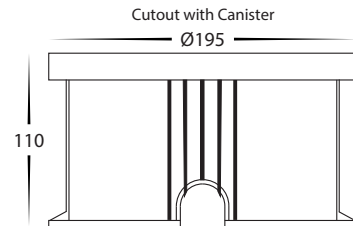
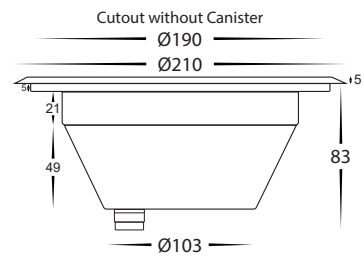

HV1843-F-SH

Split 316 Stainless Steel

- Inground uplighter round
- Stainless Steel 316 Marine Grade cover
- Full stainless steel body
- Anti glare honeycomb louvre
- Beam angle: 60°
- Flush tempered glass
- Trafficable to 1000Kg
- Face diameter: 210mm
- Installation depth: 110mm
- IK Rating: IK10
- IP Rating: IP67
- NOTE: Adequate drainage must be allowed

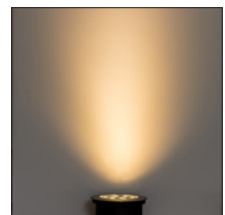
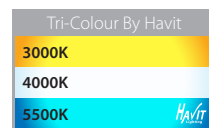

PART NUMBER	COLOUR TEMP	LUMENS	INPUT	INCLUDED LED
HV1843T	3000K - 4000K - 5500K	960lm - 1030lm - 1200lm	12v DC	Tri-Colour Built-in 12w
HV1843RGBW	RGB + 3000K	415lm (3000K)	12v DC	RGBW Built-in 12w

HAVIT COMPATIBLE ACCESSORIES

HV1843-F-SH	Security Face with screw holes to suit HV1843 range
--------------------	---

See pages 295-306 for compatible drivers. All low voltage products that specify an input of 12v or 24v DC must be used with a suitable LED driver.

RGBW Models can be used with any RGBW Controller in LED Controller section of this catalogue.





HV1845T
HV1845RGBW

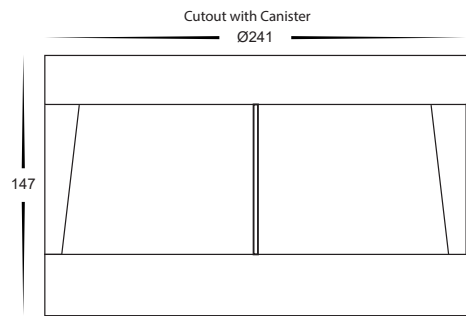
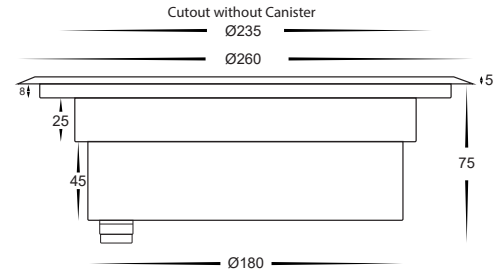

HV1845-F-SH

Split 316 Stainless Steel

- Inground uplighter round
- Stainless Steel 316 Marine Grade cover
- Full stainless steel body
- Anti glare honeycomb louvre
- Beam angle: 60°
- Flush tempered glass
- Trafficable to 1000Kg
- Face diameter: 260mm
- Installation depth: 150mm
- IK Rating: IK10
- IP Rating: IP67
- NOTE: Adequate drainage must be allowed

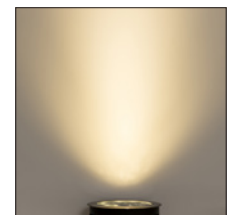
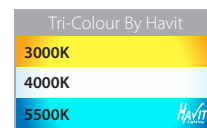

PART NUMBER	COLOUR TEMP	LUMENS	INPUT	INCLUDED LED
HV1845T	3000K - 4000K - 5500K	1200lm - 1290lm - 1350lm	12v DC	Tri-Colour Built-in 18w
HV1845RGBW	RGB + 3000K	550lm (3000K)	12v DC	RGBW Built-in 18w

HAVIT COMPATIBLE ACCESSORIES

HV1845-F-SH	Security Face with screw holes to suit HV1845 range
--------------------	---

See pages 295-306 for compatible drivers. All low voltage products that specify an input of 12v or 24v DC must be used with a suitable LED driver.

RGBW Models can be used with any RGBW Controller in LED Controller section of this catalogue.



For detailed product specifications
visit www.Havit.com.au
or scan this QR code



HV1847T

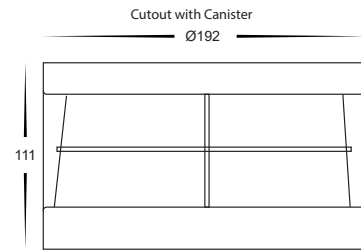
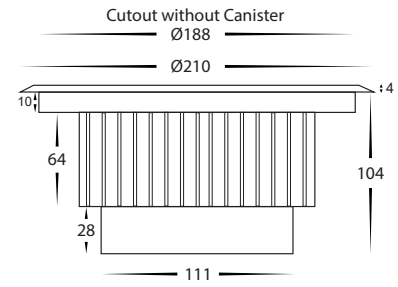

HV1847-F-SH

Split 316 Stainless Steel

- Inground uplighter round
- Stainless Steel 316 Marine Grade cover
- Beam angle: 60°
- Flush tempered glass
- Trafficable to 1000Kg
- Face diameter: 210mm
- Installation depth: 120mm
- IK Rating: IK10
- IP Rating: IP67
- NOTE: Adequate drainage must be allowed

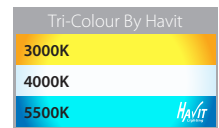
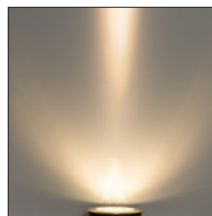

PART NUMBER	COLOUR TEMP	LUMENS	INPUT	INCLUDED LED
HV1847T	3000K - 4000K - 5500K	1650lm - 1800lm - 1710lm	12v DC	Built-in 24w LED
HAVIT COMPATIBLE ACCESSORIES				
HV1847-F-SH	Security Face with screw holes to suit HV1847 range			

See pages 295-306 for compatible drivers. All low voltage products that specify an input of 12v or 24v DC must be used with a suitable LED driver.





Inground with grill
HV19102T

Cutout without Canister Ø63

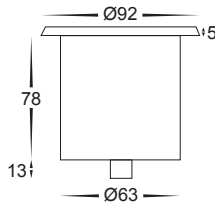

Cutout with Canister Ø87

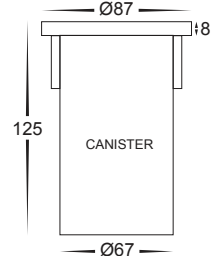

Viale 316 Stainless Steel

- Inground/driveway lights
- Stainless Steel 316 Marine Grade
- Trafficable to 500Kg
- Installation depth needed: 125mm
- IP Rating: IP65
- NOTE: Adequate drainage must be allowed

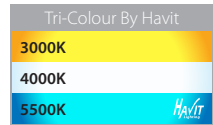

PART NUMBER	COLOUR TEMP	LUMENS	INPUT	INCLUDED LED
HV19102T	3000K - 4000K - 5500K	270lm - 285lm - 300lm	12v DC	Tri-Colour 5w MR16 LED

See pages 295-306 for compatible drivers. All low voltage products that specify an input of 12v or 24v DC must be used with a suitable LED driver.



For detailed product specifications
visit www.Havit.com.au
or scan this QR code



HV19012T-AB
Antique Brass



HV19012T-GPH
Graphite Coloured Brass



HV19012T-BR
Solid Brass

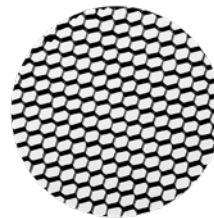
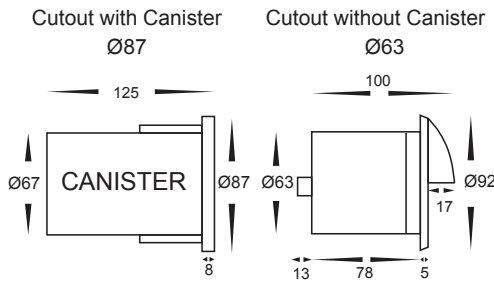

HV190-HC
Honeycomb Lens

Olo

- Recessed wall/step light with eyelid
- Solid Brass, Solid Brass with Antique Brass or Graphite Coloured Finish
- Tempered glass
- Installation depth needed: 125mm
- IP Rating: IP65
- Not suitable for in-ground use.

i Solid Brass and Solid Copper fittings will naturally tarnish. Solid Brass fittings with additional coloured coatings (Antique Brass & Graphite) may tarnish through the coating when installed in outdoor environments.

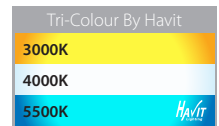

PART NUMBER	COLOUR TEMP	LUMENS	INPUT	INCLUDED LED
HV19012T-AB	3000K - 4000K - 5500K	270lm - 285lm - 300lm	12v DC	Tri-Colour 5w MR16 LED
HV19012T-GPH	3000K - 4000K - 5500K	270lm - 285lm - 300lm	12v DC	Tri-Colour 5w MR16 LED
HV19012T-BR	3000K - 4000K - 5500K	270lm - 285lm - 300lm	12v DC	Tri-Colour 5w MR16 LED
HAVIT COMPATIBLE ACCESSORIES				
HV190-HC	Honeycomb Lens to suit HV19012, HV19022, HV19032 & HV19042			
HV9507	3000K - 4000K - 5500K	240lm-630lm	12v DC	Tri-Colour 3W/5W/7W MR16 LED
HV9508	3000K - 4000K - 5500K	240lm-630lm	24v DC	

See pages 295-306 for compatible drivers. All low voltage products that specify an input of 12v or 24v DC must be used with a suitable LED driver.





HV19012T-SS316
HV19032T-SS316
Stainless Steel 316



HV19012T-BLK
Stainless Steel 316 Black



HV19012T-CP
Solid Copper

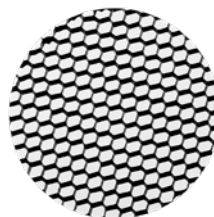
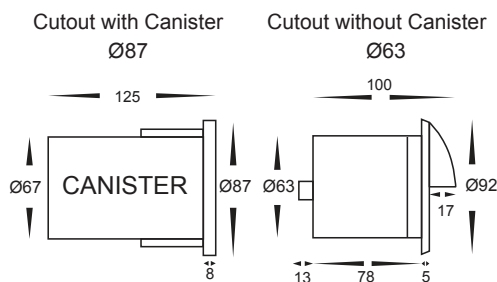

HV190-HC
Honeycomb Lens



Weathered Copper

Olo

- Recessed wall/step light with eyelid
- Stainless Steel, Solid Copper or Black Face With Marine Grade 316 Stainless Steel Body
- Tempered glass
- Installation depth needed: 125mm
- IP Rating: IP65
- Not suitable for in-ground use.



Solid Brass and Solid Copper fittings will naturally tarnish. Solid Brass fittings with additional coloured coatings (Antique Brass & Graphite) may tarnish through the coating when installed in outdoor environments.

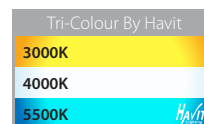

PART NUMBER	COLOUR TEMP	LUMENS	INPUT	INCLUDED LED
HV19012T-SS316	3000K - 4000K - 5500K	270lm - 285lm - 300lm	12v DC	Tri-Colour 5w MR16 LED
HV19032T-SS316	3000K - 4000K - 5500K	270lm - 285lm - 300lm	240v	Tri-Colour 5w GU10 LED
HV19012T-BLK	3000K - 4000K - 5500K	270lm - 285lm - 300lm	12v DC	Tri-Colour 5w MR16 LED
HV19012T-CP	3000K - 4000K - 5500K	270lm - 285lm - 300lm	12v DC	Tri-Colour 5w MR16 LED
HAVIT COMPATIBLE ACCESSORIES				
HV190-HC	Honeycomb Lens to suit HV19012, HV19022, HV19032 & HV19042			
HV9507	3000K - 4000K - 5500K	240lm-630lm	12v DC	Tri-Colour 3W/5W/7W MR16 LED
HV9508	3000K - 4000K - 5500K	240lm-630lm	24v DC	Tri-Colour 3W/5W/7W MR16 LED
HV9506D	3000K - 4000K - 5500K	240lm-630lm	240v	Tri-Colour 3W/5W/7W GU10 LED

See pages 295-306 for compatible drivers. All low voltage products that specify an input of 12v or 24v DC must be used with a suitable LED driver.



For detailed product specifications visit www.Havit.com.au or scan this QR code



HV19022T-AB
Antique Brass



HV19022T-GPH
Graphite Coloured Brass



HV19022T-BR
Solid Brass



Cutout with Canister
Ø87



Cutout without Canister
Ø63

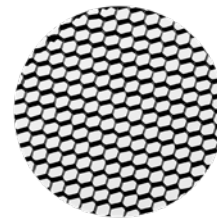
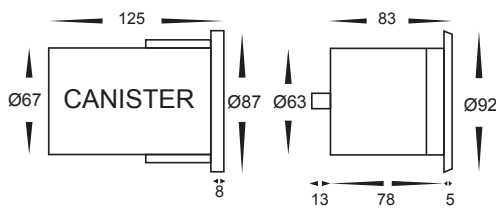

HV190-HC
Honeycomb Lens

Ollo

- Recessed wall/step/inground light
- Solid Brass, Solid Brass with Antique Brass or Graphite Coloured Finish
- Tempered glass
- Trafficable to 500Kg
- Installation depth needed: 125mm
- IP Rating: IP65
- IK Rating: IK08
- NOTE: Adequate drainage must be allowed

i Solid Brass and Solid Copper fittings will naturally tarnish. Solid Brass fittings with additional coloured coatings (Antique Brass & Graphite) may tarnish through the coating when installed in outdoor environments.

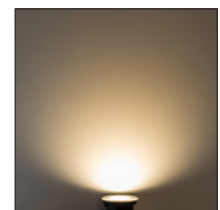
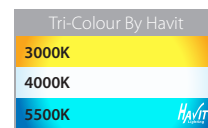

PART NUMBER	COLOUR TEMP	LUMENS	INPUT	INCLUDED LED
HV19022T-AB	3000K - 4000K - 5500K	270lm - 285lm - 300lm	12v DC	Tri-Colour 5w MR16 LED
HV19022T-GPH	3000K - 4000K - 5500K	270lm - 285lm - 300lm	12v DC	Tri-Colour 5w MR16 LED
HV19022T-BR	3000K - 4000K - 5500K	270lm - 285lm - 300lm	12v DC	Tri-Colour 5w MR16 LED
HAVIT COMPATIBLE ACCESSORIES				
HV190-HC	Honeycomb Lens to suit HV19012, HV19022, HV19032 & HV19042			
HV9507	3000K - 4000K - 5500K	240lm-630lm	12v DC	Tri-Colour 3W/5W/7W MR16 LED
HV9508	3000K - 4000K - 5500K	240lm-630lm	24v DC	

See pages 295-306 for compatible drivers. All low voltage products that specify an input of 12v or 24v DC must be used with a suitable LED driver.



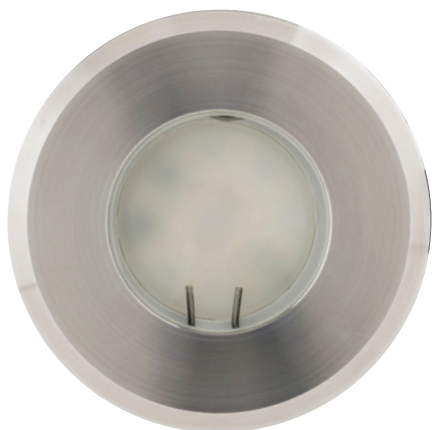

**HV19022T-SS316
HV19042T-SS316
Stainless Steel 316**

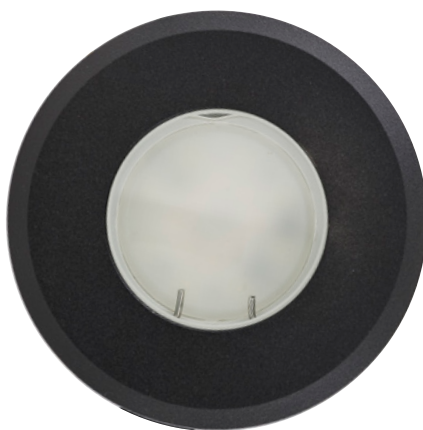

**HV19022T-BLK
Stainless Steel 316 Black**



**HV19022T-CP
Solid Copper**



Cutout with Canister
Ø87



Cutout without Canister
Ø63

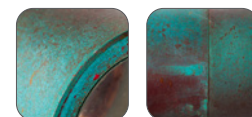

Weathered Copper

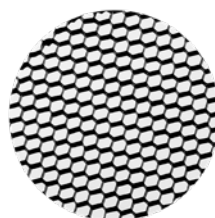
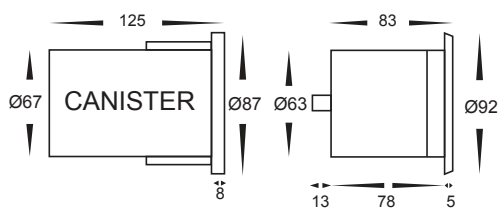

**HV190-HC
Honeycomb Lens**

Olo

- Recessed wall/step/inground light
- Stainless Steel, Solid Copper or Black Face With Marine Grade 316 Stainless Steel Body
- Tempered glass
- Trafficable to 500Kg
- Installation depth needed: 125mm
- IP Rating: IP65
- IK Rating: IK08
- NOTE: Adequate drainage must be allowed



Solid Brass and Solid Copper fittings will naturally tarnish. Solid Brass fittings with additional coloured coatings (Antique Brass & Graphite) may tarnish through the coating when installed in outdoor environments.

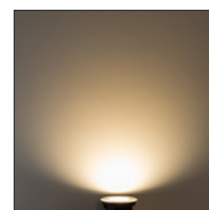
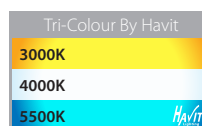

PART NUMBER	COLOUR TEMP	LUMENS	INPUT	INCLUDED LED
HV19022T-SS316	3000K - 4000K - 5500K	270lm - 285lm - 300lm	12v DC	Tri-Colour 5w MR16 LED
HV19042T-SS316	3000K - 4000K - 5500K	270lm - 285lm - 300lm	240v	Tri-Colour 5w GU10 LED
HV19022T-BLK	3000K - 4000K - 5500K	270lm - 285lm - 300lm	12v DC	Tri-Colour 5w MR16 LED
HV19022T-CP	3000K - 4000K - 5500K	270lm - 285lm - 300lm	12v DC	Tri-Colour 5w MR16 LED
HAVIT COMPATIBLE ACCESSORIES				
HV190-HC	Honeycomb Lens to suit HV19012, HV19022, HV19032 & HV19042			
HV9507	3000K - 4000K - 5500K	240lm-630lm	12v DC	Tri-Colour 3W/5W/7W MR16 LED
HV9508	3000K - 4000K - 5500K	240lm-630lm	24v DC	Tri-Colour 3W/5W/7W MR16 LED
HV9506D	3000K - 4000K - 5500K	240lm-630lm	240v	Tri-Colour 3W/5W/7W GU10 LED

See pages 295-306 for compatible drivers. All low voltage products that specify an input of 12v or 24v DC must be used with a suitable LED driver.



For detailed product specifications visit www.Havit.com.au or scan this QR code



HV19062T
316 Stainless Steel



HV19062T-AB
Antique Brass



Cutout without Canister Ø63

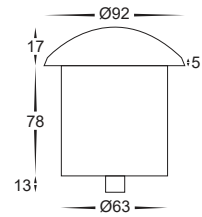

Cutout with Canister Ø87

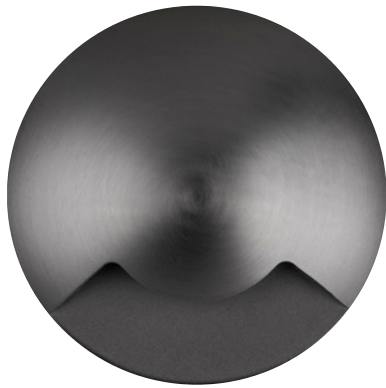
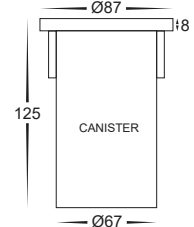

HV19062T-GPH
Graphite Coloured Brass



HV19062T-BR
Solid Brass

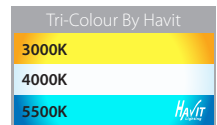
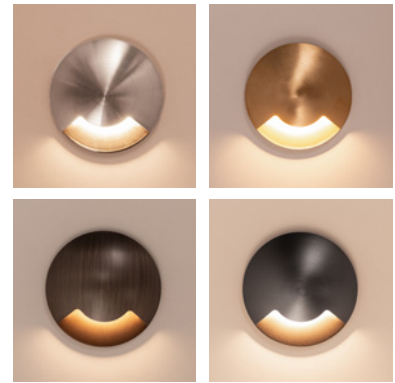

Viale

- Inground/driveway lights
- 316 Stainless Steel, Antique Brass, Brass and Graphite
- Trafficable to 500Kg
- Installation depth needed: 125mm
- IP Rating: IP65
- NOTE: Adequate drainage must be allowed

i Solid Brass fittings will naturally tarnish. Solid Brass fittings with additional coloured coatings (Antique Brass & Graphite) may tarnish through the coating when installed in outdoor environments.

PART NUMBER	COLOUR TEMP	LUMENS	INPUT	INCLUDED LED
HV19062T	3000K - 4000K - 5500K	270lm - 285lm - 300lm	12v DC	Tri-Colour 5w MR16 LED
HV19062T-AB	3000K - 4000K - 5500K	270lm - 285lm - 300lm	12v DC	Tri-Colour 5w MR16 LED
HV19062T-BR	3000K - 4000K - 5500K	270lm - 285lm - 300lm	12v DC	Tri-Colour 5w MR16 LED
HV19062T-GPH	3000K - 4000K - 5500K	270lm - 285lm - 300lm	12v DC	Tri-Colour 5w MR16 LED

See pages 295-306 for compatible drivers. All low voltage products that specify an input of 12v or 24v DC must be used with a suitable LED driver.





HV19072T
316 Stainless Steel



HV19072T-AB
Antique Brass



Cutout without Canister Ø63

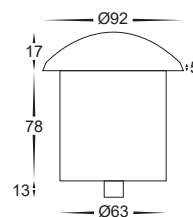

Cutout with Canister Ø87

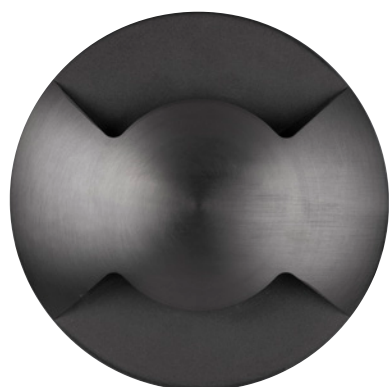
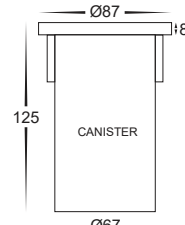

HV19072T-GPH
Graphite Coloured Brass



HV19072T-BR
Solid Brass

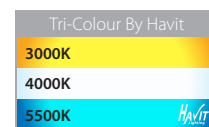

Viale

- Inground/driveway lights
- 316 Stainless Steel, Antique Brass, Brass and Graphite
- Trafficable to 500Kg
- Installation depth needed: 125mm
- IP Rating: IP65
- NOTE: Adequate drainage must be allowed

i Solid Brass fittings will naturally tarnish. Solid Brass fittings with additional coloured coatings (Antique Brass & Graphite) may tarnish through the coating when installed in outdoor environments.

PART NUMBER	COLOUR TEMP	LUMENS	INPUT	INCLUDED LED
HV19072T	3000K - 4000K - 5500K	270lm - 285lm - 300lm	12v DC	Tri-Colour 5w MR16 LED
HV19072T-AB	3000K - 4000K - 5500K	270lm - 285lm - 300lm	12v DC	Tri-Colour 5w MR16 LED
HV19072T-BR	3000K - 4000K - 5500K	270lm - 285lm - 300lm	12v DC	Tri-Colour 5w MR16 LED
HV19072T-GPH	3000K - 4000K - 5500K	270lm - 285lm - 300lm	12v DC	Tri-Colour 5w MR16 LED

See pages 295-306 for compatible drivers. All low voltage products that specify an input of 12v or 24v DC must be used with a suitable LED driver.



For detailed product specifications visit www.Havit.com.au or scan this QR code



HV19082T
316 Stainless Steel



HV19082T-AB
Antique Brass



Cutout without Canister Ø63

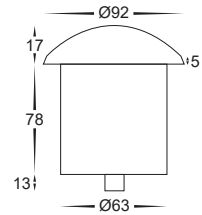

Cutout with Canister Ø87

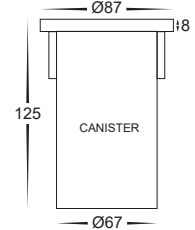

HV19082T-GPH
Graphite Coloured Brass



HV19082T-BR
Solid Brass

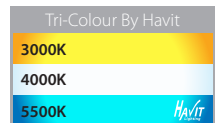

Viale

- Inground/driveway lights
- 316 Stainless Steel, Antique Brass, Brass and Graphite
- Trafficable to 500Kg
- Installation depth needed: 125mm
- IP Rating: IP65
- NOTE: Adequate drainage must be allowed

i Solid Brass fittings will naturally tarnish. Solid Brass fittings with additional coloured coatings (Antique Brass & Graphite) may tarnish through the coating when installed in outdoor environments.

PART NUMBER	COLOUR TEMP	LUMENS	INPUT	INCLUDED LED
HV19082T	3000K - 4000K - 5500K	270lm - 285lm - 300lm	12v DC	Tri-Colour 5w MR16 LED
HV19082T-AB	3000K - 4000K - 5500K	270lm - 285lm - 300lm	12v DC	Tri-Colour 5w MR16 LED
HV19082T-BR	3000K - 4000K - 5500K	270lm - 285lm - 300lm	12v DC	Tri-Colour 5w MR16 LED
HV19082T-GPH	3000K - 4000K - 5500K	270lm - 285lm - 300lm	12v DC	Tri-Colour 5w MR16 LED

See pages 295-306 for compatible drivers. All low voltage products that specify an input of 12v or 24v DC must be used with a suitable LED driver.





HV19092T
316 Stainless Steel



HV19092T-AB
Antique Brass



Cutout without Canister Ø63

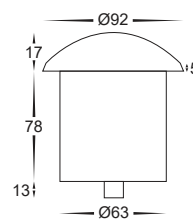

Cutout with Canister Ø87

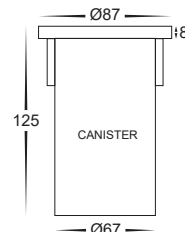

HV19092T-GPH
Graphite Coloured Brass



HV19092T-BR
Solid Brass

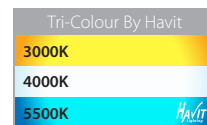

Viale

- Inground/driveway lights
- 316 Stainless Steel, Antique Brass, Brass and Graphite
- Trafficable to 500Kg
- Installation depth needed: 125mm
- IP Rating: IP65
- NOTE: Adequate drainage must be allowed

i Solid Brass fittings will naturally tarnish. Solid Brass fittings with additional coloured coatings (Antique Brass & Graphite) may tarnish through the coating when installed in outdoor environments.

PART NUMBER	COLOUR TEMP	LUMENS	INPUT	INCLUDED LED
HV19092T	3000K - 4000K - 5500K	270lm - 285lm - 300lm	12v DC	Tri-Colour 5w MR16 LED
HV19092T-AB	3000K - 4000K - 5500K	270lm - 285lm - 300lm	12v DC	Tri-Colour 5w MR16 LED
HV19092T-BR	3000K - 4000K - 5500K	270lm - 285lm - 300lm	12v DC	Tri-Colour 5w MR16 LED
HV19092T-GPH	3000K - 4000K - 5500K	270lm - 285lm - 300lm	12v DC	Tri-Colour 5w MR16 LED

See pages 295-306 for compatible drivers. All low voltage products that specify an input of 12v or 24v DC must be used with a suitable LED driver.



For detailed product specifications visit www.Havit.com.au or scan this QR code



6 Light kit
HV2826CCT



6 Light kit
HV2826CCT-BLK

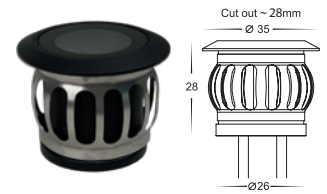
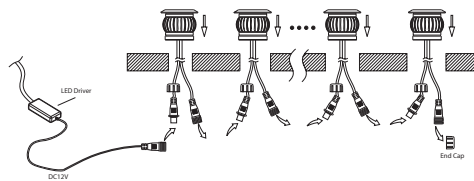
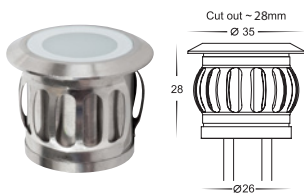

Flame 316 Stainless Steel

- CCT DIY mini deck light
- Stainless Steel 316
- Frosted tempered glass
- 2x 1.5 metre cable length per light
- IP Rating: light fittings IP67 / driver IP66
- Suitable for in-ground installation
- Kit includes:
 - 6 x single deck light (0.5w per light)
 - 1x LED driver
 - 1x 4m extension cable
 - 1x Remote
 - 1x WIFI Receiver



Compatible with major smart home systems.

PART NUMBER	COLOUR TEMP	LUMENS	INPUT	INCLUDED LED
HV2826CCT	2700K-6500K	6x 25lm	240V - LED Driver 12v DC - Fittings	6x 0.5w Fittings with Driver, Receiver and Remote
HV28261CCT	2700K-6500K	25lm	12v DC	CCT 0.5w Built in LED
HV2826CCT-BLK	2700K-6500K	6x 25lm	240V - LED Driver 12v DC - Fittings	6x 0.5w Fittings with Driver, Receiver and Remote
HV28261CCT-BLK	2700K-6500K	25lm	12v DC	CCT 0.5w Built in LED
HAVIT COMPATIBLE ACCESSORIES				
HV2826-D-12W	DIY Decklight 12w 12v IP66 Led Driver To Suit HV28261 Range			
HV2826-EXT-CCT-2M	2m - Extension cable to suit HV2826CCT from fitting to fitting			
HV2826-EXT-CCT-4M	4m - Extension cable to suit HV2826CCT from fitting to fitting			
Max 4 additional fittings (HV28261) can be added to the kit(HV2826). Total 10 fittings with supplied driver. Larger kits can be configured using alternate Havit LED drivers.				





**6 Light kit
HV2826RGCW**



**6 Light kit
HV2826RGCW-BLK**

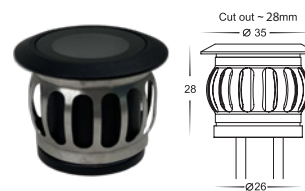
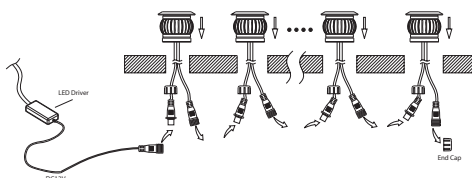
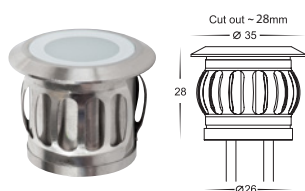

Flame 316 Stainless Steel

- RGCW DIY Mini Deck Lights
- 316 Stainless Steel
- Frosted Glass
- 2x 1.5m Cables Per Light
- IP Rating: Fittings: IP67 | Driver: IP66
- Kit Includes:
 - 6x Deck Lights
 - 1x LED Driver
 - 1x 4m Extension Cable
 - 1x Remote
 - 1x WIFI Receiver



Compatible with major smart home systems.

PART NUMBER	COLOUR TEMP	LUMENS	INPUT	INCLUDED LED
HV2826RGCW	RGB + 3000K + 5500K	6x 25lm	240V - LED Driver 12v DC - Fittings	6x 0.5w Fittings with Driver, Receiver and Remote
HV28261RGCW	RGB + 3000K + 5500K	25lm	12v DC	RGCW 0.5w Built in LED
HV2826RGCW-BLK	RGB + 3000K + 5500K	6x 25lm	240V - LED Driver 12v DC - Fittings	6x 0.5w Fittings with Driver, Receiver and Remote
HV28261RGCW-BLK	RGB + 3000K + 5500K	25lm	12v DC	RGCW 0.5w Built in LED
HAVIT COMPATIBLE ACCESSORIES				
HV2826-D-12W	DIY Decklight 12w 12v IP66 Led Driver To Suit HV28261 Range			
HV2826-EXT-RGCW-2M	Optional 2m extension cable to extend between fittings - Sold Separately			
HV2826-EXT-RGCW-4M	Optional 4m extension cable to extend between fittings - Sold Separately			
Max 4 additional fittings (HV28261) can be added to the kit(HV2826). Total 10 fittings with supplied driver. Larger kits can be configured using alternate Havit LED drivers.				



For detailed product specifications visit www.Havit.com.au or scan this QR code

Tekk 316 Stainless Steel

- Deck light
- 316 Stainless Steel face
- Foot trafficable
- High powered LED chip
- Face Diameter: 64mm
- 1.5 metre cable length
- Beam Angle: 30°
- IP Rating: IP67
- NOTE: Adequate drainage must be allowed
- Not suitable for in-ground installation

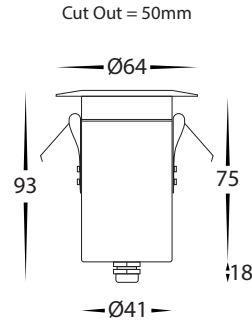

HV2860T-SS316

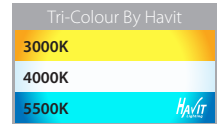
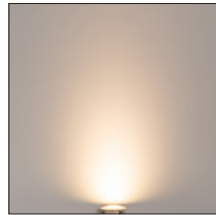

PART NUMBER	COLOUR TEMP	LUMENS	INPUT	INCLUDED LED
HV2860T-SS316	3000K - 4000K - 5500K	160lm - 170lm - 180lm	12v DC	Tri-Colour Built in 3w LED

See pages 295-306 for compatible drivers. All low voltage products that specify an input of 12v or 24v DC must be used with a suitable LED driver.



HV2861C
HV2861W
HV2861B

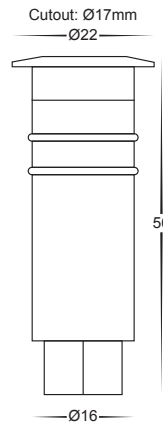
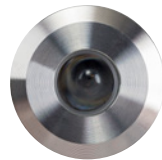

Kett 316 Stainless Steel

- Mini deck light
- 316 Stainless Steel
- Face Diameter: 22mm
- 1.5 metre cable length
- IP Rating: IP65
- NOTE: Adequate drainage must be allowed



PART NUMBER	COLOUR TEMP	LUMENS	INPUT	INCLUDED LED
HV2861C	5500K	35lm	12v DC	Built-in 0.5w
HV2861W	3000K	30lm	12v DC	Built-in 0.5w
HV2861B	Blue	NA	12v DC	Built-in 0.5w

See pages 295-306 for compatible drivers. All low voltage products that specify an input of 12v or 24v DC must be used with a suitable LED driver.



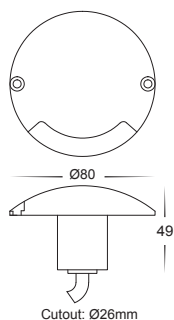

HV2871T-SLV-12V
Aluminium Silver



HV2871T-BLK-12V
Aluminium Black

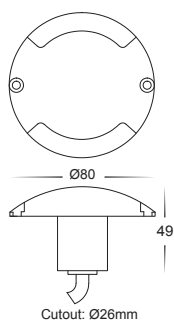

HV2872T-SLV-12V
Aluminium Silver



HV2872T-BLK-12V
Aluminium Black

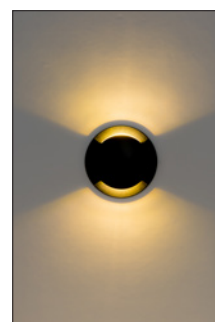

Dome Aluminium

- One-way & two-way recessed deck lights
- Silver Coloured & Poly Powder Coated Black Aluminium
- Foot Trafficable
- IP Rating: IP65
- NOTE: Adequate drainage must be allowed

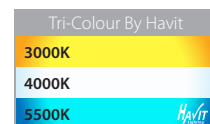

PART NUMBER	COLOUR TEMP	LUMENS	INPUT	INCLUDED LED
HV2871T-SLV-12V	3000K - 4000K - 5500K	180lm - 185lm - 190lm	12v DC	Tri-Colour Built in 3w LED
HV2871T-BLK-12V	3000K - 4000K - 5500K	180lm - 185lm - 190lm	12v DC	Tri-Colour Built in 3w LED
HV2872T-SLV-12V	3000K - 4000K - 5500K	2x 180lm - 2x 185lm - 2x 190lm	12v DC	Tri-Colour Built in 2x 3w LED
HV2872T-BLK-12V	3000K - 4000K - 5500K	2x 180lm - 2x 185lm - 2x 190lm	12v DC	Tri-Colour Built in 2x 3w LED

See pages 295-306 for compatible drivers. All low voltage products that specify an input of 12v or 24v DC must be used with a suitable LED driver.



For detailed product specifications
visit www.Havit.com.au
or scan this QR code

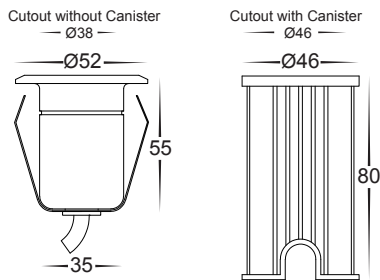

HV2881

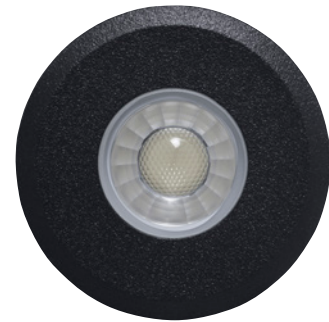
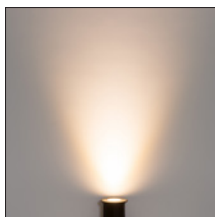
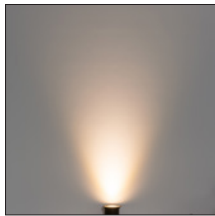

HV2881T-SLV-12V
Aluminium Silver



HV2881T-BLK-12V
Aluminium Black

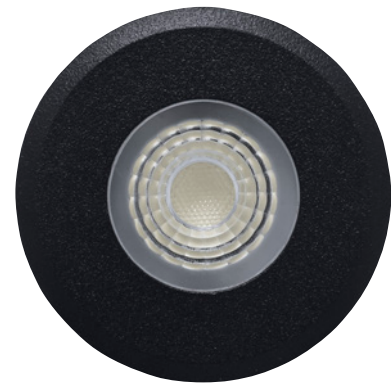

HV2882T-SLV-12V
HV2882RGCW-SLV
Aluminium Silver



HV2882T-BLK-12V
HV2882RGCW-BLK
Aluminium Black

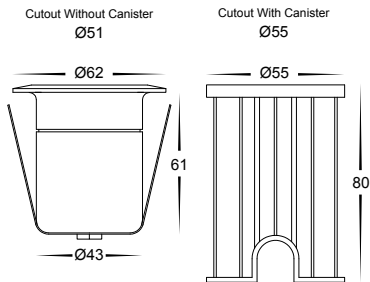

HV2882

Elite Aluminium

- Inground / deck light
- Silver Coloured & Poly Powder Coated Black Aluminium
- IP Rating: IP65
- Dimmable
- NOTE: Adequate drainage must be allowed

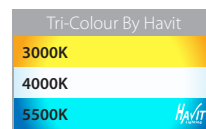

PART NUMBER	COLOUR TEMP	LUMENS	INPUT	INCLUDED LED
HV2881T-SLV-12V	3000K - 4000K - 5500K	240lm - 250lm - 270lm	12v DC	Tri-Colour Built in 3w LED
HV2881T-BLK-12V	3000K - 4000K - 5500K	240lm - 250lm - 270lm	12v DC	Tri-Colour Built in 3w LED
HV2882T-SLV-12V	3000K - 4000K - 5500K	400lm - 420lm - 450lm	12v DC	Tri-Colour Built in 5w LED
HV2882RGCW-SLV	RGB + 3000K + 5500K	200lm (3000k)	12v DC	RGCW Built in 5w LED
HV2882T-BLK-12V	3000K - 4000K - 5500K	400lm - 420lm - 450lm	12v DC	Tri-Colour Built in 5w LED
HV2882RGCW-BLK	RGB + 3000K + 5500K	200lm (3000k)	12v DC	RGCW Built in 5w LED

See pages 295-306 for compatible drivers. All low voltage products that specify an input of 12v or 24v DC must be used with a suitable LED driver.

RGCW Models can be used with suitable Controllers in the LED Controller section of this catalogue



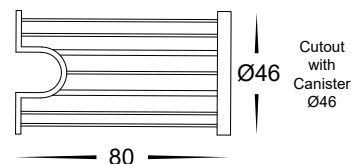
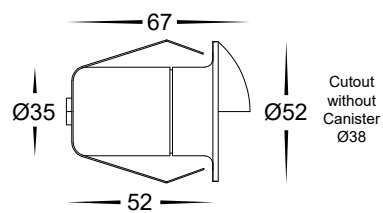
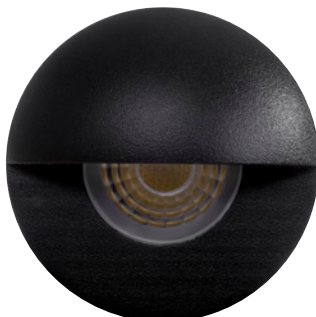
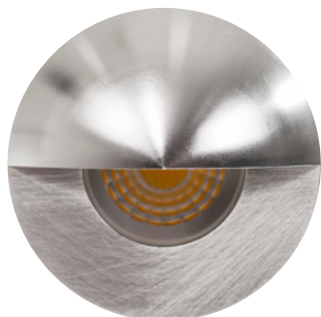

HV2883T-SLV-12V
Aluminium Silver

HV2883T-BLK-12V
Aluminium Black

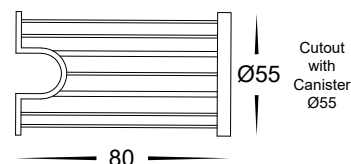
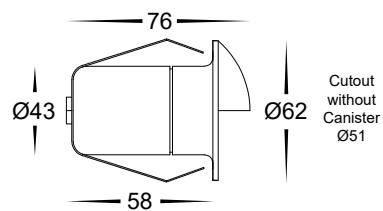

HV2884T-SLV-12V
Aluminium Silver

HV2884T-BLK-12V
Aluminium Black

Elite Aluminium

- Recessed Wall Light with Eyelid
- Silver Coloured & Poly Powder Coated Black Aluminium
- Dimmable
- IP Rating: IP65
- NOTE: Adequate drainage must be allowed

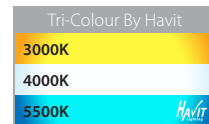

PART NUMBER	COLOUR TEMP	LUMENS	INPUT	INCLUDED LED
HV2883T-SLV-12V	3000K - 4000K - 5500K	220lm - 230lm - 225lm	12v DC	Tri-Colour 3w Built in LED
HV2883T-BLK-12V	3000K - 4000K - 5500K	220lm - 230lm - 225lm	12v DC	Tri-Colour 3w Built in LED
HV2884T-SLV-12V	3000K - 4000K - 5500K	350lm - 360lm - 355lm	12v DC	Tri-Colour 5w Built in LED
HV2884T-BLK-12V	3000K - 4000K - 5500K	350lm - 360lm - 355lm	12v DC	Tri-Colour 5w Built in LED

See pages 295-306 for compatible drivers. All low voltage products that specify an input of 12v or 24v DC must be used with a suitable LED driver.



For detailed product specifications
visit www.Havit.com.au
or scan this QR code



HV2891T-SS316-12V
Stainless Steel 316

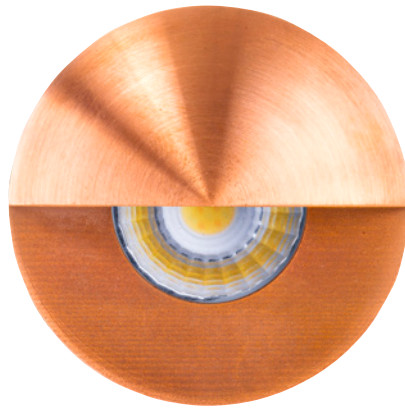

HV2891T-CP-12V
Solid Copper



HV2891T-BLK-12V
Stainless Steel 316 Black

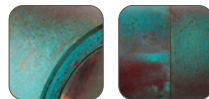

Weathered Copper

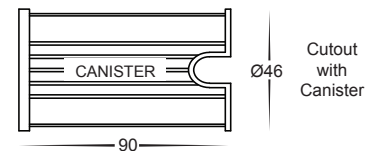
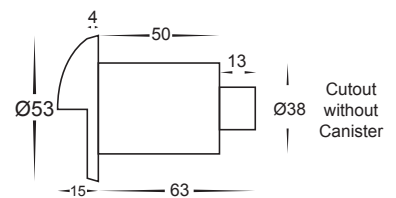

Mini Olo

- Mini recessed step light with eyelid
- 316 Stainless Steel, Solid Copper Or Black Face With Marine Grade 316 Stainless Steel Body
- Flush tempered glass
- Dimmable
- Face diameter: 53mm
- Installation depth: 90mm
- IP Rating: IP67
- Not suitable for inground installation



Solid Brass and Solid Copper fittings will naturally tarnish. Solid Brass fittings with additional coloured coatings (Antique Brass & Graphite) may tarnish through the coating when installed in outdoor environments.

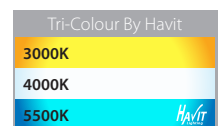

PART NUMBER	COLOUR TEMP	LUMENS	INPUT	INCLUDED LED
HV2891T-BLK-12V	3000K - 4000K - 5500K	80lm - 90lm - 85lm	12v DC	Tri-Colour Built in 1w
HV2891T-CP-12V	3000K - 4000K - 5500K	80lm - 90lm - 85lm	12v DC	Tri-Colour Built in 1w
HV2891T-SS316-12V	3000K - 4000K - 5500K	80lm - 90lm - 85lm	12v DC	Tri-Colour Built in 1w

See pages 295-306 for compatible drivers. All low voltage products that specify an input of 12v or 24v DC must be used with a suitable LED driver.



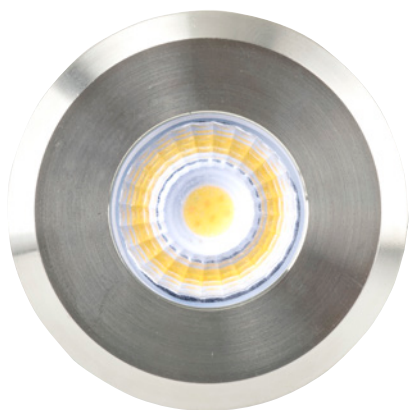

HV2892T-SS316-12V
Stainless Steel 316

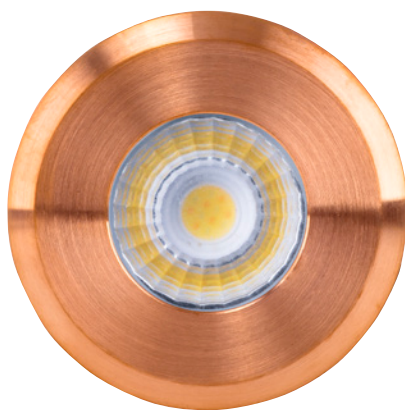

HV2892T-CP-12V
Solid Copper

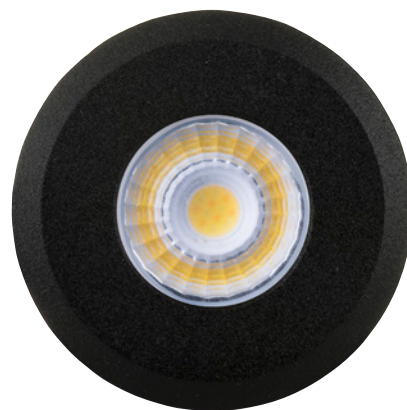

HV2892T-BLK-12V
Stainless Steel 316 Black



Weathered Copper



Cutout with Canister
— Ø46 —

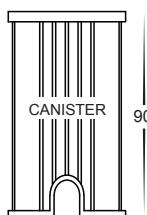

Cutout without Canister
— Ø38 —

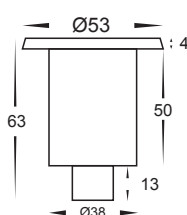

Mini Ollo

- Mini recessed inground/step light
- 316 Stainless Steel, Solid Copper Or Black Face With Marine Grade 316 Stainless Steel Body
- Flush tempered glass
- Dimmable
- Face diameter: 53mm
- Installation depth: 90mm
- Foot trafficable
- IP Rating: IP67
- NOTE: Adequate drainage must be allowed



Solid Brass and Solid Copper fittings will naturally tarnish. Solid Brass fittings with additional coloured coatings (Antique Brass & Graphite) may tarnish through the coating when installed in outdoor environments.

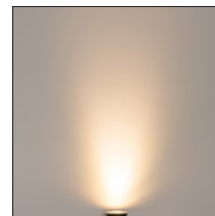
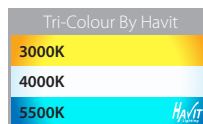

PART NUMBER	COLOUR TEMP	LUMENS	INPUT	INCLUDED LED
HV2892T-BLK-12V	3000K - 4000K - 5500K	80lm - 90lm - 85lm	12v DC	Tri-Colour Built in 1w
HV2892T-CP-12V	3000K - 4000K - 5500K	80lm - 90lm - 85lm	12v DC	Tri-Colour Built in 1w
HV2892T-SS316-12V	3000K - 4000K - 5500K	80lm - 90lm - 85lm	12v DC	Tri-Colour Built in 1w

See pages 295-306 for compatible drivers. All low voltage products that specify an input of 12v or 24v DC must be used with a suitable LED driver.



For detailed product specifications visit www.Havit.com.au or scan this QR code

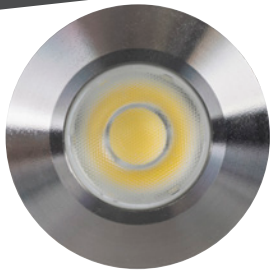

HV2893T-SS316-12V
Stainless Steel 316

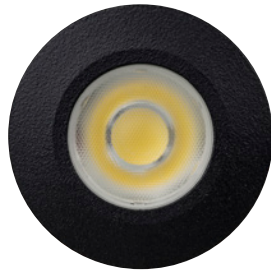

HV2893T-BLK-12V
Stainless Steel Black

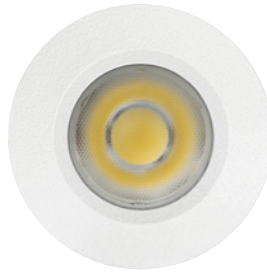

HV2893T-WHT-12V
Stainless Steel White



Cut Out With Canister
Ø38

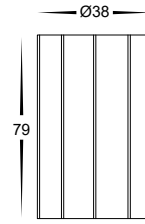

Cut Out Without Canister
Ø36

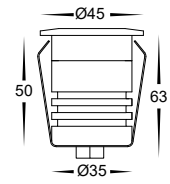

Dek

- Deck or Inground Light
- 316 Stainless Steel, 316 Stainless Steel Black or White Face
- Aluminium Body
- Dimmable
- IP Rating: IP67

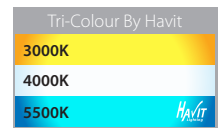

PART NUMBER	COLOUR TEMP	LUMENS	INPUT	INCLUDED LED
HV2893T-SS316-12V	3000K - 4000K - 5500K	180lm - 190lm - 185lm	12v DC	Tri-Colour Built in 3w
HV2893T-BLK-12V	3000K - 4000K - 5500K	180lm - 190lm - 185lm	12v DC	Tri-Colour Built in 3w
HV2893T-WHT-12V	3000K - 4000K - 5500K	180lm - 190lm - 185lm	12v DC	Tri-Colour Built in 3w

See pages 295-306 for compatible drivers. All low voltage products that specify an input of 12v or 24v DC must be used with a suitable LED driver.



HV2894T-BLK-12V
Aluminium Black



HV2894T-WHT-12V
Aluminium White



Cut Out With Canister
Ø38

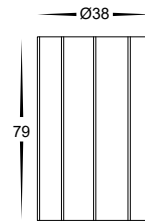

Cut Out Without Canister
Ø36

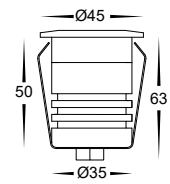

Brillo

- Wall or Inground Light
- Aluminium Poly Powder Coated Black or White
- Dimmable
- IP Rating: IP67

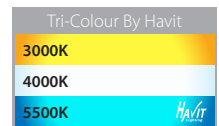

PART NUMBER	COLOUR TEMP	LUMENS	INPUT	INCLUDED LED
HV2894T-BLK-12V	3000K - 4000K - 5500K	60lm - 70lm - 65lm	12v DC	Tri-Colour Built in 3w
HV2894T-WHT-12V	3000K - 4000K - 5500K	60lm - 70lm - 65lm	12v DC	Tri-Colour Built in 3w

See pages 295-306 for compatible drivers. All low voltage products that specify an input of 12v or 24v DC must be used with a suitable LED driver.





HV2899NW-AB
Antique Brass



HV2899NW-BR
Brass



HV2899NW-BLK
Stainless Steel Black

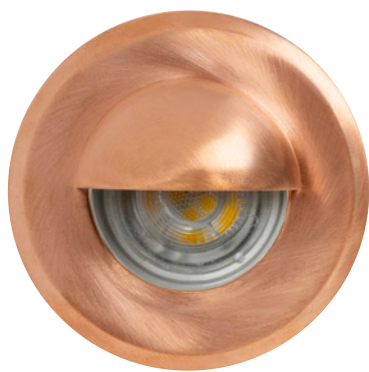

HV2899NW-CP
Copper



HV2899NW-SS316
Stainless Steel 316



Cut Out With Canister
Ø55

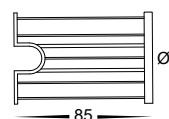

Cut Out Without Canister
Ø42

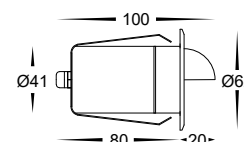

Lokk

- Wall Light with Eyelid
- 316 Stainless Steel, Copper, 316 Stainless Steel Black, Brass and Brass with Antique Brass Finish
- IP Rating: IP65



Solid Brass and Solid Copper fittings will naturally tarnish. Solid Brass fittings with additional coloured coatings (Antique Brass & Graphite) may tarnish through the coating when installed in outdoor environments.



PART NUMBER	COLOUR TEMP	LUMENS	INPUT	INCLUDED LED
HV2899NW-AB	3000K - 4000K	270lm - 300lm	12v DC	3w MR11 3000K LED + 3w MR11 4000K LED
HV2899NW-BR	3000K - 4000K	270lm - 300lm	12v DC	3w MR11 3000K LED + 3w MR11 4000K LED
HV2899NW-BLK	3000K - 4000K	270lm - 300lm	12v DC	3w MR11 3000K LED + 3w MR11 4000K LED
HV2899NW-CP	3000K - 4000K	270lm - 300lm	12v DC	3w MR11 3000K LED + 3w MR11 4000K LED
HV2899NW-SS316	3000K - 4000K	270lm - 300lm	12v DC	3w MR11 3000K LED + 3w MR11 4000K LED

See pages 295-306 for compatible drivers. All low voltage products that specify an input of 12v or 24v DC must be used with a suitable LED driver.



For detailed product specifications
visit www.Havit.com.au
or scan this QR code



**HV2901
HV2902
HV2903T
HV2904T**
316 Stainless Steel

**HV2901-AB
HV2902-AB
HV2903T-AB
HV2904T-AB**
Antique Brass

**HV2903T-BR
HV2904T-BR**
Solid Brass



HV2905T-12V
316 Stainless Steel

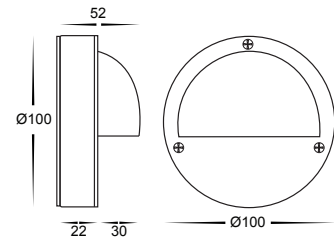
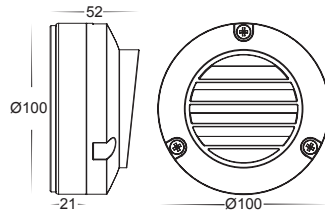

Pinta

- Surface mounted louvred & eyelid step light
- 316 Stainless Steel, Antique Brass and Solid Brass
- Tempered glass
- IP Rating: IP65

i Solid Brass and Solid Copper fittings will naturally tarnish. Solid Brass fittings with additional coloured coatings (Antique Brass & Graphite) may tarnish through the coating when installed in outdoor environments.

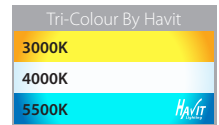

PART NUMBER	COLOUR TEMP	LUMENS	INPUT	INCLUDED LED
HV2901	NA	NA	240v	No globes supplied
HV2902	NA	NA	12v	No globes supplied
HV2903T	3000K - 4000K - 5500K	160lm - 170lm - 180lm	240v	Tri-Colour Built-in 2.3w LED
HV2904T	3000K - 4000K - 5500K	160lm - 170lm - 180lm	12v DC	Tri-Colour Built-in 2.3w LED
HV2901-AB	NA	NA	240v	No globes supplied
HV2902-AB	NA	NA	12v	No globes supplied
HV2903T-AB	3000K - 4000K - 5500K	160lm - 170lm - 180lm	240v	Tri-Colour Built-in 2.3w LED
HV2904T-AB	3000K - 4000K - 5500K	160lm - 170lm - 180lm	12v DC	Tri-Colour Built-in 2.3w LED
HV2903T-BR	3000K - 4000K - 5500K	160lm - 170lm - 180lm	240v	Tri-Colour Built-in 2.3w LED
HV2904T-BR	3000K - 4000K - 5500K	160lm - 170lm - 180lm	12v DC	Tri-Colour Built-in 2.3w LED
HV2905T-12V	3000K - 4000K - 5500K	160lm - 170lm - 180lm	12v DC	Tri-Colour Built-in 2.3w LED

HAVIT COMPATIBLE ACCESSORIES

HV9511W	Optional G9 LED globe to suit HV2901
HV9529-3.2W	Optional G4 LED globe to suit HV2902

See pages 295-306 for compatible drivers. All low voltage products that specify an input of 12v or 24v DC must be used with a suitable LED driver.





HV2906
HV2907
HV2908
HV2909
316 Stainless Steel

HV2916
HV2917
HV2918
HV2919
Copper

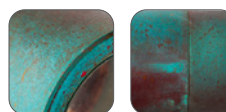
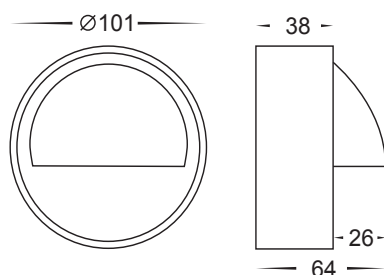

Weathered Copper

Pinta

- Surface mounted step light with eyelid
- Full body Stainless Steel 316 Marine Grade with Stainless Steel or Copper face
- Extra large eyelid design to maximise light output
- Frosted tempered glass
- IP Rating: IP54

i Solid Brass and Solid Copper fittings will naturally tarnish. Solid Brass fittings with additional coloured coatings (Antique Brass & Graphite) may tarnish through the coating when installed in outdoor environments.



PART NUMBER	COLOUR TEMP	LUMENS	INPUT	INCLUDED LED
HV2906	NA	NA	240v	No globes supplied
HV2907	NA	NA	12v	No globes supplied
HV2908C	5500K	180lm	240v	Built-in 2.3w
HV2908W	3000K	160lm	240v	Built-in 2.3w
HV2909C	5500K	180lm	12v DC	Built-in 2.3w
HV2909W	3000K	160lm	12v DC	Built-in 2.3w
HV2916	NA	NA	240v	No globes supplied
HV2917	NA	NA	12v	No globes supplied
HV2918C	5500K	180lm	240v	Built-in 2.3w
HV2918W	3000K	160lm	240v	Built-in 2.3w
HV2919C	5500K	180lm	12v DC	Built-in 2.3w
HV2919W	3000K	160lm	12v DC	Built-in 2.3w
HAVIT COMPATIBLE ACCESSORIES				
HV9511W	Optional G9 LED globe to suit HV2906 & HV2916			
HV9529-3.2W	Optional G4 LED globe to suit HV2907 & HV2917			

See pages 295-306 for compatible drivers. All low voltage products that specify an input of 12v or 24v DC must be used with a suitable LED driver.



For detailed product specifications visit www.Havit.com.au or scan this QR code



**HV2921
HV2922
HV2923T
HV2924T**
Aluminium Black



HV2925T-12V
Aluminium Black



**HV2923T-WHT
HV2924T-WHT**
Aluminium White



HV2925T-WHT-12V
Aluminium White

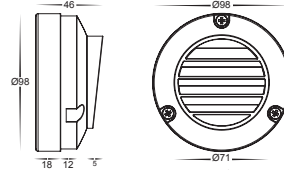
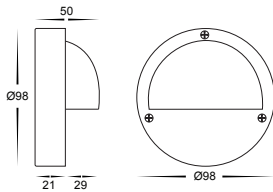

Pinta Aluminium

- Surface mounted eyelid & louvred step light
- Aluminium Poly Powder Coated Black or White.
- Tempered glass
- IP Rating: IP65

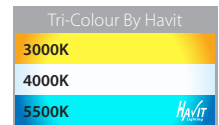

PART NUMBER	COLOUR TEMP	LUMENS	INPUT	INCLUDED LED
HV2921	NA	NA	240v	No globes supplied
HV2922	NA	NA	12v	No globes supplied
HV2923T	3000K - 4000K - 5500K	160lm - 170lm - 180lm	240v	Tri-Colour Built-in 2.3w LED
HV2923T-WHT	3000K - 4000K - 5500K	160lm - 170lm - 180lm	240v	Tri-Colour Built-in 2.3w LED
HV2924T	3000K - 4000K - 5500K	160lm - 170lm - 180lm	12v DC	Tri-Colour Built-in 2.3w LED
HV2924T-WHT	3000K - 4000K - 5500K	160lm - 170lm - 180lm	12v DC	Tri-Colour Built-in 2.3w LED
HV2925T-12V	3000K - 4000K - 5500K	160lm - 170lm - 180lm	12v DC	Tri-Colour Built-in 2.3w LED
HV2925T-WHT-12V	3000K - 4000K - 5500K	160lm - 170lm - 180lm	12v DC	Tri-Colour Built-in 2.3w LED

HAVIT COMPATIBLE ACCESSORIES

HV9511W	Optional G9 LED globe to suit HV2921
HV9529-3.2W	Optional G4 LED globe to suit HV2922

See pages 295-306 for compatible drivers. All low voltage products that specify an input of 12v or 24v DC must be used with a suitable LED driver.





HV2960-TTM
Aluminium Titanium



HV2960-BLK
Aluminium Black

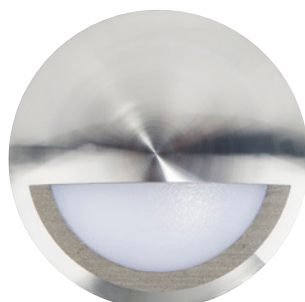

HV2961-TTM
Aluminium Titanium



HV2961-BLK
Aluminium Black

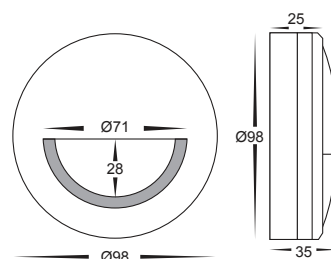
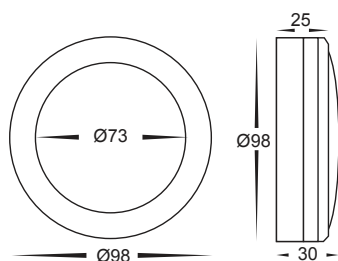

Nava Aluminium

- Step or Wall Light with or Without Eyelid
- Aluminium Poly Powder Coated Black or Coloured Titanium
- IP Rating: IP65
- IK Rating: IK08

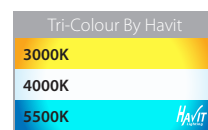

PART NUMBER	COLOUR TEMP	LUMENS	INPUT	INCLUDED LED
HV2960T-TTM-12V	3000k - 4000k - 5500k	360lm - 380lm - 400lm	12V DC	Tri Colour 5w Built in LED
HV2960T-TTM-240V	3000k - 4000k - 5500k	360lm - 380lm - 400lm	240V	Tri Colour 5w Built in LED
HV2960T-BLK-12V	3000k - 4000k - 5500k	360lm - 380lm - 400lm	12V DC	Tri Colour 5w Built in LED
HV2960T-BLK-240V	3000k - 4000k - 5500k	360lm - 380lm - 400lm	240V	Tri Colour 5w Built in LED
HV2961T-TTM-12V	3000k - 4000k - 5500k	360lm - 380lm - 400lm	12V DC	Tri Colour 5w Built in LED
HV2961T-TTM-240V	3000k - 4000k - 5500k	360lm - 380lm - 400lm	240V	Tri Colour 5w Built in LED
HV2961T-BLK-12V	3000k - 4000k - 5500k	360lm - 380lm - 400lm	12V DC	Tri Colour 5w Built in LED
HV2961T-BLK-240V	3000k - 4000k - 5500k	360lm - 380lm - 400lm	240V	Tri Colour 5w Built in LED

See pages 295-306 for compatible drivers. All low voltage products that specify an input of 12v or 24v DC must be used with a suitable LED driver.



For detailed product specifications
visit www.Havit.com.au
or scan this QR code



HV2927T-BLK-12V
HV2927T-BLK-240V



HV2928T-BLK-12V
HV2928T-BLK-240V



HV2929T-BLK-12V
HV2929T-BLK-240V

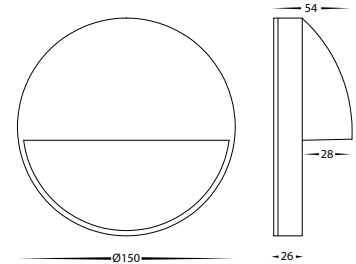
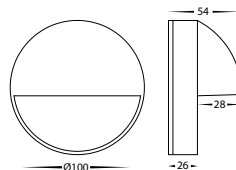
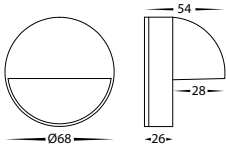

Veko

- Step or Wall Light with Eyelid
- Aluminium Poly Powder Coated Black
- IP Rating: IP65
- IK Rating: IK08

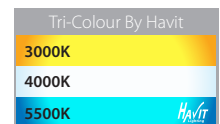

PART NUMBER	COLOUR TEMP	LUMENS	INPUT	INCLUDED LED
HV2927T-BLK-12V	3000K - 4000K - 5500K	100lm - 110lm - 105lm	12v DC	Tri Colour 2w Built in LED
HV2927T-BLK-240V	3000K - 4000K - 5500K	100lm - 110lm - 105lm	12v DC	Tri Colour 2w Built in LED
HV2928T-BLK-12V	3000K - 4000K - 5500K	300lm - 310lm - 305lm	12v DC	Tri Colour 6w Built in LED
HV2928T-BLK-240V	3000K - 4000K - 5500K	300lm - 310lm - 305lm	12v DC	Tri Colour 6w Built in LED
HV2929T-BLK-12V	3000K - 4000K - 5500K	500lm - 510lm - 505lm	12v DC	Tri Colour 10w Built in LED
HV2929T-BLK-240V	3000K - 4000K - 5500K	500lm - 510lm - 505lm	12v DC	Tri Colour 10w Built in LED

See pages 295-306 for compatible drivers. All low voltage products that specify an input of 12v or 24v DC must be used with a suitable LED driver.





HV2927T-WHT-12V
HV2927T-WHT-240V



HV2928T-WHT-12V
HV2928T-WHT-240V



HV2929T-WHT-12V
HV2929T-WHT-240V

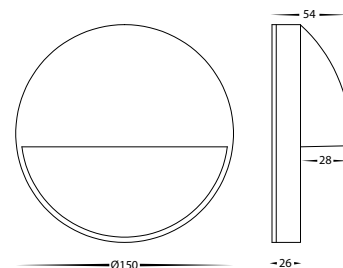
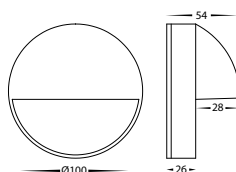
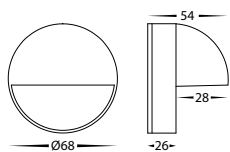

Veko

- Step or Wall Light with Eyelid
- Aluminium Poly Powder Coated White
- IP Rating: IP65
- IK Rating: IK08

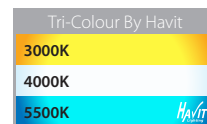

PART NUMBER	COLOUR TEMP	LUMENS	INPUT	INCLUDED LED
HV2927T-WHT-12V	3000K - 4000K - 5500K	100lm - 110lm - 105lm	12v DC	Tri Colour 2w Built in LED
HV2927T-WHT-240V	3000K - 4000K - 5500K	100lm - 110lm - 105lm	12v DC	Tri Colour 2w Built in LED
HV2928T-WHT-12V	3000K - 4000K - 5500K	300lm - 310lm - 305lm	12v DC	Tri Colour 6w Built in LED
HV2928T-WHT-240V	3000K - 4000K - 5500K	300lm - 310lm - 305lm	12v DC	Tri Colour 6w Built in LED
HV2929T-WHT-12V	3000K - 4000K - 5500K	500lm - 510lm - 505lm	12v DC	Tri Colour 10w Built in LED
HV2929T-WHT-240V	3000K - 4000K - 5500K	500lm - 510lm - 505lm	12v DC	Tri Colour 10w Built in LED

See pages 295-306 for compatible drivers. All low voltage products that specify an input of 12v or 24v DC must be used with a suitable LED driver.



For detailed product specifications
visit www.Havit.com.au
or scan this QR code



HV2927T-BR-12V
HV2927T-BR-240V



HV2928T-BR-12V
HV2928T-BR-240V



HV2929T-BR-12V
HV2929T-BR-240V

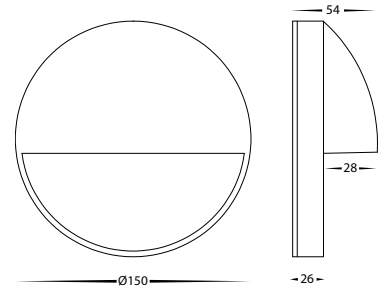
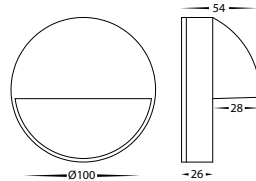
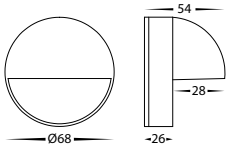

Veko

- Step or Wall Light with Eyelid
- Solid Brass
- IP Rating: IP65
- IK Rating: IK08

i Solid Brass and Solid Copper fittings will naturally tarnish. Solid Brass fittings with additional coloured coatings (Antique Brass & Graphite) may tarnish through the coating when installed in outdoor environments.

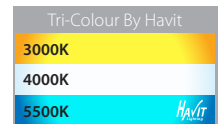

PART NUMBER	COLOUR TEMP	LUMENS	INPUT	INCLUDED LED
HV2927T-BR-12V	3000K - 4000K - 5500K	100lm - 110lm - 105lm	12v DC	Tri Colour 2w Built in LED
HV2927T-BR-240V	3000K - 4000K - 5500K	100lm - 110lm - 105lm	12v DC	Tri Colour 2w Built in LED
HV2928T-BR-12V	3000K - 4000K - 5500K	300lm - 310lm - 305lm	12v DC	Tri Colour 6w Built in LED
HV2928T-BR-240V	3000K - 4000K - 5500K	300lm - 310lm - 305lm	12v DC	Tri Colour 6w Built in LED
HV2929T-BR-12V	3000K - 4000K - 5500K	500lm - 510lm - 505lm	12v DC	Tri Colour 10w Built in LED
HV2929T-BR-240V	3000K - 4000K - 5500K	500lm - 510lm - 505lm	12v DC	Tri Colour 10w Built in LED

See pages 295-306 for compatible drivers. All low voltage products that specify an input of 12v or 24v DC must be used with a suitable LED driver.





HV2927T-SS316-12V
HV2927T-SS316-240V



HV2928T-SS316-12V
HV2928T-SS316-240V



HV2929T-SS316-12V
HV2929T-SS316-240V

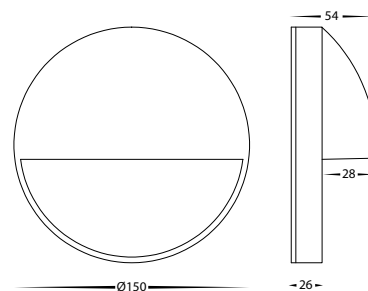
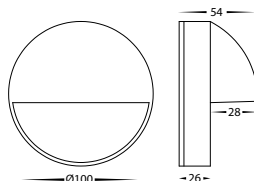
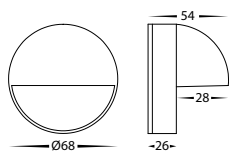

Veko

- Step or Wall Light with Eyelid
- 316 Stainless Steel
- IP Rating: IP65
- IK Rating: IK08

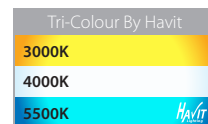

PART NUMBER	COLOUR TEMP	LUMENS	INPUT	INCLUDED LED
HV2927T-SS316-12V	3000K - 4000K - 5500K	100lm - 110lm - 105lm	12v DC	Tri Colour 2w Built in LED
HV2927T-SS316-240V	3000K - 4000K - 5500K	100lm - 110lm - 105lm	12v DC	Tri Colour 2w Built in LED
HV2928T-SS316-12V	3000K - 4000K - 5500K	300lm - 310lm - 305lm	12v DC	Tri Colour 6w Built in LED
HV2928T-SS316-240V	3000K - 4000K - 5500K	300lm - 310lm - 305lm	12v DC	Tri Colour 6w Built in LED
HV2929T-SS316-12V	3000K - 4000K - 5500K	500lm - 510lm - 505lm	12v DC	Tri Colour 10w Built in LED
HV2929T-SS316-240V	3000K - 4000K - 5500K	500lm - 510lm - 505lm	12v DC	Tri Colour 10w Built in LED

See pages 295-306 for compatible drivers. All low voltage products that specify an input of 12v or 24v DC must be used with a suitable LED driver.



For detailed product specifications
visit www.Havit.com.au
or scan this QR code

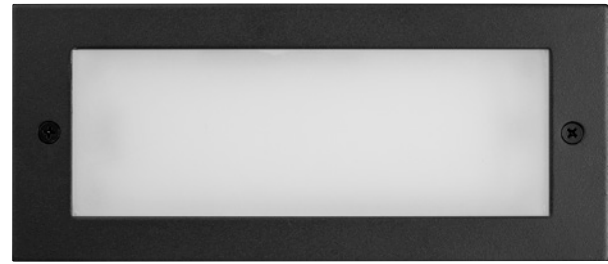
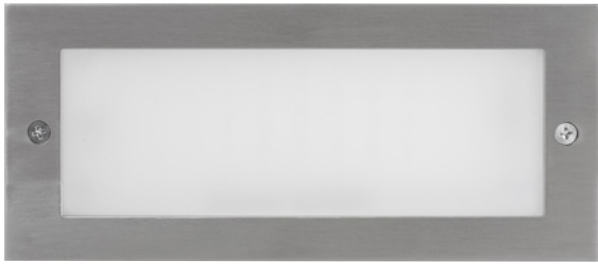

HV3003T-SS316-240V
HV3003T-SS316-12V
316 Stainless Steel

HV3003T-BLK-240V
HV3003T-BLK-12V
Stainless Steel Black

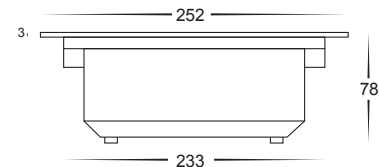
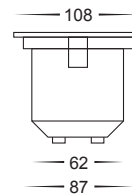
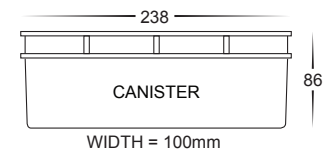
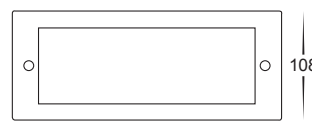

HV3003T-WHT-240V
HV3003T-WHT-12V
Stainless Steel White

Bata Stainless Steel

- Brick light with plain face
- Stainless Steel 316 Marine Grade Cover And Stainless Steel Poly Powder Coated Black or White Cover
- Powder coated die cast aluminium body
- Cutout with Canister: 238mm x 100mm
- Installation Depth: 90mm
- Frosted tempered glass
- IP Rating: IP54

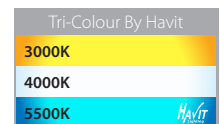

PART NUMBER	COLOUR TEMP	LUMENS	INPUT	INCLUDED LED
HV3003T-SS316-240V	3000K - 4000K - 5500K	800lm - 850lm - 900lm	240v	Tri-Colour Built-in 10w LED
HV3003T-SS316-12V	3000K - 4000K - 5500K	800lm - 850lm - 900lm	12v DC	Tri-Colour Built-in 10w LED
HV3003T-BLK-240V	3000K - 4000K - 5500K	800lm - 850lm - 900lm	240v	Tri-Colour Built-in 10w LED
HV3003T-BLK-12V	3000K - 4000K - 5500K	800lm - 850lm - 900lm	12v DC	Tri-Colour Built-in 10w LED
HV3003T-WHT-240V	3000K - 4000K - 5500K	800lm - 850lm - 900lm	240v	Tri-Colour Built-in 10w LED
HV3003T-WHT-12V	3000K - 4000K - 5500K	800lm - 850lm - 900lm	12v DC	Tri-Colour Built-in 10w LED

See pages 295-306 for compatible drivers. All low voltage products that specify an input of 12v or 24v DC must be used with a suitable LED driver.



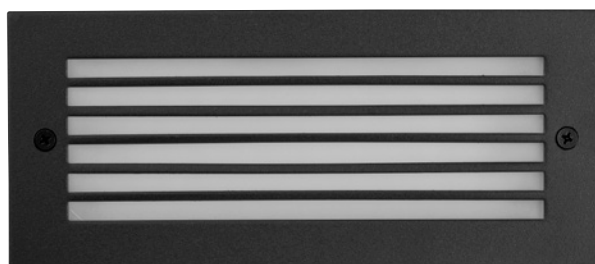
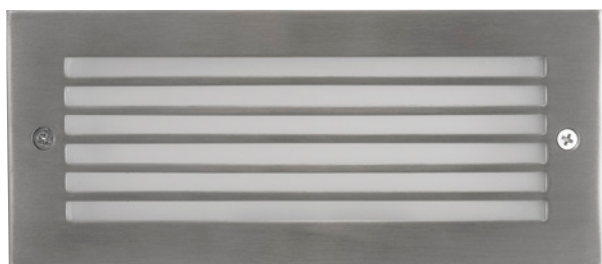

HV3004T-SS316-240V
HV3004T-SS316-12V
316 Stainless Steel

HV3004T-BLK-240V
HV3004T-BLK-12V
Stainless Steel Black



HV3004T-WHT-240V
HV3004T-WHT-12V
Stainless Steel White

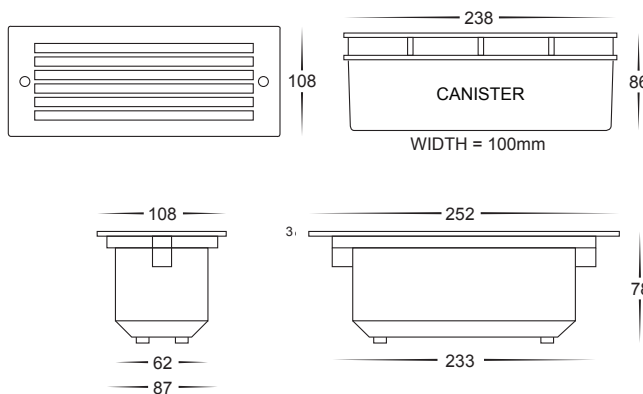

Bata Stainless Steel

- Brick light with grill cover
- Stainless Steel 316 Marine Grade Cover And Stainless Steel Poly Powder Coated Black or White Cover
- Powder coated die cast aluminium body
- Cutout with Canister: 238mm x 100mm
- Installation Depth: 90mm
- Frosted tempered glass
- IP Rating: IP54

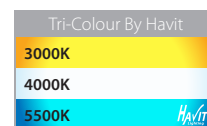

PART NUMBER	COLOUR TEMP	LUMENS	INPUT	INCLUDED LED
HV3004T-SS316-240V	3000K - 4000K - 5500K	800lm - 850lm - 900lm	240v	Tri-Colour Built-in 10w LED
HV3004T-SS316-12V	3000K - 4000K - 5500K	800lm - 850lm - 900lm	12v DC	Tri-Colour Built-in 10w LED
HV3004T-BLK-240V	3000K - 4000K - 5500K	800lm - 850lm - 900lm	240v	Tri-Colour Built-in 10w LED
HV3004T-BLK-12V	3000K - 4000K - 5500K	800lm - 850lm - 900lm	12v DC	Tri-Colour Built-in 10w LED
HV3004T-WHT-240V	3000K - 4000K - 5500K	800lm - 850lm - 900lm	240v	Tri-Colour Built-in 10w LED
HV3004T-WHT-12V	3000K - 4000K - 5500K	800lm - 850lm - 900lm	12v DC	Tri-Colour Built-in 10w LED

See pages 295-306 for compatible drivers. All low voltage products that specify an input of 12v or 24v DC must be used with a suitable LED driver.



For detailed product specifications
 visit www.Havit.com.au
 or scan this QR code

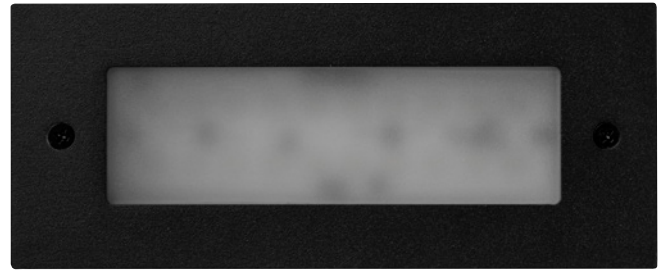
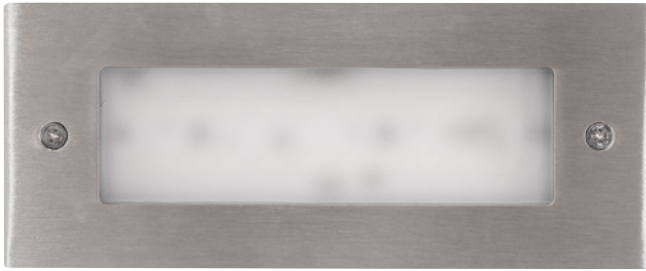

HV3005T-SS316-240V
HV3005T-SS316-12V
316 Stainless Steel

HV3005T-BLK-240V
HV3005T-BLK-12V
Stainless Steel Black

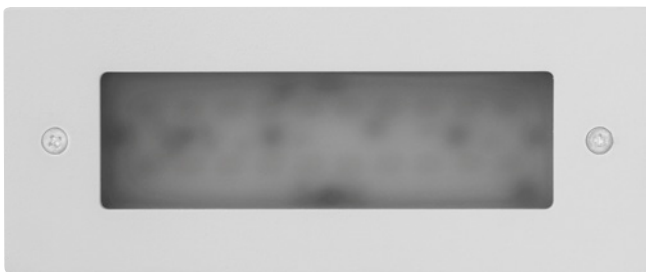

HV3005T-WHT-240V
HV3005T-WHT-12V
Stainless Steel White

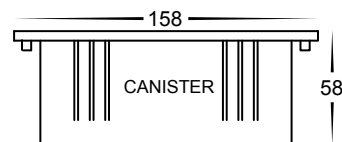
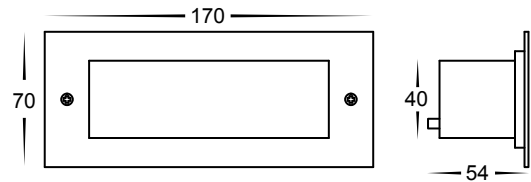

Width = 56mm

Bata Stainless Steel

- Brick light with plain face
- Stainless Steel 316 Marine Grade Cover And Stainless Steel Poly Powder Coated Black or White Cover
- Powder coated die cast aluminium body
- Cutout with Canister: 158mm x 56mm
- Installation Depth: 60mm
- Frosted tempered glass
- IP Rating: IP54

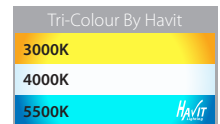

PART NUMBER	COLOUR TEMP	LUMENS	INPUT	INCLUDED LED
HV3005T-SS316-12V	3000K - 4000K - 5500K	480lm - 510lm - 540lm	12v DC	Tri-Colour Built in 6w
HV3005T-SS316-240V	3000K - 4000K - 5500K	480lm - 510lm - 540lm	240V AC	Tri-Colour Built in 6w
HV3005T-BLK-12V	3000K - 4000K - 5500K	480lm - 510lm - 540lm	12v DC	Tri-Colour Built in 6w
HV3005T-BLK-240V	3000K - 4000K - 5500K	480lm - 510lm - 540lm	240V AC	Tri-Colour Built in 6w
HV3005T-WHT-12V	3000K - 4000K - 5500K	480lm - 510lm - 540lm	12v DC	Tri-Colour Built in 6w
HV3005T-WHT-240V	3000K - 4000K - 5500K	480lm - 510lm - 540lm	240V AC	Tri-Colour Built in 6w

See pages 295-306 for compatible drivers. All low voltage products that specify an input of 12v or 24v DC must be used with a suitable LED driver.



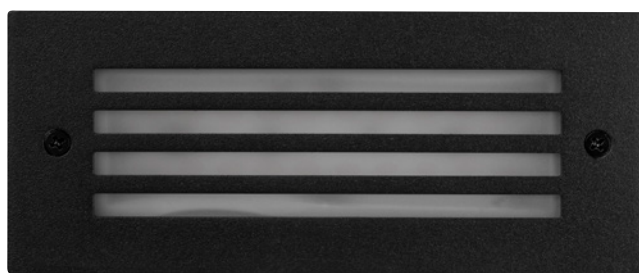
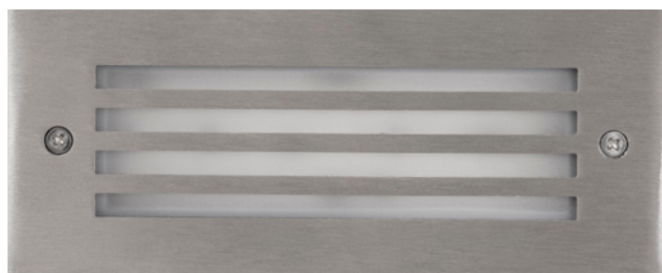

HV3006T-SS316-240V
HV3006T-SS316-12V
316 Stainless Steel

HV3006T-BLK-240V
HV3006T-BLK-12V
Stainless Steel Black



HV3006T-WHT-240V
HV3006T-WHT-12V
Stainless Steel White

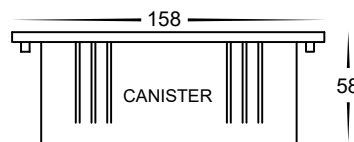
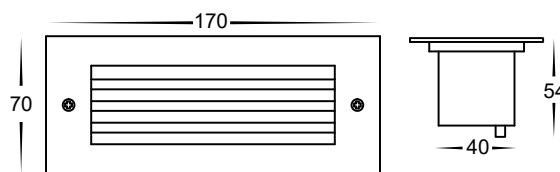

Width = 56mm

Bata Stainless Steel

- Brick light with grill cover
- Stainless Steel 316 Marine Grade Cover And Stainless Steel Poly Powder Coated Black or White Cover
- Powder coated die cast aluminium body
- Cutout with Canister: 158mm x 56mm
- Installation Depth: 60mm
- Frosted tempered glass
- IP Rating: IP54

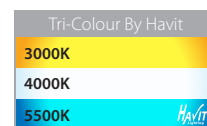

PART NUMBER	COLOUR TEMP	LUMENS	INPUT	INCLUDED LED
HV3006T-SS316-12V	3000K - 4000K - 5500K	480lm - 510lm - 540lm	12v DC	Tri-Colour Built in 6w
HV3006T-SS316-240V	3000K - 4000K - 5500K	480lm - 510lm - 540lm	240V AC	Tri-Colour Built in 6w
HV3006T-BLK-12V	3000K - 4000K - 5500K	480lm - 510lm - 540lm	12v DC	Tri-Colour Built in 6w
HV3006T-BLK-240V	3000K - 4000K - 5500K	480lm - 510lm - 540lm	240V AC	Tri-Colour Built in 6w
HV3006T-WHT-12V	3000K - 4000K - 5500K	480lm - 510lm - 540lm	12v DC	Tri-Colour Built in 6w
HV3006T-WHT-240V	3000K - 4000K - 5500K	480lm - 510lm - 540lm	240V AC	Tri-Colour Built in 6w

See pages 295-306 for compatible drivers. All low voltage products that specify an input of 12v or 24v DC must be used with a suitable LED driver.



For detailed product specifications
 visit www.Havit.com.au
 or scan this QR code



HV3007T-SS316-240V
HV3007T-SS316-12V
316 Stainless Steel

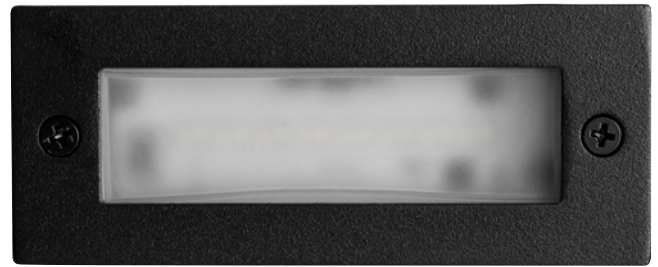

HV3007T-BLK-240V
HV3007T-BLK-12V
Stainless Steel Black



HV3007T-WHT-240V
HV3007T-WHT-12V
Stainless Steel White

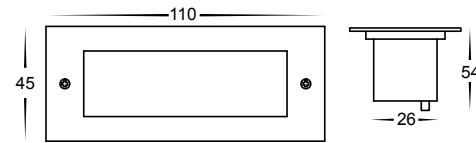
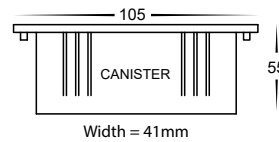

Bata Stainless Steel

- Brick light with plain face
- Stainless Steel 316 Marine Grade Cover And Stainless Steel Poly Powder Coated Black or White Cover
- Powder coated die cast aluminium body
- Cutout with Canister: 105mm x 41mm
- Installation Depth: 58mm
- Frosted tempered glass
- IP Rating: IP54

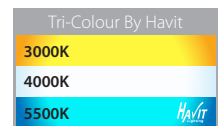

PART NUMBER	COLOUR TEMP	LUMENS	INPUT	INCLUDED LED
HV3007T-SS316-12V	3000K - 4000K - 5500K	240lm - 255lm - 270lm	12v DC	Tri-Colour Built in 3w
HV3007T-SS316-240V	3000K - 4000K - 5500K	240lm - 255lm - 270lm	240V AC	Tri-Colour Built in 3w
HV3007T-BLK-12V	3000K - 4000K - 5500K	240lm - 255lm - 270lm	12v DC	Tri-Colour Built in 3w
HV3007T-BLK-240V	3000K - 4000K - 5500K	240lm - 255lm - 270lm	240V AC	Tri-Colour Built in 3w
HV3007T-WHT-12V	3000K - 4000K - 5500K	240lm - 255lm - 270lm	12v DC	Tri-Colour Built in 3w
HV3007T-WHT-240V	3000K - 4000K - 5500K	240lm - 255lm - 270lm	240V AC	Tri-Colour Built in 3w

See pages 295-306 for compatible drivers. All low voltage products that specify an input of 12v or 24v DC must be used with a suitable LED driver.





HV3008T-SS316-240V
HV3008T-SS316-12V
 316 Stainless Steel

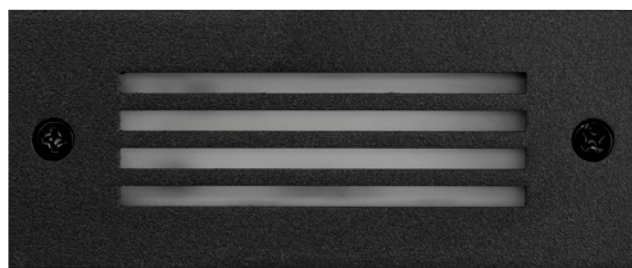

HV3008T-BLK-240V
HV3008T-BLK-12V
 Stainless Steel Black

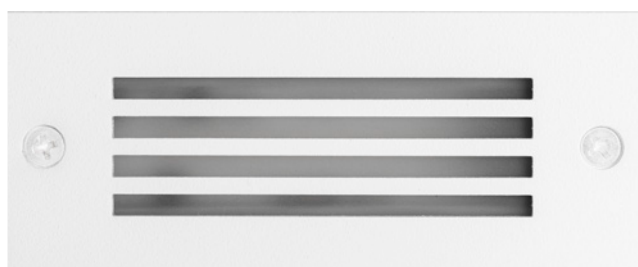

HV3008T-WHT-240V
HV3008T-WHT-12V
 Stainless Steel White

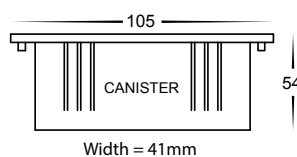
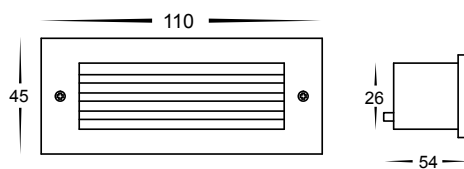

Bata Stainless Steel

- Brick light with grill cover
- Stainless Steel 316 Marine Grade Cover And Stainless Steel Poly Powder Coated Black or White Cover
- Powder coated die cast aluminium body
- Cutout with Canister: 105mm x 41mm
- Installation Depth: 58mm
- Frosted tempered glass
- IP Rating: IP54

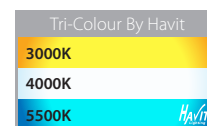

PART NUMBER	COLOUR TEMP	LUMENS	INPUT	INCLUDED LED
HV3008T-SS316-12V	3000K - 4000K - 5500K	240lm - 255lm - 270lm	12v DC	Tri-Colour Built in 3w
HV3008T-SS316-240V	3000K - 4000K - 5500K	240lm - 255lm - 270lm	240V AC	Tri-Colour Built in 3w
HV3008T-BLK-12V	3000K - 4000K - 5500K	240lm - 255lm - 270lm	12v DC	Tri-Colour Built in 3w
HV3008T-BLK-240V	3000K - 4000K - 5500K	240lm - 255lm - 270lm	240V AC	Tri-Colour Built in 3w
HV3008T-WHT-12V	3000K - 4000K - 5500K	240lm - 255lm - 270lm	12v DC	Tri-Colour Built in 3w
HV3008T-WHT-240V	3000K - 4000K - 5500K	240lm - 255lm - 270lm	240V AC	Tri-Colour Built in 3w

See pages 295-306 for compatible drivers. All low voltage products that specify an input of 12v or 24v DC must be used with a suitable LED driver.



For detailed product specifications
 visit www.Havit.com.au
 or scan this QR code





HV3105T-BLK-240V
HV3105T-BLK-12V



HV3105T-WHT-240V
HV3105T-WHT-12V

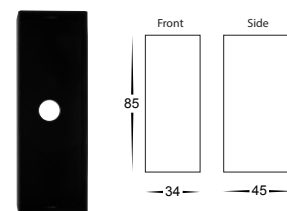
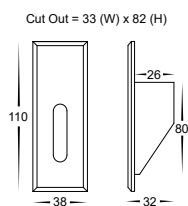

HV3105-CAN



HV3106T-BLK-240V
HV3106T-BLK-12V



HV3106T-WHT-240V
HV3106T-WHT-12V

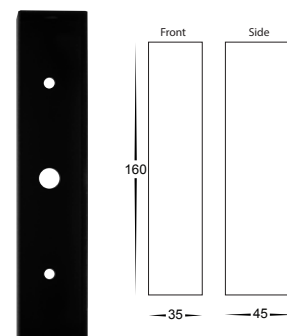
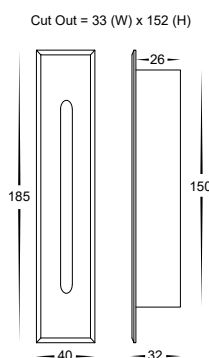

HV3106-CAN

Paso

- Recessed Wall Lights
- Aluminium Black and White
- Dimmable
- IP Rating: IP20



PART NUMBER	COLOUR TEMP	LUMENS	INPUT	INCLUDED LED
HV3105T-BLK-240V	3000K - 4000K - 5500K	45lm - 55lm - 49lm	240V - Remote LED Driver	Tri-Colour Built in 3w
HV3105T-BLK-12V	3000K - 4000K - 5500K	45lm - 55lm - 49lm	12V DC	Tri-Colour Built in 3w
HV3105T-WHT-240V	3000K - 4000K - 5500K	45lm - 55lm - 49lm	240V - Remote LED Driver	Tri-Colour Built in 3w
HV3105T-WHT-12V	3000K - 4000K - 5500K	45lm - 55lm - 49lm	12V DC	Tri-Colour Built in 3w
HV3106T-BLK-240V	3000K - 4000K - 5500K	45lm - 55lm - 49lm	240V - Remote LED Driver	Tri-Colour Built in 3w
HV3106T-BLK-12V	3000K - 4000K - 5500K	45lm - 55lm - 49lm	12V DC	Tri-Colour Built in 3w
HV3106T-WHT-240V	3000K - 4000K - 5500K	45lm - 55lm - 49lm	240V - Remote LED Driver	Tri-Colour Built in 3w
HV3106T-WHT-12V	3000K - 4000K - 5500K	45lm - 55lm - 49lm	12V DC	Tri-Colour Built in 3w
HAVIT COMPATIBLE ACCESSORIES				
HV3105-CAN	Canister to suit 12v DC Models			
HV3106-CAN	Canister to suit 12v DC Models			

See pages 295-306 for compatible drivers. All low voltage products that specify an input of 12v or 24v DC must be used with a suitable LED driver.



For detailed product specifications
visit www.Havit.com.au
or scan this QR code



HV3205T-SS316-12V
316 Stainless Steel



HV3205T-WHT-12V
Aluminium White



HV3205T-BLK-12V
Aluminium Black



HV3205T-AB-12V
Antique Brass



HV3205T-BR-12V
Solid Brass

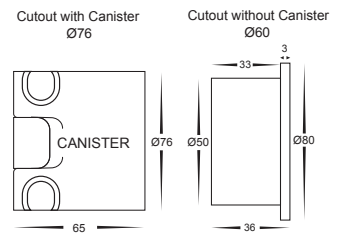

Reces

- Recessed round step light
- 316 Stainless Steel, Antique Brass, Solid Brass, Aluminium Poly Powder Coated Black or White
- Installation depth: 65mm
- 40° beam angle
- Dimmable
- IP Rating: IP67



i Solid Brass and Solid Copper fittings will naturally tarnish. Solid Brass fittings with additional coloured coatings (Antique Brass & Graphite) may tarnish through the coating when installed in outdoor environments.

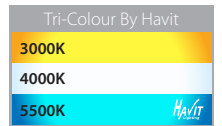

PART NUMBER	COLOUR TEMP	LUMENS	INPUT	INCLUDED LED
HV3205T-SS316-12V	3000K - 4000K - 5500K	180lm - 185lm - 190lm	12v DC	Tri-Colour Built in 2.5w LED
HV3205T-WHT-12V	3000K - 4000K - 5500K	180lm - 185lm - 190lm	12v DC	Tri-Colour Built in 2.5w LED
HV3205T-BLK-12V	3000K - 4000K - 5500K	180lm - 185lm - 190lm	12v DC	Tri-Colour Built in 2.5w LED
HV3205T-AB-12V	3000K - 4000K - 5500K	180lm - 185lm - 190lm	12v DC	Tri-Colour Built in 2.5w LED
HV3205T-BR-12V	3000K - 4000K - 5500K	180lm - 185lm - 190lm	12v DC	Tri-Colour Built in 2.5w LED

See pages 295-306 for compatible drivers. All low voltage products that specify an input of 12v or 24v DC must be used with a suitable LED driver.





HV3206T-SS316-12V
316 Stainless Steel



HV3206T-WHT-12V
Aluminium White



HV3206T-BLK-12V
Aluminium Black

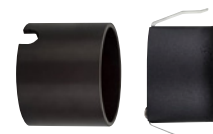

HV3206T-AB-12V
Antique Brass



HV3206T-BR-12V
Solid Brass

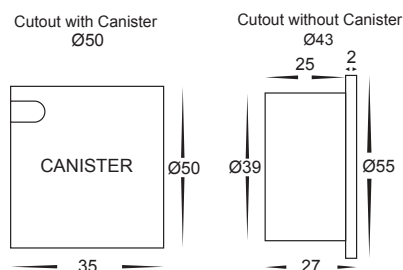

Mini Recess

- Recessed round step light
- 316 Stainless Steel, Antique Brass, Solid Brass, Aluminium Poly Powder Coated Black or White
- Installation depth: 40mm
- 40° beam angle
- Dimmable
- IP Rating: IP67



i Solid Brass and Solid Copper fittings will naturally tarnish. Solid Brass fittings with additional coloured coatings (Antique Brass & Graphite) may tarnish through the coating when installed in outdoor environments.

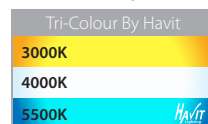

PART NUMBER	COLOUR TEMP	LUMENS	INPUT	INCLUDED LED
HV3206T-SS316-12V	3000K - 4000K - 5500K	55lm - 57lm - 60lm	12v DC	Tri-Colour Built in 1w LED
HV3206T-WHT-12V	3000K - 4000K - 5500K	55lm - 57lm - 60lm	12v DC	Tri-Colour Built in 1w LED
HV3206T-BLK-12V	3000K - 4000K - 5500K	55lm - 57lm - 60lm	12v DC	Tri-Colour Built in 1w LED
HV3206T-AB-12V	3000K - 4000K - 5500K	55lm - 57lm - 60lm	12v DC	Tri-Colour Built in 1w LED
HV3206T-BR-12V	3000K - 4000K - 5500K	55lm - 57lm - 60lm	12v DC	Tri-Colour Built in 1w LED

See pages 295-306 for compatible drivers. All low voltage products that specify an input of 12v or 24v DC must be used with a suitable LED driver.



For detailed product specifications visit www.Havit.com.au or scan this QR code



HV3215T-SS316-12V
316 Stainless Steel



HV3215T-WHT-12V
Aluminium White

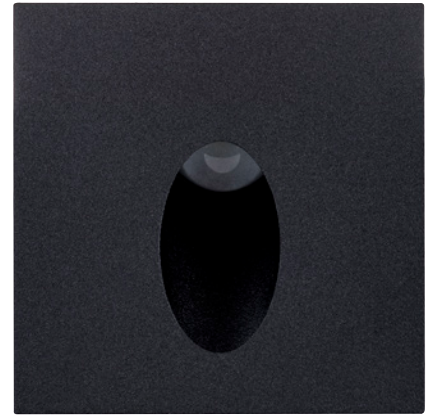

HV3215T-BLK-12V
Aluminium Black



HV3215T-AB-12V
Antique Brass



HV3215T-BR-12V
Solid Brass

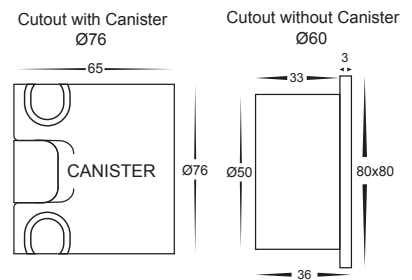

Reces

- Recessed square step light
- 316 Stainless Steel, Antique Brass, Solid Brass, Aluminium Poly Powder Coated Black or White
- Installation depth: 65mm
- 40° beam angle
- IP Rating: IP67
- Dimmable



i Solid Brass and Solid Copper fittings will naturally tarnish. Solid Brass fittings with additional coloured coatings (Antique Brass & Graphite) may tarnish through the coating when installed in outdoor environments.

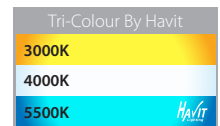

PART NUMBER	COLOUR TEMP	LUMENS	INPUT	INCLUDED LED
HV3215T-SS316-12V	3000K - 4000K - 5500K	180lm - 185lm - 190lm	12v DC	Tri-Colour Built in 2.5w LED
HV3215T-WHT-12V	3000K - 4000K - 5500K	180lm - 185lm - 190lm	12v DC	Tri-Colour Built in 2.5w LED
HV3215T-BLK-12V	3000K - 4000K - 5500K	180lm - 185lm - 190lm	12v DC	Tri-Colour Built in 2.5w LED
HV3215T-AB-12V	3000K - 4000K - 5500K	180lm - 185lm - 190lm	12v DC	Tri-Colour Built in 2.5w LED
HV3215T-BR-12V	3000K - 4000K - 5500K	180lm - 185lm - 190lm	12v DC	Tri-Colour Built in 2.5w LED

See pages 295-306 for compatible drivers. All low voltage products that specify an input of 12v or 24v DC must be used with a suitable LED driver.





HV3216T-SS316-12V
316 Stainless Steel



HV3216T-WHT-12V
Aluminium White

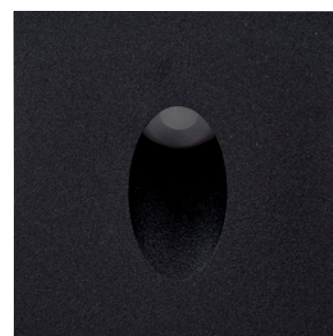

HV3216T-BLK-12V
Aluminium Black

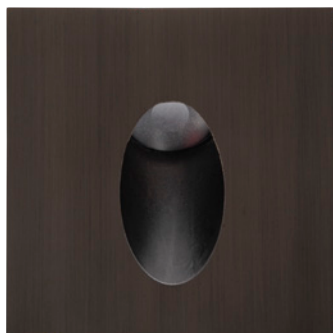

HV3216T-AB-12V
Antique Brass



HV3216T-BR-12V
Solid Brass

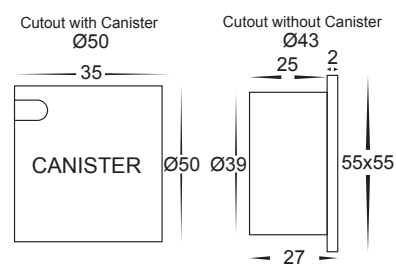
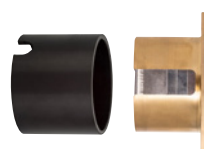

Mini Recess

- Recessed square step light
- 316 Stainless Steel, Antique Brass, Solid Brass, Aluminium Poly Powder Coated Black or White
- Installation depth: 40mm
- 40° beam angle
- IP Rating: IP67
- Dimmable



i Solid Brass and Solid Copper fittings will naturally tarnish. Solid Brass fittings with additional coloured coatings (Antique Brass & Graphite) may tarnish through the coating when installed in outdoor environments.

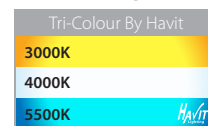

PART NUMBER	COLOUR TEMP	LUMENS	INPUT	INCLUDED LED
HV3216T-SS316-12V	3000K - 4000K - 5500K	55lm - 57lm - 60lm	12v DC	Tri-Colour Built in 1w LED
HV3216T-WHT-12V	3000K - 4000K - 5500K	55lm - 57lm - 60lm	12v DC	Tri-Colour Built in 1w LED
HV3216T-BLK-12V	3000K - 4000K - 5500K	55lm - 57lm - 60lm	12v DC	Tri-Colour Built in 1w LED
HV3216T-AB-12V	3000K - 4000K - 5500K	55lm - 57lm - 60lm	12v DC	Tri-Colour Built in 1w LED
HV3216T-BR-12V	3000K - 4000K - 5500K	55lm - 57lm - 60lm	12v DC	Tri-Colour Built in 1w LED

See pages 295-306 for compatible drivers. All low voltage products that specify an input of 12v or 24v DC must be used with a suitable LED driver.



For detailed product specifications visit www.Havit.com.au or scan this QR code



HV3221T-BLK



HV3222T-BLK

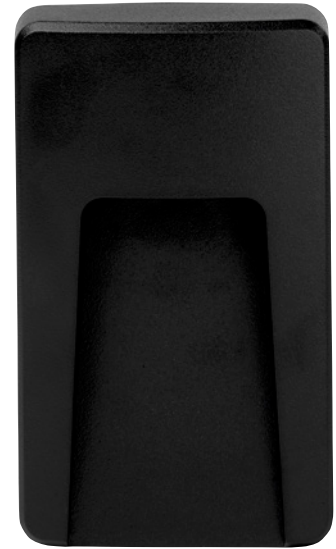

HV3223T-BLK

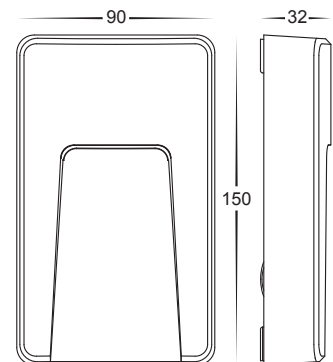
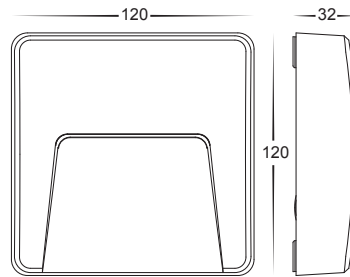
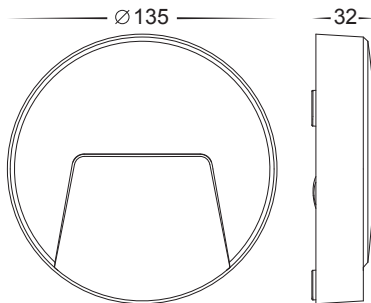

Seefore Black

- Surface mounted step light
- Polycarbonate Black
- IP Rating: IP65

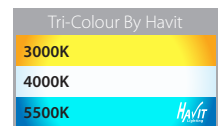

PART NUMBER	COLOUR TEMP	LUMENS	INPUT	INCLUDED LED
HV3221T-BLK	3000K - 4000K - 5500K	90lm - 95lm - 100lm	12v DC	Tri-Colour Built-in 3w SMD LED
HV3222T-BLK	3000K - 4000K - 5500K	90lm - 95lm - 100lm	12v DC	Tri-Colour Built-in 3w SMD LED
HV3223T-BLK	3000K - 4000K - 5500K	90lm - 95lm - 100lm	12v DC	Tri-Colour Built-in 3w SMD LED

See pages 295-306 for compatible drivers. All low voltage products that specify an input of 12v or 24v DC must be used with a suitable LED driver.





HV3221T-WHT



HV3222T-WHT



HV3223T-WHT

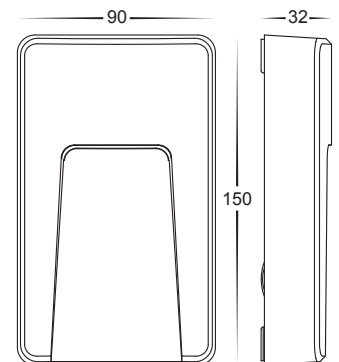
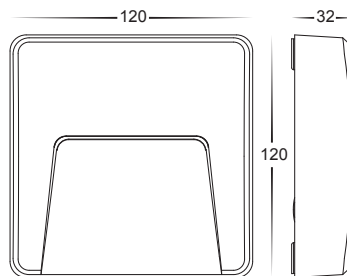
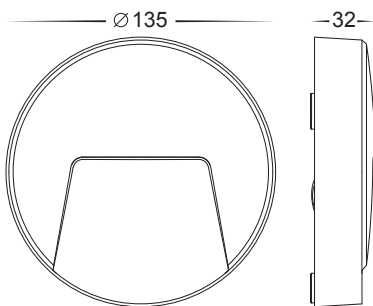
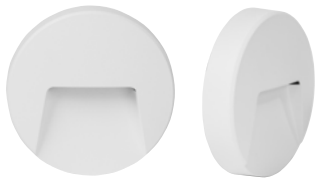

Seefore White

- Surface mounted step light
- Polycarbonate White
- IP Rating: IP65

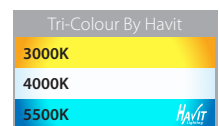

PART NUMBER	COLOUR TEMP	LUMENS	INPUT	INCLUDED LED
HV3221T-WHT	3000K - 4000K - 5500K	90lm - 95lm - 100lm	12v DC	Tri-Colour Built-in 3w SMD LED
HV3222T-WHT	3000K - 4000K - 5500K	90lm - 95lm - 100lm	12v DC	Tri-Colour Built-in 3w SMD LED
HV3223T-WHT	3000K - 4000K - 5500K	90lm - 95lm - 100lm	12v DC	Tri-Colour Built-in 3w SMD LED

See pages 295-306 for compatible drivers. All low voltage products that specify an input of 12v or 24v DC must be used with a suitable LED driver.



For detailed product specifications
visit www.Havit.com.au
or scan this QR code



HV3225T-BLK
Polycarbonate Black



HV3225T-WHT
Polycarbonate White

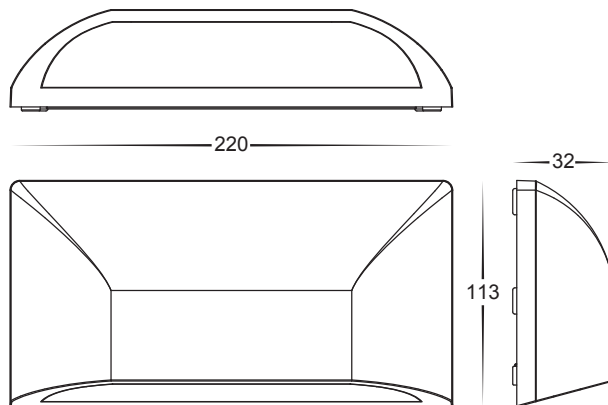

Seevive

- Rectangle surface mounted step light
- Polycarbonate Black or White with Opal diffuser
- IP Rating: IP65

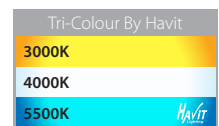

PART NUMBER	COLOUR TEMP	LUMENS	INPUT	INCLUDED LED
HV3225T-BLK	3000K - 4000K - 5500K	150lm - 155lm - 160lm	12v DC	Tri-Colour Built-in 5w SMD LED
HV3225T-WHT	3000K - 4000K - 5500K	150lm - 155lm - 160lm	12v DC	Tri-Colour Built-in 5w SMD LED

See pages 295-306 for compatible drivers. All low voltage products that specify an input of 12v or 24v DC must be used with a suitable LED driver.





HV3263W
316 Stainless Steel



Cutout
Ø30

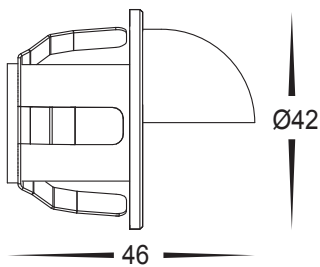

HV3264W
316 Stainless Steel



Cutout
Ø30

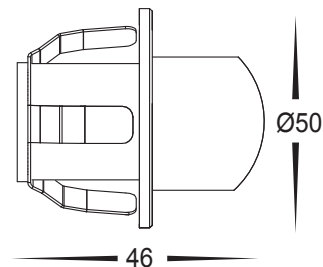

Sako 316 Stainless Steel

- Recessed mini step lights
- 316 Stainless Steel
- 30° beam angle
- Cut out: 30mm
- Installation depth: 40mm
- IP Rating: IP67

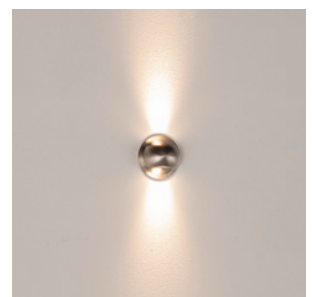

PART NUMBER	COLOUR TEMP	LUMENS	INPUT	INCLUDED LED
HV3263W	3000K	100lm	12v DC	Built-in 2w COB
HV3264W	3000K	2x 70lm	12v DC	Built-in 2w COB

See pages 295-306 for compatible drivers. All low voltage products that specify an input of 12v or 24v DC must be used with a suitable LED driver.



For detailed product specifications
visit www.Havit.com.au
or scan this QR code



HV3268T-BLK-12V-SQ

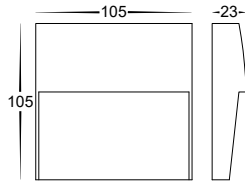

HV3268T-BLK-12V-RND

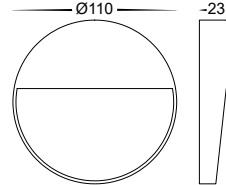

HV3269T-BLK-12V-SQ

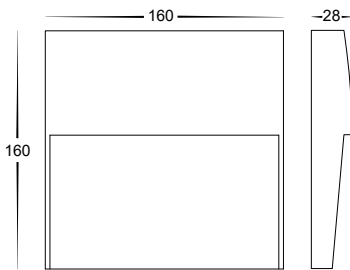

HV3269T-BLK-12V-RND

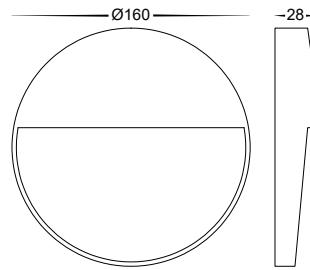

Fino Aluminium

- Outdoor Step Light
- Aluminium Poly Powder Coated Black
- Polycarbonate Diffuser
- IP Rating: IP54

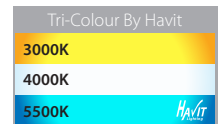

PART NUMBER	COLOUR TEMP	LUMENS	INPUT	INCLUDED LED
HV3268T-BLK-12V-RND	3000K - 4000K - 5500K	30lm - 33lm - 32lm	12v DC	Tri-Colour Built-in 3w SMD LED
HV3268T-BLK-12V-SQ	3000K - 4000K - 5500K	30lm - 33lm - 32lm	12v DC	Tri-Colour Built-in 3w SMD LED
HV3269T-BLK-12V-RND	3000K - 4000K - 5500K	195lm - 199lm - 198lm	12v DC	Tri-Colour Built-in 6w SMD LED
HV3269T-BLK-12V-SQ	3000K - 4000K - 5500K	195lm - 199lm - 198lm	12v DC	Tri-Colour Built-in 6w SMD LED

See pages 295-306 for compatible drivers. All low voltage products that specify an input of 12v or 24v DC must be used with a suitable LED driver.





HV3268T-WHT-12V-SQ

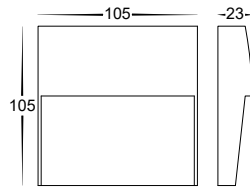

HV3268T-WHT-12V-RND

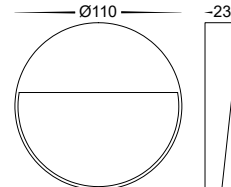

HV3269T-WHT-12V-SQ

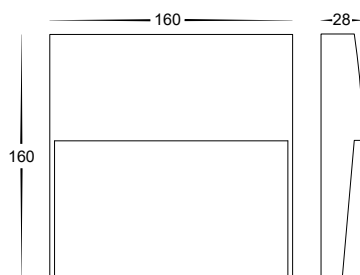

HV3269T-WHT-12V-RND

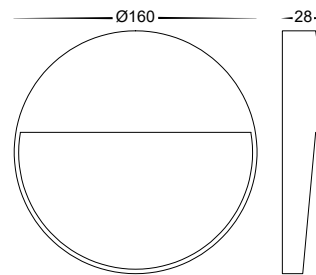

Fino Aluminium

- Outdoor Step Light
- Aluminium Poly Powder Coated White
- Polycarbonate Diffuser
- IP Rating: IP54

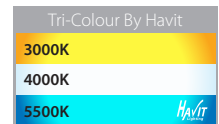

PART NUMBER	COLOUR TEMP	LUMENS	INPUT	INCLUDED LED
HV3268T-WHT-12V-RND	3000K - 4000K - 5500K	30lm - 33lm - 32lm	12v DC	Tri-Colour Built-in 3w SMD LED
HV3268T-WHT-12V-SQ	3000K - 4000K - 5500K	30lm - 33lm - 32lm	12v DC	Tri-Colour Built-in 3w SMD LED
HV3269T-WHT-12V-RND	3000K - 4000K - 5500K	195lm - 199lm - 198lm	12v DC	Tri-Colour Built-in 6w SMD LED
HV3269T-WHT-12V-SQ	3000K - 4000K - 5500K	195lm - 199lm - 198lm	12v DC	Tri-Colour Built-in 6w SMD LED

See pages 295-306 for compatible drivers. All low voltage products that specify an input of 12v or 24v DC must be used with a suitable LED driver.



For detailed product specifications
visit www.Havit.com.au
or scan this QR code



HV3270T-BLK-12V

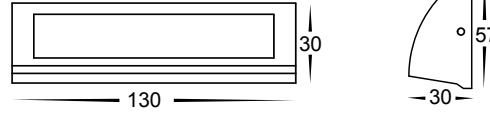

HV3271T-BLK-12V

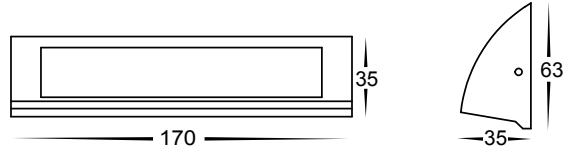

HV3272T-BLK-12V

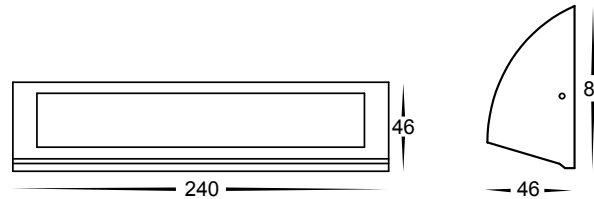

Taso Aluminium Black

- Surface mounted step light
- Aluminium Poly Powder Coated Black
- Polycarbonate Opal Diffuser
- IP Rating: IP54

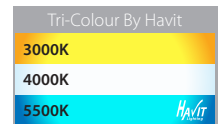

PART NUMBER	COLOUR TEMP	LUMENS	INPUT	INCLUDED LED
HV3270T-BLK-12V	3000K - 4000K - 5500K	180lm - 190lm - 200lm	12v DC	Tri-Colour Built-in 3.5w SMD LED
HV3271T-BLK-12V	3000K - 4000K - 5500K	350lm - 360lm - 370lm	12v DC	Tri-Colour Built-in 6w SMD LED
HV3272T-BLK-12V	3000K - 4000K - 5500K	600lm - 625lm - 650lm	12v DC	Tri-Colour Built-in 10w SMD LED

See pages 295-306 for compatible drivers. All low voltage products that specify an input of 12v or 24v DC must be used with a suitable LED driver.





HV3270T-WHT-12V

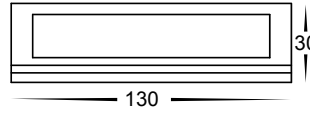

HV3271T-WHT-12V

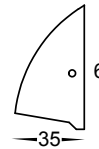

HV3272T-WHT-12V

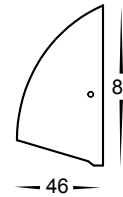
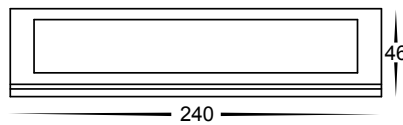

Taso Aluminium White

- Surface mounted step light
- Aluminium Poly Powder Coated White
- Polycarbonate Opal Diffuser
- IP Rating: IP54

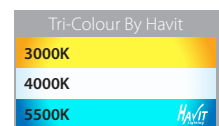

PART NUMBER	COLOUR TEMP	LUMENS	INPUT	INCLUDED LED
HV3270T-WHT-12V	3000K - 4000K - 5500K	180lm - 190lm - 200lm	12v DC	Tri-Colour Built-in 3.5w SMD LED
HV3271T-WHT-12V	3000K - 4000K - 5500K	350lm - 360lm - 370lm	12v DC	Tri-Colour Built-in 6w SMD LED
HV3272T-WHT-12V	3000K - 4000K - 5500K	600lm - 625lm - 650lm	12v DC	Tri-Colour Built-in 10w SMD LED

See pages 295-306 for compatible drivers. All low voltage products that specify an input of 12v or 24v DC must be used with a suitable LED driver.



For detailed product specifications
visit www.Havit.com.au
or scan this QR code





HV3270T-SLV-12V

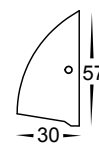
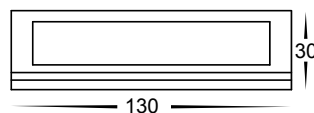

HV3271T-SLV-12V

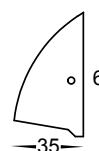
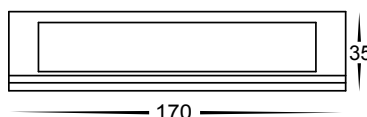

HV3272T-SLV-12V

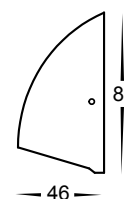
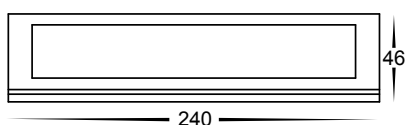

Taso Aluminium Silver

- Surface mounted step light
- Aluminium Poly Powder Coated Silver
- Polycarbonate Opal Diffuser
- IP Rating: IP54

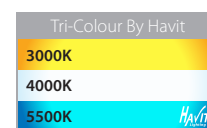

PART NUMBER	COLOUR TEMP	LUMENS	INPUT	INCLUDED LED
HV3270T-SLV-12V	3000K - 4000K - 5500K	180lm - 190lm - 200lm	12v DC	Tri-Colour Built-in 3.5w SMD LED
HV3271T-SLV-12V	3000K - 4000K - 5500K	350lm - 360lm - 370lm	12v DC	Tri-Colour Built-in 6w SMD LED
HV3272T-SLV-12V	3000K - 4000K - 5500K	600lm - 625lm - 650lm	12v DC	Tri-Colour Built-in 10w SMD LED

See pages 295-306 for compatible drivers. All low voltage products that specify an input of 12v or 24v DC must be used with a suitable LED driver.



For detailed product specifications
visit www.Havit.com.au
or scan this QR code

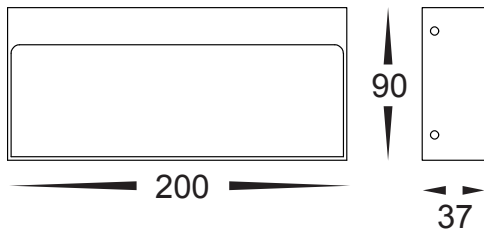

HV3275T-BLK-240V
HV3275T-BLK-12V

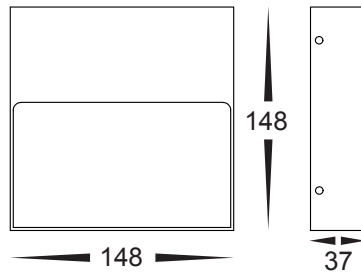

HV3276T-BLK-240V
HV3276T-BLK-12V

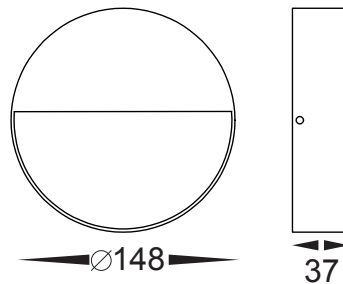

HV3277T-BLK-240V
HV3277T-BLK-12V

Virisma Aluminium Black

- Surface mounted step light
- Aluminium Poly Powder Coated Black
- Polycarbonate Opal Diffuser
- IP Rating: IP54

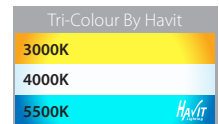

PART NUMBER	COLOUR TEMP	LUMENS	INPUT	INCLUDED LED
HV3275T-BLK-240V	3000K - 4000K - 5500K	200lm - 210lm - 220lm	240v	Tri-Colour Built-in 6w SMD LED
HV3275T-BLK-12V	3000K - 4000K - 5500K	200lm - 210lm - 220lm	12v DC	Tri-Colour Built-in 6w SMD LED
HV3276T-BLK-240V	3000K - 4000K - 5500K	110lm - 115lm - 120lm	240v	Tri-Colour Built-in 4w SMD LED
HV3276T-BLK-12V	3000K - 4000K - 5500K	110lm - 115lm - 120lm	12v DC	Tri-Colour Built-in 4w SMD LED
HV3277T-BLK-240V	3000K - 4000K - 5500K	110lm - 115lm - 120lm	240v	Tri-Colour Built-in 4w SMD LED
HV3277T-BLK-12V	3000K - 4000K - 5500K	110lm - 115lm - 120lm	12v DC	Tri-Colour Built-in 4w SMD LED

See pages 295-306 for compatible drivers. All low voltage products that specify an input of 12v or 24v DC must be used with a suitable LED driver.



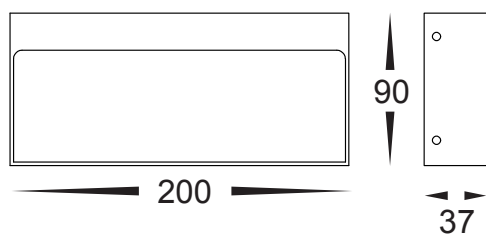

HV3275T- WHT-240V
HV3275T- WHT-12V

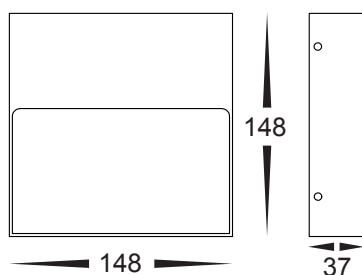

HV3276T- WHT-240V
HV3276T- WHT-12V

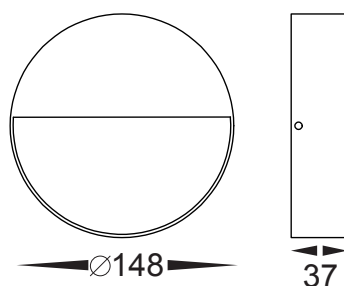

HV3277T- WHT-240V
HV3277T- WHT-12V

Virisma Aluminium White

- Surface mounted step light
- Aluminium Poly Powder Coated White
- Polycarbonate Opal Diffuser
- IP Rating: IP54

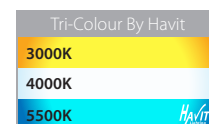

PART NUMBER	COLOUR TEMP	LUMENS	INPUT	INCLUDED LED
HV3275T-WHT-240V	3000K - 4000K - 5500K	200lm - 210lm - 220lm	240v	Tri-Colour Built-in 6w SMD LED
HV3275T-WHT-12V	3000K - 4000K - 5500K	200lm - 210lm - 220lm	12v DC	Tri-Colour Built-in 6w SMD LED
HV3276T-WHT-240V	3000K - 4000K - 5500K	110lm - 115lm - 120lm	240v	Tri-Colour Built-in 4w SMD LED
HV3276T-WHT-12V	3000K - 4000K - 5500K	110lm - 115lm - 120lm	12v DC	Tri-Colour Built-in 4w SMD LED
HV3277T-WHT-240V	3000K - 4000K - 5500K	110lm - 115lm - 120lm	240v	Tri-Colour Built-in 4w SMD LED
HV3277T-WHT-12V	3000K - 4000K - 5500K	110lm - 115lm - 120lm	12v DC	Tri-Colour Built-in 4w SMD LED

See pages 295-306 for compatible drivers. All low voltage products that specify an input of 12v or 24v DC must be used with a suitable LED driver.



For detailed product specifications
visit www.Havit.com.au
or scan this QR code



HV3278T-BLK-240V
HV3278T-BLK-12V

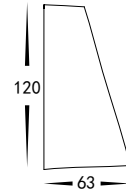
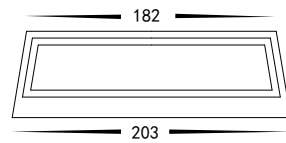

HV3279T-BLK-240V
HV3279T-BLK-12V

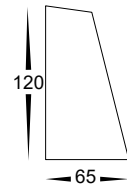

Shim Aluminium Black

- Surface mounted LED step light
- Aluminium Poly Powder Coated Black
- Polycarbonate Opal Diffuser
- IP Rating: IP54

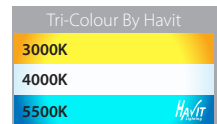

PART NUMBER	COLOUR TEMP	LUMENS	INPUT	INCLUDED LED
HV3278T-BLK-240V	3000K - 4000K - 5500K	960lm - 1020lm - 1080lm	240V	Tri-Colour Built-in 12w SMD LED
HV3278T-BLK-12V	3000K - 4000K - 5500K	960lm - 1020lm - 1080lm	12v DC	Tri-Colour Built-in 12w SMD LED
HV3279T-BLK-240V	3000K - 4000K - 5500K	1120lm - 1150lm - 1190lm	240V	Tri-Colour Built-in 14w SMD LED
HV3279T-BLK-12V	3000K - 4000K - 5500K	1120lm - 1150lm - 1190lm	12v DC	Tri-Colour Built-in 14w SMD LED

See pages 295-306 for compatible drivers. All low voltage products that specify an input of 12v or 24v DC must be used with a suitable LED driver.





HV3278T- WHT-240V
HV3278T- WHT-12V

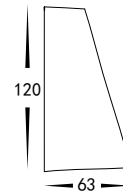
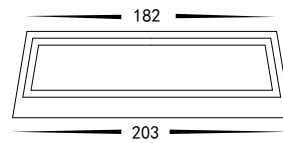

HV3279T- WHT-240V
HV3279T- WHT-12V

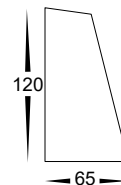

Shim Aluminium White

- Surface mounted LED step light
- Aluminium Poly Powder Coated White
- Polycarbonate Opal Diffuser
- IP Rating: IP54

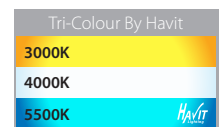

PART NUMBER	COLOUR TEMP	LUMENS	INPUT	INCLUDED LED
HV3278T-WHT-240V	3000K - 4000K - 5500K	960lm - 1020lm - 1080lm	240V	Tri-Colour Built-in 12w SMD LED
HV3278T-WHT-12V	3000K - 4000K - 5500K	960lm - 1020lm - 1080lm	12v DC	Tri-Colour Built-in 12w SMD LED
HV3279T-WHT-240V	3000K - 4000K - 5500K	1120lm - 1150lm - 1190lm	240V	Tri-Colour Built-in 14w SMD LED
HV3279T-WHT-12V	3000K - 4000K - 5500K	1120lm - 1150lm - 1190lm	12v DC	Tri-Colour Built-in 14w SMD LED

See pages 295-306 for compatible drivers. All low voltage products that specify an input of 12v or 24v DC must be used with a suitable LED driver.



For detailed product specifications
visit www.Havit.com.au
or scan this QR code





HV3281T-SS316-12V
316 Stainless Steel



HV3281T-AB-12V
Antique Brass



HV3281T-PSS316-12V
Polished Stainless Steel



HV3281T-BLK-12V
Stainless Steel Black



HV3281T-BR-12V
Solid Brass



HV3281T-WHT-12V
Stainless Steel White

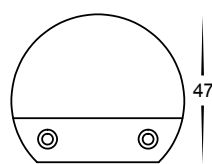
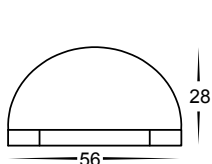

Occhio

- Surface mounted LED eyelid step light
- 316 Stainless Steel, Polished Stainless Steel, Solid Brass, Antique Brass, Black and White
- Dimmable
- IP Rating: IP65

i Solid Brass and Solid Copper fittings will naturally tarnish. Solid Brass fittings with additional coloured coatings (Antique Brass & Graphite) may tarnish through the coating when installed in outdoor environments.

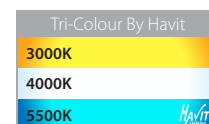

PART NUMBER	COLOUR TEMP	LUMENS	INPUT	INCLUDED LED
HV3281T-SS316-12V	3000K - 4000K - 5500K	240lm - 250lm - 260lm	12v DC	Tri-Colour Built-in 3w COB LED
HV3281T-PSS316-12V	3000K - 4000K - 5500K	240lm - 250lm - 260lm	12v DC	Tri-Colour Built-in 3w COB LED
HV3281T-BR-12V	3000K - 4000K - 5500K	240lm - 250lm - 260lm	12v DC	Tri-Colour Built-in 3w COB LED
HV3281T-AB-12V	3000K - 4000K - 5500K	240lm - 250lm - 260lm	12v DC	Tri-Colour Built-in 3w COB LED
HV3281T-BLK-12V	3000K - 4000K - 5500K	240lm - 250lm - 260lm	12v DC	Tri-Colour Built-in 3w COB LED
HV3281T-WHT-12V	3000K - 4000K - 5500K	240lm - 250lm - 260lm	12v DC	Tri-Colour Built-in 3w COB LED

See pages 295-306 for compatible drivers. All low voltage products that specify an input of 12v or 24v DC must be used with a suitable LED driver.



For detailed product specifications visit www.Havit.com.au or scan this QR code



HV3282T-SS316
Stainless Steel

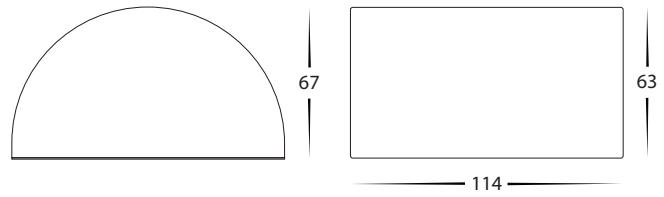

HV3282T-BLK
Stainless Steel Black



HV3282T-WHT
Stainless Steel White



HV3282T-GPH
Solid Brass Graphite



HV3282T-BRZ
Solid Bronze



Mood

- Surface mounted LED step light
- 316 Stainless Steel, Stainless Steel Black, Stainless Steel White, Solid Brass Graphite, Solid Bronze
- IP Rating: IP54

i Solid Brass and Solid Copper fittings will naturally tarnish. Solid Brass fittings with additional coloured coatings (Antique Brass & Graphite) may tarnish through the coating when installed in outdoor environments.

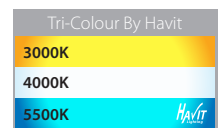

PART NUMBER	COLOUR TEMP	LUMENS	INPUT	INCLUDED LED
HV3282T-SS316	3000K - 4000K - 5500K	460lm - 490lm - 520lm	12v DC	Tri-Colour Built-in 6w LED
HV3282T-BLK	3000K - 4000K - 5500K	460lm - 490lm - 520lm	12v DC	Tri-Colour Built-in 6w LED
HV3282T-WHT	3000K - 4000K - 5500K	460lm - 490lm - 520lm	12v DC	Tri-Colour Built-in 6w LED
HV3282T-GPH	3000K - 4000K - 5500K	460lm - 490lm - 520lm	12v DC	Tri-Colour Built-in 6w LED
HV3282T-BRZ	3000K - 4000K - 5500K	460lm - 490lm - 520lm	12v DC	Tri-Colour Built-in 6w LED

See pages 295-306 for compatible drivers. All low voltage products that specify an input of 12v or 24v DC must be used with a suitable LED driver.





HV3283T-SS316
Stainless Steel

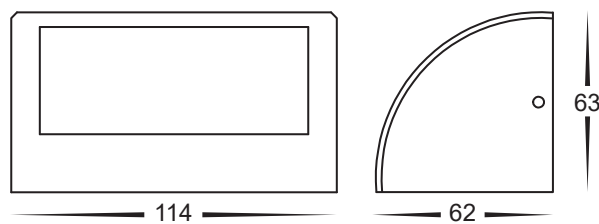

HV3283T-BLK
Stainless Steel Black



HV3283T-WHT
Stainless Steel White



HV3283T-GPH
Solid Brass Graphite



HV3283T-BRZ
Solid Bronze



Ridge

- Surface mounted LED step light
- 316 Stainless Steel, Stainless Steel Black, Stainless Steel White, Solid Brass Graphite, Solid Bronze
- IP Rating: IP54

i Solid Brass and Solid Copper fittings will naturally tarnish. Solid Brass fittings with additional coloured coatings (Antique Brass & Graphite) may tarnish through the coating when installed in outdoor environments.

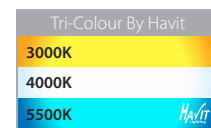

PART NUMBER	COLOUR TEMP	LUMENS	INPUT	INCLUDED LED
HV3283T-SS316	3000K - 4000K - 5500K	460lm - 490lm - 520lm	12v DC	Tri-Colour Built-in 6w LED
HV3283T-BLK	3000K - 4000K - 5500K	460lm - 490lm - 520lm	12v DC	Tri-Colour Built-in 6w LED
HV3283T-WHT	3000K - 4000K - 5500K	460lm - 490lm - 520lm	12v DC	Tri-Colour Built-in 6w LED
HV3283T-GPH	3000K - 4000K - 5500K	460lm - 490lm - 520lm	12v DC	Tri-Colour Built-in 6w LED
HV3283T-BRZ	3000K - 4000K - 5500K	460lm - 490lm - 520lm	12v DC	Tri-Colour Built-in 6w LED

See pages 295-306 for compatible drivers. All low voltage products that specify an input of 12v or 24v DC must be used with a suitable LED driver.



For detailed product specifications visit www.Havit.com.au or scan this QR code



HV3288T-SS316-12V
316 Stainless Steel



HV3288T-GPH-12V
Graphite Coloured Brass



HV3288T-BR-12V
Solid Brass



HV3288T-AB-12V
Antique Brass



HV3288T-BLK-12V
Solid Brass Black

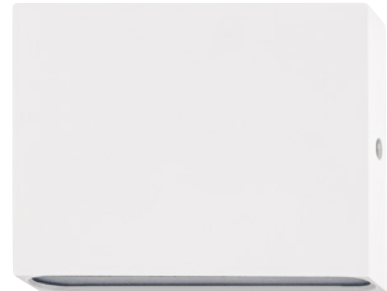

HV3288T-WHT-12V
Solid Brass White

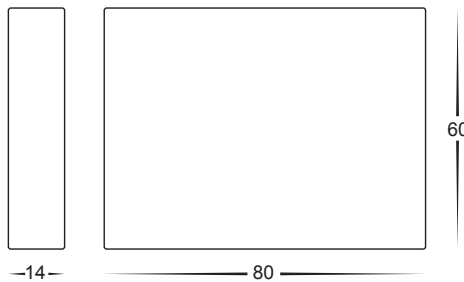

Stylez

- Rectangular LED step light
- 316 Stainless Steel, Graphite, Solid Brass, Antique Brass, Black and White
- IP Rating: IP65
- Dimmable

i Solid Brass and Solid Copper fittings will naturally tarnish. Solid Brass fittings with additional coloured coatings (Antique Brass & Graphite) may tarnish through the coating when installed in outdoor environments.

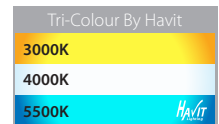

PART NUMBER	COLOUR TEMP	LUMENS	INPUT	INCLUDED LED
HV3288T-AB-12V	3000K - 4000K - 5500K	240lm - 245lm - 250lm	12v DC	Tri-Colour Built in 3w LED
HV3288T-BLK-12V	3000K - 4000K - 5500K	240lm - 245lm - 250lm	12v DC	Tri-Colour Built in 3w LED
HV3288T-BR-12V	3000K - 4000K - 5500K	240lm - 245lm - 250lm	12v DC	Tri-Colour Built in 3w LED
HV3288T-GPH-12V	3000K - 4000K - 5500K	240lm - 245lm - 250lm	12v DC	Tri-Colour Built in 3w LED
HV3288T-SS316-12V	3000K - 4000K - 5500K	240lm - 245lm - 250lm	12v DC	Tri-Colour Built in 3w LED
HV3288T-WHT-12V	3000K - 4000K - 5500K	240lm - 245lm - 250lm	12v DC	Tri-Colour Built in 3w LED

See pages 295-306 for compatible drivers. All low voltage products that specify an input of 12v or 24v DC must be used with a suitable LED driver.





HV3289T-SS316-12V
316 Stainless Steel



HV3289T-GPH-12V
Graphite Coloured Brass



HV3289T-BR-12V
Solid Brass



HV3289T-BLK-12V
Solid Brass Black

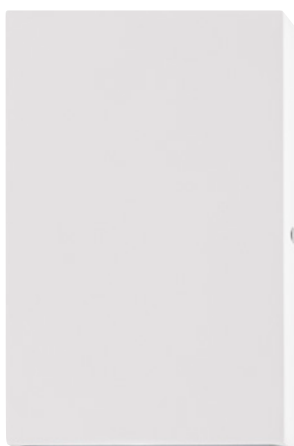

HV3289T-WHT-12V
Solid Brass White



HV3289T-AB-12V
Antique Brass

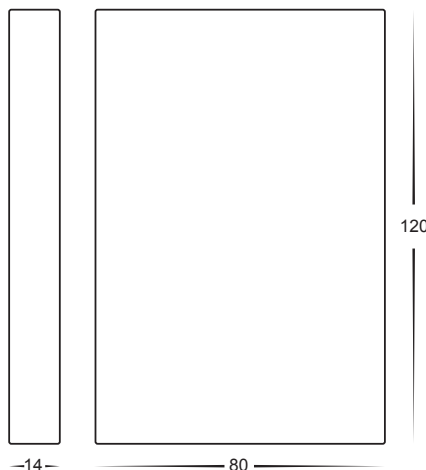

Stylez

- Rectangular up & down LED steplight
- 316 Stainless Steel, Graphite, Solid Brass, Antique Brass, Black and White
- IP Rating: IP65
- Dimmable

i Solid Brass and Solid Copper fittings will naturally tarnish. Solid Brass fittings with additional coloured coatings (Antique Brass & Graphite) may tarnish through the coating when installed in outdoor environments.

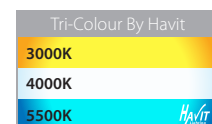

PART NUMBER	COLOUR TEMP	LUMENS	INPUT	INCLUDED LED
HV3289T-AB-12V	3000K - 4000K - 5500K	2x 240lm -2x 245lm - 2x 250lm	12v DC	Tri-Colour Built in 2x 3w LED
HV3289T-BLK-12V	3000K - 4000K - 5500K	2x 240lm -2x 245lm - 2x 250lm	12v DC	Tri-Colour Built in 2x 3w LED
HV3289T-BR-12V	3000K - 4000K - 5500K	2x 240lm -2x 245lm - 2x 250lm	12v DC	Tri-Colour Built in 2x 3w LED
HV3289T-GPH-12V	3000K - 4000K - 5500K	2x 240lm -2x 245lm - 2x 250lm	12v DC	Tri-Colour Built in 2x 3w LED
HV3289T-SS316-12V	3000K - 4000K - 5500K	2x 240lm -2x 245lm - 2x 250lm	12v DC	Tri-Colour Built in 2x 3w LED
HV3289T-WHT-12V	3000K - 4000K - 5500K	2x 240lm -2x 245lm - 2x 250lm	12v DC	Tri-Colour Built in 2x 3w LED

See pages 295-306 for compatible drivers. All low voltage products that specify an input of 12v or 24v DC must be used with a suitable LED driver.



For detailed product specifications visit www.Havit.com.au or scan this QR code



HV3291T-AB-12V
Antique Brass



HV3291T-BR-12V
Solid Brass



HV3291T-BLK-12V
Solid Brass Black



HV3291T-WHT-12V
Solid Brass White

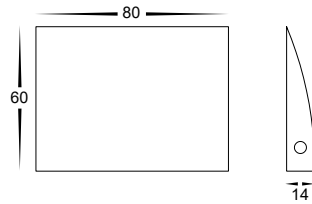

i Solid Brass and Solid Copper fittings will naturally tarnish. Solid Brass fittings with additional coloured coatings (Antique Brass & Graphite) may tarnish through the coating when installed in outdoor environments.

Pelase Solid Brass

- Surface Mounted Step or Wall Light
- Solid Brass with Antique Brass Finish, Solid Brass, Powder Coated Black or White
- IP Rating: IP65
- IK Rating: IK08

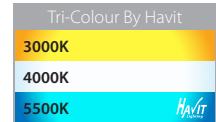

PART NUMBER	COLOUR TEMP	LUMENS	INPUT	INCLUDED LED
HV3291T-AB-12V	3000K - 4000K - 5500K	240lm - 245lm - 250lm	12v DC	Tri Colour 3w Built in LED
HV3291T-BLK-12V	3000K - 4000K - 5500K	240lm - 245lm - 250lm	12v DC	Tri Colour 3w Built in LED
HV3291T-BR-12V	3000K - 4000K - 5500K	240lm - 245lm - 250lm	12v DC	Tri Colour 3w Built in LED
HV3291T-WHT-12V	3000K - 4000K - 5500K	240lm - 245lm - 250lm	12v DC	Tri Colour 3w Built in LED

See pages 295-306 for compatible drivers. All low voltage products that specify an input of 12v or 24v DC must be used with a suitable LED driver.





HV3292T-AB-12V
Antique Brass



HV3292T-BR-12V
Solid Brass



HV3292T-BLK-12V
Solid Brass Black



HV3292T-WHT-12V
Solid Brass White

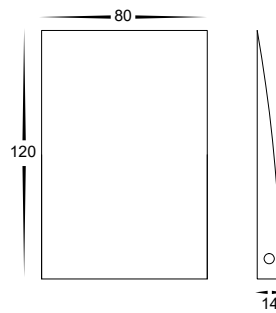

i Solid Brass and Solid Copper fittings will naturally tarnish. Solid Brass fittings with additional coloured coatings (Antique Brass & Graphite) may tarnish through the coating when installed in outdoor environments.

Pelase Solid Brass

- Surface Mounted Step or Wall Light
- Solid Brass with Antique Brass Finish, Solid Brass, Powder Coated Black or White
- IP Rating: IP65
- IK Rating: IK08

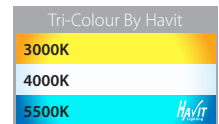

PART NUMBER	COLOUR TEMP	LUMENS	INPUT	INCLUDED LED
HV3292T-AB-12V	3000K - 4000K - 5500K	240lm - 245lm - 250lm	12v DC	Tri Colour 3w Built in LED
HV3292T-BLK-12V	3000K - 4000K - 5500K	240lm - 245lm - 250lm	12v DC	Tri Colour 3w Built in LED
HV3292T-BR-12V	3000K - 4000K - 5500K	240lm - 245lm - 250lm	12v DC	Tri Colour 3w Built in LED
HV3292T-WHT-12V	3000K - 4000K - 5500K	240lm - 245lm - 250lm	12v DC	Tri Colour 3w Built in LED

See pages 295-306 for compatible drivers. All low voltage products that specify an input of 12v or 24v DC must be used with a suitable LED driver.



For detailed product specifications visit www.Havit.com.au or scan this QR code

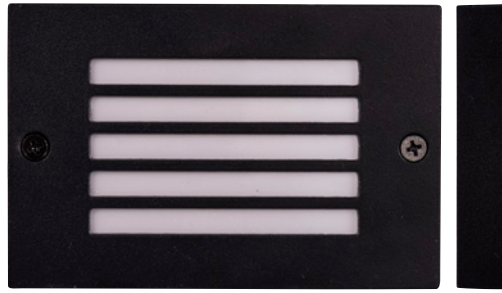

HV3295T-BLK-12V
Aluminium Black

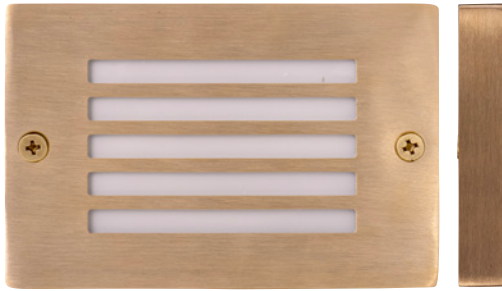

HV3295T-BR-12V
Solid Brass



HV3295T-AB-12V
Antique Brass

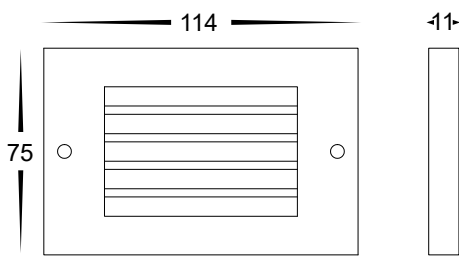

i Solid Brass and Solid Copper fittings will naturally tarnish. Solid Brass fittings with additional coloured coatings (Antique Brass & Graphite) may tarnish through the coating when installed in outdoor environments.

Ardam

- Surface Mounted Step or Wall Light
- Solid Brass with Antique Brass Finish, Brass, Aluminium Powder Coated Black
- IP Rating: IP65
- IK Rating: IK08

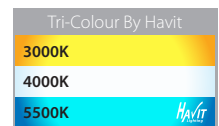

PART NUMBER	COLOUR TEMP	LUMENS	INPUT	INCLUDED LED
HV3295T-AB-12V	3000K - 4000K - 5500K	180lm - 190lm - 185lm	12v DC	Tri Colour 3w Built in LED
HV3295T-BLK-12V	3000K - 4000K - 5500K	180lm - 190lm - 185lm	12v DC	Tri Colour 3w Built in LED
HV3295T-BR-12V	3000K - 4000K - 5500K	180lm - 190lm - 185lm	12v DC	Tri Colour 3w Built in LED

See pages 295-306 for compatible drivers. All low voltage products that specify an input of 12v or 24v DC must be used with a suitable LED driver.



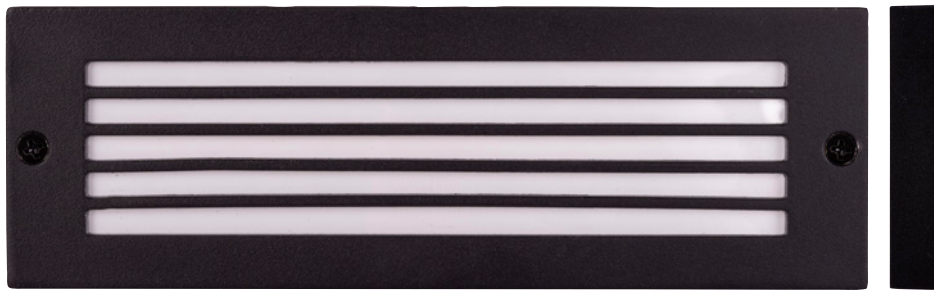

HV3296T-BLK-12V
Aluminium Black

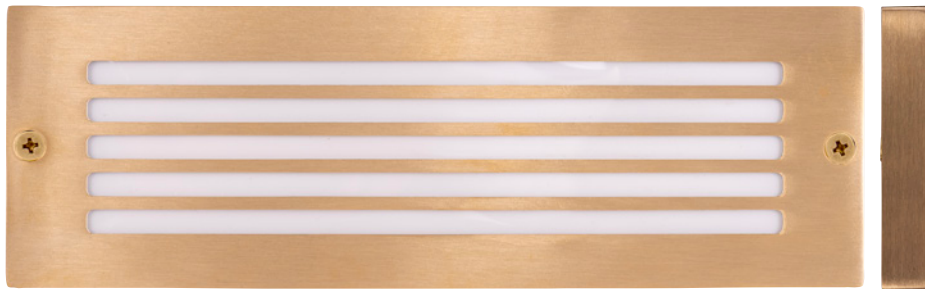

HV3296T-BR-12V
Solid Brass



HV3296T-AB-12V
Antique Brass

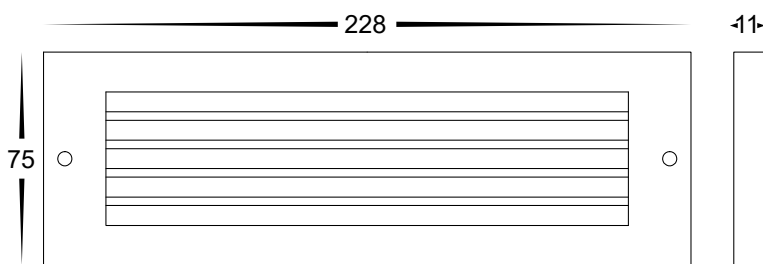

i Solid Brass and Solid Copper fittings will naturally tarnish. Solid Brass fittings with additional coloured coatings (Antique Brass & Graphite) may tarnish through the coating when installed in outdoor environments.

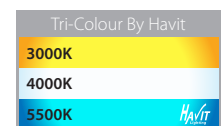

Ardam

- Surface Mounted Step or Wall Light
- Solid Brass with Antique Brass Finish, Brass, Aluminium Powder Coated Black
- IP Rating: IP65
- IK Rating: IK08

PART NUMBER	COLOUR TEMP	LUMENS	INPUT	INCLUDED LED
HV3296T-AB-12V	3000K - 4000K - 5500K	360lm - 380lm - 370lm	12v DC	Tri Colour 6w Built in LED
HV3296T-BLK-12V	3000K - 4000K - 5500K	360lm - 380lm - 370lm	12v DC	Tri Colour 6w Built in LED
HV3296T-BR-12V	3000K - 4000K - 5500K	360lm - 380lm - 370lm	12v DC	Tri Colour 6w Built in LED

See pages 295-306 for compatible drivers. All low voltage products that specify an input of 12v or 24v DC must be used with a suitable LED driver.



For detailed product specifications
visit www.Havit.com.au
or scan this QR code





HV3297T-BLK-12V
Aluminium Black



HV3297T-BR-12V
Solid Brass



HV3297T-AB-12V
Antique Brass

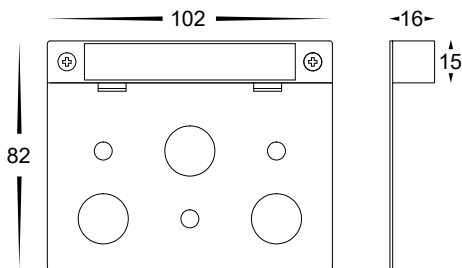
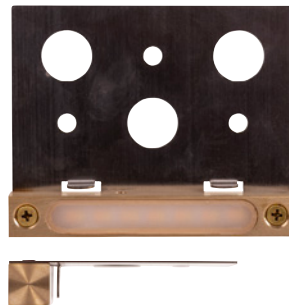
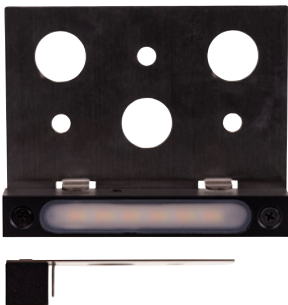

i Solid Brass and Solid Copper fittings will naturally tarnish. Solid Brass fittings with additional coloured coatings (Antique Brass & Graphite) may tarnish through the coating when installed in outdoor environments.

Preston

- Coping Light
- Solid Brass with Antique Brass Finish, Brass, Aluminium Powder Coated Black
- IP Rating: IP65
- IK Rating: IK08

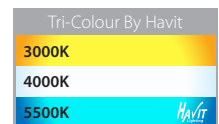

PART NUMBER	COLOUR TEMP	LUMENS	INPUT	INCLUDED LED
HV3297T-AB-12V	3000K - 4000K - 5500K	140lm - 150lm - 145lm	12v DC	Tri Colour 2.5w Built in LED
HV3297T-BLK-12V	3000K - 4000K - 5500K	140lm - 150lm - 145lm	12v DC	Tri Colour 2.5w Built in LED
HV3297T-BR-12V	3000K - 4000K - 5500K	140lm - 150lm - 145lm	12v DC	Tri Colour 2.5w Built in LED

See pages 295-306 for compatible drivers. All low voltage products that specify an input of 12v or 24v DC must be used with a suitable LED driver.



For detailed product specifications visit www.Havit.com.au or scan this QR code

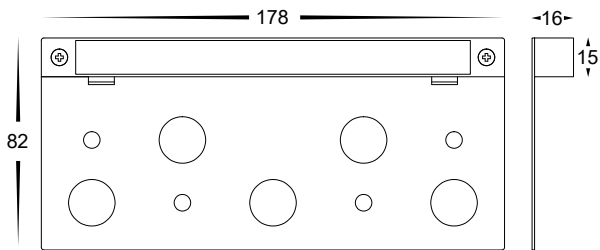
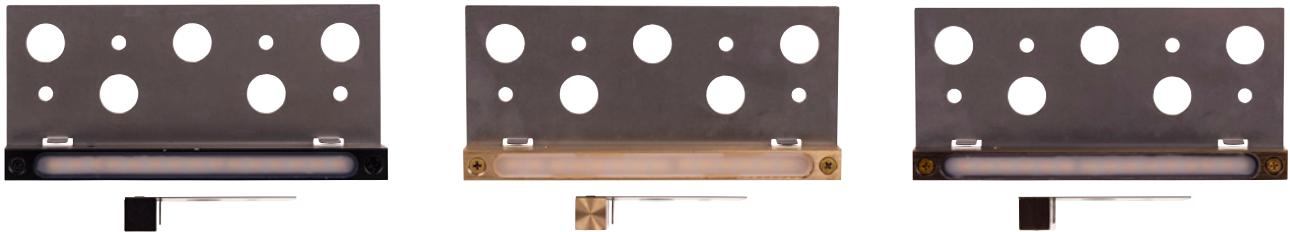
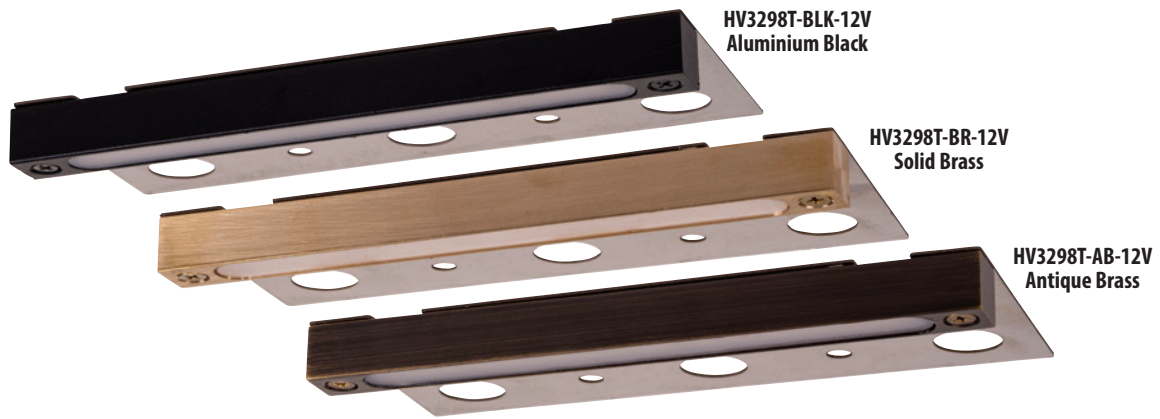

i Solid Brass and Solid Copper fittings will naturally tarnish. Solid Brass fittings with additional coloured coatings (Antique Brass & Graphite) may tarnish through the coating when installed in outdoor environments.

Preston

- Coping Light
- Solid Brass with Antique Brass Finish, Brass, Aluminium Powder Coated Black
- IP Rating: IP65
- IK Rating: IK08

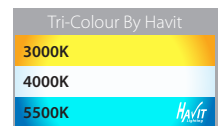

PART NUMBER	COLOUR TEMP	LUMENS	INPUT	INCLUDED LED
HV3298T-AB-12V	3000K - 4000K - 5500K	280lm - 300lm - 290lm	12v DC	Tri Colour 5w Built in LED
HV3298T-BLK-12V	3000K - 4000K - 5500K	280lm - 300lm - 290lm	12v DC	Tri Colour 5w Built in LED
HV3298T-BR-12V	3000K - 4000K - 5500K	280lm - 300lm - 290lm	12v DC	Tri Colour 5w Built in LED

See pages 295-306 for compatible drivers. All low voltage products that specify an input of 12v or 24v DC must be used with a suitable LED driver.





HV3299T-BLK-12V
Aluminium Black

HV3299T-BR-12V
Solid Brass

HV3299T-AB-12V
Antique Brass

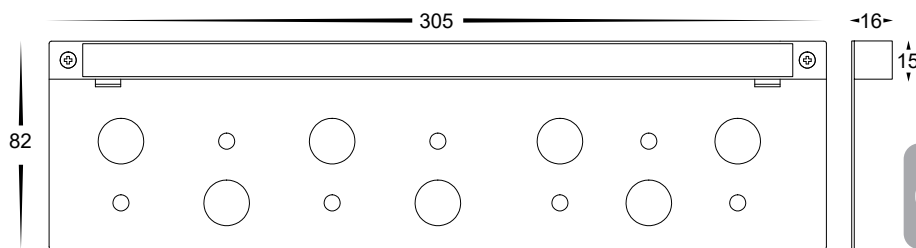
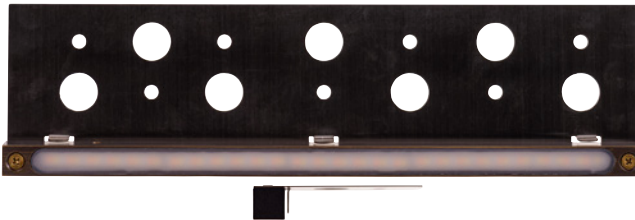
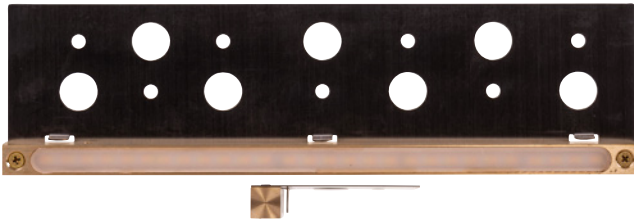

i Solid Brass and Solid Copper fittings will naturally tarnish. Solid Brass fittings with additional coloured coatings (Antique Brass & Graphite) may tarnish through the coating when installed in outdoor environments.

Preston

- Coping Light
- Solid Brass with Antique Brass Finish, Brass, Aluminium Powder Coated Black
- IP Rating: IP65
- IK Rating: IK08

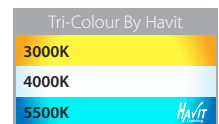

PART NUMBER	COLOUR TEMP	LUMENS	INPUT	INCLUDED LED
HV3299T-AB-12V	3000K - 4000K - 5500K	420lm - 440lm - 430lm	12v DC	Tri Colour 7.5w Built in LED
HV3299T-BLK-12V	3000K - 4000K - 5500K	420lm - 440lm - 430lm	12v DC	Tri Colour 7.5w Built in LED
HV3299T-BR-12V	3000K - 4000K - 5500K	420lm - 440lm - 430lm	12v DC	Tri Colour 7.5w Built in LED

See pages 295-306 for compatible drivers. All low voltage products that specify an input of 12v or 24v DC must be used with a suitable LED driver.



For detailed product specifications visit www.Havit.com.au or scan this QR code



HV36042T
316 Stainless Steel

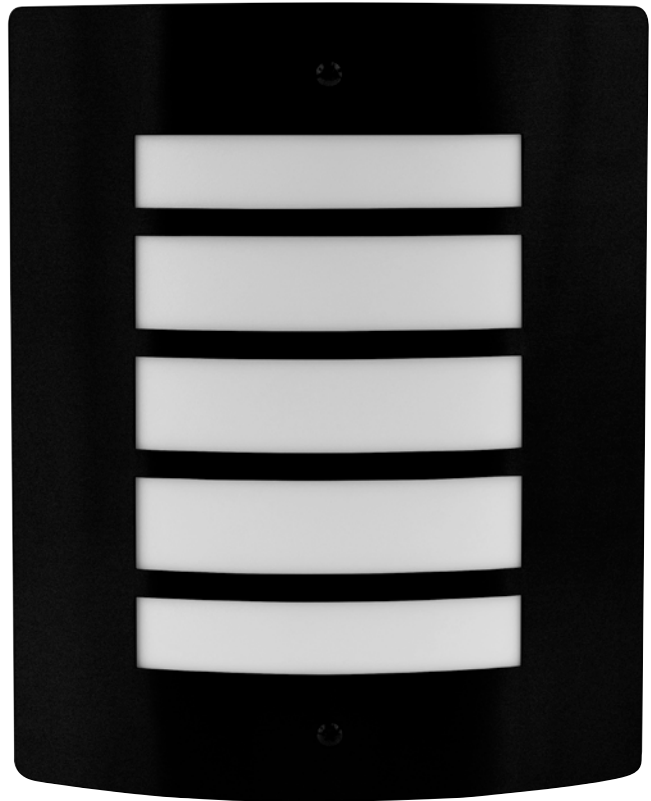

HV36042T-BLK
Stainless Steel Black

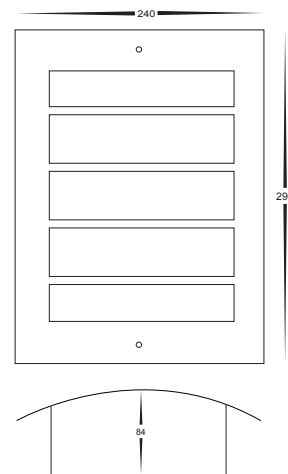

Mask 316 Stainless Steel

- Wall mask
- 316 Stainless Steel Marine Grade or Stainless Steel Black
- Five slot with opal diffuser
- IP Rating: IP54

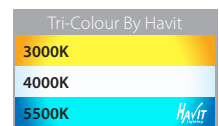

PART NUMBER	COLOUR TEMP	LUMENS	INPUT	INCLUDED LED
HV36042T	3000K - 4000K - 5500K	520lm - 550lm - 580lm	240v	Tri-Colour Built-in 10w SMD LED
HV36042T-BLK	3000K - 4000K - 5500K	520lm - 550lm - 580lm	240v	Tri-Colour Built-in 10w SMD LED





HV35021T-BLK
Aluminium Black



HV35021T-WHT
Aluminium White

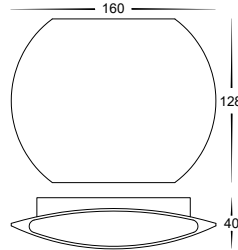

HV35022T-BLK
Aluminium Black



HV35022T-WHT
Aluminium White

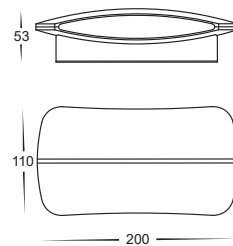

Cara Aluminium

- Exterior Up and Down Wall Light
- Aluminum Poly Powder Coated Black and White
- Polycarbonate Opal Diffuser
- IP Rating: IP54

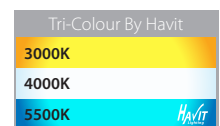

PART NUMBER	COLOUR TEMP	LUMENS	INPUT	INCLUDED LED
HV35021T-BLK	3000K - 4000K - 5500K	2x 230lm - 2x 245lm - 2x 235lm	240v	Tri-Colour Built in 2x 3w LED
HV35021T-WHT	3000K - 4000K - 5500K	2x 230lm - 2x 245lm - 2x 235lm	240v	Tri-Colour Built in 2x 3w LED
HV35022T-BLK	3000K - 4000K - 5500K	2x 250lm - 2x 300lm - 2x 280lm	240v	Tri-Colour Built in 2x 4.5w LED
HV35022T-WHT	3000K - 4000K - 5500K	2x 250lm - 2x 300lm - 2x 280lm	240v	Tri-Colour Built in 2x 4.5w LED



For detailed product specifications
visit www.Havit.com.au
or scan this QR code

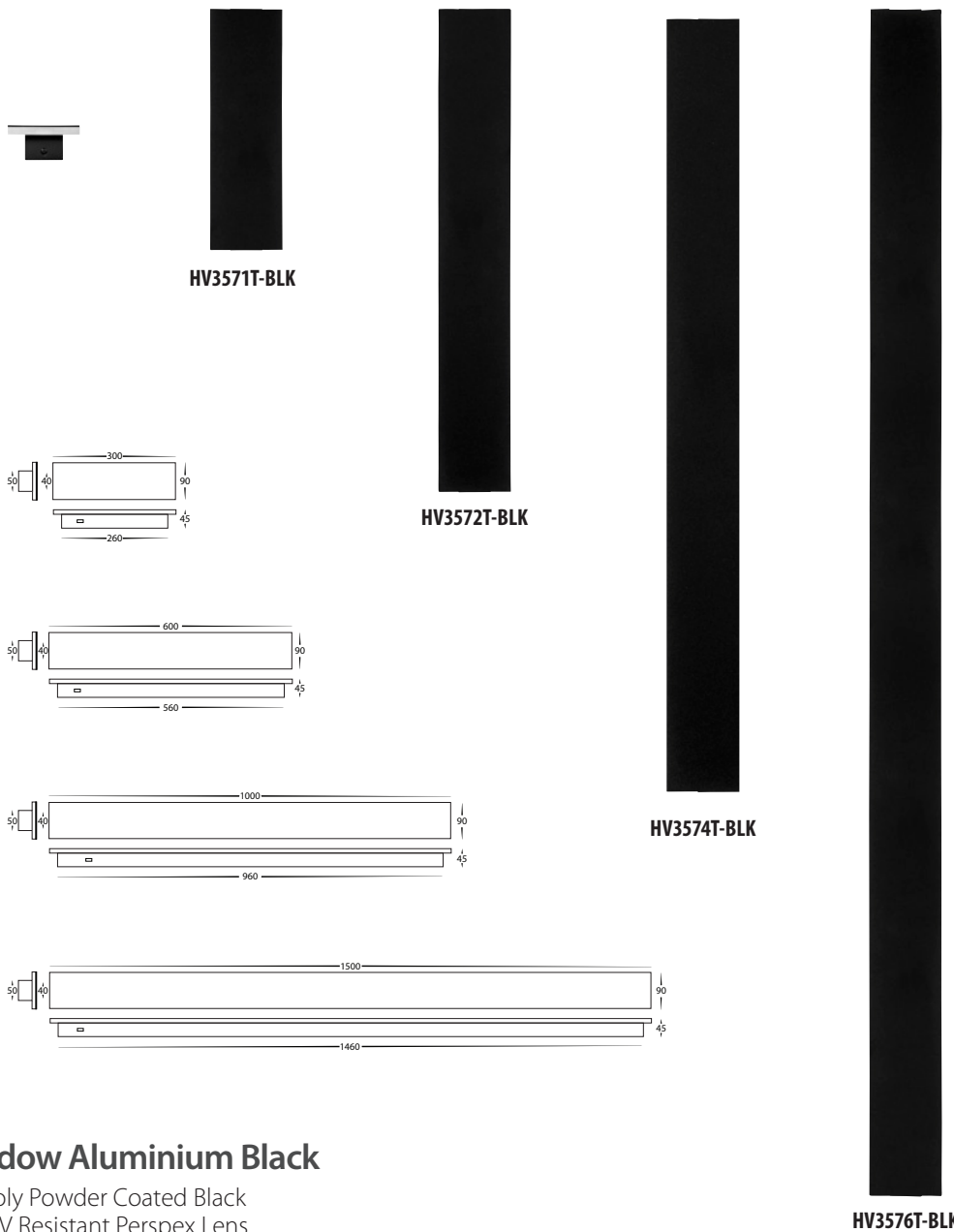

Barline Shadow Aluminium Black

- Aluminium Poly Powder Coated Black
- High Grade UV Resistant Perspex Lens
- Various lengths
- IP Rating: IP65

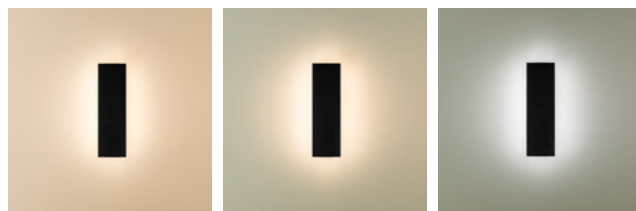
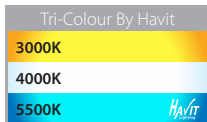

PART NUMBER	COLOUR TEMP	LUMENS	INPUT	INCLUDED LED
HV3571T-BLK	3000K - 4000K - 5500K	270lm - 540lm - 290lm	240v AC	Tri-Colour 4.5w-9w Built in LED 3000K = 4.5w - 4000K = 9w 5500K = 4.5w
HV3572T-BLK	3000K - 4000K - 5500K	540lm - 1080lm - 585lm	240v AC	Tri-Colour 9w-18w Built in LED 3000K = 9w - 4000K = 18w 5500K = 9w
HV3574T-BLK	3000K - 4000K - 5500K	900lm - 1800lm - 975lm	240v AC	Tri-Colour 15w-30w Built in LED 3000K = 15w 4000K = 30w 5500K = 15w
HV3576T-BLK	3000K - 4000K - 5500K	1380lm - 2700lm - 1495lm	240v AC	Tri-Colour 22w-45w Built in LED 3000K = 22w 4000K = 45w 5500K = 22w



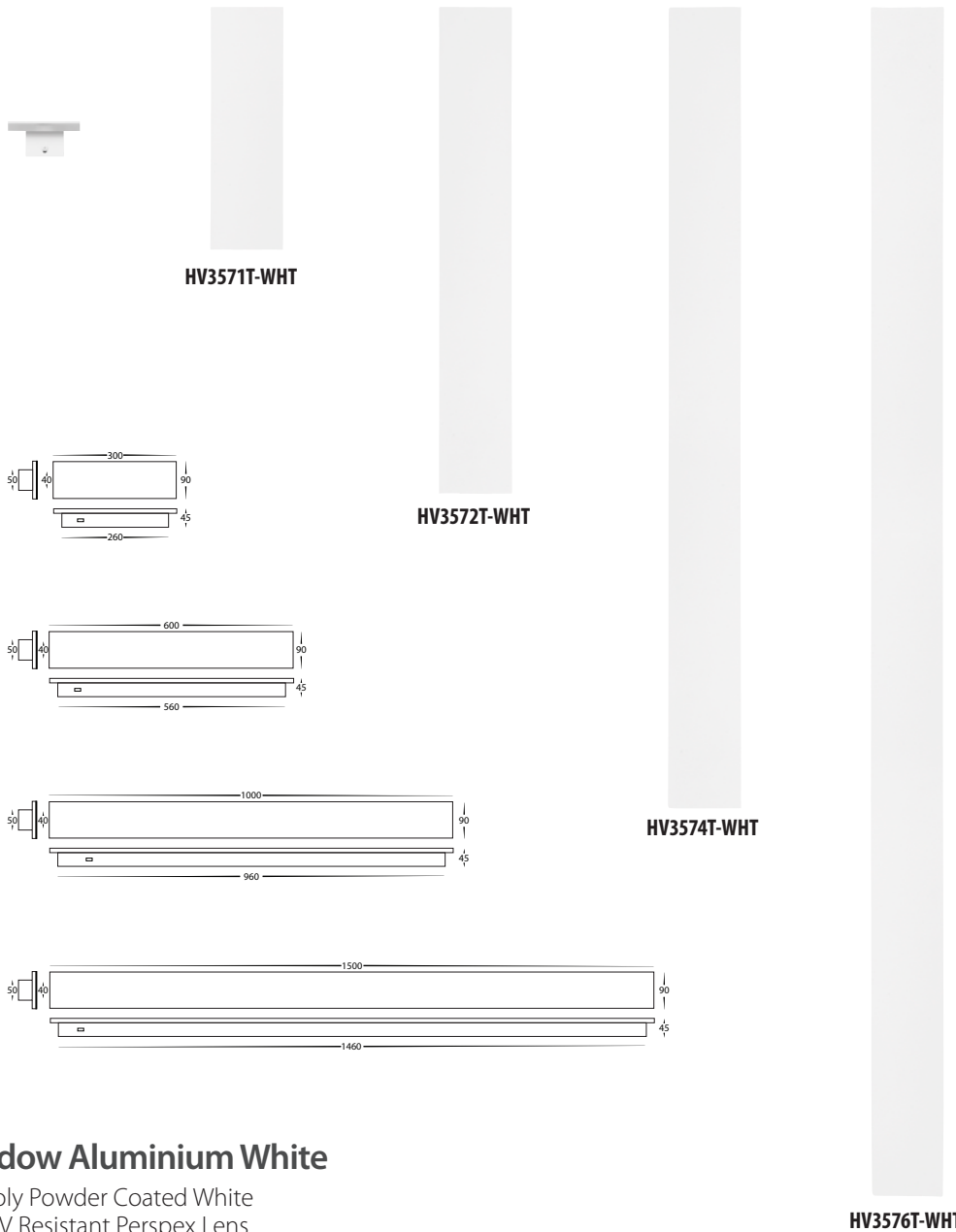

Barline Shadow Aluminium White

- Aluminium Poly Powder Coated White
- High Grade UV Resistant Perspex Lens
- Various lengths
- IP Rating: IP65

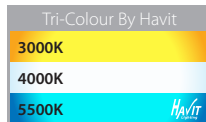

PART NUMBER	COLOUR TEMP	LUMENS	INPUT	INCLUDED LED
HV3571T-WHT	3000K - 4000K - 5500K	270lm - 540lm - 290lm	240v AC	Tri-Colour 4.5w-9w Built in LED 3k = 4.5w 4k = 9w 5k = 4.5w
HV3572T-WHT	3000K - 4000K - 5500K	540lm - 1080lm - 585lm	240v AC	Tri-Colour 4.5w-9w Built in LED 3k = 9w 4k = 18w 5k = 9w
HV3574T-WHT	3000K - 4000K - 5500K	900lm - 1800lm - 975lm	240v AC	Tri-Colour 4.5w-9w Built in LED 3k = 15w 4k = 30w 5k = 15w
HV3576T-WHT	3000K - 4000K - 5500K	1380lm - 2700lm - 1495lm	240v AC	Tri-Colour 4.5w-9w Built in LED 3k = 22w 4k = 45w 5k = 22w



For detailed product specifications
visit www.Havit.com.au
or scan this QR code

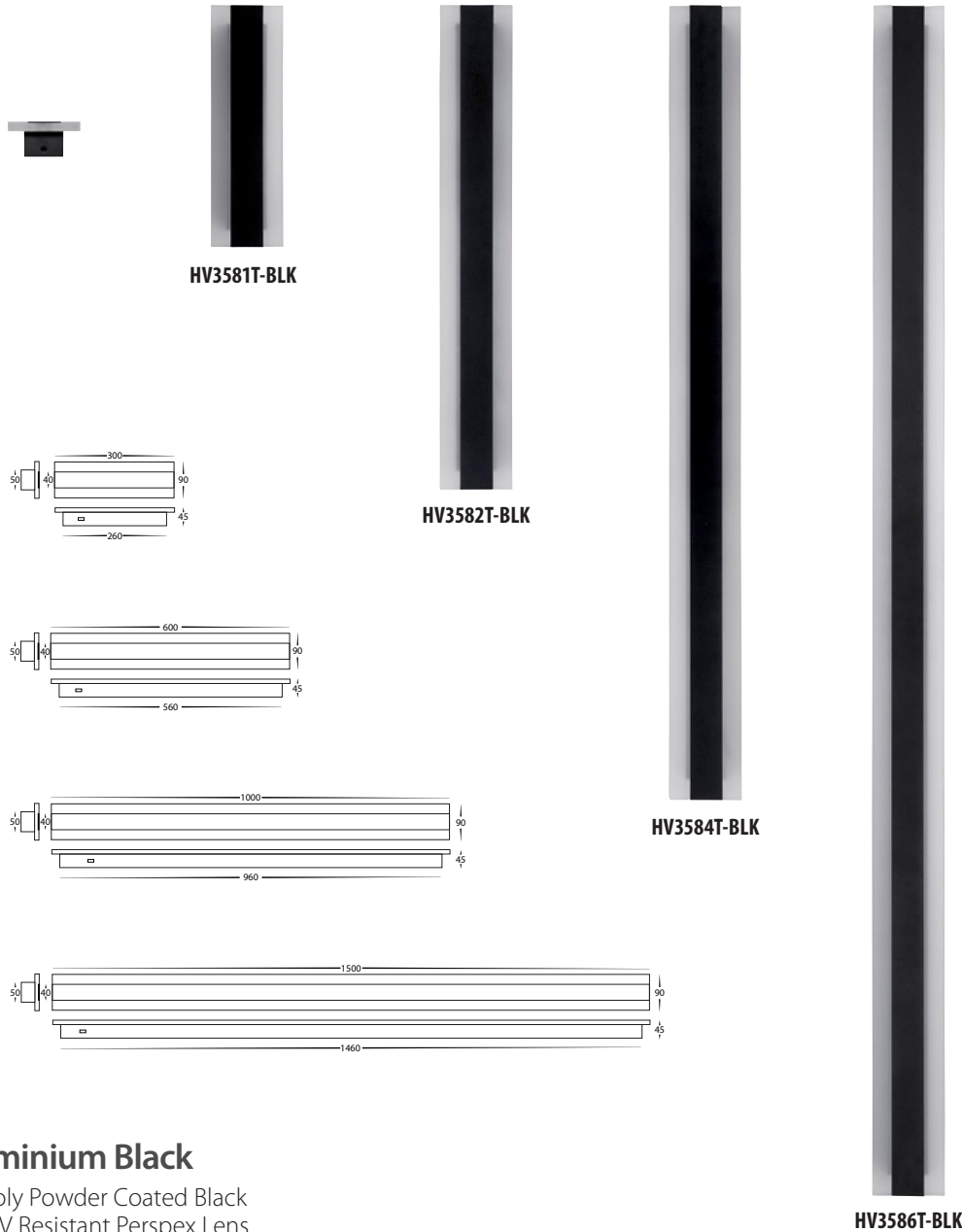

Barline Aluminium Black

- Aluminium Poly Powder Coated Black
- High Grade UV Resistant Perspex Lens
- Various lengths
- IP Rating: IP65

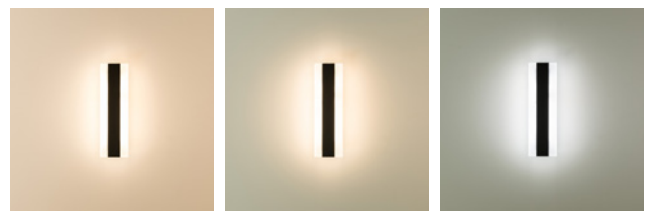
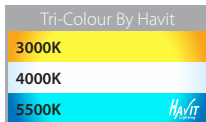

PART NUMBER	COLOUR TEMP	LUMENS	INPUT	INCLUDED LED
HV3581T-BLK	3000K - 4000K - 5500K	270lm - 540lm - 290lm	240v AC	Tri-Colour 4.5w-9w Built in LED 3000K = 4.5w - 4000K = 9w 5500K = 4.5w
HV3582T-BLK	3000K - 4000K - 5500K	540lm - 1080lm - 585lm	240v AC	Tri-Colour 9w-18w Built in LED 3000K = 9w - 4000K = 18w 5500K = 9w
HV3584T-BLK	3000K - 4000K - 5500K	900lm - 1800lm - 975lm	240v AC	Tri-Colour 15w-30w Built in LED 3000K = 15w 4000K = 30w 5500K = 15w
HV3586T-BLK	3000K - 4000K - 5500K	1380lm - 2700lm - 1495lm	240v AC	Tri-Colour 22w-45w Built in LED 3000K = 22w 4000K = 45w 5500K = 22w



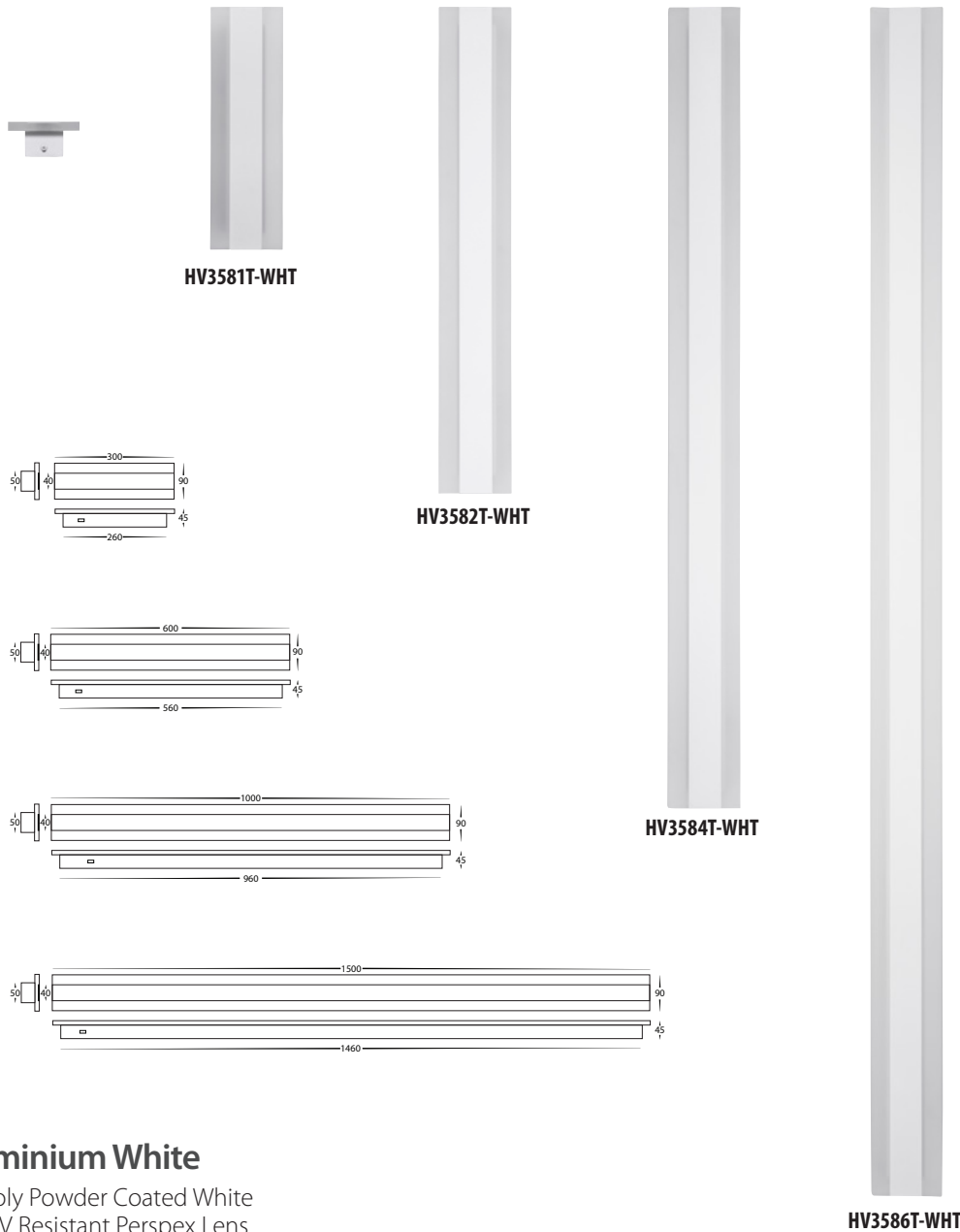

Barline Aluminium White

- Aluminium Poly Powder Coated White
- High Grade UV Resistant Perspex Lens
- Various lengths
- IP Rating: IP65

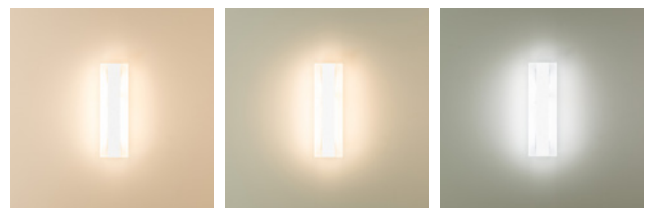
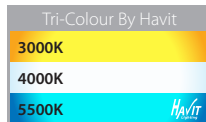

PART NUMBER	COLOUR TEMP	LUMENS	INPUT	INCLUDED LED
HV3581T-WHT	3000K - 4000K - 5500K	270lm - 540lm - 290lm	240v AC	Tri-Colour 4.5w-9w Built in LED 3k = 4.5w 4k = 9w 5k = 4.5w
HV3582T-WHT	3000K - 4000K - 5500K	540lm - 1080lm - 585lm	240v AC	Tri-Colour 4.5w-9w Built in LED 3k = 9w 4k = 18w 5k = 9w
HV3584T-WHT	3000K - 4000K - 5500K	900lm - 1800lm - 975lm	240v AC	Tri-Colour 4.5w-9w Built in LED 3k = 15w 4k = 30w 5k = 15w
HV3586T-WHT	3000K - 4000K - 5500K	1380lm - 2700lm - 1495lm	240v AC	Tri-Colour 4.5w-9w Built in LED 3k = 22w 4k = 45w 5k = 22w



For detailed product specifications
visit www.Havit.com.au
or scan this QR code



HV36051T-BLK

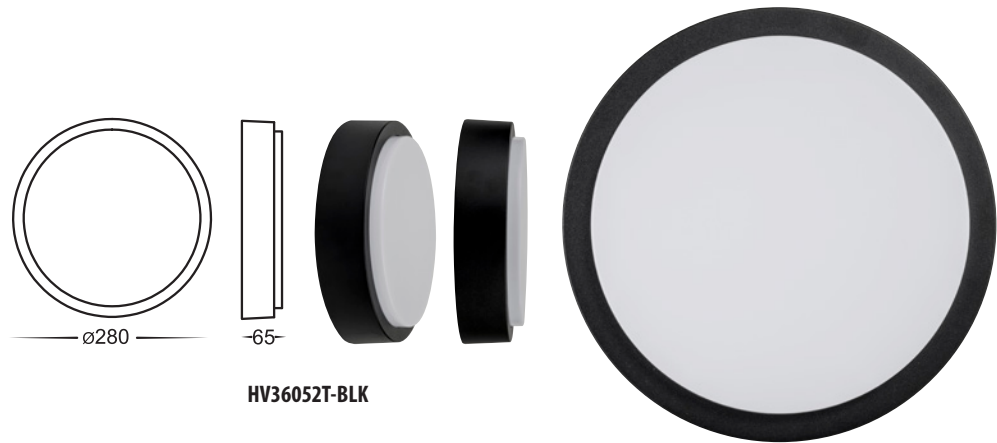

HV36052T-BLK

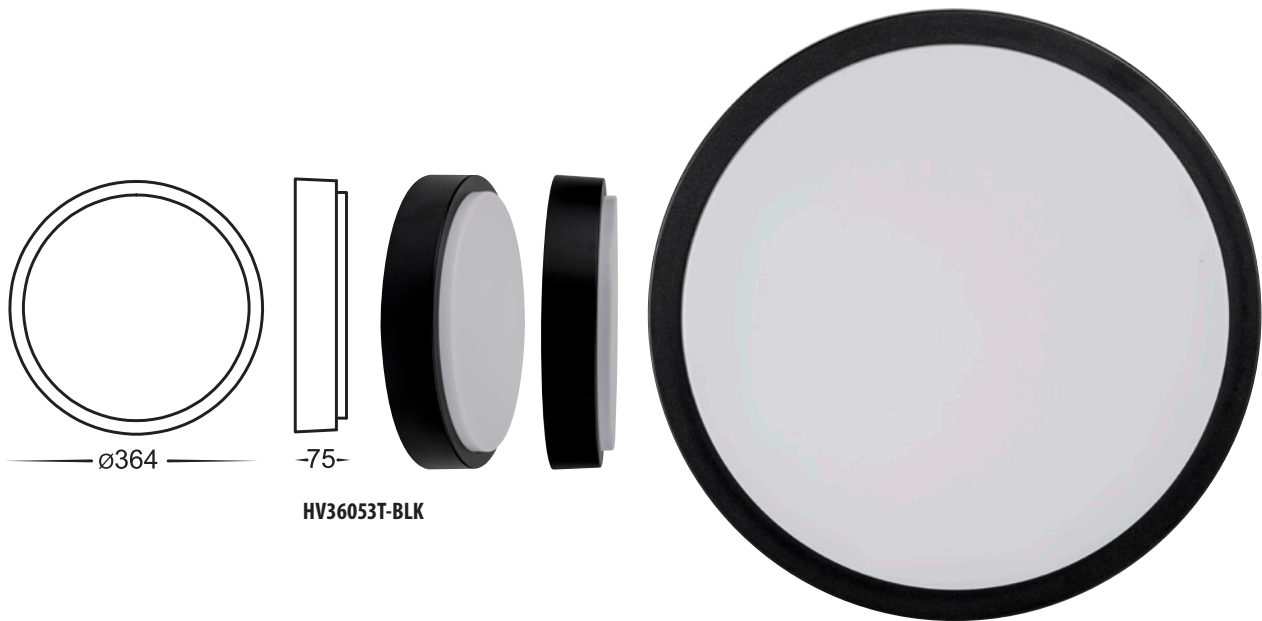

HV36053T-BLK

Liptor Aluminium Black

- Exterior Oyster Light
- Aluminum Poly Powder Coated Black
- Polycarbonate Opal Cover
- IP rating: IP54

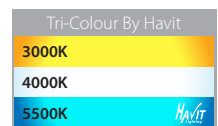

PART NUMBER	COLOUR TEMP	LUMENS	INPUT	INCLUDED LED
HV36051T-BLK	3000K - 4000K - 5500K	440lm - 480lm - 450lm	240V	Tri-Colour Built-in 10w LED
HV36052T-BLK	3000K - 4000K - 5500K	1130lm - 1360lm - 1310lm	240V	Tri-Colour Built-in 20w LED
HV36053T-BLK	3000K - 4000K - 5500K	1320lm - 1600lm - 1490lm	240V	Tri-Colour Built-in 30w LED



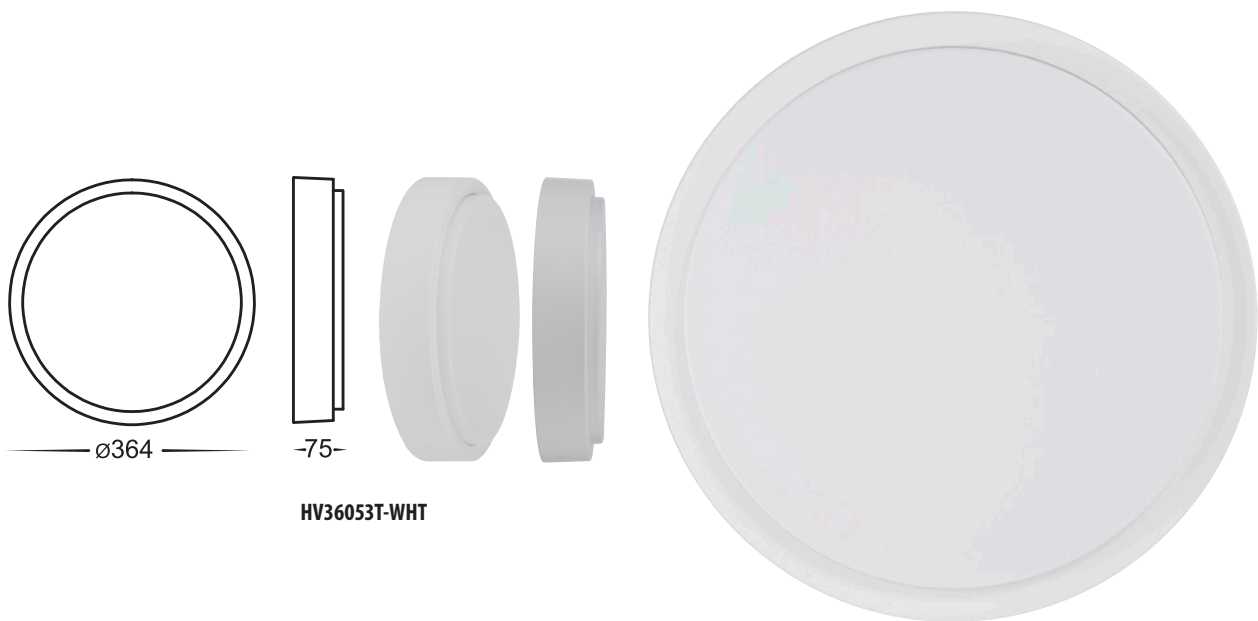
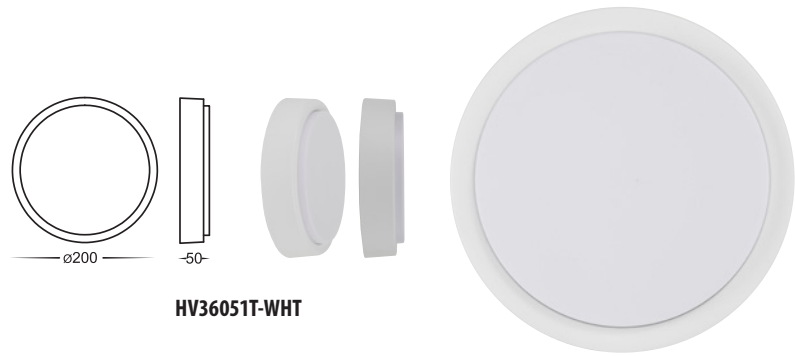

Liptor Aluminium White

- Exterior Oyster Light
- Aluminum Poly Powder Coated White
- Polycarbonate Opal Cover
- IP rating: IP54

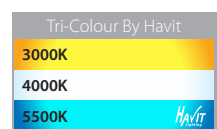

PART NUMBER	COLOUR TEMP	LUMENS	INPUT	INCLUDED LED
HV36051T-WHT	3000K - 4000K - 5500K	440lm - 480lm - 450lm	240V	Tri-Colour Built-in 10w LED
HV36052T-WHT	3000K - 4000K - 5500K	1130lm - 1360lm - 1310lm	240V	Tri-Colour Built-in 20w LED
HV36053T-WHT	3000K - 4000K - 5500K	1320lm - 1600lm - 1490lm	240V	Tri-Colour Built-in 30w LED



For detailed product specifications
visit www.Havit.com.au
or scan this QR code

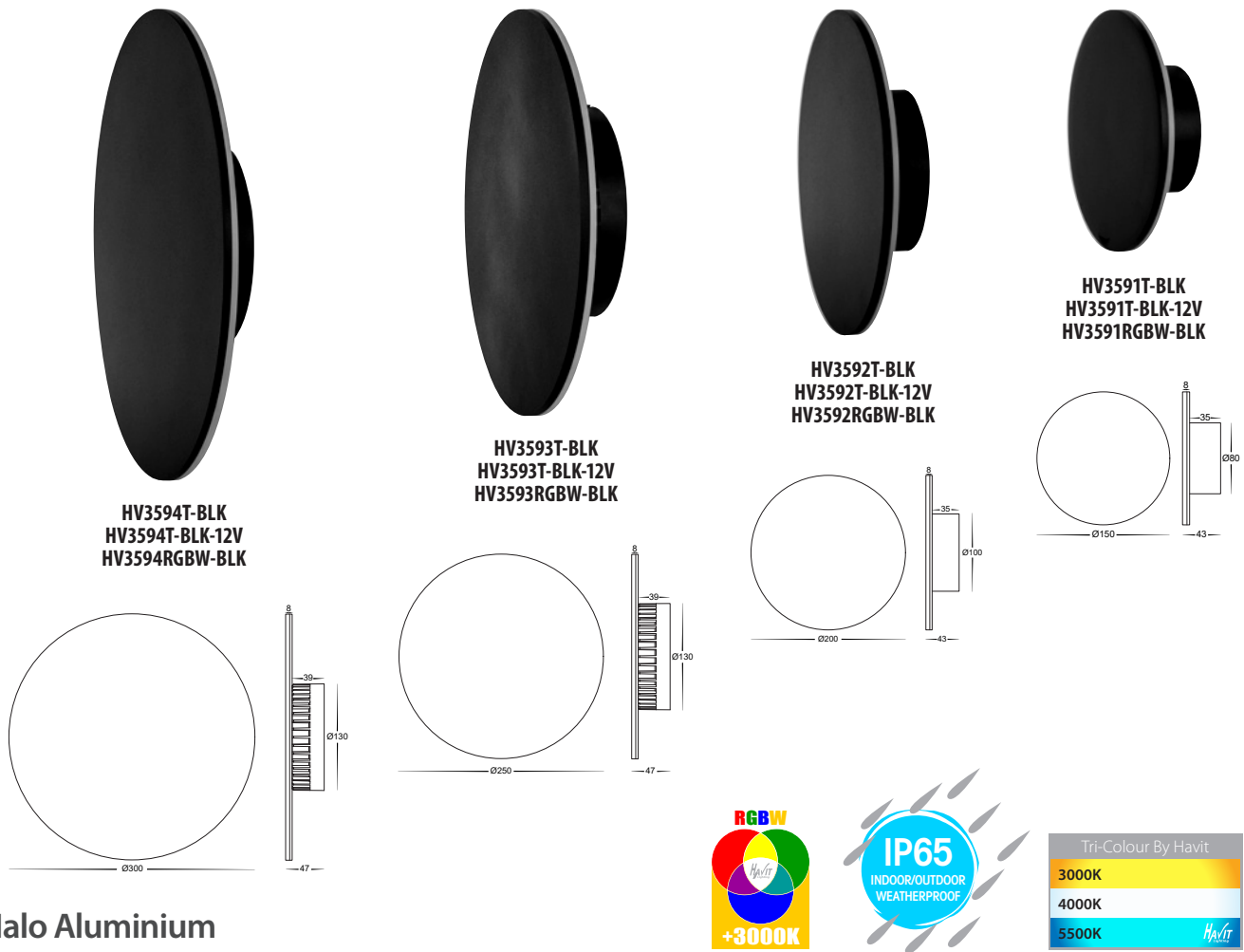

Halo Aluminium

- Indoor or Outdoor Wall Light
- Aluminium Poly Powder Coated Black
- Polycarbonate Diffuser
- Triac Dimmable - 240v Models Only
- RGBW Models controlled using APP or Remote
- IP Rating: IP65

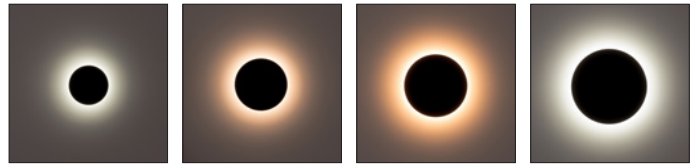

PART NUMBER	COLOUR TEMP	LUMENS	INPUT	INCLUDED LED
HV3591T-BLK	3000K - 4000K - 5500K	540lm - 550lm - 560lm	240V	Tri-Colour Built in 7w LED
HV3591T-BLK-12V	3000K - 4000K - 5500K	540lm - 550lm - 560lm	12v DC	Tri-Colour Built in 7w LED
HV3591RGBW-BLK	RGBW (RGB + 3000K)	250lm (3000K)	12v DC	RGBW Built in 7w LED
HV3592T-BLK	3000K - 4000K - 5500K	960lm - 1020lm - 1080lm	240V	Tri-Colour Built in 12w LED
HV3592T-BLK-12V	3000K - 4000K - 5500K	960lm - 1020lm - 1080lm	12v DC	Tri-Colour Built in 12w LED
HV3592RGBW-BLK	RGBW (RGB + 3000K)	300lm (3000K)	12v DC	RGBW Built in 12w LED
HV3593T-BLK	3000K - 4000K - 5500K	1315lm - 1380lm - 1440lm	240V	Tri-Colour Built in 18w LED
HV3593T-BLK-12V	3000K - 4000K - 5500K	1315lm - 1380lm - 1440lm	12v DC	Tri-Colour Built in 18w LED
HV3593RGBW-BLK	RGBW (RGB + 3000K)	350lm (3000K)	12v DC	RGBW Built in 18w LED
HV3594T-BLK	3000K - 4000K - 5500K	1920lm - 2040lm - 2160lm	240V	Tri-Colour Built in 24w LED
HV3594T-BLK-12V	3000K - 4000K - 5500K	1920lm - 2040lm - 2160lm	12v DC	Tri-Colour Built in 24w LED
HV3594RGBW-BLK	RGBW (RGB + 3000K)	400lm (3000K)	12v DC	RGBW Built in 24w LED

See pages 295-306 for compatible drivers. All low voltage products that specify an input of 12v or 24v DC must be used with a suitable LED driver.



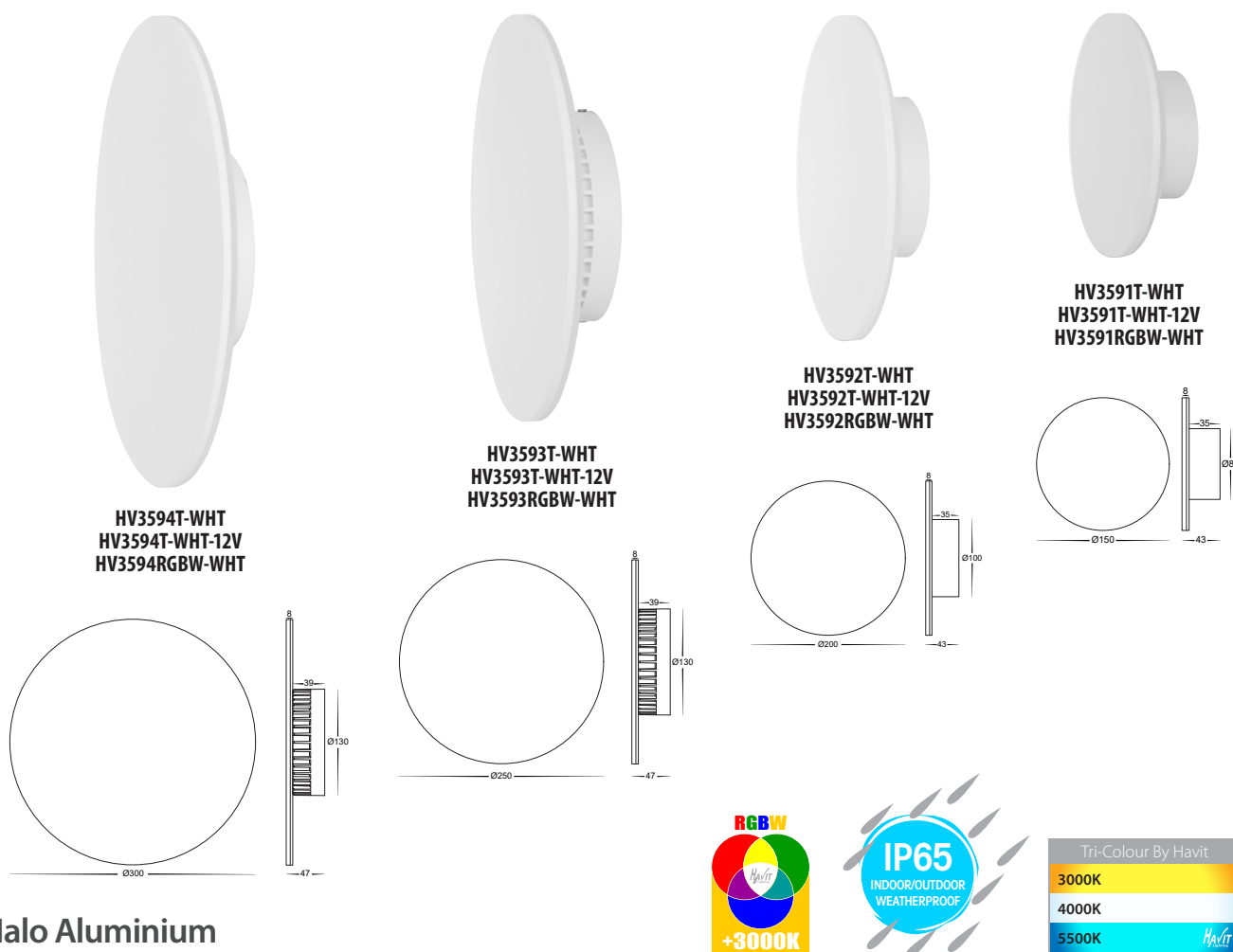

Halo Aluminium

- Indoor or Outdoor Wall Light
- Aluminium Poly Powder Coated White
- Polycarbonate Diffuser
- Triac Dimmable - 240v Models Only
- RGBW Models controlled using APP or Remote
- IP Rating: IP65

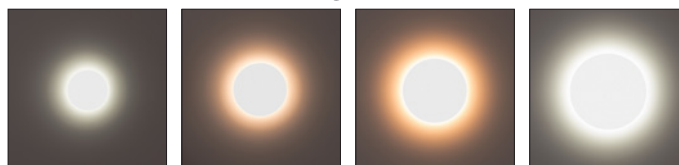

PART NUMBER	COLOUR TEMP	LUMENS	INPUT	INCLUDED LED
HV3591T-WHT	3000K - 4000K - 5500K	540lm - 550lm - 560lm	240V	Tri-Colour Built in 7w LED
HV3591T-WHT-12V	3000K - 4000K - 5500K	540lm - 550lm - 560lm	12v DC	Tri-Colour Built in 7w LED
HV3591RGBW-WHT	RGBW (RGB + 3000K)	250lm (3000K)	12v DC	RGBW Built in 7w LED
HV3592T-WHT	3000K - 4000K - 5500K	960lm - 1020lm - 1080lm	240V	Tri-Colour Built in 12w LED
HV3592T-WHT-12V	3000K - 4000K - 5500K	960lm - 1020lm - 1080lm	12v DC	Tri-Colour Built in 12w LED
HV3592RGBW-WHT	RGBW (RGB + 3000K)	300lm (3000K)	12v DC	RGBW Built in 12w LED
HV3593T-WHT	3000K - 4000K - 5500K	1315lm - 1380lm - 1440lm	240V	Tri-Colour Built in 18w LED
HV3593T-WHT-12V	3000K - 4000K - 5500K	1315lm - 1380lm - 1440lm	12v DC	Tri-Colour Built in 18w LED
HV3593RGBW-WHT	RGBW (RGB + 3000K)	350lm (3000K)	12v DC	RGBW Built in 18w LED
HV3594T-WHT	3000K - 4000K - 5500K	1920lm - 2040lm - 2160lm	240V	Tri-Colour Built in 24w LED
HV3594T-WHT-12V	3000K - 4000K - 5500K	1920lm - 2040lm - 2160lm	12v DC	Tri-Colour Built in 24w LED
HV3594RGBW-WHT	RGBW (RGB + 3000K)	400lm (3000K)	12v DC	RGBW Built in 24w LED

See pages 295-306 for compatible drivers. All low voltage products that specify an input of 12v or 24v DC must be used with a suitable LED driver.



For detailed product specifications
visit www.HavIt.com.au
or scan this QR code

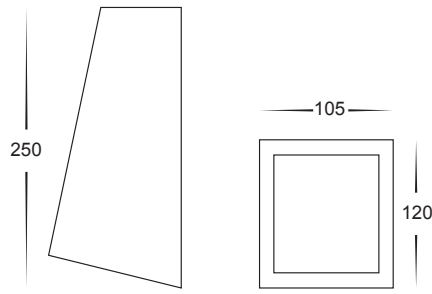

HV3601T-SS316



HV3602T-SS316 / HV3605T-SS316



HV3608C-SS316 / HV3608W-SS316

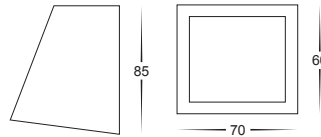
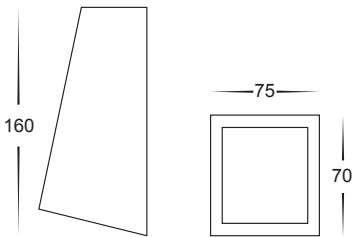

Taper 316 Stainless Steel

- Wall wedge
- 316 Stainless Steel Marine Grade
- Frosted tempered glass
- IP Rating: IP44

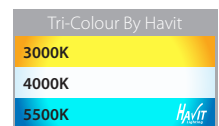

PART NUMBER	COLOUR TEMP	LUMENS	INPUT	INCLUDED LED
HV3601T-SS316	3000K - 4000K - 5500K	700lm - 720lm - 740lm	240v	Tri-Colour 9w E27 LED
HV3602T-SS316	3000K - 4000K - 5500K	270lm - 285lm - 300lm	240v	Tri-Colour 5w GU10 LED
HV3605T-SS316	3000K - 4000K - 5500K	270lm - 285lm - 300lm	12v DC	Tri-Colour 5w MR16 LED
HV3608C-SS316	5500K	110lm	12v DC	1.5w SMD G4 Bi pin
HV3608W-SS316	3000K	90lm	12v DC	1.5w SMD G4 Bi pin
HAVIT COMPATIBLE ACCESSORIES				
HV9507	3000K - 4000K - 5500K	240lm-630lm	12v DC	Tri-Colour 3W/5W/7W MR16 LED
HV9508	3000K - 4000K - 5500K	240lm-630lm	24v DC	Tri-Colour 3W/5W/7W MR16 LED
HV9506D	3000K - 4000K - 5500K	240lm-630lm	240v	Tri-Colour 3W/5W/7W GU10 LED

See pages 295-306 for compatible drivers. All low voltage products that specify an input of 12v or 24v DC must be used with a suitable LED driver.



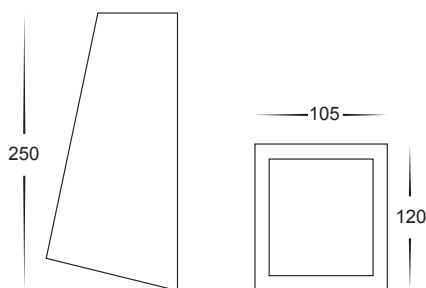

HV3601T-BLK



HV3602T-BLK / HV3605T-BLK



HV3608C-BLK / HV3608W-BLK

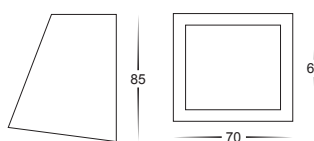
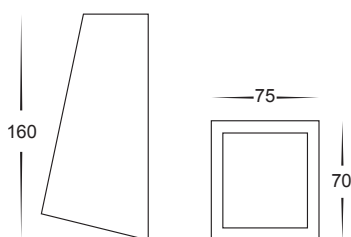

Taper Stainless Steel Black

- Wall wedge
- 316 Stainless Steel Poly Powder Coated Black
- Frosted tempered glass
- IP Rating: IP44

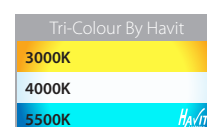

PART NUMBER	COLOUR TEMP	LUMENS	INPUT	INCLUDED LED
HV3601T-BLK	3000K - 4000K - 5500K	700lm - 720lm - 740lm	240v	Tri-Colour 9w E27 LED
HV3602T-BLK	3000K - 4000K - 5500K	270lm - 285lm - 300lm	240v	Tri-Colour 5w GU10 LED
HV3605T-BLK	3000K - 4000K - 5500K	270lm - 285lm - 300lm	12v DC	Tri-Colour 5w MR16 LED
HV3608C-BLK	5500K	110lm	12v DC	1.5w SMD G4 Bi pin
HV3608W-BLK	3000K	90lm	12v DC	1.5w SMD G4 Bi pin
HAVIT COMPATIBLE ACCESSORIES				
HV9507	3000K - 4000K - 5500K	240lm-630lm	12v DC	Tri-Colour 3W/5W/7W MR16 LED
HV9508	3000K - 4000K - 5500K	240lm-630lm	24v DC	Tri-Colour 3W/5W/7W MR16 LED
HV9506D	3000K - 4000K - 5500K	240lm-630lm	240v	Tri-Colour 3W/5W/7W GU10 LED

See pages 295-306 for compatible drivers. All low voltage products that specify an input of 12v or 24v DC must be used with a suitable LED driver.



For detailed product specifications
visit www.Havit.com.au
or scan this QR code

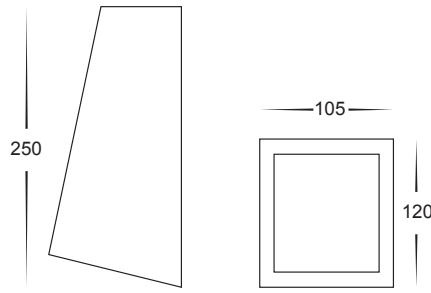

HV3601T-WHT



HV3602T-WHT / HV3605T-WHT



HV3608C-WHT / HV3608W-WHT

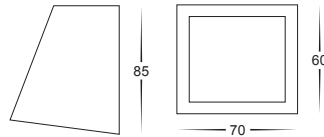
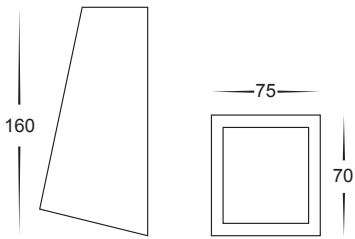

Taper Stainless Steel White

- Wall wedge
- 316 Stainless Steel Poly Powder Coated White
- Frosted tempered glass
- IP Rating: IP44

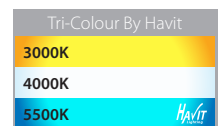

PART NUMBER	COLOUR TEMP	LUMENS	INPUT	INCLUDED LED
HV3601T-WHT	3000K - 4000K - 5500K	700lm - 720lm - 740lm	240v	Tri-Colour 9w E27 LED
HV3602T-WHT	3000K - 4000K - 5500K	270lm - 285lm - 300lm	240v	Tri-Colour 5w GU10 LED
HV3605T-WHT	3000K - 4000K - 5500K	270lm - 285lm - 300lm	12v DC	Tri-Colour 5w MR16 LED
HV3608C-WHT	5500K	110lm	12v DC	1.5w SMD G4 Bi pin
HV3608W-WHT	3000K	90lm	12v DC	1.5w SMD G4 Bi pin
HAVIT COMPATIBLE ACCESSORIES				
HV9507	3000K - 4000K - 5500K	240lm-630lm	12v DC	Tri-Colour 3W/5W/7W MR16 LED
HV9508	3000K - 4000K - 5500K	240lm-630lm	24v DC	Tri-Colour 3W/5W/7W MR16 LED
HV9506D	3000K - 4000K - 5500K	240lm-630lm	240v	Tri-Colour 3W/5W/7W GU10 LED

See pages 295-306 for compatible drivers. All low voltage products that specify an input of 12v or 24v DC must be used with a suitable LED driver.



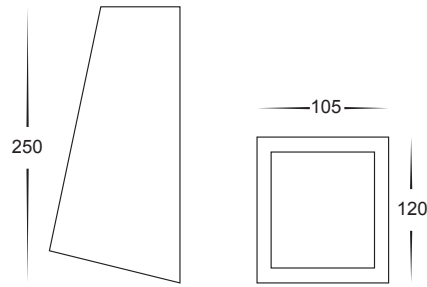

HV3601T-CP



HV3602T-CP / HV3605T-CP



HV3608C-CP / HV3608W-CP

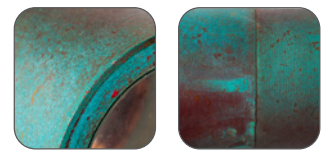
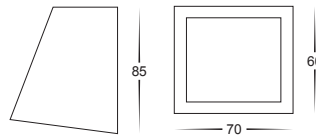
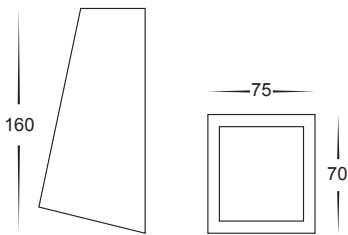

Weathered Copper

Taper Copper

- Wall wedge
- Copper body
- Frosted tempered glass
- Fast weathering for classic aged appearance
- IP Rating: IP44



Solid Brass and Solid Copper fittings will naturally tarnish. Solid Brass fittings with additional coloured coatings (Antique Brass & Graphite) may tarnish through the coating when installed in outdoor environments.

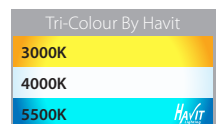

PART NUMBER	COLOUR TEMP	LUMENS	INPUT	INCLUDED LED
HV3601T-CP	3000K - 4000K - 5500K	700lm - 720lm - 740lm	240v	Tri-Colour 9w E27 LED
HV3602T-CP	3000K - 4000K - 5500K	270lm - 285lm - 300lm	240v	Tri-Colour 5w GU10 LED
HV3605T-CP	3000K - 4000K - 5500K	270lm - 285lm - 300lm	12v DC	Tri-Colour 5w MR16 LED
HV3608C-CP	5500K	110lm	12v DC	1.5w SMD G4 Bi pin
HV3608W-CP	3000K	90lm	12v DC	1.5w SMD G4 Bi pin
HAVIT COMPATIBLE ACCESSORIES				
HV9507	3000K - 4000K - 5500K	240lm-630lm	12v DC	Tri-Colour 3W/5W/7W MR16 LED
HV9508	3000K - 4000K - 5500K	240lm-630lm	24v DC	Tri-Colour 3W/5W/7W MR16 LED
HV9506D	3000K - 4000K - 5500K	240lm-630lm	240v	Tri-Colour 3W/5W/7W GU10 LED

See pages 295-306 for compatible drivers. All low voltage products that specify an input of 12v or 24v DC must be used with a suitable LED driver.



For detailed product specifications visit www.Havit.com.au or scan this QR code



HV3623T-BLK
Aluminium Black



HV3623T-WHT
Aluminium White

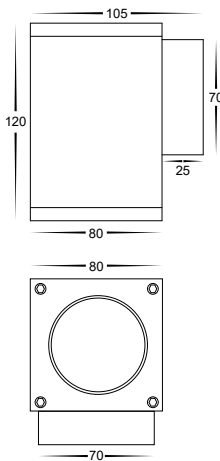

Quadru Aluminium

- Outdoor Fixed Down Wall Lights
- Aluminium Poly Powder Coated Black or White
- IP Rating: IP54

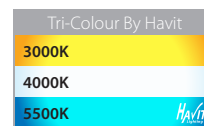

PART NUMBER	COLOUR TEMP	LUMENS	INPUT	INCLUDED LED
HV3623T-BLK	3000K - 4000K - 5500K	270lm - 285lm - 300lm	240v AC	Tri-Colour 5w GU10
HV3623T-WHT	3000K - 4000K - 5500K	270lm - 285lm - 300lm	240v AC	Tri-Colour 5w GU10





HV3624T-BLK
Aluminium Black



HV3624T-WHT
Aluminium White

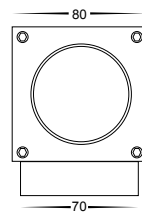
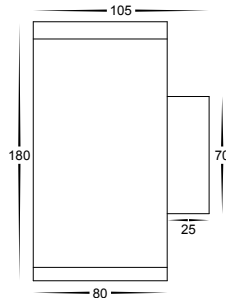

Quadru Aluminium

- Outdoor Up & Down Wall Lights
- Aluminium Poly Powder Coated Black or White
- IP Rating: IP54

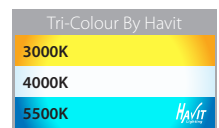

PART NUMBER	COLOUR TEMP	LUMENS	INPUT	INCLUDED LED
HV3624T-BLK	3000K - 4000K - 5500K	2x 270lm - 2x285lm - 2x 300lm	240v AC	Tri-Colour 2x 5w GU10
HV3624T-WHT	3000K - 4000K - 5500K	2x 270lm - 2x285lm - 2x 300lm	240v AC	Tri-Colour 2x 5w GU10



For detailed product specifications
visit www.Havit.com.au
or scan this QR code



HV3625T-AB
Antique Brass



HV3625T-PSS316
Polished 316 Stainless Steel



HV3625S-BR
Solid Brass



HV3625T-BLK
316 Stainless Steel Black



HV3625T-WHT
316 Stainless Steel White

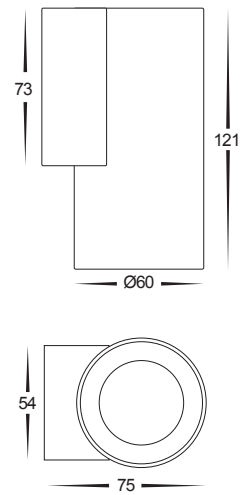

i Solid Brass and Solid Copper fittings will naturally tarnish. Solid Brass fittings with additional coloured coatings (Antique Brass & Graphite) may tarnish through the coating when installed in outdoor environments.

Aries

- Outdoor Fixed Down Wall Light
- Antique Brass, Polished 316 Stainless Steel, 316 Stainless Steel Black, 316 Stainless Steel White and Solid Brass
- IP Rating: IP65

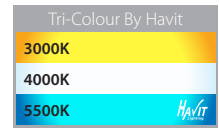

PART NUMBER	COLOUR TEMP	LUMENS	INPUT	INCLUDED LED
HV3625T-AB	3000K - 4000K - 5500K	448lm - 576lm - 534lm	240v	Tri-Colour Built in 6w LED
HV3625T-PSS316	3000K - 4000K - 5500K	448lm - 576lm - 534lm	240v	Tri-Colour Built in 6w LED
HV3625T-BLK	3000K - 4000K - 5500K	448lm - 576lm - 534lm	240v	Tri-Colour Built in 6w LED
HV3625T-WHT	3000K - 4000K - 5500K	448lm - 576lm - 534lm	240v	Tri-Colour Built in 6w LED
HV3625S-BR	2700K - 3000K - 4000K - 5000K - 5700K	615lm - 630lm - 700lm - 750lm - 790lm	240v	5-Colour Built in 6w LED





HV3626T-AB
Antique Brass



HV3626T-PSS316
Polished 316 Stainless Steel



HV3626S-BR
Solid Brass



HV3626T-BLK
316 Stainless Steel Black



HV3626T-WHT
316 Stainless Steel White

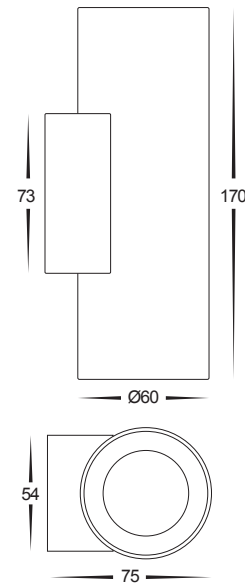

i Solid Brass and Solid Copper fittings will naturally tarnish. Solid Brass fittings with additional coloured coatings (Antique Brass & Graphite) may tarnish through the coating when installed in outdoor environments.

Aries

- Outdoor Up & Down Wall Light
- Antique Brass, Polished 316 Stainless Steel, 316 Stainless Steel Black, 316 Stainless Steel White and Solid Brass
- IP Rating: IP65

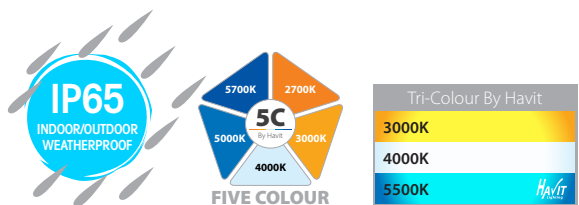

PART NUMBER	COLOUR TEMP	LUMENS	INPUT	INCLUDED LED
HV3626T-AB	3000K - 4000K - 5500K	2x 448lm - 2x 576lm - 2x 534lm	240v	Tri-Colour Built in 2x 6w LED
HV3626T-PSS316	3000K - 4000K - 5500K	2x 448lm - 2x 576lm - 2x 534lm	240v	Tri-Colour Built in 2x 6w LED
HV3626T-BLK	3000K - 4000K - 5500K	2x 448lm - 2x 576lm - 2x 534lm	240v	Tri-Colour Built in 2x 6w LED
HV3626T-WHT	3000K - 4000K - 5500K	2x 448lm - 2x 576lm - 2x 534lm	240v	Tri-Colour Built in 2x 6w LED
HV3626S-BR	2700K - 3000K - 4000K - 5000K - 5700K	2x400lm - 2x390lm - 2x425lm - 2x 450lm - 2x 465lm	240v	5-Colour Built in 2x 6w LED



For detailed product specifications visit www.Havit.com.au or scan this QR code



HV3625S-ALUBLK
Aluminium Black



HV3625S-ALUWHT
Aluminium White

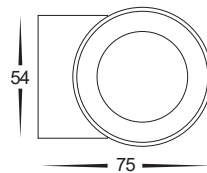
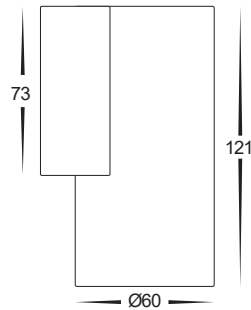

Aries Aluminium

- Outdoor Fixed Down Wall Lights
- Aluminium Poly Powder Coated Black or White
- Triac Dimmable
- IP Rating: IP65



PART NUMBER	COLOUR TEMP	LUMENS	INPUT	INCLUDED LED
HV3625S-ALUBLK	2700K - 3000K - 4000K - 5000K - 5700K	615lm - 630lm - 700lm - 750lm - 790lm	240v AC	5-Colour Built in 6w
HV3625S-ALUWHT	2700K - 3000K - 4000K - 5000K - 5700K	615lm - 630lm - 700lm - 750lm - 790lm	240v AC	5-Colour Built in 6w





HV3626S-ALUBLK
Aluminium Black



HV3626S-ALUWHT
Aluminium White

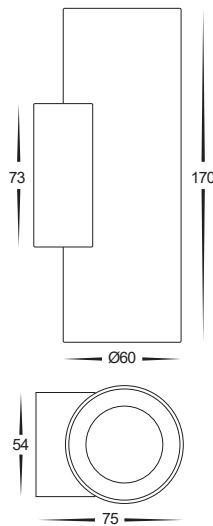

Aries Aluminium

- Outdoor Up & Down Wall Lights
- Aluminium Poly Powder Coated Black or White
- Triac Dimmable
- IP Rating: IP65



PART NUMBER	COLOUR TEMP	LUMENS	INPUT	INCLUDED LED
HV3626S-ALUBLK	2700K - 3000K - 4000K - 5000K - 5700K	2x 400lm - 2x 390lm - 2x 425lm - 2x 450lm - 2x 465lm	240v AC	5-Colour Built in 2x 6w
HV3626S-ALUWHT	2700K - 3000K - 4000K - 5000K - 5700K	2x 400lm - 2x 390lm - 2x 425lm - 2x 450lm - 2x 465lm	240v AC	5-Colour Built in 2x 6w



For detailed product specifications
visit www.Havit.com.au
or scan this QR code



HV3628T-BLK
Aluminium Black

Fixed Down



HV3628T-WHT
Aluminium White



HV3629T-BLK
Aluminium Black

Up & Down



HV3629T-WHT
Aluminium White

Porter Aluminium

- Large round wall pillar light
- Aluminium Poly Powder Coated Black or White
- Tempered glass
- Triac Dimmable
- IP Rating: IP54

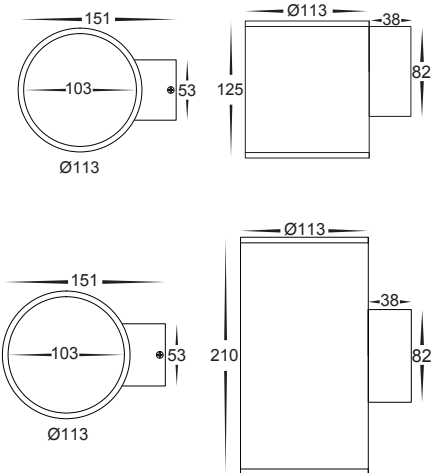
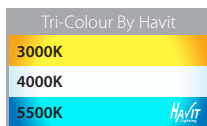

PART NUMBER	COLOUR TEMP	LUMENS	INPUT	INCLUDED LED
HV3628T-BLK	3000K - 4000K - 5500K	1200lm - 1275lm - 1350lm	240v	Tri-Colour Built-in 15w
HV3628T-WHT	3000K - 4000K - 5500K	1200lm - 1275lm - 1350lm	240v	Tri-Colour Built-in 15w
HV3629T-BLK	3000K - 4000K - 5500K	2x 1200lm - 2x 1275lm - 2x 1350lm	240v	Tri-Colour Built-in 2x 15w
HV3629T-WHT	3000K - 4000K - 5500K	2x 1200lm - 2x 1275lm - 2x 1350lm	240v	Tri-Colour Built-in 2x 15w





Fixed Down

HV3628T-BLK-SQ
Aluminium Black



HV3628T-WHT-SQ
Aluminium White



Up & Down

HV3629T-BLK-SQ
Aluminium Black



HV3629T-WHT-SQ
Aluminium White

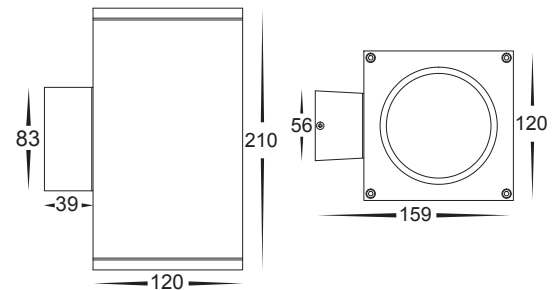
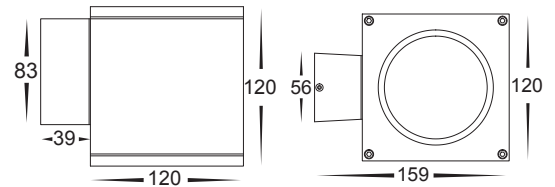

Porter Aluminium

- Large square wall pillar light
- Aluminium Poly Powder Coated Black or White
- Tempered glass
- Triac Dimmable
- IP Rating: IP54

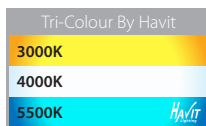

PART NUMBER	COLOUR TEMP	LUMENS	INPUT	INCLUDED LED
HV3628T-BLK-SQ	3000K - 4000K - 5500K	1200lm - 1275lm - 1350lm	240v	Tri-Colour Built-in 15w
HV3628T-WHT-SQ	3000K - 4000K - 5500K	1200lm - 1275lm - 1350lm	240v	Tri-Colour Built-in 15w
HV3629T-BLK-SQ	3000K - 4000K - 5500K	2x 1200lm - 2x 1275lm - 2x 1350lm	240v	Tri-Colour Built-in 2x 15w
HV3629T-WHT-SQ	3000K - 4000K - 5500K	2x 1200lm - 2x 1275lm - 2x 1350lm	240v	Tri-Colour Built-in 2x 15w



For detailed product specifications
visit www.Havit.com.au
or scan this QR code



Single Adjustable
HV3630T-BLK



Up & Down
HV3632T-BLK



Fixed Down
HV3631T-BLK

Accord Aluminium Black

- Square wall light
- Single adjustable, up & down or fixed down
- Aluminium Poly Powder Coated Black
- Tempered glass
- IP Rating: IP54

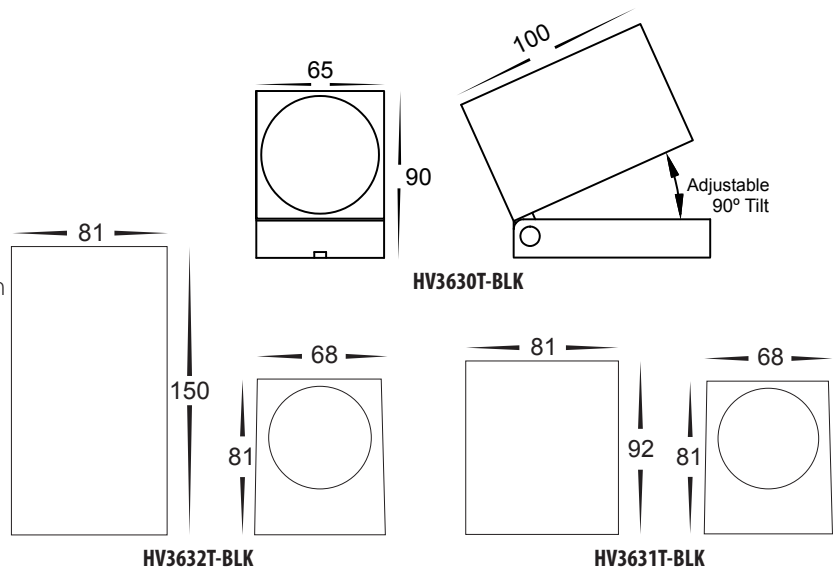
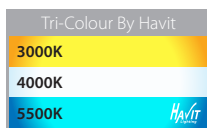

PART NUMBER	COLOUR TEMP	LUMENS	INPUT	INCLUDED LED
HV3630T-BLK	3000K - 4000K - 5500K	270lm - 285lm - 300lm	240v	Tri-Colour 5w GU10 LED
HV3631T-BLK	3000K - 4000K - 5500K	270lm - 285lm - 300lm	240v	Tri-Colour 5w GU10 LED
HV3632T-BLK	3000K - 4000K - 5500K	2x 270lm - 2x 285lm - 2x 300lm	240v	Tri-Colour 2x 5w GU10 LED





**Single Adjustable
HV3630T-WHT**



**Up & Down
HV3632T-WHT**



**Fixed Down
HV3631T-WHT**

Accord Aluminium White

- Square wall light
- Single adjustable, up & down or fixed down
- Aluminium Poly Powder Coated White
- Tempered glass
- IP Rating: IP54

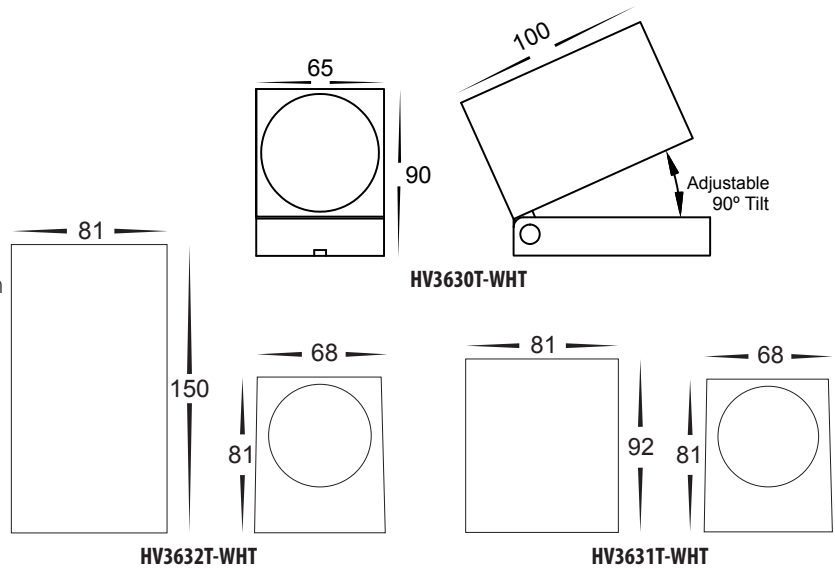
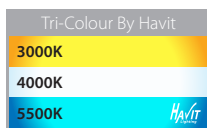

PART NUMBER	COLOUR TEMP	LUMENS	INPUT	INCLUDED LED
HV3630T-WHT	3000K - 4000K - 5500K	270lm - 285lm - 300lm	240v	Tri-Colour 5w GU10 LED
HV3631T-WHT	3000K - 4000K - 5500K	270lm - 285lm - 300lm	240v	Tri-Colour 5w GU10 LED
HV3632T-WHT	3000K - 4000K - 5500K	2x 270lm - 2x 285lm - 2x 300lm	240v	Tri-Colour 2x 5w GU10 LED



For detailed product specifications
visit www.Havit.com.au
or scan this QR code





HV3633T-SS316
316 Stainless Steel



HV3633T-BLK
Stainless Steel Black



HV3633T-WHT
Stainless Steel White

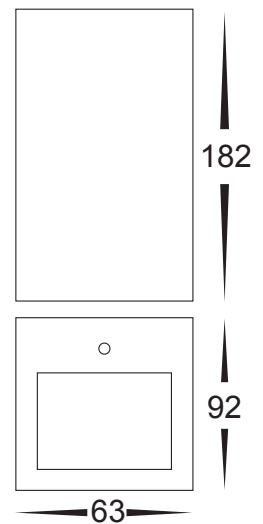

Veldi

- Square up & down wall pillar light
- 316 Stainless Steel and Powder Coated 316 Stainless Steel Black & White
- Tempered glass
- IP Rating: IP54

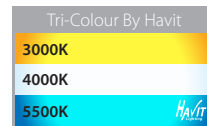

PART NUMBER	COLOUR TEMP	LUMENS	INPUT	INCLUDED LED
HV3633T-SS316	3000K - 4000K - 5500K	2x 270lm - 2x 285lm - 2x 300lm	240v	Tri-Colour 2x 5w GU10 LED
HV3633T-BLK	3000K - 4000K - 5500K	2x 270lm - 2x 285lm - 2x 300lm	240v	Tri-Colour 2x 5w GU10 LED
HV3633T-WHT	3000K - 4000K - 5500K	2x 270lm - 2x 285lm - 2x 300lm	240v	Tri-Colour 2x 5w GU10 LED
HAVIT COMPATIBLE ACCESSORIES				
HV9506D	3000K - 4000K - 5500K	240lm-630lm	240v	Tri-Colour 3W/5W/7W



For detailed product specifications
visit www.Havit.com.au
or scan this QR code



HV3635T-BLK
Aluminium Black



HV3635T-WHT
Aluminium White

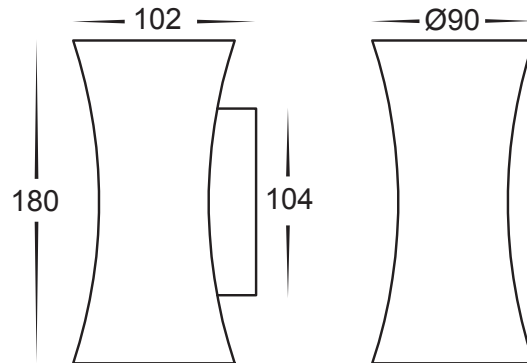

Base Width = 61mm

Savannah Aluminium

- Up & Down wall light
- Aluminium Poly Powder Coated Black and White
- Tempered glass
- IP Rating: IP54

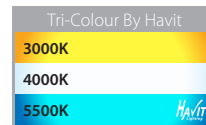

PART NUMBER	COLOUR TEMP	LUMENS	INPUT	INCLUDED LED
HV3635T-BLK	3000K - 4000K - 5500K	2x 225lm - 2x 230lm - 2x 235lm	240v	Tri-Colour Built-in 2x 4.5w LED
HV3635T-WHT	3000K - 4000K - 5500K	2x 225lm - 2x 230lm - 2x 235lm	240v	Tri-Colour Built-in 2x 4.5w LED





HV3637T-BLK
Aluminium Black

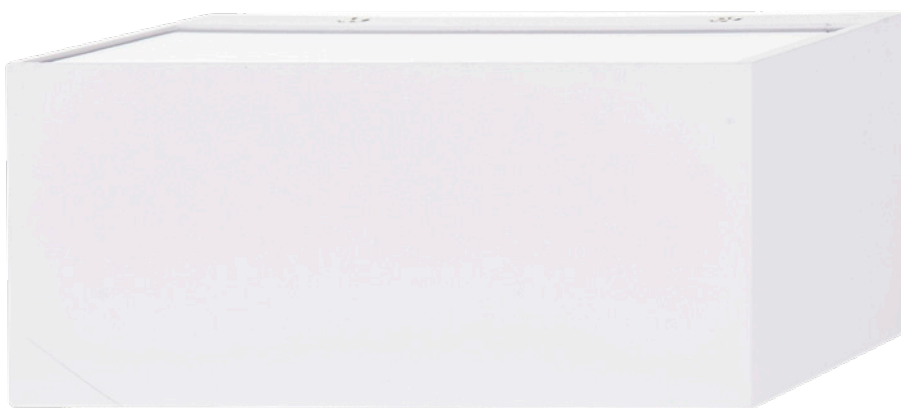

HV3637T-WHT
Aluminium White

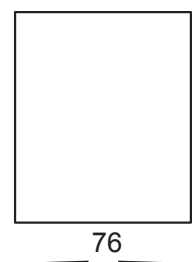
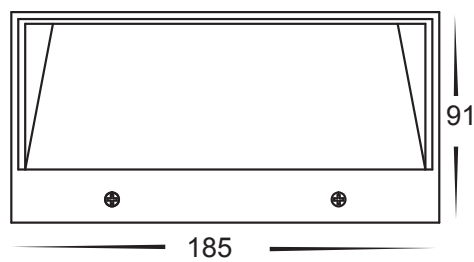

Nikki Aluminium

- Up & Down wall light
- Aluminium Poly Powder Coated Black and White
- Tempered glass
- IP Rating: IP54

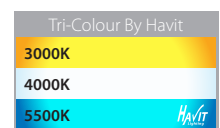

PART NUMBER	COLOUR TEMP	LUMENS	INPUT	INCLUDED LED
HV3637T-BLK	3000K - 4000K - 5500K	2x 375lm - 2x 400lm - 2x 425lm	240v	Tri-Colour Built-in 10w LED
HV3637T-WHT	3000K - 4000K - 5500K	2x 375lm - 2x 400lm - 2x 425lm	240v	Tri-Colour Built-in 10w LED



For detailed product specifications
visit www.Havit.com.au
or scan this QR code



HV3639T-BLK
Aluminium Black



HV3639T-WHT
Aluminium White

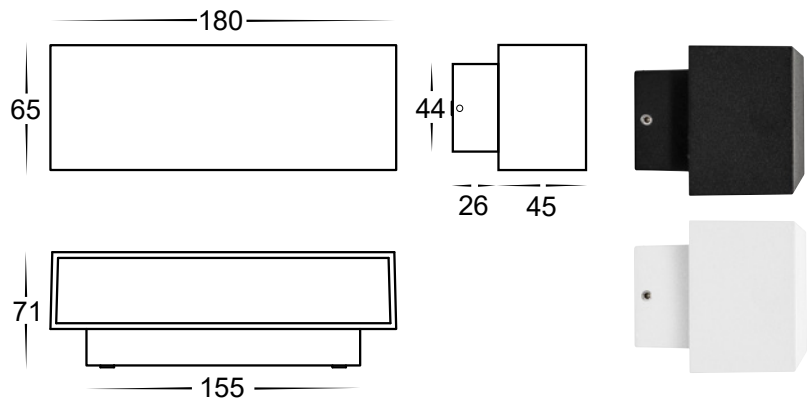

Blokk Aluminium

- Up & Down wall light
- Aluminium Poly Powder Coated Black or White
- Frosted tempered glass
- IP Rating: IP54

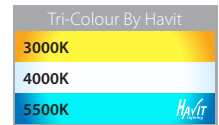

PART NUMBER	COLOUR TEMP	LUMENS	INPUT	INCLUDED LED
HV3639T-BLK	3000K - 4000K - 5500K	2x 300lm - 2x 310lm - 2x 320lm	240V	Tri-Colour Built-in 2x 4.5w LED
HV3639T-WHT	3000K - 4000K - 5500K	2x 300lm - 2x 310lm - 2x 320lm	240V	Tri-Colour Built-in 2x 4.5w LED



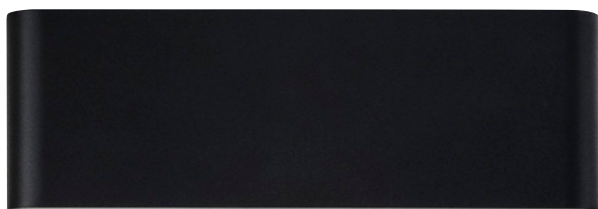

Fixed Down
HV3652T-BLK-240V
HV3652T-BLK-12V
Aluminium Black

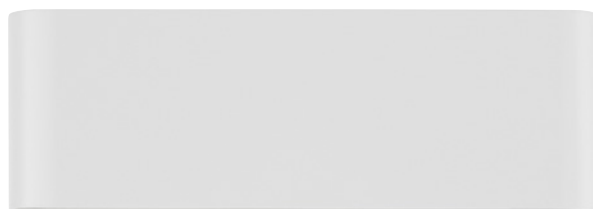
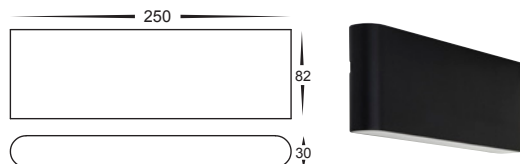

Fixed Down
HV3652T-WHT-240V
HV3652T-WHT-12V
Aluminium White

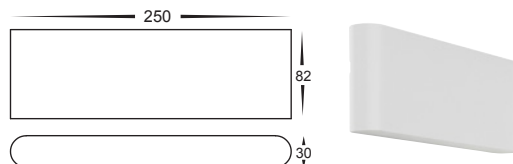

Up & Down
HV3653T-BLK-240V
HV3653T-BLK-12V
Aluminium Black

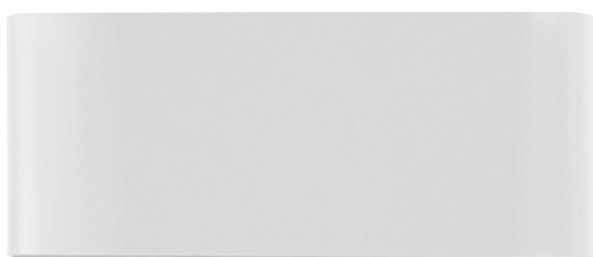
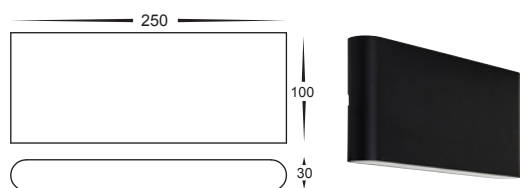

Up & Down
HV3653T-WHT-240V
HV3653T-WHT-12V
Aluminium White

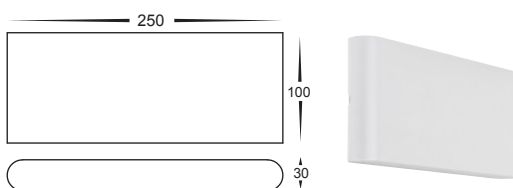

Lisse Aluminium

- Outdoor Wall Light
- Fixed down or up & down lighting
- Aluminium Poly Powder Coated Black or White
- Frosted Tempered Glass
- IP Rating: IP54

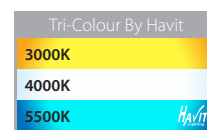

PART NUMBER	COLOUR TEMP	LUMENS	INPUT	INCLUDED LED
HV3652T-BLK-240V	3000K - 4000K - 5500K	475lm - 560lm - 515lm	240v	Tri-Colour Built-in 12w LED
HV3652T-BLK-12V	3000K - 4000K - 5500K	475lm - 560lm - 515lm	12v DC	Tri-Colour Built-in 12w LED
HV3652T-WHT-240V	3000K - 4000K - 5500K	475lm - 560lm - 515lm	240v	Tri-Colour Built-in 12w LED
HV3652T-WHT-12V	3000K - 4000K - 5500K	475lm - 560lm - 515lm	12v DC	Tri-Colour Built-in 12w LED
HV3653T-BLK-240V	3000K - 4000K - 5500K	2x 475lm - 2x 560lm - 2x 515lm	240v	Tri-Colour Built-in 2x 12w LED
HV3653T-BLK-12V	3000K - 4000K - 5500K	2x 475lm - 2x 560lm - 2x 515lm	12v DC	Tri-Colour Built-in 2x 12w LED
HV3653T-WHT-240V	3000K - 4000K - 5500K	2x 475lm - 2x 560lm - 2x 515lm	240v	Tri-Colour Built-in 2x 12w LED
HV3653T-WHT-12V	3000K - 4000K - 5500K	2x 475lm - 2x 560lm - 2x 515lm	12v DC	Tri-Colour Built-in 2x 12w LED

See pages 295-306 for compatible drivers. All low voltage products that specify an input of 12v or 24v DC must be used with a suitable LED driver.



For detailed product specifications
 visit www.Havit.com.au
 or scan this QR code



Fixed Down
HV3641T-BLK-240V
HV3641T-BLK-12V

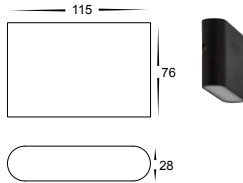

Up & Down
HV3642T-BLK-240V
HV3642T-BLK-12V

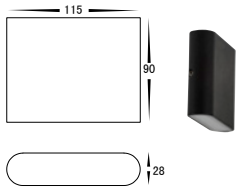

Fixed Down
HV3643T-BLK-240V
HV3643T-BLK-12V
HV3643RGBW-BLK

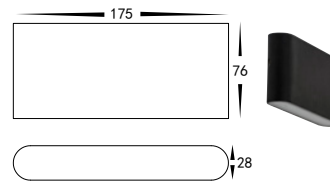

Up & Down
HV3644T-BLK-240V
HV3644T-BLK-12V
HV3644RGBW-BLK

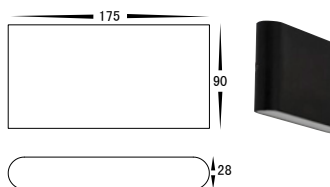

Lisse Aluminium Black

- Slim wall light Fixed down or up & down lighting
- Aluminium Poly Powder Coated Black
- Tempered glass
- IP Rating: IP54

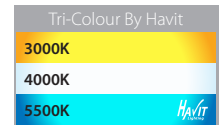

PART NUMBER	COLOUR TEMP	LUMENS	INPUT	INCLUDED LED
HV3641T-BLK-240V	3000K - 4000K - 5500K	240lm - 250lm - 260lm	240v	Tri-Colour Built-in 4w LED
HV3641T-BLK-12V	3000K - 4000K - 5500K	240lm - 250lm - 260lm	12v DC	Tri-Colour Built-in 4w LED
HV3642T-BLK-240V	3000K - 4000K - 5500K	2x 180lm - 2x 187lm - 2x 195lm	240v	Tri-Colour Built-in 2x 3w LED
HV3642T-BLK-12V	3000K - 4000K - 5500K	2x 180lm - 2x 187lm - 2x 195lm	12v DC	Tri-Colour Built-in 2x 3w LED
HV3643T-BLK-240V	3000K - 4000K - 5500K	360lm - 375lm - 390lm	240v	Tri-Colour Built-in 6w LED
HV3643T-BLK-12V	3000K - 4000K - 5500K	360lm - 375lm - 390lm	12v DC	Tri-Colour Built-in 6w LED
HV3643RGBW-BLK	RGB + 3000K	160lm (3000K)	12v DC	RGBW Built-in 6w LED
HV3644T-BLK-240V	3000K - 4000K - 5500K	2x 300lm - 2x 310lm - 2x 325lm	240v	Tri-Colour Built-in 2x 5w LED
HV3644T-BLK-12V	3000K - 4000K - 5500K	2x 300lm - 2x 310lm - 2x 325lm	12v DC	Tri-Colour Built-in 2x 5w LED
HV3644RGBW-BLK	RGB + 3000K	2x 180lm (3000K)	12v DC	RGBW Built-in 2x 5w LED

HAVIT COMPATIBLE ACCESSORIES

See pages 295-306 for compatible drivers. All low voltage products that specify an input of 12v or 24v DC must be used with a suitable LED driver.

RGBW Models can be used with any RGBW Controller in LED Controller section of this catalogue.



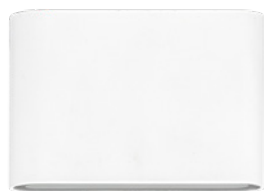

Fixed Down
HV3641T-WHT-240V
HV3641T-WHT-12V

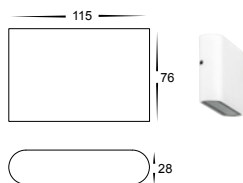

Up & Down
HV3642T-WHT-240V
HV3642T-WHT-12V

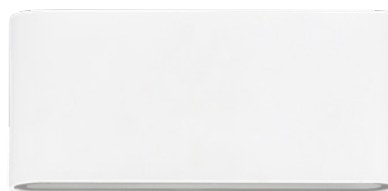
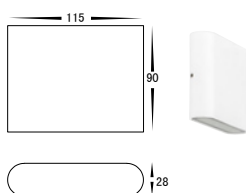

Fixed Down
HV3643T-WHT-240V
HV3643T-WHT-12V
HV3643RGBW-WHT

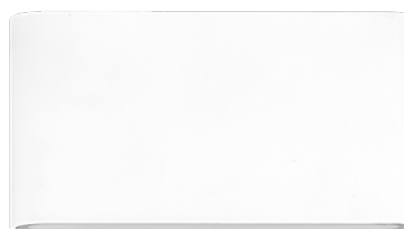
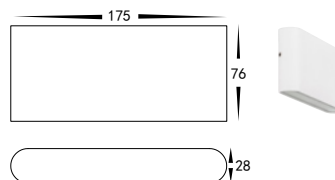

Up & Down
HV3644T-WHT-240V
HV3644T-WHT-12V
HV3644RGBW-WHT

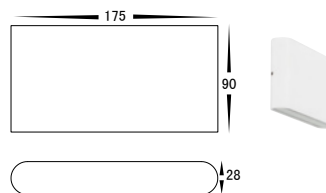

Lisse Aluminium White

- Slim wall light Fixed down or up & down lighting
- Aluminium Poly Powder Coated White
- Tempered glass
- IP Rating: IP54

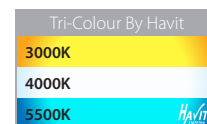

PART NUMBER	COLOUR TEMP	LUMENS	INPUT	INCLUDED LED
HV3641T-WHT-240V	3000K - 4000K - 5500K	240lm - 250lm - 260lm	240v	Tri-Colour Built-in 4w LED
HV3641T-WHT-12V	3000K - 4000K - 5500K	240lm - 250lm - 260lm	12v DC	Tri-Colour Built-in 4w LED
HV3642T-WHT-240V	3000K - 4000K - 5500K	2x 180lm - 2x 187lm - 2x 195lm	240v	Tri-Colour Built-in 2x 3w LED
HV3642T-WHT-12V	3000K - 4000K - 5500K	2x 180lm - 2x 187lm - 2x 195lm	12v DC	Tri-Colour Built-in 2x 3w LED
HV3643T-WHT-240V	3000K - 4000K - 5500K	360lm - 375lm - 390lm	240v	Tri-Colour Built-in 6w LED
HV3643T-WHT-12V	3000K - 4000K - 5500K	360lm - 375lm - 390lm	12v DC	Tri-Colour Built-in 6w LED
HV3643RGBW-WHT	RGB + 3000K	160lm (3000K)	12v DC	RGBW Built-in 6w LED
HV3644T-WHT-240V	3000K - 4000K - 5500K	2x 300lm - 2x 310lm - 2x 325lm	240v	Tri-Colour Built-in 2x 5w LED
HV3644T-WHT-12V	3000K - 4000K - 5500K	2x 300lm - 2x 310lm - 2x 325lm	12v DC	Tri-Colour Built-in 2x 5w LED
HV3644RGBW-WHT	RGB + 3000K	2x 180lm (3000K)	12v DC	RGBW Built-in 2x 5w LED

HAVIT COMPATIBLE ACCESSORIES

See pages 295-306 for compatible drivers. All low voltage products that specify an input of 12v or 24v DC must be used with a suitable LED driver.

RGBW Models can be used with any RGBW Controller in LED Controller section of this catalogue.



For detailed product specifications
 visit www.Havit.com.au
 or scan this QR code



Fixed Down
HV3645T-BLK-240V
HV3645T-BLK-12V

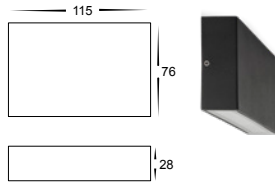

Fixed Down
HV3647T-BLK-240V
HV3647T-BLK-12V

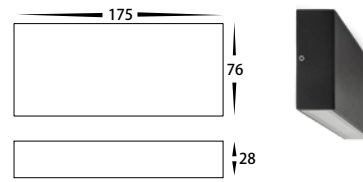

Up & Down
HV3646T-BLK-240V
HV3646T-BLK-12V

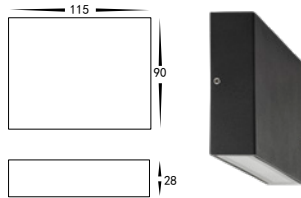

Up & Down
HV3648T-BLK-240V
HV3648T-BLK-12V

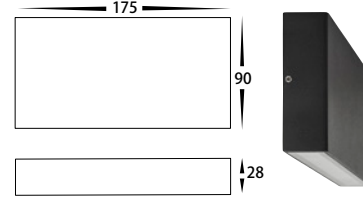

Essil Aluminium Black

- Slim wall light Fixed down or up & down lighting
- Aluminium Poly Powder Coated Black
- Tempered glass
- IP Rating: IP54

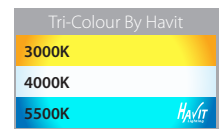

PART NUMBER	COLOUR TEMP	LUMENS	INPUT	INCLUDED LED
HV3645T-BLK-240V	3000K - 4000K - 5500K	240lm - 250lm - 260lm	240v	Tri-Colour Built-in 4w LED
HV3645T-BLK-12V	3000K - 4000K - 5500K	240lm - 250lm - 260lm	12v DC	Tri-Colour Built-in 4w LED
HV3646T-BLK-240V	3000K - 4000K - 5500K	2x 180lm - 2x 187lm - 2x 195lm	240v	Tri-Colour Built-in 2x 3w LED
HV3646T-BLK-12V	3000K - 4000K - 5500K	2x 180lm - 2x 187lm - 2x 195lm	12v DC	Tri-Colour Built-in 2x 3w LED
HV3647T-BLK-240V	3000K - 4000K - 5500K	360lm - 375lm - 390lm	240v	Tri-Colour Built-in 6w LED
HV3647T-BLK-12V	3000K - 4000K - 5500K	360lm - 375lm - 390lm	12v DC	Tri-Colour Built-in 6w LED
HV3648T-BLK-240V	3000K - 4000K - 5500K	2x 300lm - 2x 310lm - 2x 325lm	240v	Tri-Colour Built-in 2x 5w LED
HV3648T-BLK-12V	3000K - 4000K - 5500K	2x 300lm - 2x 310lm - 2x 325lm	12v DC	Tri-Colour Built-in 2x 5w LED

See pages 295-306 for compatible drivers. All low voltage products that specify an input of 12v or 24v DC must be used with a suitable LED driver.



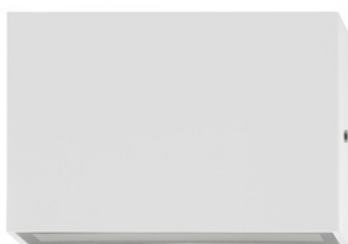

Fixed Down
HV3645T-WHT-240V
HV3645T-WHT-12V

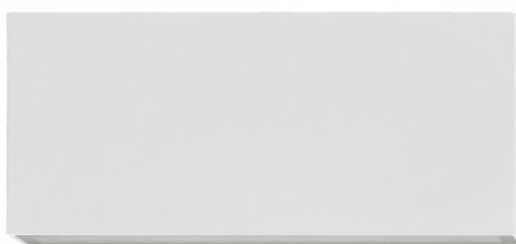
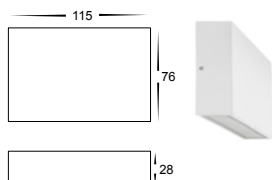

Fixed Down
HV3647T-WHT-240V
HV3647T-WHT-12V

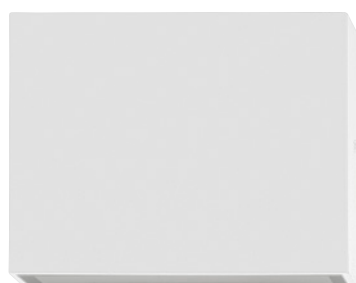
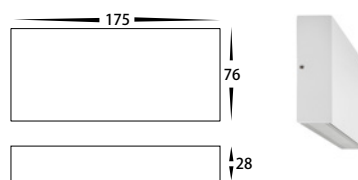

Up & Down
HV3646T-WHT-240V
HV3646T-WHT-12V

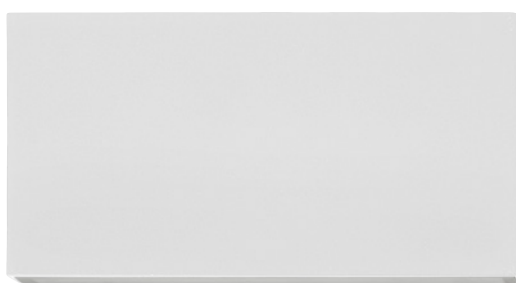
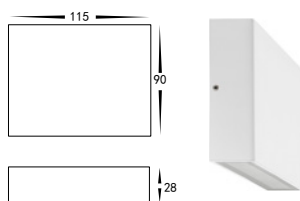

Up & Down
HV3648T-WHT-240V
HV3648T-WHT-12V

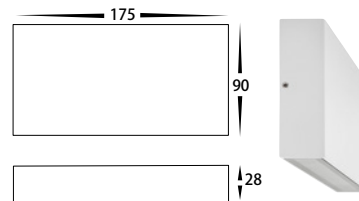

Essil Aluminium White

- Slim wall light Fixed down or up & down lighting
- Aluminium Poly Powder Coated White
- Tempered glass
- IP Rating: IP54

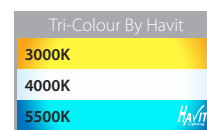

PART NUMBER	COLOUR TEMP	LUMENS	INPUT	INCLUDED LED
HV3645T-WHT-240V	3000K - 4000K - 5500K	240lm - 250lm - 260lm	240v	Tri-Colour Built-in 4w LED
HV3645T-WHT-12V	3000K - 4000K - 5500K	240lm - 250lm - 260lm	12v DC	Tri-Colour Built-in 4w LED
HV3646T-WHT-240V	3000K - 4000K - 5500K	2x 180lm - 2x 187lm - 2x 195lm	240v	Tri-Colour Built-in 2x 3w LED
HV3646T-WHT-12V	3000K - 4000K - 5500K	2x 180lm - 2x 187lm - 2x 195lm	12v DC	Tri-Colour Built-in 2x 3w LED
HV3647T-WHT-240V	3000K - 4000K - 5500K	360lm - 375lm - 390lm	240v	Tri-Colour Built-in 6w LED
HV3647T-WHT-12V	3000K - 4000K - 5500K	360lm - 375lm - 390lm	12v DC	Tri-Colour Built-in 6w LED
HV3648T-WHT-240V	3000K - 4000K - 5500K	2x 300lm - 2x 310lm - 2x 325lm	240v	Tri-Colour Built-in 2x 5w LED
HV3648T-WHT-12V	3000K - 4000K - 5500K	2x 300lm - 2x 310lm - 2x 325lm	12v DC	Tri-Colour Built-in 2x 5w LED

See pages 295-306 for compatible drivers. All low voltage products that specify an input of 12v or 24v DC must be used with a suitable LED driver.



For detailed product specifications
 visit www.Havit.com.au
 or scan this QR code



HV3649T-BLK-240V
HV3649T-BLK-12V
 Aluminium Black

HV3649T-WHT-240V
HV3649T-WHT-12V
 Aluminium White



Essil Aluminium

- Up & Down LED Wall Light
- Aluminium Poly Powder Coated Black and White
- Triac Dimmable (240v Model only)
- IP Rating: IP54

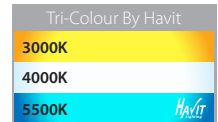

PART NUMBER	COLOUR TEMP	LUMENS	INPUT	INCLUDED LED
HV3649T-BLK-240V	3000K - 4000K - 5500K	2x 350lm - 2x 360lm - 2x 370lm	240v	Tri-Colour 2x 6w Built in LED
HV3649T-BLK-12V	3000K - 4000K - 5500K	2x 350lm - 2x 360lm - 2x 370lm	12v DC	Tri-Colour 2x 6w Built in LED
HV3649T-WHT-240V	3000K - 4000K - 5500K	2x 350lm - 2x 360lm - 2x 370lm	240v	Tri-Colour 2x 6w Built in LED
HV3649T-WHT-12V	3000K - 4000K - 5500K	2x 350lm - 2x 360lm - 2x 370lm	12v DC	Tri-Colour 2x 6w Built in LED

See pages 295-306 for compatible drivers. All low voltage products that specify an input of 12v or 24v DC must be used with a suitable LED driver.



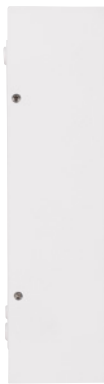
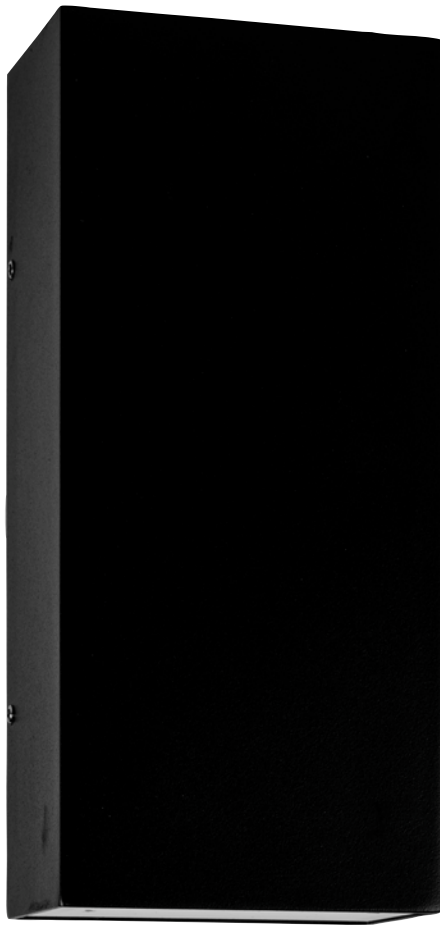

HV3650T-BLK-240V
HV3650T-BLK-12V
 Aluminium Black

HV3650T-WHT-240V
HV3650T-WHT-12V
 Aluminium White

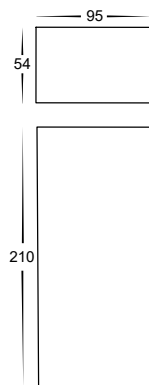

Essil Aluminium

- Up & Down wall light
- Aluminium Poly Powder Coated Black and White
- Triac Dimmable (240v Model only)
- IP Rating: IP54

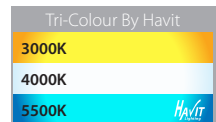

PART NUMBER	COLOUR TEMP	LUMENS	INPUT	INCLUDED LED
HV3650T-BLK-240V	3000K - 4000K - 5500K	2x 350lm - 2x 360lm - 2x 370lm	240v	Tri-Colour 2x 6w Built-in LED
HV3650T-BLK-12V	3000K - 4000K - 5500K	2x 350lm - 2x 360lm - 2x 370lm	12v	Tri-Colour 2x 6w Built-in LED
HV3650T-WHT-240V	3000K - 4000K - 5500K	2x 350lm - 2x 360lm - 2x 370lm	240v	Tri-Colour 2x 6w Built-in LED
HV3650T-WHT-12V	3000K - 4000K - 5500K	2x 350lm - 2x 360lm - 2x 370lm	12v	Tri-Colour 2x 6w Built-in LED

See pages 295-306 for compatible drivers. All low voltage products that specify an input of 12v or 24v DC must be used with a suitable LED driver.



For detailed product specifications
 visit www.Havit.com.au
 or scan this QR code



**Fixed Down
HV3654T-WHT
Aluminium White**



**Fixed Down
HV3654T-BLK
Aluminium Black**

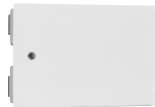
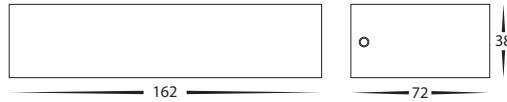

**Up & Down
HV3655T-WHT
Aluminium White**

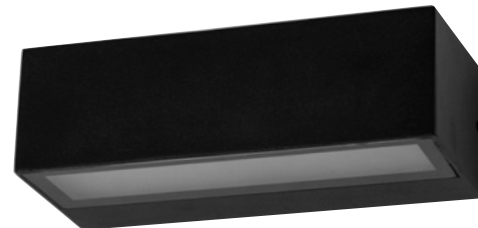

**Up & Down
HV3655T-BLK
Aluminium Black**



Siena Aluminium

- Outdoor Wall Lights
- Fixed down or up & down lighting
- Aluminium Poly Powder Coated Black or White
- Triac Dimmable
- IP Rating: IP54

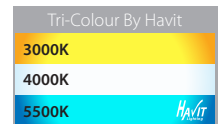

PART NUMBER	COLOUR TEMP	LUMENS	INPUT	INCLUDED LED
HV3654T-BLK	3000K - 4000K - 5500K	230lm - 255lm - 235lm	240v AC	Tri-Colour Built in 6w
HV3654T-WHT	3000K - 4000K - 5500K	230lm - 255lm - 235lm	240v AC	Tri-Colour Built in 6w
HV3655T-BLK	3000K - 4000K - 5500K	2x 255lm - 2x 265lm - 2x 260lm	240v AC	Tri-Colour Built in 2x 4.5w
HV3655T-WHT	3000K - 4000K - 5500K	2x 255lm - 2x 265lm - 2x 260lm	240v AC	Tri-Colour Built in 2x 4.5w

See pages 295-306 for compatible drivers. All low voltage products that specify an input of 12v or 24v DC must be used with a suitable LED driver.





**Fixed Down
HV3656T-WHT
Aluminium White**

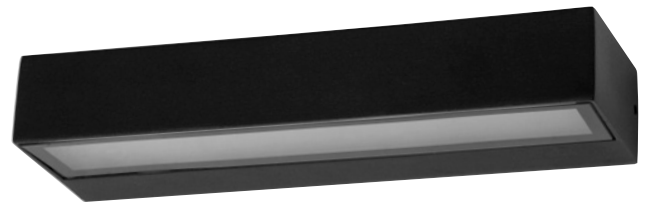
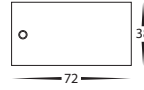
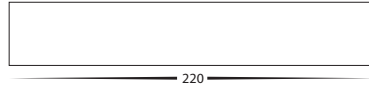

**Fixed Down
HV3656T-BLK
Aluminium Black**



**Up & Down
HV3657T-WHT
Aluminium White**

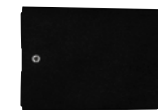
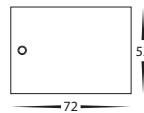
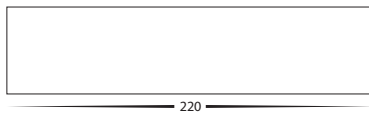

**Up & Down
HV3657T-BLK
Aluminium Black**

Siena Aluminium

- Outdoor Wall Lights
- Fixed down or up & down lighting
- Aluminium Poly Powder Coated Black or White
- Triac Dimmable
- IP Rating: IP54

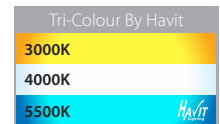

PART NUMBER	COLOUR TEMP	LUMENS	INPUT	INCLUDED LED
HV3656T-BLK	3000K - 4000K - 5500K	435lm - 470lm - 455lm	240v AC	Tri-Colour Built in 9w
HV3656T-WHT	3000K - 4000K - 5500K	435lm - 470lm - 455lm	240v AC	Tri-Colour Built in 9w
HV3657T-BLK	3000K - 4000K - 5500K	2x 345lm - 2x 350lm - 2x 345lm	240v AC	Tri-Colour Built in 2x 6w
HV3657T-WHT	3000K - 4000K - 5500K	2x 345lm - 2x 350lm - 2x 345lm	240v AC	Tri-Colour Built in 2x 6w

See pages 295-306 for compatible drivers. All low voltage products that specify an input of 12v or 24v DC must be used with a suitable LED driver.



For detailed product specifications
visit www.Havit.com.au
or scan this QR code





HV3658T-BLK-RND
HV3658T-BLK-RND-12V
 Aluminium Black



HV3658T-WHT-RND
HV3658T-WHT-RND-12V
 Aluminium White

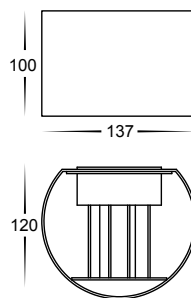

Versa Aluminium

- Up & Down LED Wall Light
- Aluminium Poly Powder Coated Black and White
- Adjustable beam angle
- IP Rating: IP65

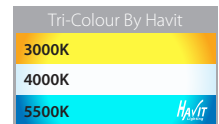

PART NUMBER	COLOUR TEMP	LUMENS	INPUT	INCLUDED LED
HV3658T-BLK-RND	3000K - 4000K - 5500K	2x 220lm - 2x 230lm - 2x 240lm	240V	Tri-Colour Built in 2x 3w LED
HV3658T-BLK-RND-12V	3000K - 4000K - 5500K	2x 220lm - 2x 230lm - 2x 240lm	12v DC	Tri-Colour Built in 2x 3w LED
HV3658T-WHT-RND	3000K - 4000K - 5500K	2x 220lm - 2x 230lm - 2x 240lm	240V	Tri-Colour Built in 2x 3w LED
HV3658T-WHT-RND-12V	3000K - 4000K - 5500K	2x 220lm - 2x 230lm - 2x 240lm	12v DC	Tri-Colour Built in 2x 3w LED

See pages 295-306 for compatible drivers. All low voltage products that specify an input of 12v or 24v DC must be used with a suitable LED driver.



For detailed product specifications
 visit www.Havit.com.au
 or scan this QR code



HV3658T-BLK-SQ
HV3658T-BLK-SQ-12V
 Aluminium Black



HV3658T-WHT-SQ
HV3658T-WHT-SQ-12V
 Aluminium White

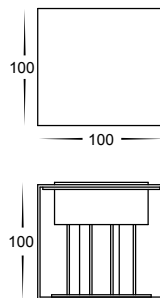

Versa Aluminium

- Up & Down LED Wall Light
- Aluminium Poly Powder Coated Black and White
- Adjustable beam angle
- IP Rating: IP65

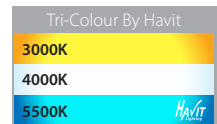

PART NUMBER	COLOUR TEMP	LUMENS	INPUT	INCLUDED LED
HV3658T-BLK-SQ	3000K - 4000K - 5500K	2x 220lm - 2x 230lm - 2x 240lm	240V	Tri-Colour Built in 2x 3w LED
HV3658T-BLK-SQ-12V	3000K - 4000K - 5500K	2x 220lm - 2x 230lm - 2x 240lm	12v DC	Tri-Colour Built in 2x 3w LED
HV3658T-WHT-SQ	3000K - 4000K - 5500K	2x 220lm - 2x 230lm - 2x 240lm	240V	Tri-Colour Built in 2x 3w LED
HV3658T-WHT-SQ-12V	3000K - 4000K - 5500K	2x 220lm - 2x 230lm - 2x 240lm	12v DC	Tri-Colour Built in 2x 3w LED

See pages 295-306 for compatible drivers. All low voltage products that specify an input of 12v or 24v DC must be used with a suitable LED driver.





HV36582T-BLK-SQ
Aluminium Black



HV36582T-WHT-SQ
Aluminium White

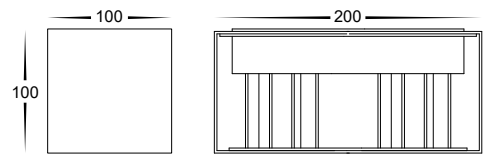
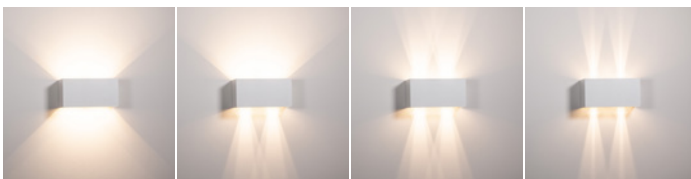

Versa Aluminium

- Outdoor Up & Down Wall Lights
- Aluminium Poly Powder Coated Black or White
- Adjustable Beam Angles
- Triac Dimmable
- IP Rating: IP65

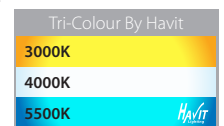

PART NUMBER	COLOUR TEMP	LUMENS	INPUT	INCLUDED LED
HV36582T-BLK-SQ	3000K - 4000K - 5500K	4x 220lm - 4x 230lm - 4x 240lm	240v AC	Tri-Colour Built in 4x 3w
HV36582T-WHT-SQ	3000K - 4000K - 5500K	4x 220lm - 4x 230lm - 4x 240lm	240v AC	Tri-Colour Built in 4x 3w

See pages 295-306 for compatible drivers. All low voltage products that specify an input of 12v or 24v DC must be used with a suitable LED driver.



For detailed product specifications
visit www.Havit.com.au
or scan this QR code

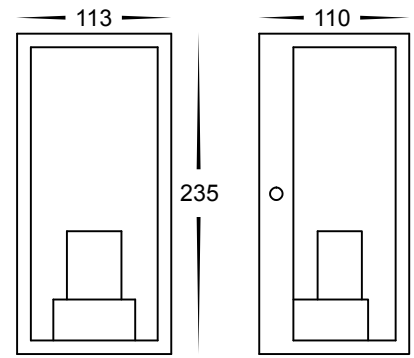

HV3659W-SS316
316 Stainless Steel



HV3659W-BLK
316 Stainless Steel
Poly Powder Coated Black



HV3659W-WHT
316 Stainless Steel
Poly Powder Coated White

Bayside 316 Stainless Steel

- Outdoor Wall Light
- 316 Stainless Steel, 316 Stainless Steel Poly Powder Coated Black or White
- Triac Dimmable
- Supplied with LED Filament Globe
- IP Rating: IP54



PART NUMBER	COLOUR TEMP	LUMENS	INPUT	INCLUDED LED
HV3659W-SS316	2700K	800lm	240v	2x 8w E27 LED Filament Globe
HV3659W-BLK	2700K	800lm	240v	2x 8w E27 LED Filament Globe
HV3659W-WHT	2700K	800lm	240v	2x 8w E27 LED Filament Globe
HAVIT COMPATIBLE ACCESSORIES				
HV9569C	8w E27 5500K LED Filament Globe			
HV9569N	8w E27 4000K LED Filament Globe			



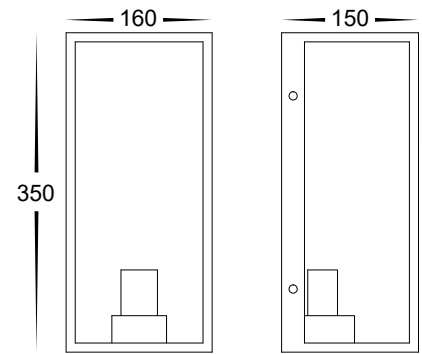

HV3659W-L-SS316
316 Stainless Steel



HV3659W-L-BLK
316 Stainless Steel
Poly Powder Coated Black



HV3659W-L-WHT
316 Stainless Steel
Poly Powder Coated White

Bayside 316 Stainless Steel Large

- Outdoor Wall Lights
- 316 Stainless Steel, 316 Stainless Steel Black or White
- Triac Dimmable
- Supplied with LED Filament Globe
- IP Rating: IP54



PART NUMBER	COLOUR TEMP	LUMENS	INPUT	INCLUDED LED
HV3659W-L-SS316	2700K	400lm	240v AC	2x 4w E27 LED Filament Globe
HV3659W-L-BLK	2700K	400lm	240v AC	2x 4w E27 LED Filament Globe
HV3659W-L-WHT	2700K	400lm	240v AC	2x 4w E27 LED Filament Globe



For detailed product specifications
visit www.Havit.com.au
or scan this QR code



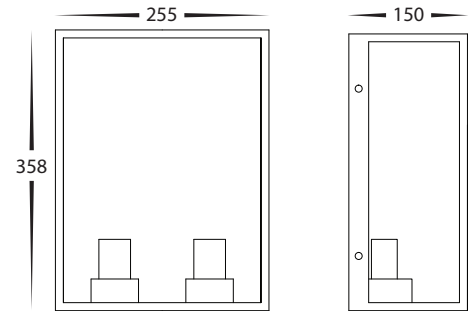

HV36592W-SS316
316 Stainless Steel



HV36592W-BLK
316 Stainless Steel
Poly Powder Coated Black



HV36592W-WHT
316 Stainless Steel
Poly Powder Coated White

Bayside 316 Stainless Steel

- Outdoor Wall Light
- 316 Stainless Steel, 316 Stainless Steel Poly Powder Coated Black or White
- Triac Dimmable
- IP Rating: IP54



PART NUMBER	COLOUR TEMP	LUMENS	INPUT	INCLUDED LED
HV36592W-SS316	2700K	2x400lm	240v	2x 4w E27 LED Filament Globe
HV36592W-BLK	2700K	2x400lm	240v	2x 4w E27 LED Filament Globe
HV36592W-WHT	2700K	2x400lm	240v	2x 4w E27 LED Filament Globe



For detailed product specifications
visit www.Havit.com.au
or scan this QR code



HV3661T-BLK
Aluminium Black



HV3661T-WHT
Aluminium White

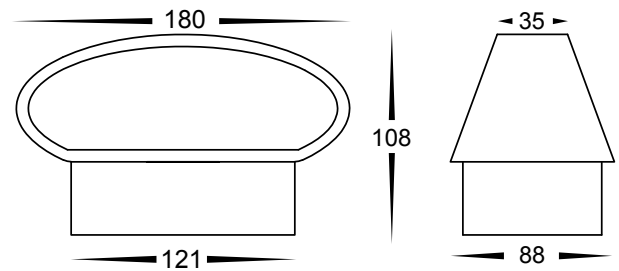

Luxe Aluminium

- LED wall light
- Aluminium Poly Powder Coated Black and White
- IP Rating: IP54

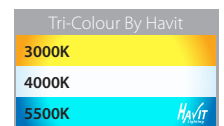

PART NUMBER	COLOUR TEMP	LUMENS	INPUT	INCLUDED LED
HV3661T-BLK	3000K - 4000K - 5500K	400lm - 425lm - 450lm	240V	Tri-Colour Built-in 9w LED
HV3661T-WHT	3000K - 4000K - 5500K	400lm - 425lm - 450lm	240V	Tri-Colour Built-in 9w LED



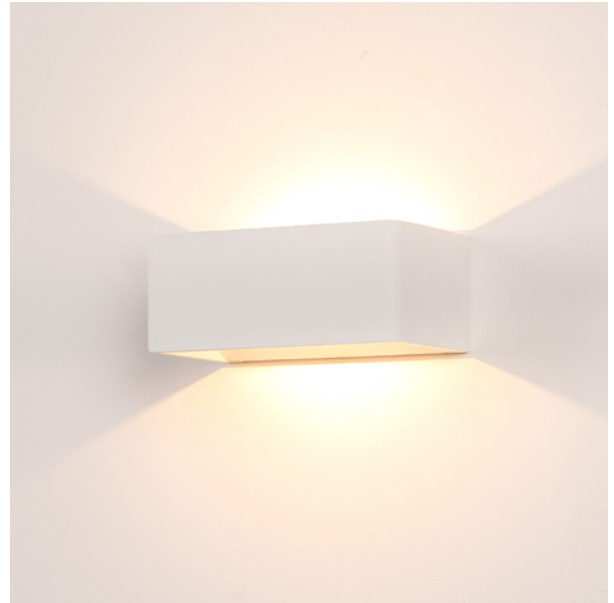

HV3665T-BLK
Aluminium Black



HV3665T-WHT
Aluminium White

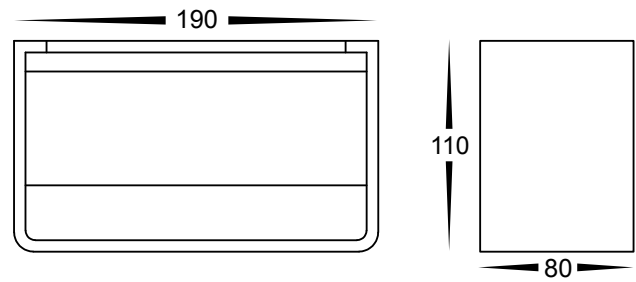

Mia Aluminium

- LED wall light
- Aluminium Poly Powder Coated Black and White
- IP Rating: IP54

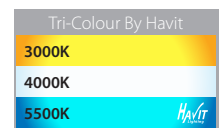

PART NUMBER	COLOUR TEMP	LUMENS	INPUT	INCLUDED LED
HV3665T-BLK	3000K - 4000K - 5500K	400lm - 425lm - 450lm	240V	Tri-Colour Built-in 9w LED
HV3665T-WHT	3000K - 4000K - 5500K	400lm - 425lm - 450lm	240V	Tri-Colour Built-in 9w LED



For detailed product specifications
visit www.Havit.com.au
or scan this QR code



HV3668T-BLK
Aluminium Black



HV3668T-WHT
Aluminium White

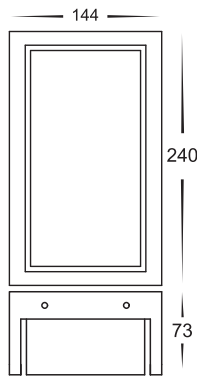

Nepean

- Exterior Wall Light
- Aluminium Poly Powder Coated Black or White
- Polycarbonate Opal Diffuser
- IP Rating: IP54

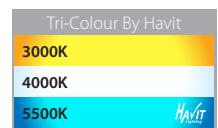

PART NUMBER	COLOUR TEMP	LUMENS	INPUT	INCLUDED LED
HV3668T-BLK	3000K - 4000K - 5500K	1180lm - 1320lm - 1240lm	240V	Tri-Colour Built-in 12w LED
HV3668T-WHT	3000K - 4000K - 5500K	1180lm - 1320lm - 1240lm	240V	Tri-Colour Built-in 12w LED





HV3669T-BLK
Aluminium Black



HV3669T-WHT
Aluminium White

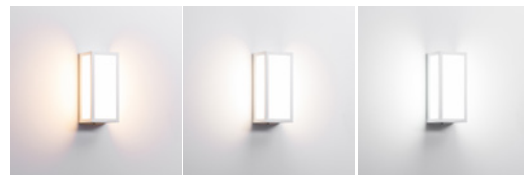
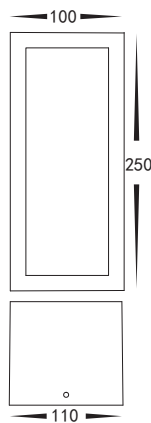

Jasper

- Exterior Wall Light
- Aluminium Poly Powder Coated Black or White
- Polycarbonate Opal Diffuser
- IP Rating: IP54

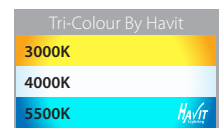

PART NUMBER	COLOUR TEMP	LUMENS	INPUT	INCLUDED LED
HV3669T-BLK	3000K - 4000K - 5500K	1180lm - 1320lm - 1240lm	240V	Tri-Colour Built-in 12w LED
HV3669T-WHT	3000K - 4000K - 5500K	1180lm - 1320lm - 1240lm	240V	Tri-Colour Built-in 12w LED



For detailed product specifications
visit www.Havit.com.au
or scan this QR code



HV3670T-BLK



HV3671T-BLK

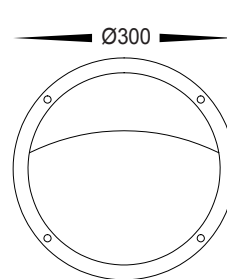
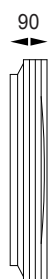
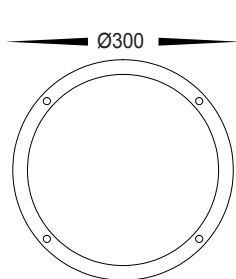

Stor Aluminium Black

- Bunker wall lights
- Aluminium Poly Powder Coated Black
- Polycarbonate Opal Diffuser
- IP Rating: IP54

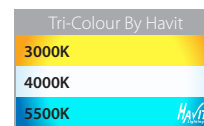

PART NUMBER	COLOUR TEMP	LUMENS	INPUT	INCLUDED LED
HV3670T-BLK	3000K - 4000K - 5500K	2250lm - 2325lm - 2400lm	240V	Tri-Colour Built-in 30w LED
HV3671T-BLK	3000K - 4000K - 5500K	2250lm - 2325lm - 2400lm	240V	Tri-Colour Built-in 30w LED





HV36003T-BLK



HV36012T-BLK

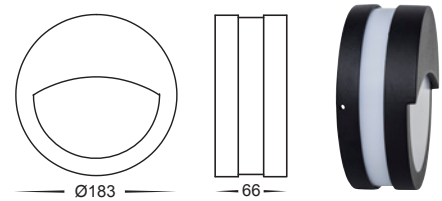
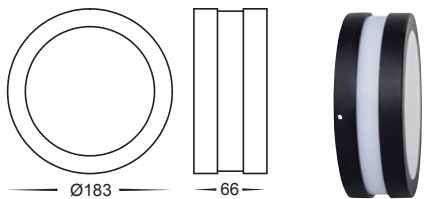

Roto Aluminium Black

- Exterior Wall Light
- Aluminum Poly Powder Coated Black
- Polycarbonate Opal Diffuser
- IP rating: IP54

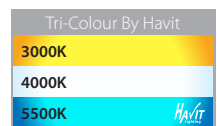

PART NUMBER	COLOUR TEMP	LUMENS	INPUT	INCLUDED LED
HV36003T-BLK	3000K - 4000K - 5500K	520lm - 600lm - 570lm	240V	Tri-Colour Built-in 10w LED
HV36012T-BLK	3000K - 4000K - 5500K	520lm - 600lm - 570lm	240V	Tri-Colour Built-in 10w LED



For detailed product specifications
visit www.Havit.com.au
or scan this QR code



HV3672W-BLK

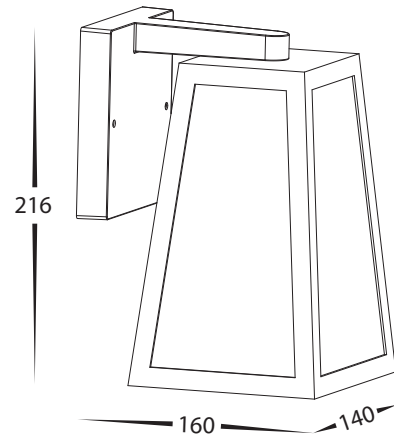

Licht Aluminium Black

- Coach Light
- Clear glass
- Aluminium Powder Coated Black
- IP Rating: IP44



PART NUMBER	COLOUR TEMP	LUMENS	INPUT	INCLUDED LED
HV3672W-BLK	2700k	700lm	240v	9w E27 LED Filament Globe





HV3673W-BLK

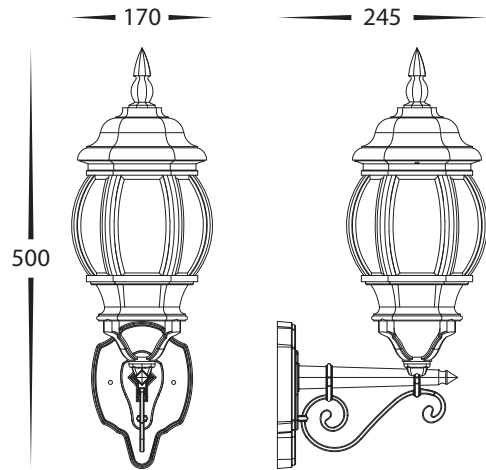

Trener Aluminium Black

- Coach Light
- Clear glass
- Aluminium Powder Coated Black
- IP Rating: IP44



PART NUMBER	COLOUR TEMP	LUMENS	INPUT	INCLUDED LED
HV3673W-BLK	2700k	700lm	240v	9w E27 LED Filament Globe



For detailed product specifications
visit www.Havit.com.au
or scan this QR code

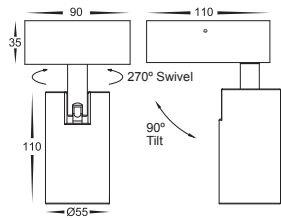

Single Adjustable
HV3681T-BLK

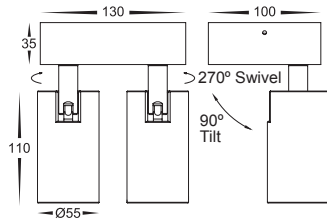

Double Adjustable
HV3683T-BLK

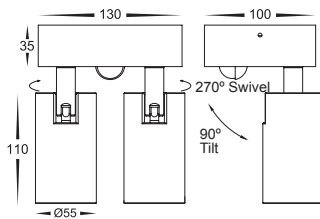

Sensor Double Adjustable
HV3684T-BLK

Revo Aluminium Black

- Single & Double Adjustable wall light
- Aluminium poly powder coated black
- Tempered glass
- IP Rating: IP65

Revo Sensor Aluminium Black

- Double Adjustable wall light
- Aluminium poly powder coated black
- 120° Sensor detection
- Lux and time settings on sensor
- Up to 10 metre detection range
- Manual override function
- Tempered glass
- IP Rating: IP65

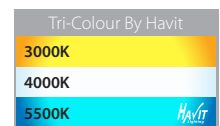

PART NUMBER	COLOUR TEMP	LUMENS	INPUT	INCLUDED LED
HV3681T-BLK	3000K - 4000K - 5500K	810lm - 850lm - 900lm	240v	Tri-Colour Built-in 9w LED
HV3683T-BLK	3000K - 4000K - 5500K	2x 810lm - 2x 850lm - 2x 900lm	240v	Tri-Colour Built-in 2x 9w
HV3684T-BLK	3000K - 4000K - 5500K	2x 810lm - 2x 850lm - 2x 900lm	240v	Tri-Colour Built-in 2x 9w



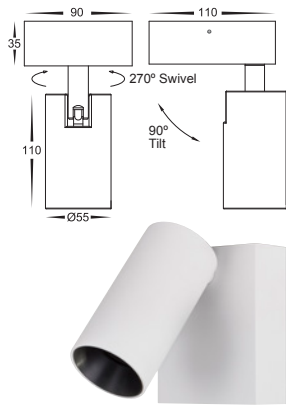

**Single Adjustable
HV3681T-WHT**

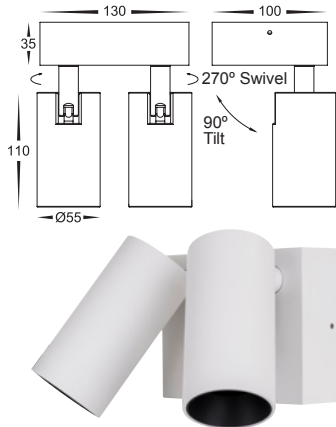

**Double Adjustable
HV3683T-WHT**

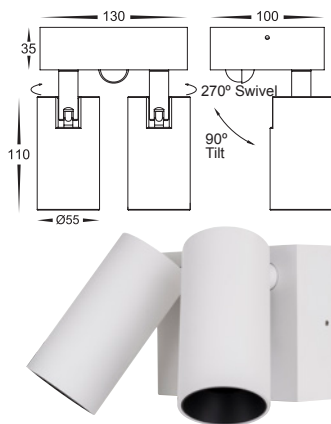

**Sensor Double Adjustable
HV3684T-WHT**

Revo Aluminium White

- Single & Double Adjustable wall light
- Aluminium poly powder coated white
- Tempered glass
- IP Rating: IP65

Revo Sensor Aluminium White

- Double Adjustable wall light
- Aluminium poly powder coated white
- 120° Sensor detection
- Lux and time settings on sensor
- Up to 10 metre detection range
- Manual override function
- Tempered glass
- IP Rating: IP65

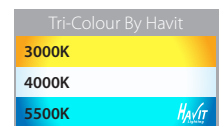

PART NUMBER	COLOUR TEMP	LUMENS	INPUT	INCLUDED LED
HV3681T-WHT	3000K - 4000K - 5500K	810lm - 850lm - 900lm	240v	Tri-Colour Built-in 9w LED
HV3683T-WHT	3000K - 4000K - 5500K	2x 810lm - 2x 850lm - 2x 900lm	240v	Tri-Colour Built-in 2x 9w
HV3684T-WHT	3000K - 4000K - 5500K	2x 810lm - 2x 850lm - 2x 900lm	240v	Tri-Colour Built-in 2x 9w



For detailed product specifications
visit www.Havit.com.au
or scan this QR code



HV3686T-BLK



HV3686T-WHT

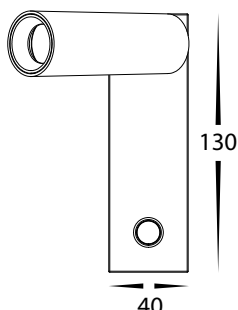
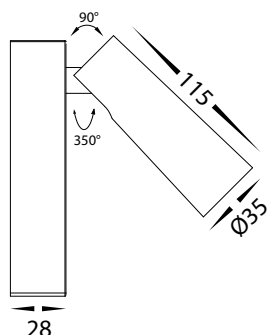

Lesen Aluminium

- Reading Wall Light
- Aluminium Powder Coated Black or White
- Touch Dimming
- IP Rating: IP20

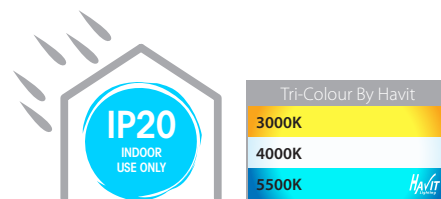

PART NUMBER	COLOUR TEMP	LUMENS	INPUT	INCLUDED LED
HV3686T-BLK	3000K - 4000K - 5500K	135lm - 160lm - 150lm	240v AC	Tri Colour 2.5w Built in LED
HV3686T-WHT	3000K - 4000K - 5500K	135lm - 160lm - 150lm	240v AC	Tri Colour 2.5w Built in LED





HV3687T-BLK



HV3687T-WHT

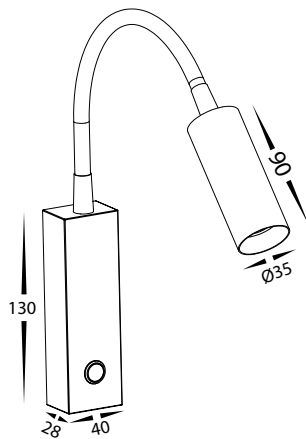

Lesen Aluminium

- Reading Wall Light with Flexible Arm
- Aluminium Powder Coated Black or White
- Touch Dimming
- IP Rating: IP20

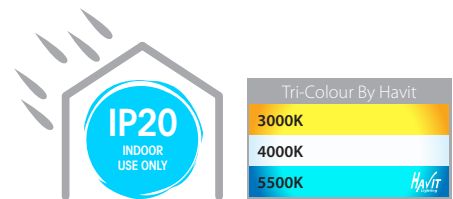

PART NUMBER	COLOUR TEMP	LUMENS	INPUT	INCLUDED LED
HV3687T-BLK	3000K - 4000K - 5500K	135lm - 160lm - 150lm	240v AC	Tri Colour 2.5w Built in LED
HV3687T-WHT	3000K - 4000K - 5500K	135lm - 160lm - 150lm	240v AC	Tri Colour 2.5w Built in LED



For detailed product specifications
visit www.Havit.com.au
or scan this QR code



HV3688T-BLK
Aluminium Black



HV3688T-WHT
Aluminium White

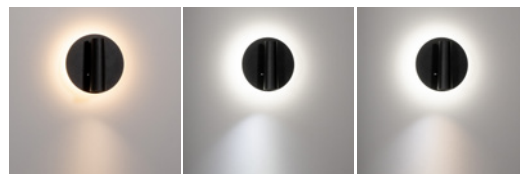
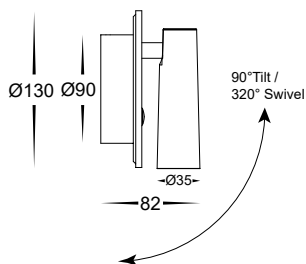

Lesen Aluminium

- Single Adjustable Wall Light
- Aluminium Powder Coated Black or White
- Backlight LED
- Touch Dimming
- IP Rating: IP20

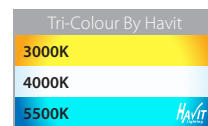

PART NUMBER	COLOUR TEMP	LUMENS	INPUT	INCLUDED LED
HV3688T-BLK	3000K - 4000K - 5500K	2x 124lm - 2x 144lm - 2x 134lm	240v AC	Tri-Colour Built in 2x 3w
HV3688T-WHT	3000K - 4000K - 5500K	2x 124lm - 2x 144lm - 2x 134lm	240v AC	Tri-Colour Built in 2x 3w





HV3689T-AB
Antique Brass



HV3689T-BLK
Aluminium Black



HV3689T-BLKBR
Brass on Black base



HV3689T-WHT
Aluminium White

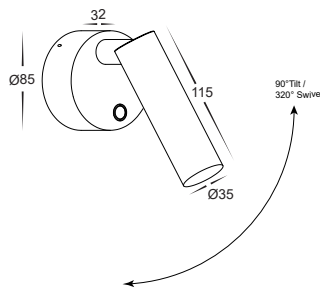

Lesen Aluminium

- Single adjustable wall light
- Antique Brass, Aluminium Powder Coated Black, Brass on Black base, Aluminium Powder Coated White
- Touch Dimming
- IP Rating: IP20



PART NUMBER	COLOUR TEMP	LUMENS	INPUT	INCLUDED LED
HV3689T-AB	3000K - 4000K - 5500K	85lm - 110lm - 105lm	240v	Tri-Colour 5w Built in LED
HV3689T-BLK	3000K - 4000K - 5500K	85lm - 110lm - 105lm	240v	Tri-Colour 5w Built in LED
HV3689T-BLKBR	3000K - 4000K - 5500K	85lm - 110lm - 105lm	240v	Tri-Colour 5w Built in LED
HV3689T-WHT	3000K - 4000K - 5500K	85lm - 110lm - 105lm	240v	Tri-Colour 5w Built in LED



For detailed product specifications
visit www.Havit.com.au
or scan this QR code



HV3691T-BLK-240V



HV3691T-WHT-240V

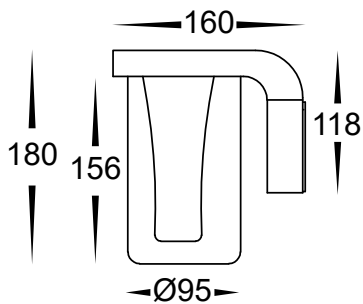

Otaner Aluminium

- LED Wall Light
- Aluminium Poly Powder Coated Black or White
- Clear glass
- IP Rating: IP54
- IK Rating: IK04

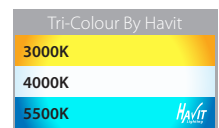

PART NUMBER	COLOUR TEMP	LUMENS	INPUT	INCLUDED LED
HV3691T-BLK-240V	3000K - 4000K - 5500K	695lm - 730lm - 710lm	240v AC	Tri Colour 10w Built in LED
HV3691T-WHT-240V	3000K - 4000K - 5500K	695lm - 730lm - 710lm	240v AC	Tri Colour 10w Built in LED





HV3692W-BLK



HV3692W-WHT

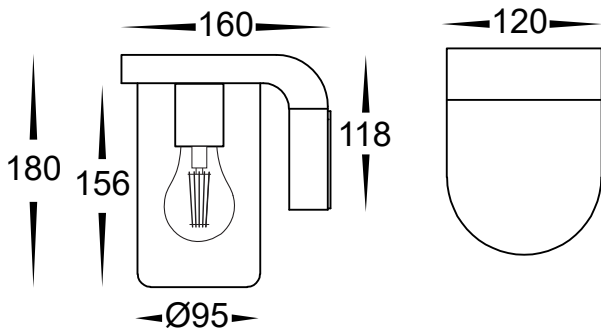
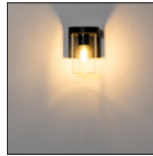

Angela Aluminium

- LED Wall Light
- Aluminium Poly Powder Coated Black or White
- Clear glass
- Dimmable
- IP Rating: IP54
- IK Rating: IK04



PART NUMBER	COLOUR TEMP	LUMENS	INPUT	INCLUDED LED
HV3692W-BLK	2700k	700lm	240V	9w E27 LED Filament Globe
HV3692W-WHT	2700k	700lm	240V	9w E27 LED Filament Globe



For detailed product specifications
visit www.Havit.com.au
or scan this QR code





HV3693T-BLK-240V

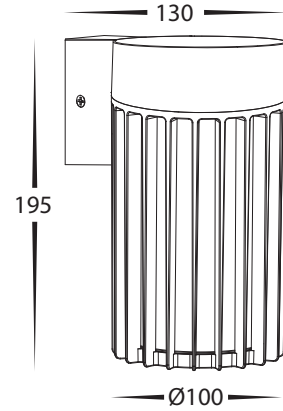

Tenac Aluminium Black

- LED Wall Light
- Aluminium Poly Powder Coated Black
- IP Rating: IP54
- IK Rating: IK08

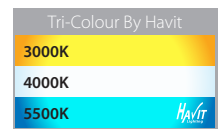

PART NUMBER	COLOUR TEMP	LUMENS	INPUT	INCLUDED LED
HV3693T-BLK-240V	3000K - 4000K - 5500K	700lm - 740lm - 720lm	240V	Tri Colour 9w E27 LED



HV3694W-BLK

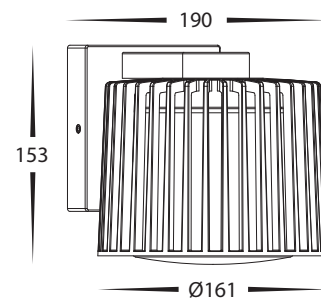

Lumo Aluminium

- LED Wall Light
- Aluminium Poly Powder Coated Black
- Dimmable
- IP Rating: IP54
- IK Rating: IK04



PART NUMBER	COLOUR TEMP	LUMENS	INPUT	INCLUDED LED
HV3694W-BLK	2700k	700lm	240V	9w E27 LED Filament Globe



For detailed product specifications visit www.Havit.com.au or scan this QR code

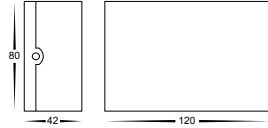

HV3695T-BLK-240V
HV3695T-BLK-12V

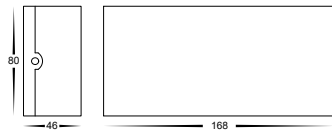

HV3696T-BLK-240V
HV3696T-BLK-12V

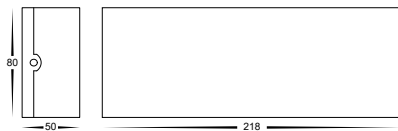

HV3697T-BLK-240V
HV3697T-BLK-12V

Maro Aluminium Black

- Multiple Light Up & Down Wall Light
- Aluminium Poly Powder Coated Black
- IP Rating: IP54

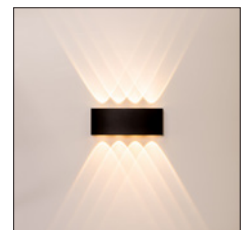
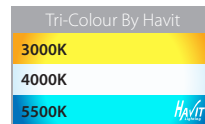

PART NUMBER	COLOUR TEMP	LUMENS	INPUT	INCLUDED LED
HV3695T-BLK-240V	3000K - 4000K - 5500K	2x 85lm - 2x 90lm - 2x 90lm	240v	Tri-Colour 4x 1w Built in LED
HV3695T-BLK-12V	3000K - 4000K - 5500K	2x 85lm - 2x 90lm - 2x 90lm	12v DC	Tri-Colour 4x 1w Built in LED
HV3696T-BLK-240V	3000K - 4000K - 5500K	2x 145lm - 2x 148lm - 2x 147lm	240v	Tri-Colour 6x 1w Built in LED
HV3696T-BLK-12V	3000K - 4000K - 5500K	2x 145lm - 2x 148lm - 2x 147lm	12v DC	Tri-Colour 6x 1w Built in LED
HV3697T-BLK-240V	3000K - 4000K - 5500K	2x 220lm - 2x 223lm - 2x 222lm	240v	Tri-Colour 8x 1w Built in LED
HV3697T-BLK-12V	3000K - 4000K - 5500K	2x 220lm - 2x 223lm - 2x 222lm	12v DC	Tri-Colour 8x 1w Built in LED

See pages 295-306 for compatible drivers. All low voltage products that specify an input of 12v or 24v DC must be used with a suitable LED driver.



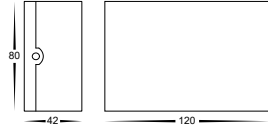

HV3695T-WHT-240V
HV3695T-WHT-12V

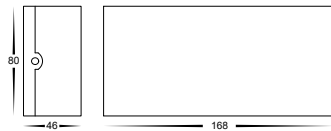

HV3696T-WHT-240V
HV3696T-WHT-12V

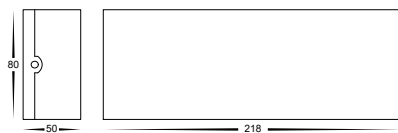

HV3697T-WHT-240V
HV3697T-WHT-12V

Maro Aluminium White

- Multiple Light Up & Down Wall Light
- Aluminium Poly Powder Coated White
- IP Rating: IP54

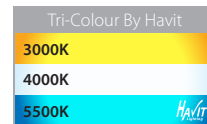

PART NUMBER	COLOUR TEMP	LUMENS	INPUT	INCLUDED LED
HV3695T-WHT-240V	3000K - 4000K - 5500K	2x 85lm - 2x 90lm - 2x 90lm	240v	Tri-Colour 4x 1w Built in LED
HV3695T-WHT-12V	3000K - 4000K - 5500K	2x 85lm - 2x 90lm - 2x 90lm	12v DC	Tri-Colour 4x 1w Built in LED
HV3696T-WHT-240V	3000K - 4000K - 5500K	2x 145lm - 2x 148lm - 2x 147lm	240v	Tri-Colour 6x 1w Built in LED
HV3696T-WHT-12V	3000K - 4000K - 5500K	2x 145lm - 2x 148lm - 2x 147lm	12v DC	Tri-Colour 6x 1w Built in LED
HV3697T-WHT-240V	3000K - 4000K - 5500K	2x 220lm - 2x 223lm - 2x 222lm	240v	Tri-Colour 8x 1w Built in LED
HV3697T-WHT-12V	3000K - 4000K - 5500K	2x 220lm - 2x 223lm - 2x 222lm	12v DC	Tri-Colour 8x 1w Built in LED

See pages 295-306 for compatible drivers. All low voltage products that specify an input of 12v or 24v DC must be used with a suitable LED driver.



For detailed product specifications
visit www.Havit.com.au
or scan this QR code



HV3791T-BLK



HV3793T-BLK



HV3792T-BLK
(with sensor)



HV3794T-BLK
(with sensor)

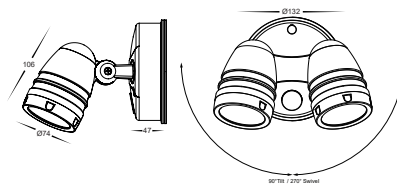
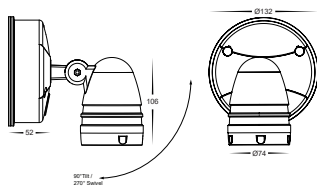

Focus Black

- Single & Double Adjustable Spotlight
- Polycarbonate Black
- IP Rating: IP65

Focus Sensor Black

- Single & Double Adjustable Spotlight with Microwave Sensor
- Polycarbonate Black
- Supplied with Remote to adjust settings
- Ability to adjust Lux & Time settings
- Up to 10 metre sensor range
- Manual Override function
- IP Rating: IP65

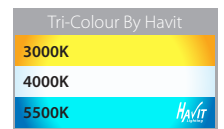

PART NUMBER	COLOUR TEMP	LUMENS	INPUT	INCLUDED LED
HV3791T-BLK	3000K - 4000K - 5500K	1200lm - 1275lm - 1350lm	240v	Tri-Colour 15w Built in LED
HV3792T-BLK	3000K - 4000K - 5500K	1200lm - 1275lm - 1350lm	240v	Tri-Colour 15w Built in LED
HV3793T-BLK	3000K - 4000K - 5500K	2x 1200lm - 2x 1275lm - 2x 1350lm	240v	Tri-Colour 2x15w Built in LED
HV3794T-BLK	3000K - 4000K - 5500K	2x 1200lm - 2x 1275lm - 2x 1350lm	240v	Tri-Colour 2x15w Built in LED





HV3791T-WHT



HV3793T-WHT



**HV3792T-WHT
(with sensor)**



**HV3794T-WHT
(with sensor)**

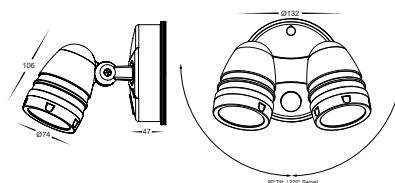
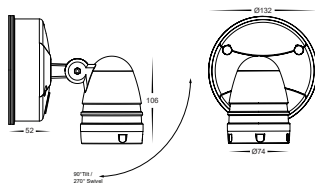

Focus White

- Single & Double Adjustable Spotlight
- Polycarbonate White
- IP Rating: IP65

Focus Sensor White

- Single & Double Adjustable Spotlight with Microwave Sensor
- Polycarbonate White
- Supplied with Remote to adjust settings
- Ability to adjust Lux & Time settings
- Up to 10 metre sensor range
- Manual Override function
- IP Rating: IP65

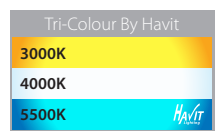

PART NUMBER	COLOUR TEMP	LUMENS	INPUT	INCLUDED LED
HV3791T-WHT	3000K - 4000K - 5500K	1200lm - 1275lm - 1350lm	240v	Tri-Colour 15w Built in LED
HV3792T-WHT	3000K - 4000K - 5500K	1200lm - 1275lm - 1350lm	240v	Tri-Colour 15w Built in LED
HV3793T-WHT	3000K - 4000K - 5500K	2x 1200lm - 2x 1275lm - 2x 1350lm	240v	Tri-Colour 2x15w Built in LED
HV3794T-WHT	3000K - 4000K - 5500K	2x 1200lm - 2x 1275lm - 2x 1350lm	240v	Tri-Colour 2x15w Built in LED



For detailed product specifications
visit www.Havit.com.au
or scan this QR code



2 light bar
HV4001T-2-BLK



3 light bar
HV4001T-3-BLK



4 light bar
HV4001T-4-BLK



3 light round plate
HV4001T-3-BLK-RND



4 light square plate
HV4001T-4-BLK-SQ

Tivah Aluminium Black

- Adjustable spotlights
- Aluminium Poly Powder Coated Black
- 90° tilt & 270° swivel
- High output reflector to maximise light
- IP Rating: IP54

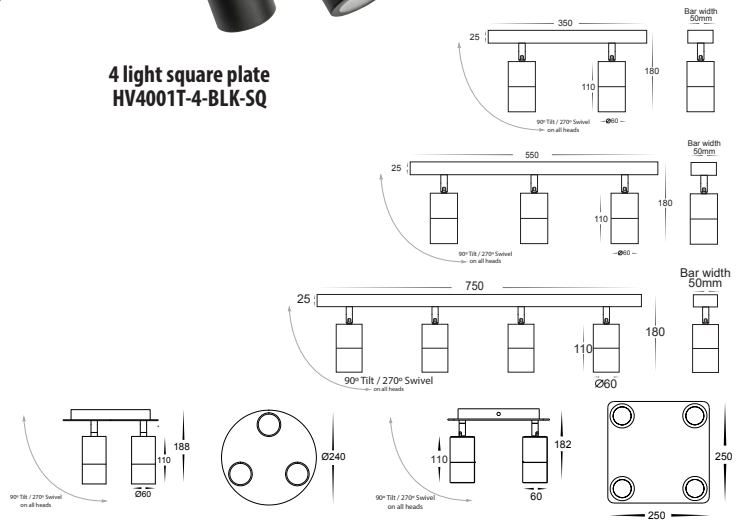
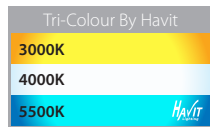

PART NUMBER	COLOUR TEMP	LUMENS	INPUT	INCLUDED LED
HV4001T-2-BLK	3000K - 4000K - 5500K	2x 270lm - 2x 285lm - 2x 300lm	240v	Tri-Colour 2x 5w GU10 LED
HV4001T-3-BLK	3000K - 4000K - 5500K	3x 270lm - 3x 285lm - 3x 300lm	240v	Tri-Colour 3x 5w GU10 LED
HV4001T-4-BLK	3000K - 4000K - 5500K	4x 270lm - 4x 285lm - 4x 300lm	240v	Tri-Colour 4x 5w GU10 LED
HV4001T-3-BLK-RND	3000K - 4000K - 5500K	3x 270lm - 3x 285lm - 3x 300lm	240v	Tri-Colour 3x 5w GU10 LED
HV4001T-4-BLK-SQ	3000K - 4000K - 5500K	4x 270lm - 4x 285lm - 4x 300lm	240v	Tri-Colour 4x 5w GU10 LED
HAVIT COMPATIBLE ACCESSORIES				
HV9506D	3000K - 4000K - 5500K	240lm - 630lm	240v	Tri-Colour 3W/5W/7W





2 light bar
HV4001T-2-WHT



3 light bar
HV4001T-3-WHT



4 light bar
HV4001T-4-WHT



3 light round plate
HV4001T-3-WHT-RND



4 light square plate
HV4001T-4-WHT-SQ

Tivah Aluminium White

- Adjustable spotlights
- Aluminium Poly Powder Coated White
- 90° tilt & 270° swivel
- High output reflector to maximise light
- IP Rating: IP54

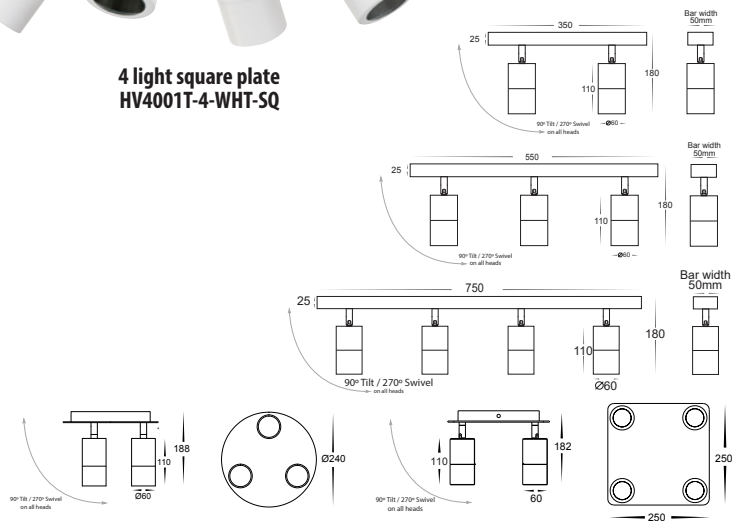
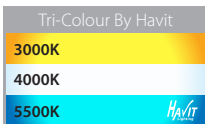

PART NUMBER	COLOUR TEMP	LUMENS	INPUT	INCLUDED LED
HV4001T-2-WHT	3000K - 4000K - 5500K	2x 270lm - 2x 285lm - 2x 300lm	240v	Tri-Colour 2x 5w GU10 LED
HV4001T-3-WHT	3000K - 4000K - 5500K	3x 270lm - 3x 285lm - 3x 300lm	240v	Tri-Colour 3x 5w GU10 LED
HV4001T-4-WHT	3000K - 4000K - 5500K	4x 270lm - 4x 285lm - 4x 300lm	240v	Tri-Colour 4x 5w GU10 LED
HV4001T-3-WHT-RND	3000K - 4000K - 5500K	3x 270lm - 3x 285lm - 3x 300lm	240v	Tri-Colour 3x 5w GU10 LED
HV4001T-4-WHT-SQ	3000K - 4000K - 5500K	4x 270lm - 4x 285lm - 4x 300lm	240v	Tri-Colour 4x 5w GU10 LED
HAVIT COMPATIBLE ACCESSORIES				
HV9506D	3000K - 4000K - 5500K	240lm - 630lm	240v	Tri-Colour 3W/5W/7W



For detailed product specifications
visit www.Havit.com.au
or scan this QR code





Tivah Titanium Aluminum

- Adjustable spotlights
- Titanium Coloured Aluminium
- 90° tilt & 270° swivel
- High output reflector to maximise light
- IP Rating: IP54

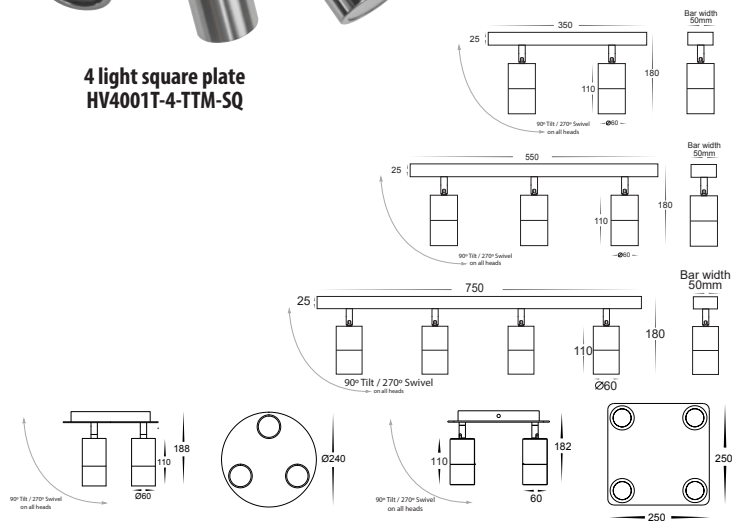
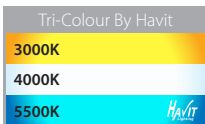

PART NUMBER	COLOUR TEMP	LUMENS	INPUT	INCLUDED LED
HV4001T-2-TTM	3000K - 4000K - 5500K	2x 270lm - 2x 285lm - 2x 300lm	240v	Tri-Colour 2x 5w GU10 LED
HV4001T-3-TTM	3000K - 4000K - 5500K	3x 270lm - 3x 285lm - 3x 300lm	240v	Tri-Colour 3x 5w GU10 LED
HV4001T-3-TTM-RND	3000K - 4000K - 5500K	3x 270lm - 3x 285lm - 3x 300lm	240v	Tri-Colour 3x 5w GU10 LED
HV4001T-4-TTM	3000K - 4000K - 5500K	4x 270lm - 4x 285lm - 4x 300lm	240v	Tri-Colour 4x 5w GU10 LED
HV4001T-4-TTM-SQ	3000K - 4000K - 5500K	4x 270lm - 4x 285lm - 4x 300lm	240v	Tri-Colour 4x 5w GU10 LED
HAVIT COMPATIBLE ACCESSORIES				
HV9506D	3000K - 4000K - 5500K	240lm - 630lm	240v	Tri-Colour 3W/5W/7W



For detailed product specifications
visit www.Havit.com.au
or scan this QR code



1 light round plate
HV4002T-1-BLK



2 light bar
HV4002T-2-BLK



3 light bar
HV4002T-3-BLK



4 light bar
HV4002T-4-BLK



3 light round plate
HV4002T-3-BLK-RND

Revo Aluminum Black

- Adjustable spotlights
- Aluminium Poly Powder Coated Black
- Triac Dimmable
- 45° Beam Angle
- IP20

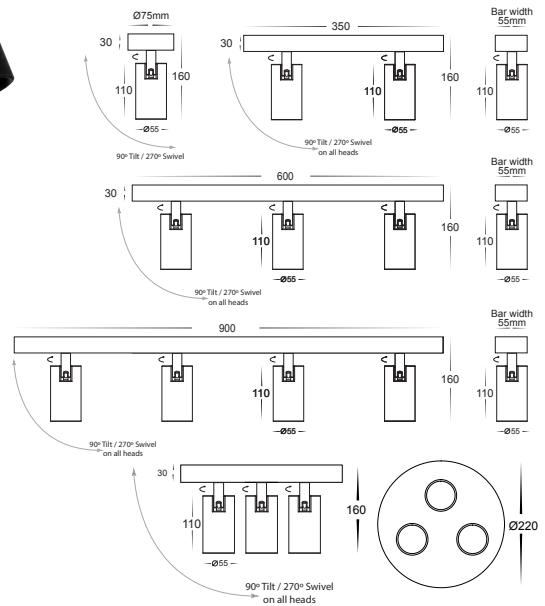
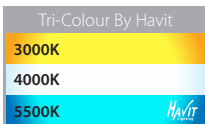

PART NUMBER	COLOUR TEMP	LUMENS	INPUT	INCLUDED LED
HV4002T-1-BLK	3000K - 4000K - 5500K	640lm- 680lm- 720lm	240v	Tri-Colour Built in 8w LED
HV4002T-2-BLK	3000K - 4000K - 5500K	2x 640lm- 2x 680lm- 2x 720lm	240v	Tri-Colour Built in 2x 8w LED
HV4002T-3-BLK	3000K - 4000K - 5500K	3x 640lm- 3x 680lm- 3x 720lm	240v	Tri-Colour Built in 3x 8w LED
HV4002T-3-BLK-RND	3000K - 4000K - 5500K	3x 640lm- 3x 680lm- 3x 720lm	240v	Tri-Colour Built in 3x 8w LED
HV4002T-4-BLK	3000K - 4000K - 5500K	4x 640lm- 4x 680lm- 4x 720lm	240v	Tri-Colour Built in 4x 8w LED





**1 light round plate
HV4002T-1-WHT**



**2 light bar
HV4002T-2-WHT**



**3 light bar
HV4002T-3-WHT**



**4 light bar
HV4002T-4-WHT**



**3 light round plate
HV4002T-3-WHT-RND**

Revo Aluminum White

- Adjustable spotlights
- Aluminium Poly Powder Coated White
- Triac Dimmable
- 45° Beam Angle
- IP20

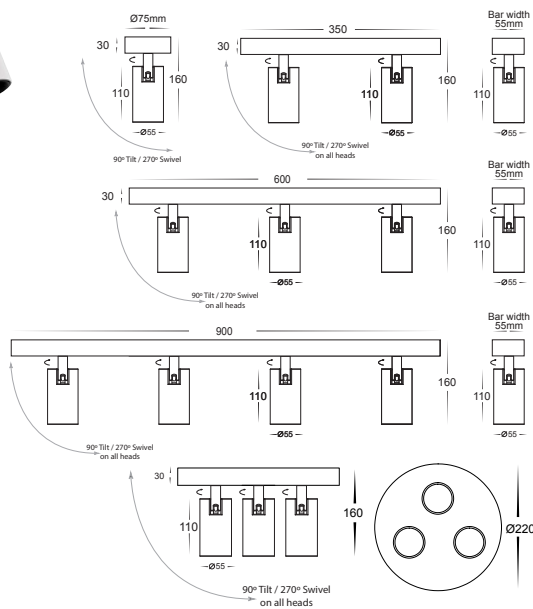
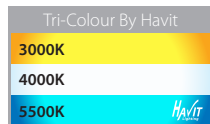

PART NUMBER	COLOUR TEMP	LUMENS	INPUT	INCLUDED LED
HV4002T-1-WHT	3000K - 4000K - 5500K	640lm- 680lm- 720lm	240v	Tri-Colour Built in 8w LED
HV4002T-2-WHT	3000K - 4000K - 5500K	2x 640lm- 2x 680lm- 2x 720lm	240v	Tri-Colour Built in 2x 8w LED
HV4002T-3-WHT	3000K - 4000K - 5500K	3x 640lm- 3x 680lm- 3x 720lm	240v	Tri-Colour Built in 3x 8w LED
HV4002T-3-WHT-RND	3000K - 4000K - 5500K	3x 640lm- 3x 680lm- 3x 720lm	240v	Tri-Colour Built in 3x 8w LED
HV4002T-4-WHT	3000K - 4000K - 5500K	4x 640lm- 4x 680lm- 4x 720lm	240v	Tri-Colour Built in 4x 8w LED



For detailed product specifications
visit www.Havit.com.au
or scan this QR code

HV5511CCT-BLK
HV5511RGBCW-BLK

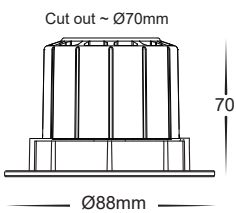

HV5512CCT-BLK
HV5512RGBCW-BLK

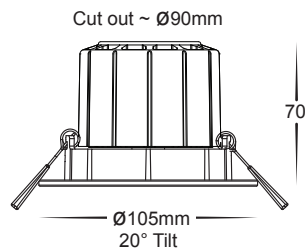

HV5513CCT-BLK
HV5513RGBCW-BLK

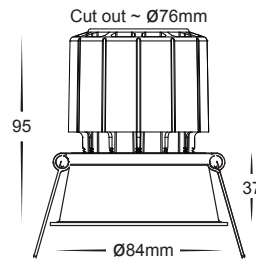

HV5514CCT-BLK
HV5514RGBCW-BLK

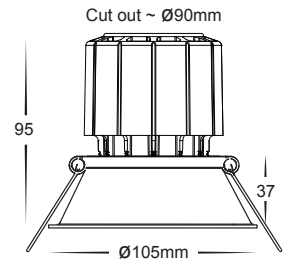

Prime HaviSMART Aluminium Black

- Wifi LED Downlights
- Aluminium Black
- Aluminium Heat Sink
- Supplied with dimmable driver complete with flex & plug
- 120° beam angle
- CRI>90
- IC-4 Rated (fitting only)
- IP Rating: IP54 (front only)

works with alexa
works with Hey Google
Powered by tuya Intelligence Inside
Compatible with major smart home systems.

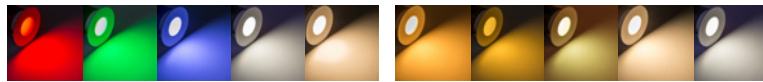

IC-4
Smart CCT By Havit
2700K 6500K
Havit



PART NUMBER	CUT OUT	COLOUR TEMP	LUMENS	INPUT	INCLUDED LED
HV5511CCT-BLK	70mm	2700K-6500K	330lm-340lm	240v	CCT Built-in 12w LED
HV5511RGBCW-BLK	70mm	RGBCW	300lm-320lm	240v	RGBCW Built-in 12w LED
HV5512CCT-BLK	90mm	2700K-6500K	330lm-340lm	240v	CCT Built-in 12w LED
HV5512RGBCW-BLK	90mm	RGBCW	300lm-320lm	240v	RGBCW Built-in 12w LED
HV5513CCT-BLK	76mm	2700K-6500K	330lm-340lm	240v	CCT Built-in 12w LED
HV5513RGBCW-BLK	76mm	RGBCW	300lm-320lm	240v	RGBCW Built-in 12w LED
HV5514CCT-BLK	90mm	2700K-6500K	330lm-340lm	240v	CCT Built-in 12w LED
HV5514RGBCW-BLK	90mm	RGBCW	300lm-320lm	240v	RGBCW Built-in 12w LED



HV5511T-BLK

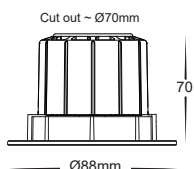

HV5512T-BLK

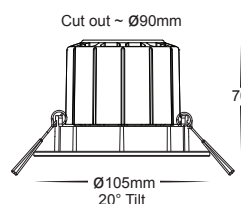

HV5513T-BLK

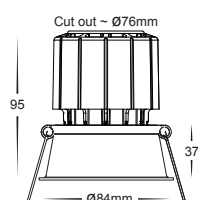

HV5514T-BLK

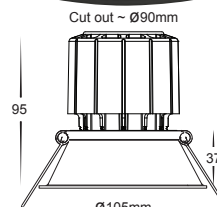

Prime Aluminium Black

- Dimmable LED downlights
- Aluminium Black
- Aluminium Heat Sink
- Supplied with dimmable driver complete with flex & plug
- 60° beam angle
- CRI > 90
- IC-4 Rated (fitting only)
- IP Rating: IP54 (front only)

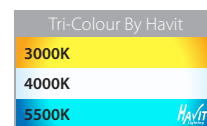

PART NUMBER	CUT OUT	COLOUR TEMP	LUMENS	INPUT	INCLUDED LED
HV5511T-BLK	70mm	3000K - 4000K - 5500K	839lm - 913lm - 841lm	240v	Tri-Colour Built-in 12w LED
HV5512T-BLK	90mm	3000K - 4000K - 5500K	839lm - 913lm - 841lm	240v	Tri-Colour Built-in 12w LED
HV5513T-BLK	76mm	3000K - 4000K - 5500K	839lm - 913lm - 841lm	240v	Tri-Colour Built-in 12w LED
HV5514T-BLK	90mm	3000K - 4000K - 5500K	839lm - 913lm - 841lm	240v	Tri-Colour Built-in 12w LED



For detailed product specifications
visit www.Havit.com.au
or scan this QR code

HV5511CCT-WHT
HV5511RGBCW-WHT



HV5512CCT-WHT
HV5512RGBCW-WHT



HV5513CCT-WHT
HV5513RGBCW-WHT



HV5514CCT-WHT
HV5514RGBCW-WHT

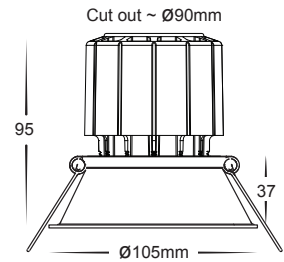
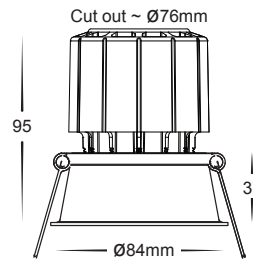
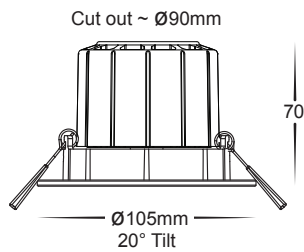
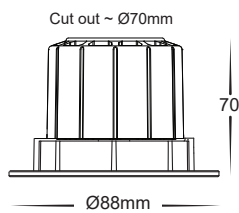

Prime HaviSMART Aluminium White

- Wifi LED Downlights
- Aluminium White
- Aluminium Heat Sink
- Supplied with dimmable driver complete with flex & plug
- 120° beam angle
- CRI>90
- IC-4 Rated (fitting only)
- IP Rating: IP54 (front only)

works with alexa
works with Hey Google
Powered by tuya Intelligence Inside
Compatible with major smart home systems.

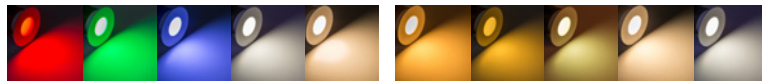

IC-4
Smart CCT By Havit
2700K 6500K
Havit



PART NUMBER	CUT OUT	COLOUR TEMP	LUMENS	INPUT	INCLUDED LED
HV5511CCT-WHT	70mm	2700K-6500K	330lm-340lm	240v	CCT Built-in 12w LED
HV5511RGBCW-WHT	70mm	RGBCW	300lm-320lm	240v	RGBCW Built-in 12w LED
HV5512CCT-WHT	90mm	2700K-6500K	330lm-340lm	240v	CCT Built-in 12w LED
HV5512RGBCW-WHT	90mm	RGBCW	300lm-320lm	240v	RGBCW Built-in 12w LED
HV5513CCT-WHT	76mm	2700K-6500K	330lm-340lm	240v	CCT Built-in 12w LED
HV5513RGBCW-WHT	76mm	RGBCW	300lm-320lm	240v	RGBCW Built-in 12w LED
HV5514CCT-WHT	90mm	2700K-6500K	330lm-340lm	240v	CCT Built-in 12w LED
HV5514RGBCW-WHT	90mm	RGBCW	300lm-320lm	240v	RGBCW Built-in 12w LED



HV5511T-WHT

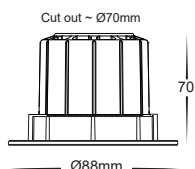

HV5512T-WHT

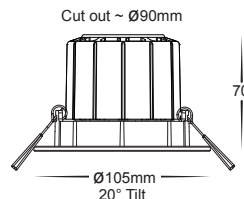

HV5513T-WHT

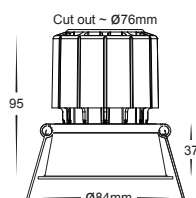

HV5514T-WHT

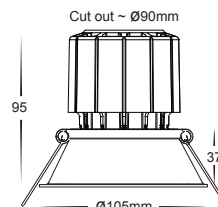

Prime Aluminium White

- Dimmable LED downlights
- Aluminium White
- Aluminium Heat Sink
- Supplied with dimmable driver complete with flex & plug
- 60° beam angle
- CRI > 90
- IC-4 Rated (fitting only)
- IP Rating: IP54 (front only)

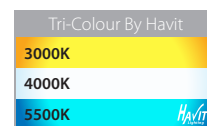

PART NUMBER	CUT OUT	COLOUR TEMP	LUMENS	INPUT	INCLUDED LED
HV5511T-WHT	70mm	3000K - 4000K - 5500K	839lm - 913lm - 841lm	240v	Tri-Colour Built-in 12w LED
HV5512T-WHT	90mm	3000K - 4000K - 5500K	839lm - 913lm - 841lm	240v	Tri-Colour Built-in 12w LED
HV5513T-WHT	76mm	3000K - 4000K - 5500K	839lm - 913lm - 841lm	240v	Tri-Colour Built-in 12w LED
HV5514T-WHT	90mm	3000K - 4000K - 5500K	839lm - 913lm - 841lm	240v	Tri-Colour Built-in 12w LED



For detailed product specifications
visit www.Havit.com.au
or scan this QR code



HV5522T-BLK
HV5522T-BLK-24V
 Polycarbonate Black

CUT OUT = Ø90mm

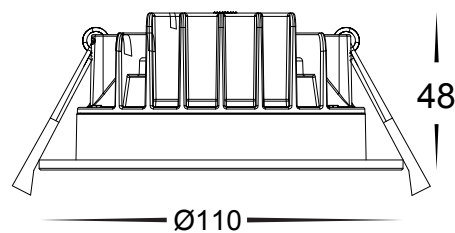

HV5522T-WHT
HV5522T-WHT-24V
 Polycarbonate White

Polly LED Downlight

- Fixed round LED downlight
- Polycarbonate matt black or white finish
- Integrated Triac Dimmable Driver
- Supplied with flex & plug (240v Model Only)
- Cut out: 90mm
- 120° beam angle
- IC-4 rated
- IP Rating: IP54 (front only)

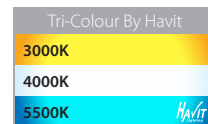

PART NUMBER	COLOUR TEMP	LUMENS	INPUT	INCLUDED LED
HV5522T-BLK	3000K - 4000K - 5500K	635lm - 750lm - 715lm	240V	Tri Colour Built in 8w LED
HV5522T-BLK-24V	3000K - 4000K - 5500K	635lm - 750lm - 715lm	24v DC	Tri Colour Built in 8w LED
HV5522T-WHT	3000K - 4000K - 5500K	635lm - 750lm - 715lm	240V	Tri Colour Built in 8w LED
HV5522T-WHT-24V	3000K - 4000K - 5500K	635lm - 750lm - 715lm	24v DC	Tri Colour Built in 8w LED

See pages 295-306 for compatible drivers. All low voltage products that specify an input of 12v or 24v DC must be used with a suitable LED driver.





**HV5528T-BLK
HV5528D2W-BLK
Polycarbonate Black**

CUT OUT = Ø90mm

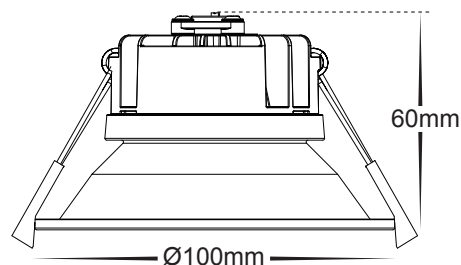

**HV5528T-WHT
HV5528D2W-WHT
Polycarbonate White**

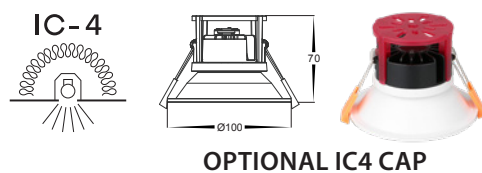

OPTIONAL IC4 CAP

Gleam LED Downlight

- Fixed round LED downlight
- Polycarbonate matt black or white finish
- Aluminium heat sink
- Dimmable LED driver with flex and plug
- Cut out: 90mm
- 90° beam angle
- IC-4 rated (Fitting Only) when used with IC-4 Cap
- IP Rating: IP54 (front only)

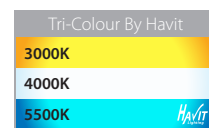

PART NUMBER	CUT OUT	COLOUR TEMP	LUMENS	INPUT	INCLUDED LED
HV5528T-BLK	90mm	3000K - 4000K - 5500K	680lm - 795lm - 745lm	240v	Tri-Colour Built-in 9w LED
HV5528D2W-BLK	90mm	1800K - 3000K	685lm	240v	Tri-Colour Built-in 9w LED
HV5528T-WHT	90mm	3000K - 4000K - 5500K	680lm - 795lm - 745lm	240v	Tri-Colour Built-in 9w LED
HV5528D2W-WHT	90mm	1800K - 3000K	685lm	240v	Tri-Colour Built-in 9w LED
HAVIT COMPATIBLE ACCESSORIES					
HV5528-IC4CAP	To be used with HV5528 Models to provide IC-4 rating				



For detailed product specifications
visit www.Havit.com.au
or scan this QR code



HV5528T-BC
HV5528D2W-BC



HV5528T-BG
HV5528D2W-BG



HV5528T-BB
HV5528D2W-BB



Gleam LED Downlight

- Fixed round LED downlight
- Aluminium Black with Polycarbonate Coloured Inserts
- Supplied with Triac Dimmable Driver with Flex & Plug
- Cut out: 90mm
- 90° beam angle
- IC-4 rated (Fitting Only)
- IP Rating: IP54 (front only)

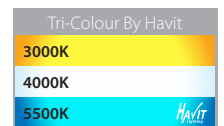
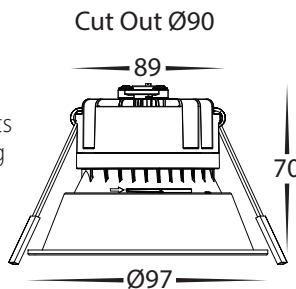

PART NUMBER	COLOUR TEMP	LUMENS	INPUT	INCLUDED LED
HV5528T-BB	3000K - 4000K - 5500K	680lm - 795lm - 745lm	240V	Tri-Colour Built in 9w LED
HV5528T-BC	3000K - 4000K - 5500K	680lm - 795lm - 745lm	240V	Tri-Colour Built in 9w LED
HV5528T-BG	3000K - 4000K - 5500K	680lm - 795lm - 745lm	240V	Tri-Colour Built in 9w LED
HV5528D2W-BB	1800K - 3000K	685lm	240V	Dim to Warm Built in 9w LED
HV5528D2W-BC	1800K - 3000K	685lm	240V	Dim to Warm Built in 9w LED
HV5528D2W-BG	1800K - 3000K	685lm	240V	Dim to Warm Built in 9w LED





**HV5528T-WB
HV5528D2W-WB**



**HV5528T-WC
HV5528D2W-WC**



**HV5528T-WG
HV5528D2W-WG**



**HV5528T-WW
HV5528D2W-WW**



Gleam LED Downlight

- Fixed round LED downlight
- Aluminium White with Polycarbonate Coloured Inserts
- Supplied with Triac Dimmable Driver with Flex & Plug
- Cut out: 90mm
- 90° beam angle
- IC-4 rated (Fitting Only)
- IP Rating: IP54 (front only)

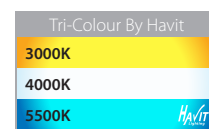
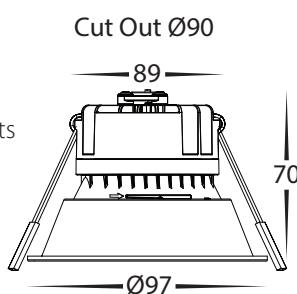

PART NUMBER	COLOUR TEMP	LUMENS	INPUT	INCLUDED LED
HV5528T-WB	3000K - 4000K - 5500K	680lm - 795lm - 745lm	240V	Tri-Colour Built in 9w LED
HV5528T-WC	3000K - 4000K - 5500K	680lm - 795lm - 745lm	240V	Tri-Colour Built in 9w LED
HV5528T-WG	3000K - 4000K - 5500K	680lm - 795lm - 745lm	240V	Tri-Colour Built in 9w LED
HV5528T-WW	3000K - 4000K - 5500K	680lm - 795lm - 745lm	240V	Tri-Colour Built in 9w LED
HV5528D2W-WB	1800K - 3000K	685lm	240V	Dim to Warm Built in 9w LED
HV5528D2W-WC	1800K - 3000K	685lm	240V	Dim to Warm Built in 9w LED
HV5528D2W-WG	1800K - 3000K	685lm	240V	Dim to Warm Built in 9w LED
HV5528D2W-WW	1800K - 3000K	685lm	240V	Dim to Warm Built in 9w LED



For detailed product specifications
visit www.Havit.com.au
or scan this QR code



HV5529T-BC
HV5529D2W-BC



HV5529T-BG
HV5529D2W-BG



HV5529T-BB
HV5529D2W-BB

Gleam LED Downlight

- Fixed round LED downlight
- Aluminium Black with Polycarbonate Coloured Inserts
- Supplied with Triac Dimmable Driver with Flex & Plug
- Cut out: 76mm
- 90° beam angle
- IC-4 rated (Fitting Only)
- IP Rating: IP54 (front only)

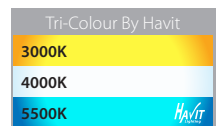
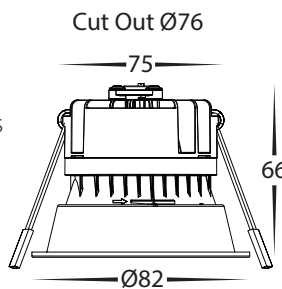

PART NUMBER	COLOUR TEMP	LUMENS	INPUT	INCLUDED LED
HV5529T-BB	3000K - 4000K - 5500K	680lm - 795lm - 745lm	240V	Tri-Colour Built in 9w LED
HV5529T-BC	3000K - 4000K - 5500K	680lm - 795lm - 745lm	240V	Tri-Colour Built in 9w LED
HV5529T-BG	3000K - 4000K - 5500K	680lm - 795lm - 745lm	240V	Tri-Colour Built in 9w LED
HV5529D2W-BB	1800K - 3000K	685lm	240V	Dim to Warm Built in 9w LED
HV5529D2W-BC	1800K - 3000K	685lm	240V	Dim to Warm Built in 9w LED
HV5529D2W-BG	1800K - 3000K	685lm	240V	Dim to Warm Built in 9w LED





HV5529T-WB
HV5529D2W-WB



HV5529T-WC
HV5529D2W-WC



HV5529T-WG
HV5529D2W-WG



HV5529T-WW
HV5529D2W-WW

Gleam LED Downlight

- Fixed round LED downlight
- Aluminium White with Polycarbonate Coloured Inserts
- Supplied with Triac Dimmable Driver with Flex & Plug
- Cut out: 76mm
- 90° beam angle
- IC-4 rated (Fitting Only)
- IP Rating: IP54 (front only)

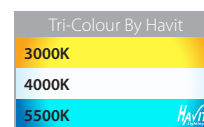
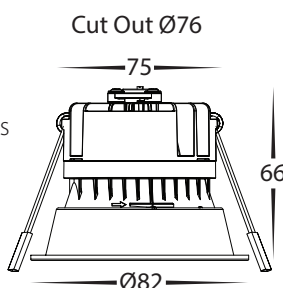

PART NUMBER	COLOUR TEMP	LUMENS	INPUT	INCLUDED LED
HV5529T-WB	3000K - 4000K - 5500K	680lm - 795lm - 745lm	240V	Tri-Colour Built in 9w LED
HV5529T-WC	3000K - 4000K - 5500K	680lm - 795lm - 745lm	240V	Tri-Colour Built in 9w LED
HV5529T-WG	3000K - 4000K - 5500K	680lm - 795lm - 745lm	240V	Tri-Colour Built in 9w LED
HV5529T-WW	3000K - 4000K - 5500K	680lm - 795lm - 745lm	240V	Tri-Colour Built in 9w LED
HV5529D2W-WB	1800K - 3000K	685lm	240V	Dim to Warm Built in 9w LED
HV5529D2W-WC	1800K - 3000K	685lm	240V	Dim to Warm Built in 9w LED
HV5529D2W-WG	1800K - 3000K	685lm	240V	Dim to Warm Built in 9w LED
HV5529D2W-WW	1800K - 3000K	685lm	240V	Dim to Warm Built in 9w LED



For detailed product specifications
visit www.Havit.com.au
or scan this QR code



HV5530S-SS316



Cut out ~ Ø90mm

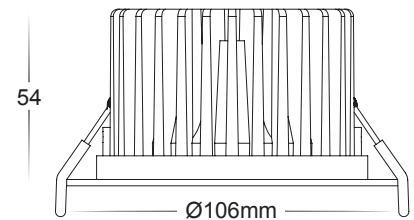

Ora 316 Stainless Steel

- Fixed round LED downlight
- Stainless Steel 316 Marine Grade cover
- Aluminium Heat Sink
- Supplied with dimmable driver complete with flex & plug
- Cut out: 90mm
- 60° beam angle
- IC-4 Rated (fitting only)
- IP Rating: IP54 (front only)



PART NUMBER	COLOUR TEMP	LUMENS	INPUT	INCLUDED LED
HV5530S-SS316	2700K - 3000K - 4000K - 5000K - 6000K	890lm - 935lm - 1020lm - 1095lm - 1105lm	240V	Five-Colour Built-in 12w LED





HV5530T-BLK
Aluminium Black



HV5530T-WHT
Aluminium White



HV5531T-BLK
Aluminium Black



HV5531T-WHT
Aluminium White

Ora Aluminium

- Fixed round LED downlight
- Aluminium Black or White
- Aluminium heat sink
- Supplied with dimmable driver complete with flex & plug
- Cut out: 90mm
- 90° beam angle (HV5530T)
- 40° beam Angle (HV5531T)
- IC-4 Rated (fitting only)
- IP Rating: IP54 (front only)

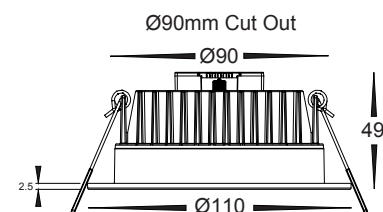
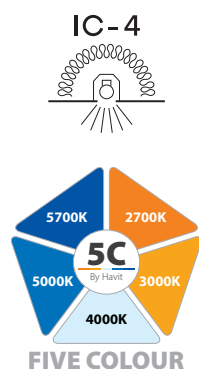

PART NUMBER	COLOUR TEMP	LUMENS	INPUT	INCLUDED LED
HV5530T-BLK	2700K - 3000K - 4000K - 5000K - 5700K	900lm - 938lm - 1024lm - 1092lm - 1110lm	240V	Five-Colour Built-in 13w LED
HV5530T-WHT	2700K - 3000K - 4000K - 5000K - 5700K	900lm - 938lm - 1024lm - 1092lm - 1110lm	240V	Five-Colour Built-in 13w LED
HV5531T-BLK	2700K - 3000K - 4000K - 5000K - 5700K	952lm - 973lm - 1072lm - 1019lm - 1135lm	240V	Five-Colour Built-in 13w LED
HV5531T-WHT	2700K - 3000K - 4000K - 5000K - 5700K	952lm - 973lm - 1072lm - 1019lm - 1135lm	240V	Five-Colour Built-in 13w LED



For detailed product specifications
visit www.Havit.com.au
or scan this QR code



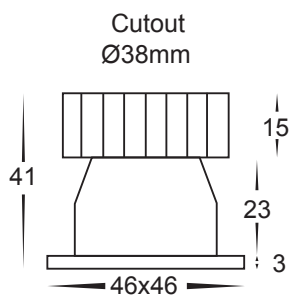
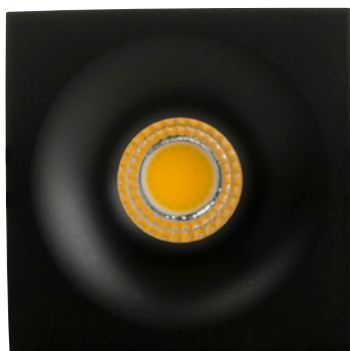

HV5701T-BLK
Aluminium Black

HV5701T-WHT
Aluminium White

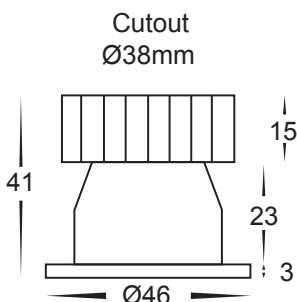

HV5702T-BLK
Aluminium Black

HV5702T-WHT
Aluminium White



Niche Aluminium

- Mini LED downlight
- Aluminium Black or White
- Aluminium Heat Sink
- Supplied with Dimmable LED driver complete with flex and plug
- Cut out: 38mm
- 45° beam angle
- IC-4 Rated (fitting only)
- IP Rating: IP54 (Front of fitting)

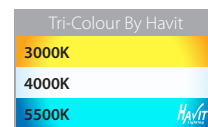

PART NUMBER	COLOUR TEMP	LUMENS	INPUT	INCLUDED LED
HV5701T-BLK	3000K - 4000K - 5500K	240lm - 265lm - 270lm	240V	Tri-Colour Built-in 3w LED
HV5701T-WHT	3000K - 4000K - 5500K	240lm - 265lm - 270lm	240V	Tri-Colour Built-in 3w LED
HV5702T-BLK	3000K - 4000K - 5500K	240lm - 265lm - 270lm	240V	Tri-Colour Built-in 3w LED
HV5702T-WHT	3000K - 4000K - 5500K	240lm - 265lm - 270lm	240V	Tri-Colour Built-in 3w LED



For detailed product specifications
visit www.Havit.com.au
or scan this QR code

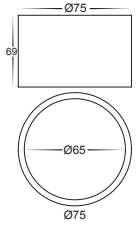

HV5802T-BLK
HV5802T-BLK-12V

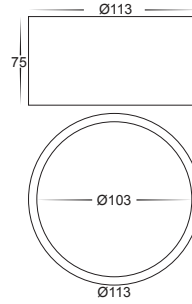

HV5803T-BLK
HV5803T-BLK-12V

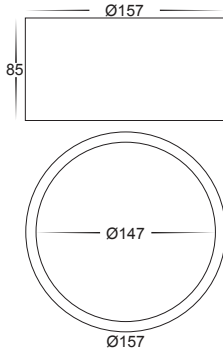

HV5805T-BLK
HV5805T-BLK-12V



OPTIONAL GOLD ADAPTOR RINGS



HV58100-GR



HV58101-GR



HV58102-GR



Nella Aluminium Black

- Surface mounted round downlight
- Aluminium Powder Coated Black
- Triac Dimmable (240V Model Only)
- 120° beam angle
- IP Rating: IP54

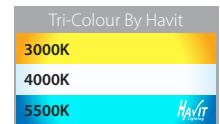

PART NUMBER	COLOUR TEMP	LUMENS	INPUT	INCLUDED LED
HV5802T-BLK	3000K - 4000K - 5500K	525lm - 560lm - 540lm	240V	Tri-Colour Built in 7w LED
HV5802T-BLK-12V	3000K - 4000K - 5500K	525lm - 560lm - 540lm	12V DC	Tri-Colour Built in 7w LED
HV5803T-BLK	3000K - 4000K - 5500K	995lm - 1125lm - 1050lm	240V	Tri-Colour Built in 12w LED
HV5803T-BLK-12V	3000K - 4000K - 5500K	995lm - 1125lm - 1050lm	12V DC	Tri-Colour Built in 12w LED
HV5805T-BLK	3000K - 4000K - 5500K	1380lm - 1430lm - 1305lm	240V	Tri-Colour Built in 18w LED
HV5805T-BLK-12V	3000K - 4000K - 5500K	1380lm - 1430lm - 1305lm	12V DC	Tri-Colour Built in 18w LED

HAVIT COMPATIBLE ACCESSORIES

HV58100-GR	Gold Adaptor ring to suit HV5802, HV5812, HV5841 Surface Mounted Downlight Models
HV58101-GR	Gold Adaptor ring to suit HV5803, HV5815, HV5843 Surface Mounted Downlight Models
HV58102-GR	Gold Adaptor ring to suit HV5805 Surface Mounted Downlight Models

See pages 295-306 for compatible drivers. All low voltage products that specify an input of 12v or 24v DC must be used with a suitable LED driver.



Surface Mounted Downlights & Pendants

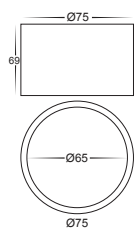

HV5802T-WHT
HV5802T-WHT-12V

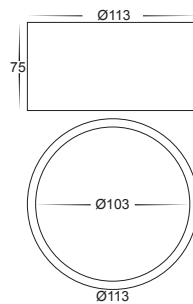

HV5803T-WHT
HV5803T-WHT-12V

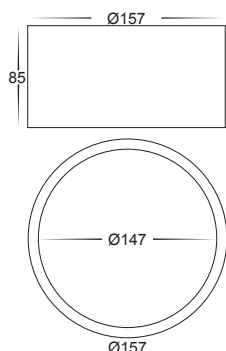

HV5805T-WHT
HV5805T-WHT-12V



OPTIONAL GOLD ADAPTOR RINGS



HV58100-GR



HV58101-GR



HV58102-GR



Nella Aluminium White

- Surface mounted round downlight
- Aluminium Powder Coated White
- Triac Dimmable (240V Model Only)
- 120° beam angle
- IP Rating: IP54

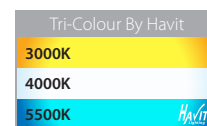

PART NUMBER	COLOUR TEMP	LUMENS	INPUT	INCLUDED LED
HV5802T-WHT	3000K - 4000K - 5500K	525lm - 560lm - 540lm	240V	Tri-Colour Built in 7w LED
HV5802T-WHT-12V	3000K - 4000K - 5500K	525lm - 560lm - 540lm	12V DC	Tri-Colour Built in 7w LED
HV5803T-WHT	3000K - 4000K - 5500K	995lm - 1125lm - 1050lm	240V	Tri-Colour Built in 12w LED
HV5803T-WHT-12V	3000K - 4000K - 5500K	995lm - 1125lm - 1050lm	12V DC	Tri-Colour Built in 12w LED
HV5805T-WHT	3000K - 4000K - 5500K	1380lm - 1430lm - 1305lm	240V	Tri-Colour Built in 18w LED
HV5805T-WHT-12V	3000K - 4000K - 5500K	1380lm - 1430lm - 1305lm	12V DC	Tri-Colour Built in 18w LED

HAVIT COMPATIBLE ACCESSORIES

HV58100-GR	Gold Adaptor ring to suit HV5802, HV5812, HV5841 Surface Mounted Downlight Models
HV58101-GR	Gold Adaptor ring to suit HV5803, HV5815, HV5843 Surface Mounted Downlight Models
HV58102-GR	Gold Adaptor ring to suit HV5805 Surface Mounted Downlight Models

See pages 295-306 for compatible drivers. All low voltage products that specify an input of 12v or 24v DC must be used with a suitable LED driver.



For detailed product specifications
visit www.Havit.com.au
or scan this QR code

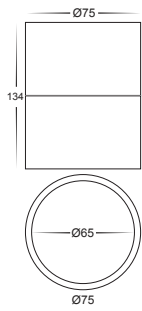

HV5802T-BLK-EXT
HV5802T-BLK-EXT-12V

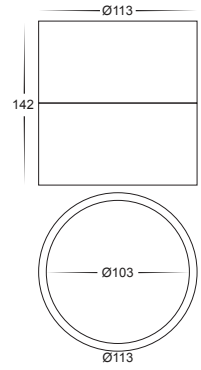

HV5803T-BLK-EXT
HV5803T-BLK-EXT-12V

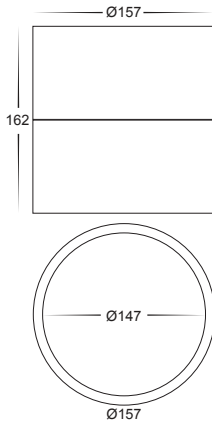

HV5805T-BLK-EXT
HV5805T-BLK-EXT-12V



OPTIONAL GOLD ADAPTOR RINGS



HV58100-GR



HV58101-GR



HV58102-GR



Nella Aluminium Black

- Surface mounted round downlight with extension
- Aluminium Powder Coated Black
- Triac Dimmable (240V Model Only)
- 120° beam angle
- IP Rating: IP54

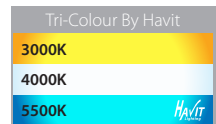

PART NUMBER	COLOUR TEMP	LUMENS	INPUT	INCLUDED LED
HV5802T-BLK-EXT	3000K - 4000K - 5500K	525lm - 560lm - 540lm	240V	Tri-Colour Built in 7w LED
HV5802T-BLK-EXT-12V	3000K - 4000K - 5500K	525lm - 560lm - 540lm	12V DC	Tri-Colour Built in 7w LED
HV5803T-BLK-EXT	3000K - 4000K - 5500K	995lm - 1125lm - 1050lm	240V	Tri-Colour Built in 12w LED
HV5803T-BLK-EXT-12V	3000K - 4000K - 5500K	995lm - 1125lm - 1050lm	12V DC	Tri-Colour Built in 12w LED
HV5805T-BLK-EXT	3000K - 4000K - 5500K	1380lm - 1430lm - 1305lm	240V	Tri-Colour Built in 18w LED
HV5805T-BLK-EXT-12V	3000K - 4000K - 5500K	1380lm - 1430lm - 1305lm	12V DC	Tri-Colour Built in 18w LED

HAVIT COMPATIBLE ACCESSORIES

HV58100-GR	Gold Adaptor ring to suit HV5802, HV5812, HV5841 Surface Mounted Downlight Models
HV58101-GR	Gold Adaptor ring to suit HV5803, HV5815, HV5843 Surface Mounted Downlight Models
HV58102-GR	Gold Adaptor ring to suit HV5805 Surface Mounted Downlight Models

See pages 295-306 for compatible drivers. All low voltage products that specify an input of 12v or 24v DC must be used with a suitable LED driver.



Surface Mounted Downlights & Pendants

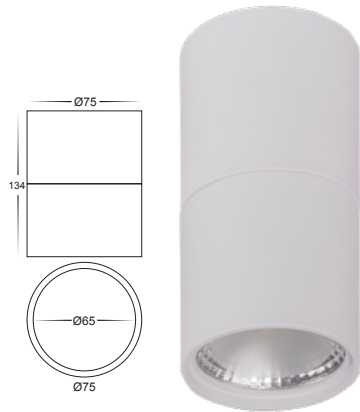

HV5802T-WHT-EXT
HV5802T-WHT-EXT-12V

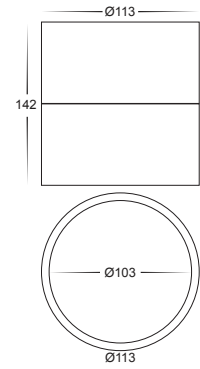

HV5803T-WHT-EXT
HV5803T-WHT-EXT-12V

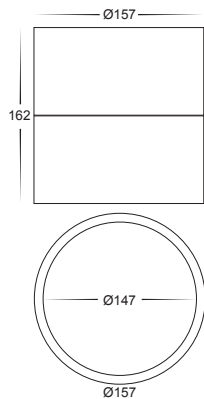

HV5805T-WHT-EXT
HV5805T-WHT-EXT-12V



OPTIONAL GOLD ADAPTOR RINGS

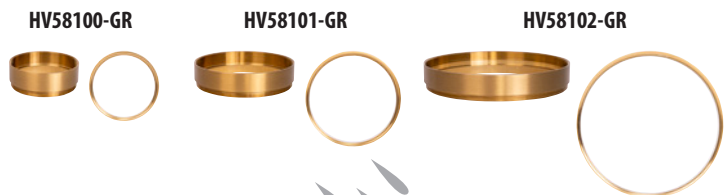

Nella Aluminium White

- Surface mounted round downlight with extension
- Aluminium Powder Coated White
- Triac Dimmable (240V Model Only)
- 120° beam angle
- IP Rating: IP54

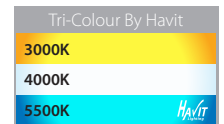

PART NUMBER	COLOUR TEMP	LUMENS	INPUT	INCLUDED LED
HV5802T-WHT-EXT	3000K - 4000K - 5500K	525lm - 560lm - 540lm	240V	Tri-Colour Built in 7w LED
HV5802T-WHT-EXT-12V	3000K - 4000K - 5500K	525lm - 560lm - 540lm	12V DC	Tri-Colour Built in 7w LED
HV5803T-WHT-EXT	3000K - 4000K - 5500K	995lm - 1125lm - 1050lm	240V	Tri-Colour Built in 12w LED
HV5803T-WHT-EXT-12V	3000K - 4000K - 5500K	995lm - 1125lm - 1050lm	12V DC	Tri-Colour Built in 12w LED
HV5805T-WHT-EXT	3000K - 4000K - 5500K	1380lm - 1430lm - 1305lm	240V	Tri-Colour Built in 18w LED
HV5805T-WHT-EXT-12V	3000K - 4000K - 5500K	1380lm - 1430lm - 1305lm	12V DC	Tri-Colour Built in 18w LED

HAVIT COMPATIBLE ACCESSORIES

HV58100-GR	Gold Adaptor ring to suit HV5802, HV5812, HV5841 Surface Mounted Downlight Models
HV58101-GR	Gold Adaptor ring to suit HV5803, HV5815, HV5843 Surface Mounted Downlight Models
HV58102-GR	Gold Adaptor ring to suit HV5805 Surface Mounted Downlight Models

See pages 295-306 for compatible drivers. All low voltage products that specify an input of 12v or 24v DC must be used with a suitable LED driver.



For detailed product specifications
visit www.Havit.com.au
or scan this QR code



HV5802T-BLK-P



HV5803T-BLK-P



HV5805T-BLK-P

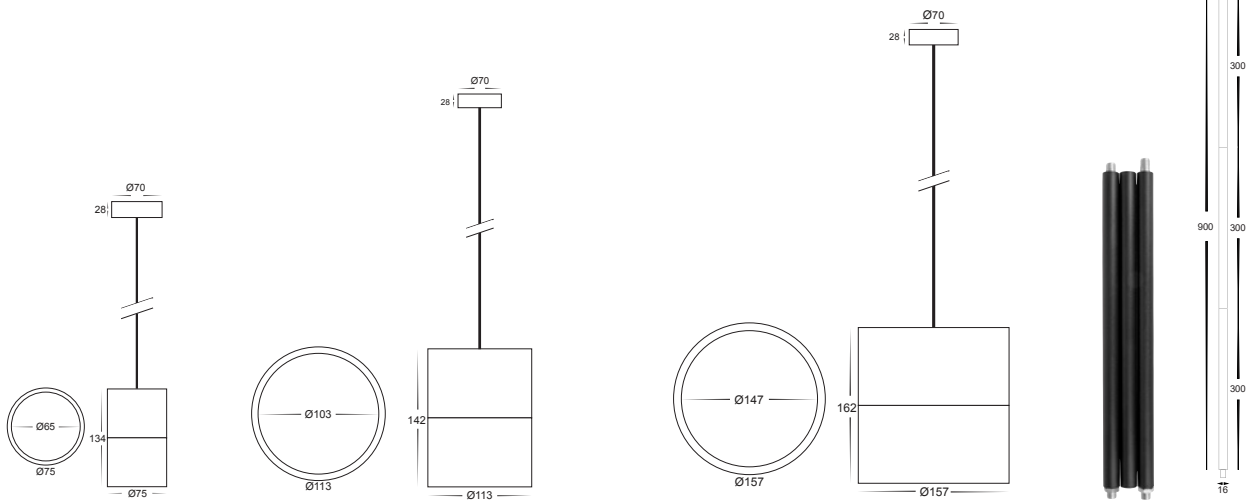

HV580X-BLK-ROD

Nella Aluminium Black Pendants

- Single pendant light
- Aluminium Powder Coated Black
- Triac Dimmable
- 120° beam angle
- Cable length: 1500mm Adjustable
- IP Rating: IP20

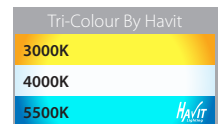

PART NUMBER	COLOUR TEMP	LUMENS	INPUT	INCLUDED LED
HV5802T-BLK-P	3000K - 4000K - 5500K	525lm - 560lm - 540lm	240V	Tri-Colour Built-in 7w LED
HV5803T-BLK-P	3000K - 4000K - 5500K	995lm - 1125lm - 1050lm	240V	Tri-Colour Built-in 12w LED
HV5805T-BLK-P	3000K - 4000K - 5500K	1380lm - 1430lm - 1305lm	240V	Tri-Colour Built-in 18w LED
HAVIT COMPATIBLE ACCESSORIES				
HV580X-BLK-ROD	900mm (3x 300mm) Rod to suit Nella Pendants			





HV5802T-WHT-P



HV5803T-WHT-P



HV5805T-WHT-P

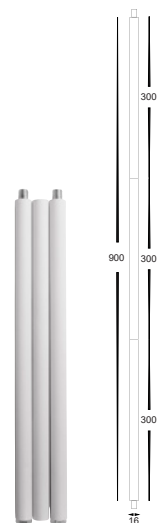
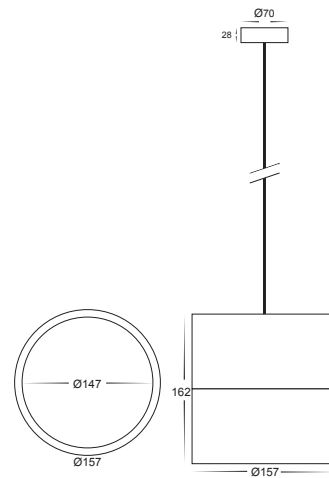
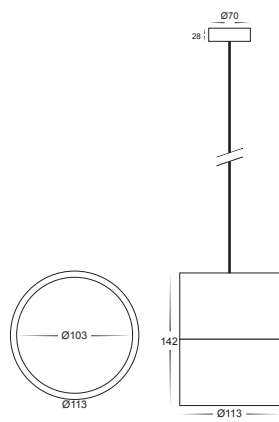
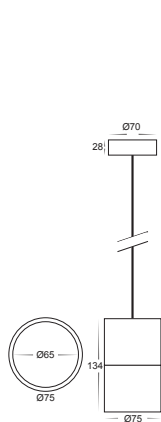

HV580X-WHT-ROD

Nella Aluminium White Pendants

- Single pendant light
- Aluminium Powder Coated White
- Triac Dimmable
- 120° beam angle
- Cable length: 1500mm Adjustable
- IP Rating: IP20

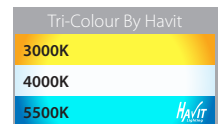

PART NUMBER	COLOUR TEMP	LUMENS	INPUT	INCLUDED LED
HV5802T-WHT-P	3000K - 4000K - 5500K	525lm - 560lm - 540lm	240V	Tri-Colour Built-in 7w LED
HV5803T-WHT-P	3000K - 4000K - 5500K	995lm - 1125lm - 1050lm	240V	Tri-Colour Built-in 12w LED
HV5805T-WHT-P	3000K - 4000K - 5500K	1380lm - 1430lm - 1305lm	240V	Tri-Colour Built-in 18w LED
HAVIT COMPATIBLE ACCESSORIES				
HV580X-WHT-ROD	900mm (3x 300mm) Rod to suit Nella Pendants			



For detailed product specifications visit www.Havit.com.au or scan this QR code



HV5812T-BLK
HV5812T-BLK-12V

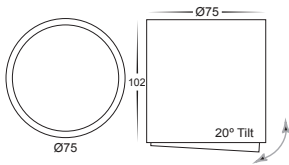

HV5813T-BLK
HV5813T-BLK-12V

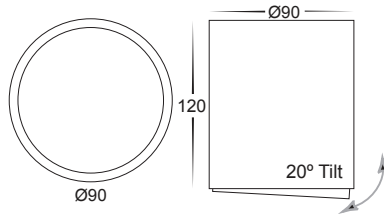

HV5815T-BLK
HV5815T-BLK-12V

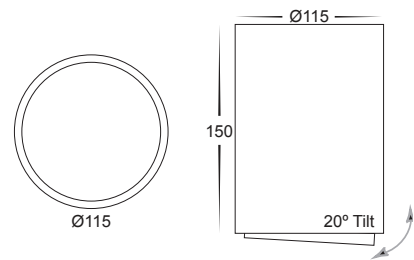

OPTIONAL GOLD ADAPTOR RINGS

HV58100-GR

HV58101-GR

HV58103-GR



Nella Adjustable Aluminium Black

- Surface mounted adjustable round downlight
- Aluminium Powder Coated Black
- Triac Dimmable (240V Model Only)
- 20° Tilt
- 60° beam angle
- IP Rating: IP40

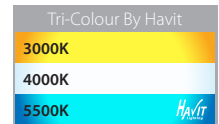

PART NUMBER	COLOUR TEMP	LUMENS	INPUT	INCLUDED LED
HV5812T-BLK	3000K - 4000K - 5500K	600lm - 640lm - 605lm	240V	Tri-Colour Built in 7w LED
HV5812T-BLK-12V	3000K - 4000K - 5500K	600lm - 640lm - 605lm	12V DC	Tri-Colour Built in 7w LED
HV5813T-BLK	3000K - 4000K - 5500K	980lm - 1015lm - 985lm	240V	Tri-Colour Built in 12w LED
HV5813T-BLK-12V	3000K - 4000K - 5500K	980lm - 1015lm - 985lm	12V DC	Tri-Colour Built in 12w LED
HV5815T-BLK	3000K - 4000K - 5500K	1100lm - 1120lm - 1110lm	240V	Tri-Colour Built in 18w LED
HV5815T-BLK-12V	3000K - 4000K - 5500K	1100lm - 1120lm - 1110lm	12V DC	Tri-Colour Built in 18w LED

HAVIT COMPATIBLE ACCESSORIES

HV58100-GR	Gold Adaptor ring to suit HV5802, HV5812, HV5841 Surface Mounted Downlight Models
HV58101-GR	Gold Adaptor ring to suit HV5803, HV5815, HV5843 Surface Mounted Downlight Models
HV58103-GR	Gold Adaptor ring to suit HV5813, HV5842 Surface Mounted Downlight Models

See pages 295-306 for compatible drivers. All low voltage products that specify an input of 12v or 24v DC must be used with a suitable LED driver.





HV5812T-WHT
HV5812T-WHT-12V

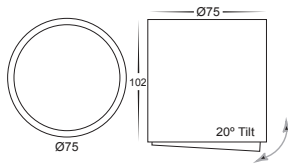

HV5813T-WHT
HV5813T-WHT-12V

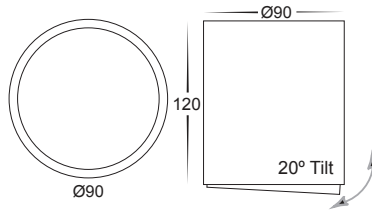

HV5815T-WHT
HV5815T-WHT-12V

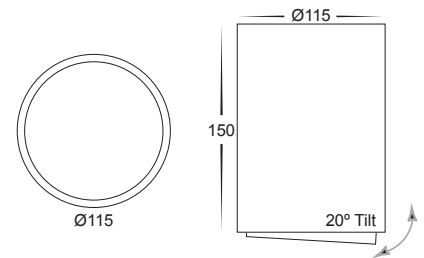

OPTIONAL GOLD ADAPTOR RINGS

HV58100-GR

HV58101-GR

HV58103-GR



Nella Adjustable Aluminium White

- Surface mounted adjustable round downlight
- Aluminium Powder Coated White
- Triac Dimmable (240V Model Only)
- 20° Tilt
- 60° beam angle
- IP Rating: IP40

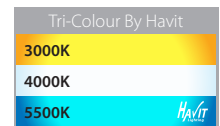

PART NUMBER	COLOUR TEMP	LUMENS	INPUT	INCLUDED LED
HV5812T-WHT	3000K - 4000K - 5500K	600lm - 640lm - 605lm	240V	Tri-Colour Built in 7w LED
HV5812T-WHT-12V	3000K - 4000K - 5500K	600lm - 640lm - 605lm	12V DC	Tri-Colour Built in 7w LED
HV5813T-WHT	3000K - 4000K - 5500K	980lm - 1015lm - 985lm	240V	Tri-Colour Built in 12w LED
HV5813T-WHT-12V	3000K - 4000K - 5500K	980lm - 1015lm - 985lm	12V DC	Tri-Colour Built in 12w LED
HV5815T-WHT	3000K - 4000K - 5500K	1100lm - 1120lm - 1110lm	240V	Tri-Colour Built in 18w LED
HV5815T-WHT-12V	3000K - 4000K - 5500K	1100lm - 1120lm - 1110lm	12V DC	Tri-Colour Built in 18w LED

HAVIT COMPATIBLE ACCESSORIES

HV58100-GR	Gold Adaptor ring to suit HV5802, HV5812, HV5841 Surface Mounted Downlight Models
HV58101-GR	Gold Adaptor ring to suit HV5803, HV5815, HV5843 Surface Mounted Downlight Models
HV58103-GR	Gold Adaptor ring to suit HV5813, HV5842 Surface Mounted Downlight Models

See pages 295-306 for compatible drivers. All low voltage products that specify an input of 12v or 24v DC must be used with a suitable LED driver.



For detailed product specifications
visit www.Havit.com.au
or scan this QR code

HV5822T-BLK
HV5822T-BLK-12V



HV5823T-BLK
HV5823T-BLK-12V



HV5824T-BLK
HV5824T-BLK-12V



HV5825T-BLK
HV5825T-BLK-12V

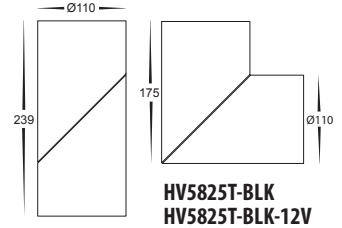
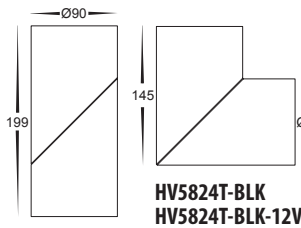
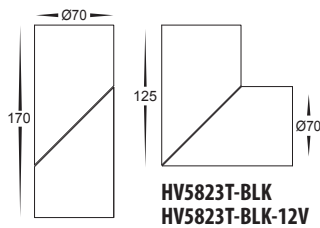
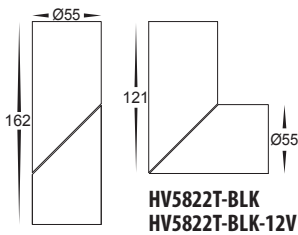

Nella Rotatable Aluminium

- Surface mounted rotatable round downlight
- Aluminium Powder Coated Black
- Triac Dimmable (240V Model Only)
- 90° Rotation
- HV5822 + HV5823 = 36° Beam Angle
- HV5824 + HV5825 = 60° Beam Angle
- IP Rating: IP54

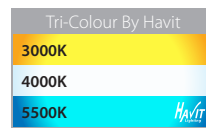

PART NUMBER	COLOUR TEMP	LUMENS	INPUT	INCLUDED LED
HV5822T-BLK	3000K - 4000K - 5500K	395lm - 485lm - 465lm	240V	Tri-Colour Built in 7w LED
HV5822T-BLK-12V	3000K - 4000K - 5500K	395lm - 485lm - 465lm	12V DC	Tri-Colour Built in 7w LED
HV5823T-BLK	3000K - 4000K - 5500K	790lm - 880lm - 855lm	240V	Tri-Colour Built in 12w LED
HV5823T-BLK-12V	3000K - 4000K - 5500K	790lm - 880lm - 855lm	12V DC	Tri-Colour Built in 12w LED
HV5824T-BLK	3000K - 4000K - 5500K	1415lm - 1600lm - 1485lm	240V	Tri-Colour Built in 18w LED
HV5824T-BLK-12V	3000K - 4000K - 5500K	1415lm - 1600lm - 1485lm	12V DC	Tri-Colour Built in 18w LED
HV5825T-BLK	3000K - 4000K - 5500K	2100lm - 2320lm - 2270lm	240V	Tri-Colour Built in 24w LED
HV5825T-BLK-12V	3000K - 4000K - 5500K	2100lm - 2320lm - 2270lm	12V DC	Tri-Colour Built in 24w LED

See pages 295-306 for compatible drivers. All low voltage products that specify an input of 12v or 24v DC must be used with a suitable LED driver.



HV5822T-WHT
HV5822T-WHT-12V



HV5823T-WHT
HV5823T-WHT-12V



HV5824T-WHT
HV5824T-WHT-12V



HV5825T-WHT
HV5825T-WHT-12V

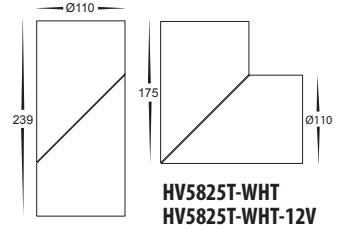
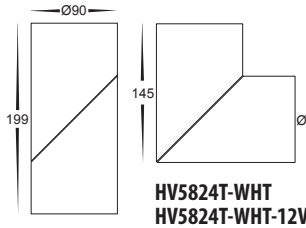
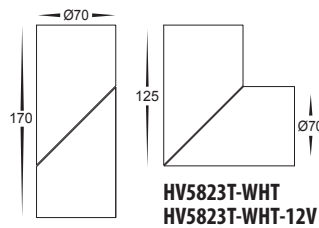
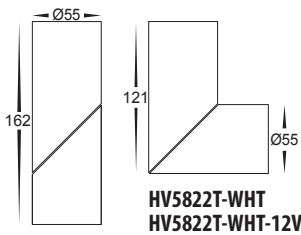

Nella Rotatable Aluminium

- Surface mounted rotatable round downlight
- Aluminium Powder Coated White
- Triac Dimmable (240V Model Only)
- 90° Rotation
- HV5822 + HV5823 = 36° Beam Angle
- HV5824 + HV5825 = 60° Beam Angle
- IP Rating: IP54

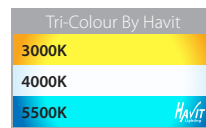

PART NUMBER	COLOUR TEMP	LUMENS	INPUT	INCLUDED LED
HV5822T-WHT	3000K - 4000K - 5500K	395lm - 485lm - 465lm	240V	Tri-Colour Built in 7w LED
HV5822T-WHT-12V	3000K - 4000K - 5500K	395lm - 485lm - 465lm	12V DC	Tri-Colour Built in 7w LED
HV5823T-WHT	3000K - 4000K - 5500K	790lm - 880lm - 855lm	240V	Tri-Colour Built in 12w LED
HV5823T-WHT-12V	3000K - 4000K - 5500K	790lm - 880lm - 855lm	12V DC	Tri-Colour Built in 12w LED
HV5824T-WHT	3000K - 4000K - 5500K	1415lm - 1600lm - 1485lm	240V	Tri-Colour Built in 18w LED
HV5824T-WHT-12V	3000K - 4000K - 5500K	1415lm - 1600lm - 1485lm	12V DC	Tri-Colour Built in 18w LED
HV5825T-WHT	3000K - 4000K - 5500K	2100lm - 2320lm - 2270lm	240V	Tri-Colour Built in 24w LED
HV5825T-WHT-12V	3000K - 4000K - 5500K	2100lm - 2320lm - 2270lm	12V DC	Tri-Colour Built in 24w LED

See pages 295-306 for compatible drivers. All low voltage products that specify an input of 12v or 24v DC must be used with a suitable LED driver.



For detailed product specifications
visit www.Havit.com.au
or scan this QR code



HV5831T-BLK



HV5831T-WHT



HV5832T-BLK



HV5832T-WHT

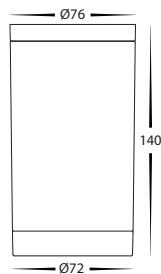

HV5831T

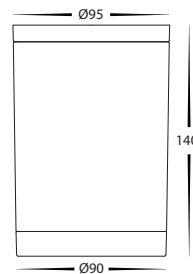

HV5832T

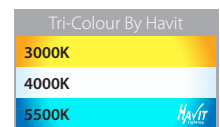

Lexan

- Surface Mounted Downlight
- Polycarbonate Black or White
- IP Rating: IP54

PART NUMBER	COLOUR TEMP	LUMENS	INPUT	INCLUDED LED
HV5831T-BLK	3000K - 4000K - 5500K	240-560lm - 255-595lm - 270-630lm	240V	9 in 1 Tri-Colour 3/5/7w GU10 LED
HV5831T-WHT	3000K - 4000K - 5500K	240-560lm - 255-595lm - 270-630lm	240V	9 in 1 Tri-Colour 3/5/7w GU10 LED
HV5832T-BLK	3000K - 4000K - 5500K	240-560lm - 255-595lm - 270-630lm	240V	9 in 1 Tri-Colour 3/5/7w GU10 LED
HV5832T-WHT	3000K - 4000K - 5500K	240-560lm - 255-595lm - 270-630lm	240V	9 in 1 Tri-Colour 3/5/7w GU10 LED



For detailed product specifications visit www.Havit.com.au or scan this QR code

HV5841S-BLK
HV5841S-BLK-12V



HV5841S-BLK-EXT
HV5841S-BLK-EXT-12V

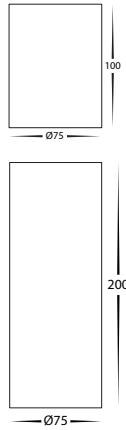

HV5841S-WHT
HV5841S-WHT-12V



HV5841S-WHT-EXT
HV5841S-WHT-EXT-12V



OPTIONAL GOLD ADAPTOR RINGS



Nella Aluminium

- Surface Mounted Round Downlight
- Aluminium Powder Coated Black or White
- Triac Dimmable (240V Model Only)
- 60° Beam Angle
- Supplied with Honeycomb Anti Glare Lens (can be removed)
- Optional Coloured Inserts
- IP Rating: IP54



PART NUMBER	COLOUR TEMP	LUMENS	INPUT	INCLUDED LED
HV5841S-BLK	2700K - 3000K - 4000K - 5000K - 5700K	499lm - 512lm - 558lm - 593lm - 601lm	240V	Five-Colour Built in 7w LED
HV5841S-BLK-12V	2700K - 3000K - 4000K - 5000K - 5700K	499lm - 512lm - 558lm - 593lm - 601lm	12V DC	Five-Colour Built in 7w LED
HV5841S-BLK-EXT	2700K - 3000K - 4000K - 5000K - 5700K	499lm - 512lm - 558lm - 593lm - 601lm	240V	Five-Colour Built in 7w LED
HV5841S-BLK-EXT-12V	2700K - 3000K - 4000K - 5000K - 5700K	499lm - 512lm - 558lm - 593lm - 601lm	12V DC	Five-Colour Built in 7w LED
HV5841S-WHT	2700K - 3000K - 4000K - 5000K - 5700K	499lm - 512lm - 558lm - 593lm - 601lm	240V	Five-Colour Built in 7w LED
HV5841S-WHT-12V	2700K - 3000K - 4000K - 5000K - 5700K	499lm - 512lm - 558lm - 593lm - 601lm	12V DC	Five-Colour Built in 7w LED
HV5841S-WHT-EXT	2700K - 3000K - 4000K - 5000K - 5700K	499lm - 512lm - 558lm - 593lm - 601lm	240V	Five-Colour Built in 7w LED
HV5841S-WHT-EXT-12V	2700K - 3000K - 4000K - 5000K - 5700K	499lm - 512lm - 558lm - 593lm - 601lm	12V DC	Five-Colour Built in 7w LED

HAVIT COMPATIBLE ACCESSORIES

HV5841-GR	Gold Insert to suit HV5841 Models
HV5841-CR	Chrome Insert to suit HV5841 Models
HV5841-BR	Black Insert to suit HV5841 Models
HV58100-GR	Gold Adaptor ring to suit HV5802, HV5812, HV5841 Surface Mounted Downlight Models
HV5841-BLK-PDT	3M Pendant accessory to convert downlight into Pendant
HV5841-WHT-PDT	3M Pendant accessory to convert downlight into Pendant

See pages 295-306 for compatible drivers. All low voltage products that specify an input of 12v or 24v DC must be used with a suitable LED driver.



Surface Mounted Downlights & Pendants



Nella Aluminium

- Surface Mounted Round Downlight
- Aluminium Powder Coated Black or White
- Triac Dimmable (240V Model Only)
- 60° Beam Angle
- Supplied with Honeycomb Anti Glare Lens (can be removed)
- Optional Coloured Inserts
- IP Rating: IP54



PART NUMBER	COLOUR TEMP	LUMENS	INPUT	INCLUDED LED
HV5842S-BLK	2700K - 3000K - 4000K - 5000K - 5700K	688lm - 840lm - 916lm - 931lm - 1004lm	240V	Five-Colour Built in 12w LED
HV5842S-BLK-12V	2700K - 3000K - 4000K - 5000K - 5700K	688lm - 840lm - 916lm - 931lm - 1004lm	12V DC	Five-Colour Built in 12w LED
HV5842S-BLK-EXT	2700K - 3000K - 4000K - 5000K - 5700K	688lm - 840lm - 916lm - 931lm - 1004lm	240V	Five-Colour Built in 12w LED
HV5842S-BLK-EXT-12V	2700K - 3000K - 4000K - 5000K - 5700K	688lm - 840lm - 916lm - 931lm - 1004lm	12V DC	Five-Colour Built in 12w LED
HV5842S-WHT	2700K - 3000K - 4000K - 5000K - 5700K	688lm - 840lm - 916lm - 931lm - 1004lm	240V	Five-Colour Built in 12w LED
HV5842S-WHT-12V	2700K - 3000K - 4000K - 5000K - 5700K	688lm - 840lm - 916lm - 931lm - 1004lm	12V DC	Five-Colour Built in 12w LED
HV5842S-WHT-EXT	2700K - 3000K - 4000K - 5000K - 5700K	688lm - 840lm - 916lm - 931lm - 1004lm	240V	Five-Colour Built in 12w LED
HV5842S-WHT-EXT-12V	2700K - 3000K - 4000K - 5000K - 5700K	688lm - 840lm - 916lm - 931lm - 1004lm	12V DC	Five-Colour Built in 12w LED

HAVIT COMPATIBLE ACCESSORIES

HV5842-GR	Gold Insert to suit HV5842 Models
HV5842-CR	Chrome Insert to suit HV5842 Models
HV5842-BR	Black Insert to suit HV5842 Models
HV58103-GR	Gold Adaptor ring to suit HV5813, HV5842 Surface Mounted Downlight Models
HV5842-BLK-PDT	3M Pendant accessory to convert downlight into Pendant
HV5842-WHT-PDT	3M Pendant accessory to convert downlight into Pendant

See pages 295-306 for compatible drivers. All low voltage products that specify an input of 12v or 24v DC must be used with a suitable LED driver.



For detailed product specifications
 visit www.Havit.com.au
 or scan this QR code

HV5843S-BLK
HV5843S-BLK-12V



HV5843S-WHT
HV5843S-WHT-12V

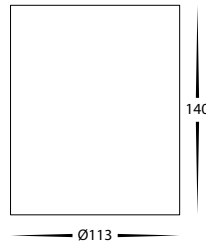

OPTIONAL GOLD ADAPTOR RINGS



Nella Aluminium

- Surface Mounted Round Downlight
- Aluminium Powder Coated Black or White
- Triac Dimmable (240V Model Only)
- 60° Beam Angle
- Supplied with Honeycomb Anti Glare Lens (can be removed)
- Optional Coloured Inserts
- IP Rating: IP54



PART NUMBER	COLOUR TEMP	LUMENS	INPUT	INCLUDED LED
HV5843S-BLK	2700K - 3000K - 4000K - 5000K - 5700K	1371lm - 1410lm- 1518lm- 1600lm- 1617lm	240V	Five-Colour Built in 18w LED
HV5843S-BLK-12V	2700K - 3000K - 4000K - 5000K - 5700K	1371lm- 1410lm- 1518lm- 1600lm- 1617lm	12V DC	Five-Colour Built in 18w LED
HV5843S-WHT	2700K - 3000K - 4000K - 5000K - 5700K	1371lm - 1410lm- 1518lm- 1600lm- 1617lm	240V	Five-Colour Built in 18w LED
HV5843S-WHT-12V	2700K - 3000K - 4000K - 5000K - 5700K	1371lm- 1410lm- 1518lm- 1600lm- 1617lm	12V DC	Five-Colour Built in 18w LED

HAVIT COMPATIBLE ACCESSORIES

HV5843-GR	Gold Insert to suit HV5843 Models
HV5843-CR	Chrome Insert to suit HV5843 Models
HV5843-BR	Black Insert to suit HV5843 Models
HV58101-GR	Gold Adaptor ring to suit HV5803, HV5815, HV5843 Surface Mounted Downlight Models
HV5843-BLK-PDT	3M Pendant accessory to convert downlight into Pendant
HV5843-WHT-PDT	3M Pendant accessory to convert downlight into Pendant

See pages 295-306 for compatible drivers. All low voltage products that specify an input of 12v or 24v DC must be used with a suitable LED driver.



Surface Mounted Downlights & Pendants

HV5844S-BLK
HV5844S-BLK-12V



HV5844S-WHT
HV5844S-WHT-12V

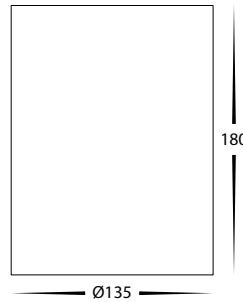

HV5844-GR



HV5844-CR



HV5844-BR



HV5843-BLK-PDT



HV5843-WHT-PDT



OPTIONAL GOLD ADAPTOR RINGS

HV58104-GR



Nella Aluminium

- Surface Mounted Round Downlight
- Aluminium Powder Coated Black or White
- Triac Dimmable (240V Model Only)
- 60° Beam Angle
- Supplied with Honeycomb Anti Glare Lens (can be removed)
- Optional Coloured Inserts
- IP Rating: IP54



PART NUMBER	COLOUR TEMP	LUMENS	INPUT	INCLUDED LED
HV5844S-BLK	2700K - 3000K - 4000K - 5000K - 5700K	1554lm- 1638lm- 1796lm- 1893lm- 1968lm	240V	Five-Colour Built in 24w LED
HV5844S-BLK-12V	2700K - 3000K - 4000K - 5000K - 5700K	1554lm- 1638lm- 1796lm- 1893lm- 1968lm	12V DC	Five-Colour Built in 24w LED
HV5844S-WHT	2700K - 3000K - 4000K - 5000K - 5700K	1554lm- 1638lm- 1796lm- 1893lm- 1968lm	240V	Five-Colour Built in 24w LED
HV5844S-WHT-12V	2700K - 3000K - 4000K - 5000K - 5700K	1554lm- 1638lm- 1796lm- 1893lm- 1968lm	12V DC	Five-Colour Built in 24w LED

HAVIT COMPATIBLE ACCESSORIES

HV5844-GR	Gold Insert to suit HV5843 Models
HV5844-CR	Chrome Insert to suit HV5843 Models
HV5844-BR	Black Insert to suit HV5843 Models
HV58104-GR	Gold Adaptor ring to suit HV5844 Surface Mounted Downlight Models
HV5844-BLK-PDT	3M Pendant accessory to convert downlight into Pendant
HV5844-WHT-PDT	3M Pendant accessory to convert downlight into Pendant

See pages 295-306 for compatible drivers. All low voltage products that specify an input of 12v or 24v DC must be used with a suitable LED driver.



For detailed product specifications
visit www.Havit.com.au
or scan this QR code

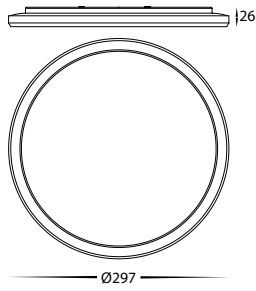

HV5877T-WHT

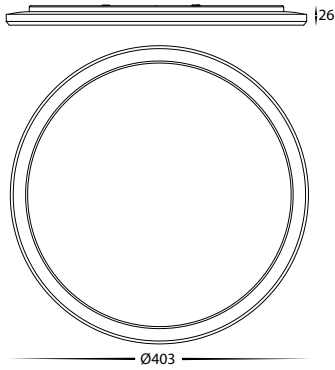

HV5878T-WHT

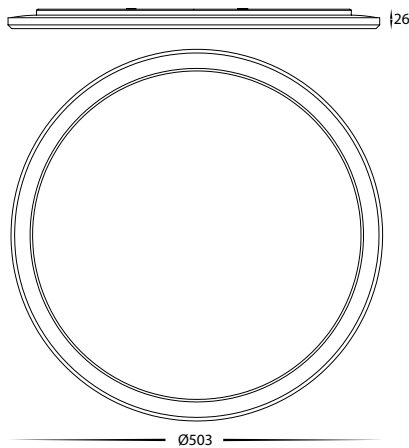

HV5879T-WHT



Slim White

- Slim oyster light
- Polycarbonate Body and Diffuser
- Triac Dimmable
- IP Rating: IP54

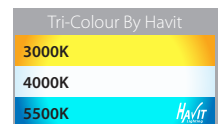

PART NUMBER	COLOUR TEMP	LUMENS	INPUT	INCLUDED LED
HV5877T-WHT	3000K - 4000K - 5500K	2000lm - 2100lm - 2200lm	240v	Tri-Colour Built-in 24w LED
HV5878T-WHT	3000K - 4000K - 5500K	2600lm - 2700lm - 2800lm	240v	Tri-Colour Built-in 30w LED
HV5879T-WHT	3000K - 4000K - 5500K	3600lm - 3700lm - 3800lm	240v	Tri-Colour Built-in 40w LED



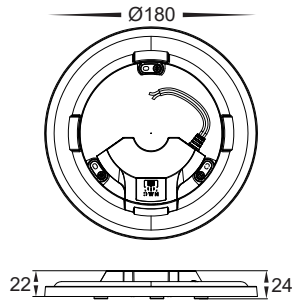

HV5881T

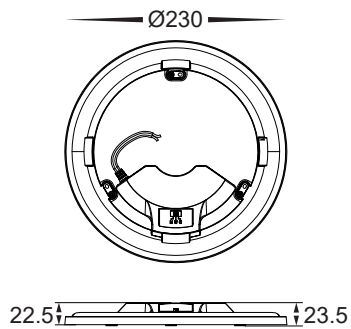

HV5882T

LED Panel Light

- Replaceable panel light
- Full plastic body
- Triac Dimmable
- Dual Wattage
- Male + female connector for ease of replacement
- Supplied with mounting screws and magnets for ease of installation
- IP Rating: IP20

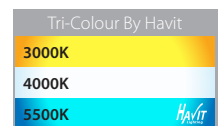

PART NUMBER	COLOUR TEMP	LUMENS	INPUT	INCLUDED LED
HV5881T	3000K - 4000K - 5500K	1340lm - 1685lm 1490lm - 1904lm 1455lm - 1830lm	240v	Tri Colour 12w-16w Built in LED
HV5882T	3000K - 4000K - 5500K	2380lm - 3220lm 2545lm - 3475lm 2530lm - 3430lm	240v	Tri Colour 18w-26w Built in LED



For detailed product specifications
visit www.Havit.com.au
or scan this QR code



HV5892T-BLK
Aluminium Black



HV5892T-WHT
Aluminium White

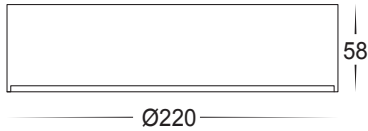

HV5893T-BLK
Aluminium Black



HV5893T-WHT
Aluminium White

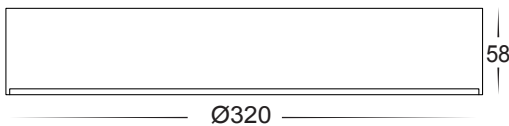

Nella Oyster Aluminium

- Surface mounted LED oyster
- Aluminium Powder Coated Black or White
- Triac Dimmable
- 120° beam angle
- IP Rating: IP54

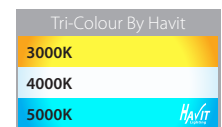

PART NUMBER	COLOUR TEMP	LUMENS	INPUT	INCLUDED LED
HV5892T-BLK	3000K - 4000K - 5500K	1210lm - 1345lm - 1250lm	240v	Tri-Colour Built-in 20w LED
HV5893T-BLK	3000K - 4000K - 5500K	2055lm - 2130lm - 2210lm	240v	Tri-Colour Built-in 30w LED
HV5892T-WHT	3000K - 4000K - 5500K	1210lm - 1345lm - 1250lm	240v	Tri-Colour Built-in 20w LED
HV5893T-WHT	3000K - 4000K - 5500K	2055lm - 2130lm - 2210lm	240v	Tri-Colour Built-in 30w LED



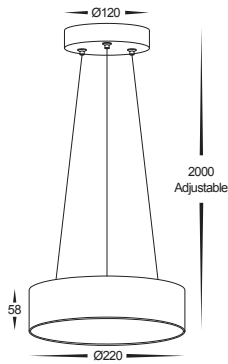

HV5892T-BLK-PDT
HV5892T-WHT-PDT

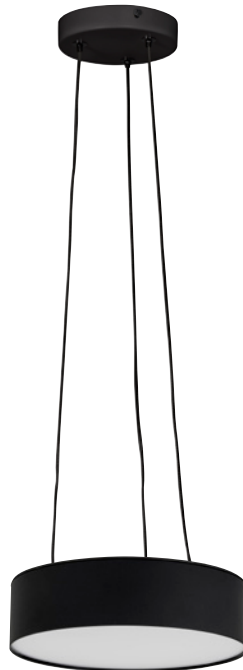

HV5892T-BLK-PDT
Aluminium Black



HV5892T-WHT-PDT
Aluminium White

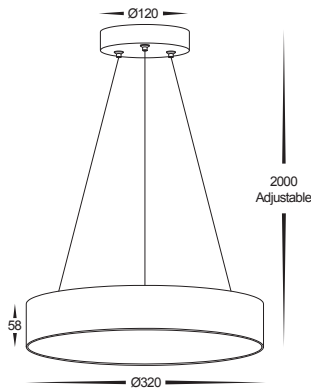

HV5893T-BLK-PDT
HV5893T-WHT-PDT

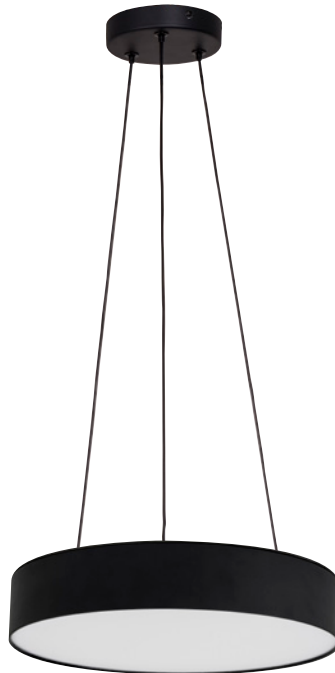

HV5893T-BLK-PDT
Aluminium Black

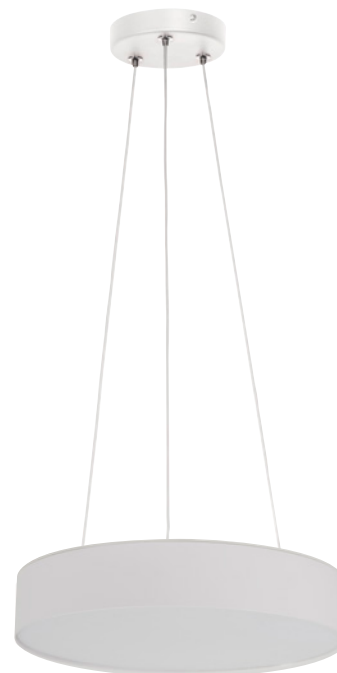

HV5893T-WHT-PDT
Aluminium White

Nella Pendant Aluminium

- LED Pendant
- Aluminium Powder Coated Black or White
- 2000mm Adjustable Cable Length
- Triac Dimmable
- Opal Polycarbonate Diffuser
- 120° Beam Angle
- IP Rating: IP20



PART NUMBER	COLOUR TEMP	LUMENS	INPUT	INCLUDED LED
HV5892T-BLK-PDT	3000K - 4000K - 5500K	1210lm - 1345lm - 1250lm	240v	Tri-Colour Built-in 20w LED
HV5893T-BLK-PDT	3000K - 4000K - 5500K	2055lm - 2130lm - 2210lm	240v	Tri-Colour Built-in 30w LED
HV5892T-WHT-PDT	3000K - 4000K - 5500K	1210lm - 1345lm - 1250lm	240v	Tri-Colour Built-in 20w LED
HV5893T-WHT-PDT	3000K - 4000K - 5500K	2055lm - 2130lm - 2210lm	240v	Tri-Colour Built-in 30w LED



For detailed product specifications
visit www.Havit.com.au
or scan this QR code



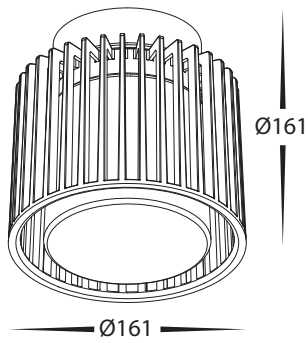

HV5894W-BLK

Lumo Aluminium

- LED Ceiling Light
- Aluminium Poly Powder Coated Black
- Dimmable
- IP Rating: IP54
- IK Rating: IK04



PART NUMBER	COLOUR TEMP	LUMENS	INPUT	INCLUDED LED
HV5894W-BLK	2700k	700lm	240V	9w E27 LED Filament Globe



For detailed product specifications
visit www.Havit.com.au
or scan this QR code



HV5898T-BLK
Aluminium Black



HV5898T-WHT
Aluminium White

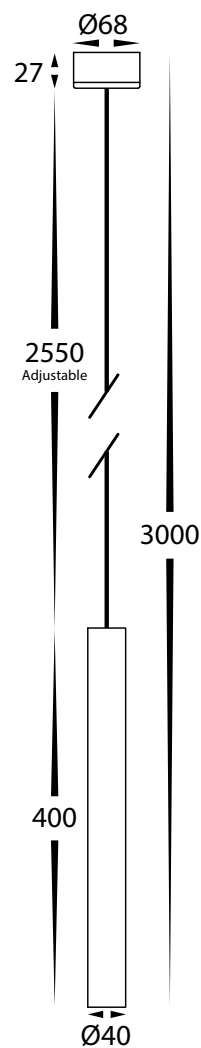

Henger

- Cylinder Pendant Light
- Aluminium Black or White
- Adjustable 2500mm Cable Length
- Triac Dimmable
- IP Rating: IP65

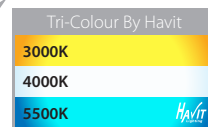

PART NUMBER	COLOUR TEMP	LUMENS	INPUT	INCLUDED LED
HV5898T-BLK	3000K - 4000K - 5500K	480lm - 520lm - 500lm	240V	Tri Colour Built in 6w LED
HV5898T-WHT	3000K - 4000K - 5500K	480lm - 520lm - 500lm	240V	Tri Colour Built in 6w LED





HV5899T-BLK
Aluminium Black



HV5899T-WHT
Aluminium White

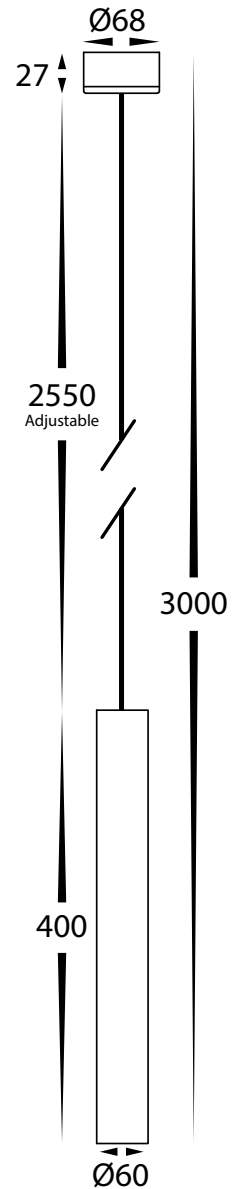

Henger

- Cylinder Pendant Light
- Aluminium Black or White
- Adjustable 2500mm Cable Length
- Triac Dimmable
- IP Rating: IP65

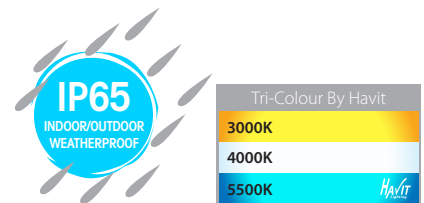

PART NUMBER	COLOUR TEMP	LUMENS	INPUT	INCLUDED LED
HV5899T-BLK	3000K - 4000K - 5500K	720lm - 760lm - 740lm	240V	Tri Colour Built in 9w LED
HV5899T-WHT	3000K - 4000K - 5500K	720lm - 760lm - 740lm	240V	Tri Colour Built in 9w LED



For detailed product specifications
visit www.Havit.com.au
or scan this QR code



HV5901T-AB-240V
HV5901T-AB-12V
 Antique Brass

HV5901T-BLK-240V
HV5901T-BLK-12V
 Black Brass

HV5901T-BR-240V
HV5901T-BR-12V
 Solid Brass

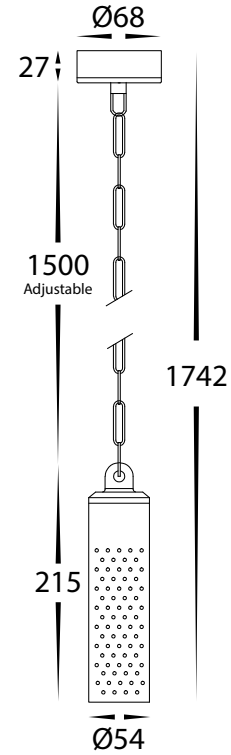

Willow

- Cylinder Pendant Light
- Solid Brass, Solid Brass with Antique Brass Finish, Solid Brass Poly Powder Coated Black
- Adjustable 1500mm Cable Length
- IP Rating: IP65

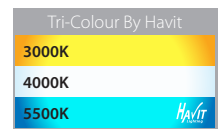

PART NUMBER	COLOUR TEMP	LUMENS	INPUT	INCLUDED LED
HV5901T-AB-240V	3000K - 4000K - 5500K	270lm - 285lm - 300lm	240V	Tri Colour 5w GU10
HV5901T-BLK-240V	3000K - 4000K - 5500K	270lm - 285lm - 300lm	240V	Tri Colour 5w GU10
HV5901T-BR-240V	3000K - 4000K - 5500K	270lm - 285lm - 300lm	240V	Tri Colour 5w GU10
HV5901T-AB-12V	3000K - 4000K - 5500K	270lm - 285lm - 300lm	12v DC	Tri Colour 5w MR16
HV5901T-BLK-12V	3000K - 4000K - 5500K	270lm - 285lm - 300lm	12v DC	Tri Colour 5w MR16
HV5901T-BR-12V	3000K - 4000K - 5500K	270lm - 285lm - 300lm	12v DC	Tri Colour 5w MR16





HV5902T-AB-240V
HV5902T-AB-12V
Antique Brass

HV5902T-BLK-240V
HV5902T-BLK-12V
Black Brass

HV5902T-BR-240V
HV5902T-BR-12V
Solid Brass

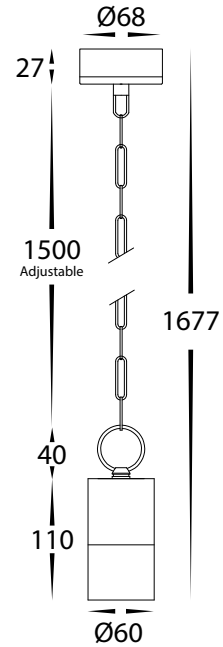

Tivah

- Cylinder Pendant Light
- Solid Brass, Solid Brass with Antique Brass Finish, Solid Brass Poly Powder Coated Black
- Adjustable 1500mm Cable Length
- IP Rating: IP65

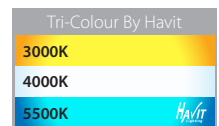

PART NUMBER	COLOUR TEMP	LUMENS	INPUT	INCLUDED LED
HV5902T-AB-240V	3000K - 4000K - 5500K	270lm - 285lm - 300lm	240V	Tri Colour 5w GU10
HV5902T-BLK-240V	3000K - 4000K - 5500K	270lm - 285lm - 300lm	240V	Tri Colour 5w GU10
HV5902T-BR-240V	3000K - 4000K - 5500K	270lm - 285lm - 300lm	240V	Tri Colour 5w GU10
HV5902T-AB-12V	3000K - 4000K - 5500K	270lm - 285lm - 300lm	12v DC	Tri Colour 5w MR16
HV5902T-BLK-12V	3000K - 4000K - 5500K	270lm - 285lm - 300lm	12v DC	Tri Colour 5w MR16
HV5902T-BR-12V	3000K - 4000K - 5500K	270lm - 285lm - 300lm	12v DC	Tri Colour 5w MR16



For detailed product specifications
 visit www.Havit.com.au
 or scan this QR code



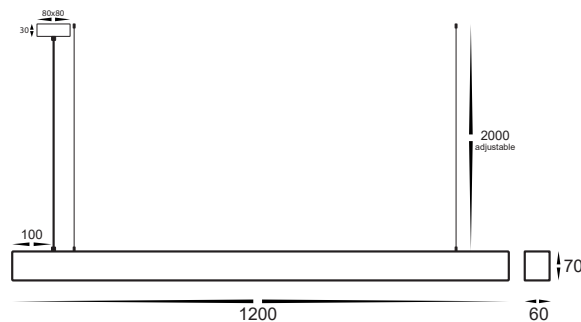
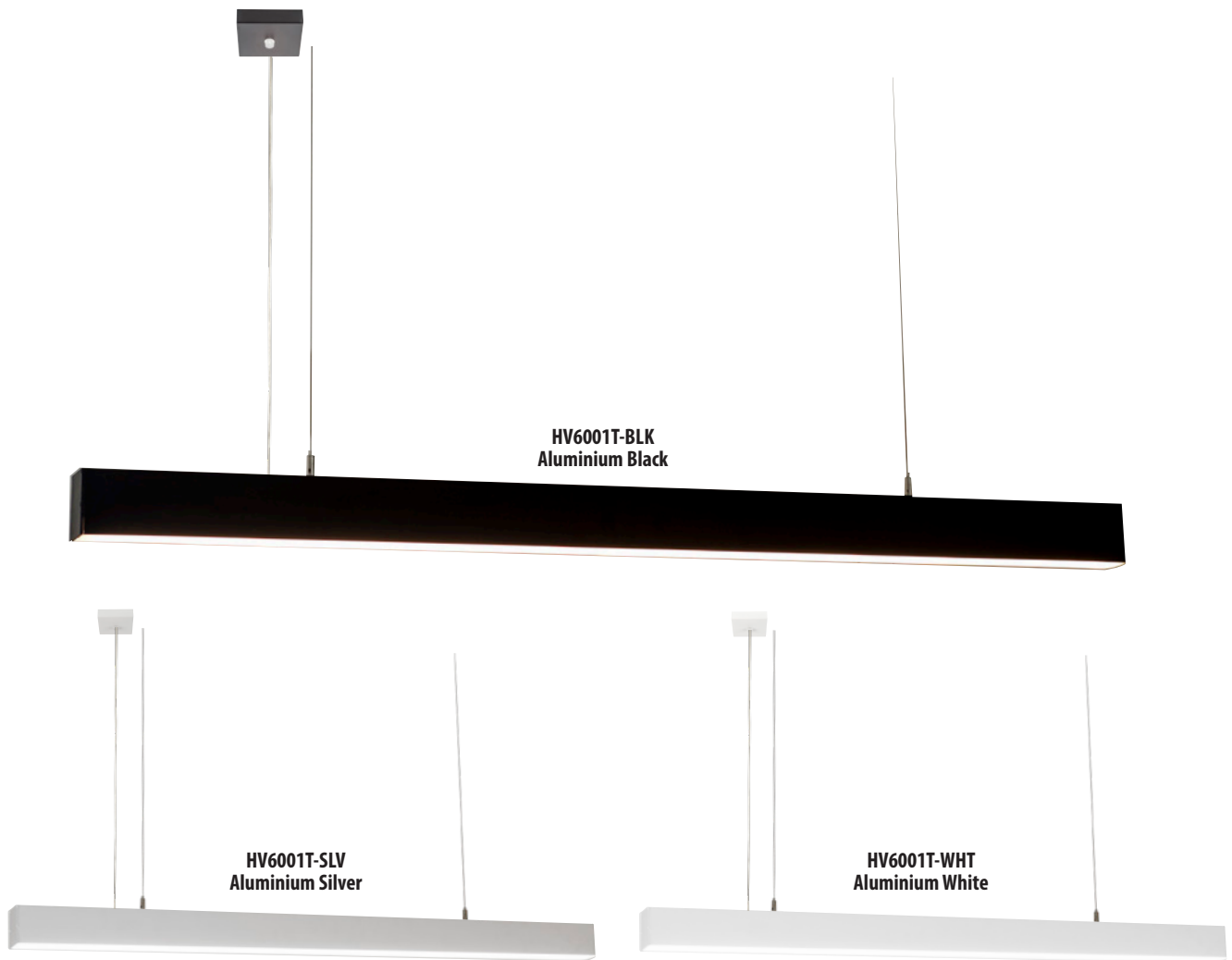

Proline

- Single pendant light
- Aluminium Black, White or Silver finish
- Triac Dimmable
- 120° beam angle
- Cable length: 2000mm Adjustable
- IP Rating: IP20
- Indoor use only

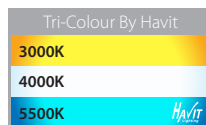

For custom size lengths please contact sales representative for more information.

PART NUMBER	COLOUR TEMP	LUMENS	INPUT	INCLUDED LED
HV6001T-BLK	3000K - 4000K - 5500K	3800lm - 3900lm - 4000lm	240v	Tri-Colour Built-in 40w LED
HV6001T-SLV	3000K - 4000K - 5500K	3800lm - 3900lm - 4000lm	240v	Tri-Colour Built-in 40w LED
HV6001T-WHT	3000K - 4000K - 5500K	3800lm - 3900lm - 4000lm	240v	Tri-Colour Built-in 40w LED



For detailed product specifications visit www.Havit.com.au or scan this QR code

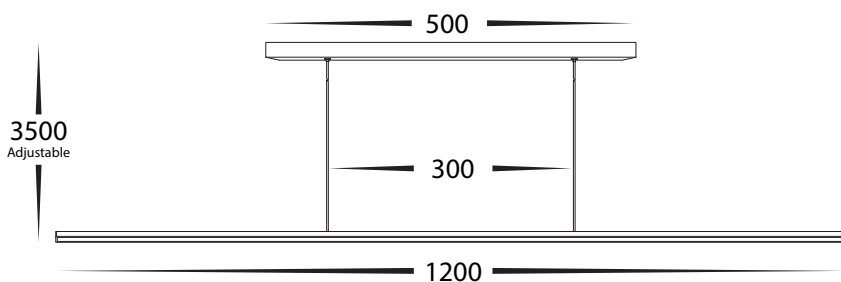
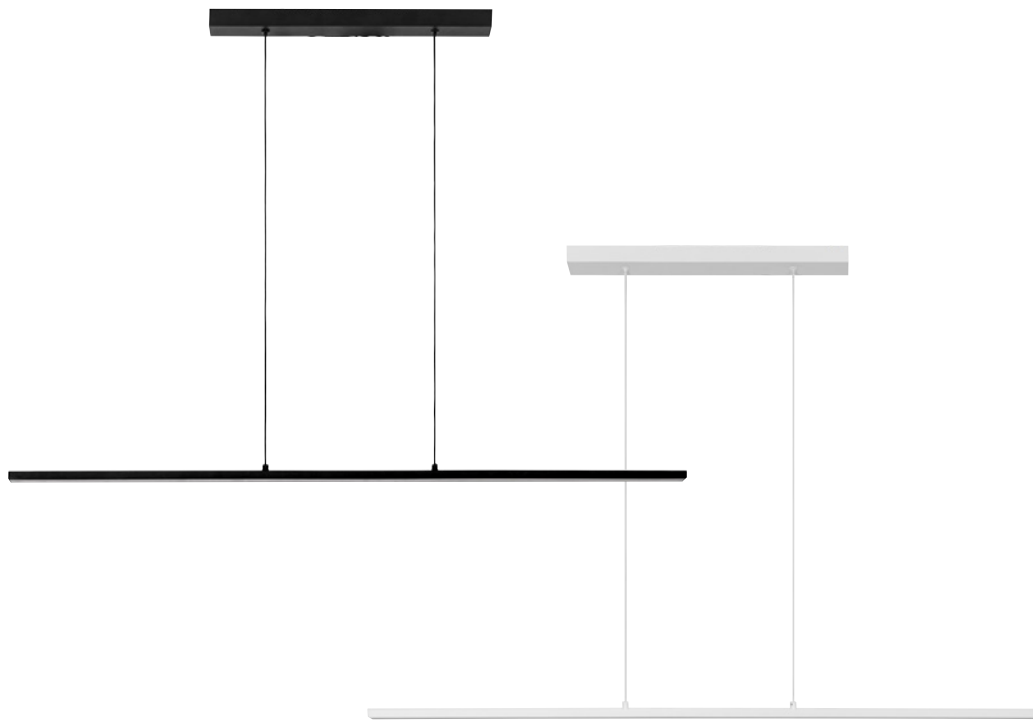

Proline Aluminium

- LED Pendant Light
- Aluminium Powder Coated Black or White
- Triac Dimmable
- 3500mm Adjustable Length
- IP Rating: IP20



PART NUMBER	COLOUR TEMP	LUMENS	INPUT	INCLUDED LED
HV6005T-BLK	3000K - 4000K - 5500K	3000lm - 3270lm - 3440lm	240V	Tri Colour 40w Built in LED
HV6005T-WHT	3000K - 4000K - 5500K	3000lm - 3270lm - 3440lm	240V	Tri Colour 40w Built in LED



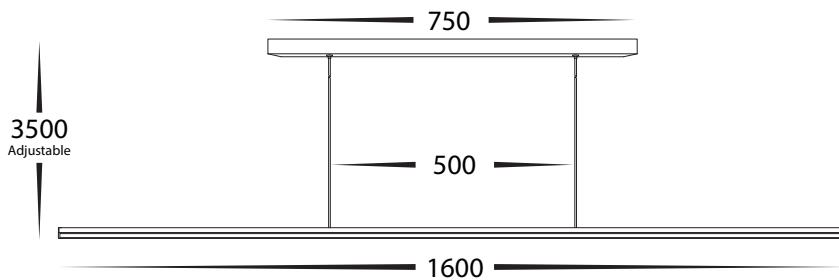
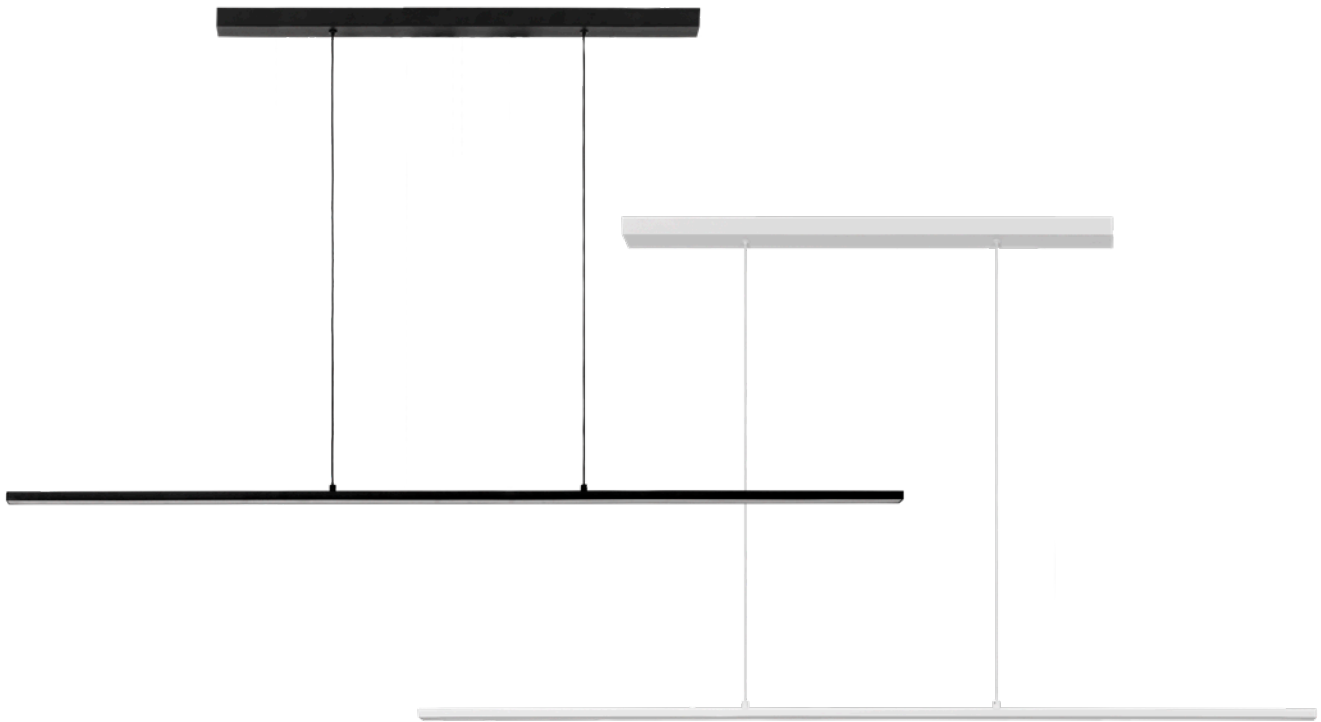

Proline Aluminium

- LED Pendant Light
- Aluminium Powder Coated Black or White
- Triac Dimmable
- 3500mm Adjustable Length
- IP Rating: IP20

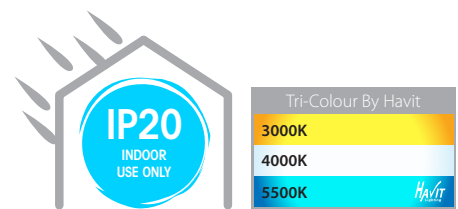

PART NUMBER	COLOUR TEMP	LUMENS	INPUT	INCLUDED LED
HV6006T-BLK	3000K - 4000K - 5500K	3750lm - 4080lm - 4300lm	240V	Tri Colour 50w Built in LED
HV6006T-WHT	3000K - 4000K - 5500K	3750lm - 4080lm - 4300lm	240V	Tri Colour 50w Built in LED



For detailed product specifications
visit www.Havit.com.au
or scan this QR code

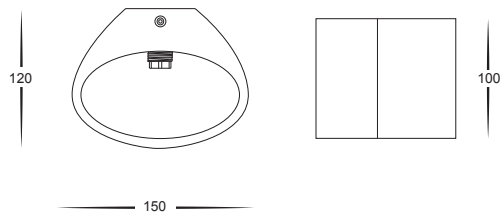

Arc

- High density extra strong plaster
- Super bright white
- Easily painted to match decor
- IP Rating: IP20
- Indoor use only



PART NUMBER	COLOUR TEMP	LUMENS	INPUT	INCLUDED LED
HV8025C	5500K	130lm	240v	2w COB G9
HV8025W	3000K	120lm	240v	2w COB G9

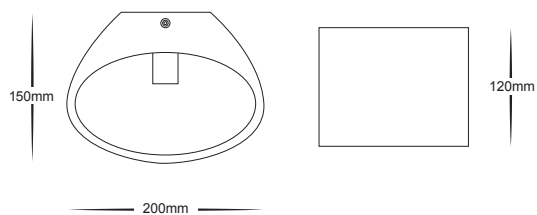

Arc

- High density extra strong plaster
- Super bright white
- Easily painted to match decor
- IP Rating: IP20
- Indoor use only



PART NUMBER	COLOUR TEMP	LUMENS	INPUT	INCLUDED LED
HV8026C	5500K	240lm	240v	3w SMD E14
HV8026W	3000K	220lm	240v	3w SMD E14



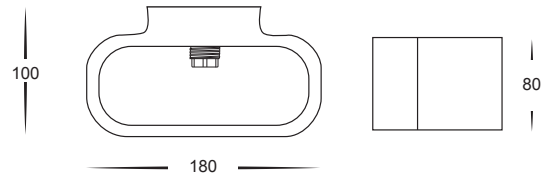

Concept

- High density extra strong plaster
- Super bright white
- Easily painted to match decor
- IP Rating: IP20
- Indoor use only



PART NUMBER	COLOUR TEMP	LUMENS	INPUT	INCLUDED LED
HV8027C	5500K	130lm	240v	2w COB G9
HV8027W	3000K	120lm	240v	2w COB G9

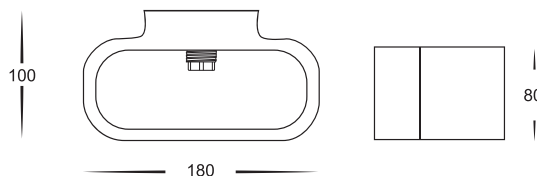

Concept

- Aluminium black or White with gold insert
- IP Rating: IP20
- Indoor use only



PART NUMBER	COLOUR TEMP	LUMENS	INPUT	INCLUDED LED
HV8028C-BLK	5500K	130lm	240v	2w G9 LED
HV8028W-BLK	3000K	120lm	240v	2w G9 LED
HV8028C-WHT	5500K	130lm	240v	2w COB G9
HV8028W-WHT	3000K	120lm	240v	2w COB G9



For detailed product specifications
visit www.Havit.com.au
or scan this QR code

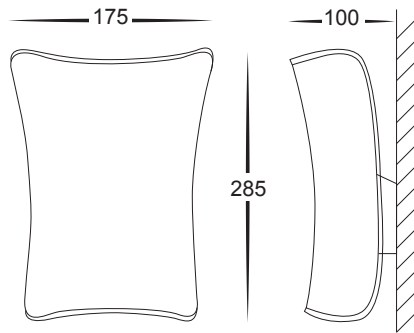

Aurora

- High density extra strong plaster
- Super bright white
- Easily painted to match decor
- IP Rating: IP20
- Indoor use only

PART NUMBER	COLOUR TEMP	LUMENS	INPUT	INCLUDED LED
HV8030C	5500K	240lm	240v	3w SMD E14
HV8030W	3000K	220lm	240v	3w SMD E14



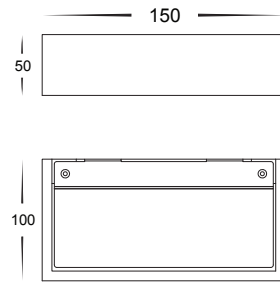

Sunrise 150

- High density extra strong plaster
- Super bright white
- Easily painted to match decor
- IP Rating: IP20
- Indoor use only

PART NUMBER	COLOUR TEMP	LUMENS	INPUT	INCLUDED LED
HV8069C	5500K	130lm	240v	2w G9 LED
HV8069W	3000K	120lm	240v	2w G9 LED

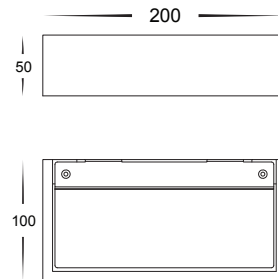

Sunrise 200

- High density extra strong plaster
- Super bright white
- Easily painted to match decor
- IP Rating: IP20
- Indoor use only

PART NUMBER	COLOUR TEMP	LUMENS	INPUT	INCLUDED LED
HV8070C	5500K	240lm	240v	3w SMD E14
HV8070W	3000K	220lm	240v	3w SMD E14



For detailed product specifications
visit www.Havit.com.au
or scan this QR code

**Zigbee Wireless Wall Switch
HV9101-ZB-5C**

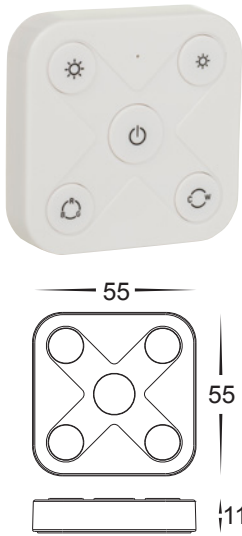

**Single Coloured Zigbee
LED Touch Panel
HV9101-ZB-SCTP**



**RGBW Zigbee
LED Touch Panel
HV9101-ZB-RGBWTP**

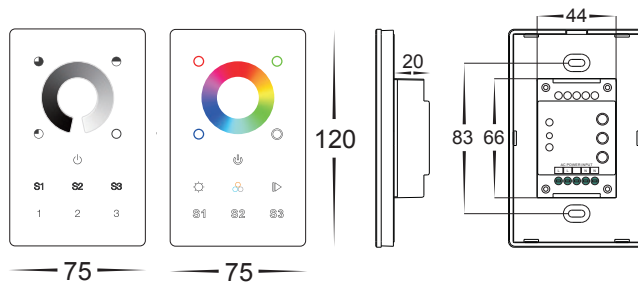
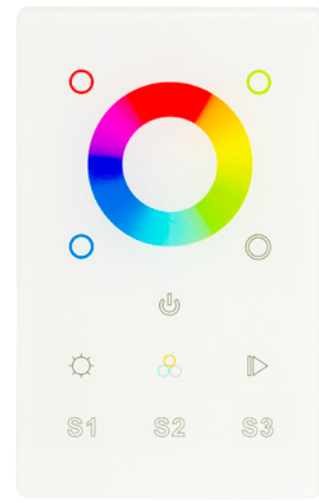

PART NUMBER	DESCRIPTION	POWER
HV9101-ZB-5C	<ul style="list-style-type: none"> • Zigbee LED Dimming Controller • Input Voltage: 3v DC • Dimming range: 0.1-100% • Operation Frequency: 2.4GHZ • Compatible with all Zigbee Receivers • Supplied with magnetic wall mount • Must be used with HV9105-ZB-5C 	3v DC Battery (CR2430)
HV9101-ZB-SCTP	<ul style="list-style-type: none"> • Single Coloured Zigbee LED Touch Panel • Compatible with Zigbee Receivers • Input Voltage: 240 AC • Preset 25% 50% 75% 100% brightness • Six Scenes • Dimming range: 0.1-100% • Operation Frequency: 2.4GHZ • Must be used with HV9105-ZB-5C 	240v
HV9101-ZB-RGBWTP	<ul style="list-style-type: none"> • RGBW Zigbee LED Touch Panel • Compatible with Zigbee Receivers • Three scenes • Input Voltage: 240v AC • Operation Frequency: 2.4GHZ • Must be used with HV9105-ZB-5C 	240v
HAVIT COMPATIBLE ACCESSORIES		
HV9105-ZB-5C	<ul style="list-style-type: none"> • Zigbee LED Strip Receiver • Can be used with Zigbee Hub, Zigbee Touch Panels or Remote Controllers • Can be used with all LED Strip • Input Voltage: 12-24v DC • Output Power: 5ch x 4A (240w-480w) • Operation Frequency 2.4GHZ 	12-24V DC



**Single Coloured Zigbee
LED Remote Control
HV9102-ZB-SCREM**



**RGBW Zigbee
LED Remote Control
HV9102-ZB-RGBWREM**

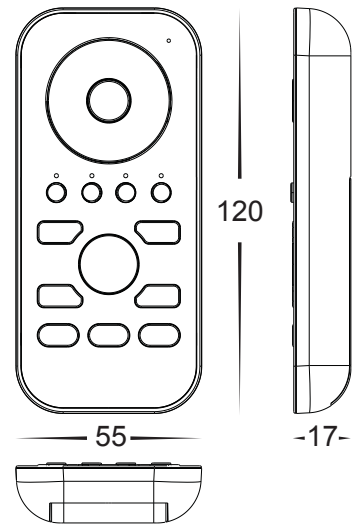

PART NUMBER	DESCRIPTION	POWER
HV9102-ZB-SCREM	<ul style="list-style-type: none"> • Single Coloured Zigbee LED Remote Controller • 4 zones + 3 scenes • Compatible with Zigbee Receivers • Input Voltage: 4.5v DC (3x AAA) • Operation Frequency: 2.4GHZ • Must be used with HV9105-ZB-5C 	4.5v 3x AAA Batteries Required
HV9102-ZB-RGBWREM	<ul style="list-style-type: none"> • RGBW Zigbee LED Remote Controller • Compatible with Zigbee Receivers • 4 zones + 3 scenes • Input Voltage: 4.5v DC (3x AAA) • Operation Frequency: 2.4GHZ • Must be used with HV9105-ZB-5C 	4.5v 3x AAA Batteries Required
HAVIT COMPATIBLE ACCESSORIES		
HV9105-ZB-5C	<ul style="list-style-type: none"> • Zigbee LED Strip Receiver • Can be used with Zigbee Hub, Zigbee Touch Panels or Remote Controllers • Can be used with all LED Strip • Input Voltage: 12-24v DC • Output Power: 5ch x 4A (240w-480w) • Operation Frequency 2.4GHZ 	12-24V DC



For detailed product specifications
visit www.Havit.com.au
or scan this QR code



**TRAILING EDGE DIMMER
HV9105-ZB-ACDIM**



**ON-OFF SWITCH
HV9105-ZB-ACSW**

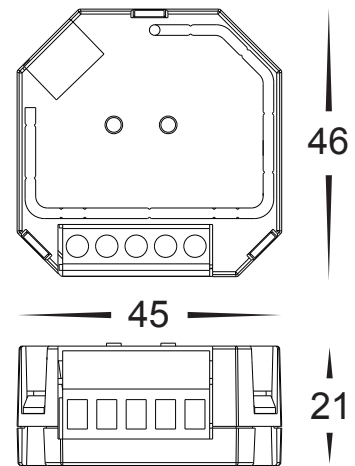

Zigbee Relays



PART NUMBER	DESCRIPTION	POWER
HV9105-ZB-ACDIM	<ul style="list-style-type: none"> • Zigbee Trailing edge dimmer • Can be controlled using HV9101-ZB-5C • Can be used with push dimmer • Can be used with Zigbee Hub • Input Voltage: 240v AC • Output Power: 400W (200w LED) • Operation frequency 2.4GHZ • Dimming Range - 5-100% 	240v
HV9105-ZB-ACSW	<ul style="list-style-type: none"> • Zigbee on-off switch • Can be controlled using HV9101-ZB-5C • Can be used with push switch • Can be used with Zigbee Hub • Input Voltage: 240v AC • Output Power: 400W (200w LED) • Operation frequency 2.4GHZ 	240v





**UNIVERSAL
HV9105-ZB-5C**

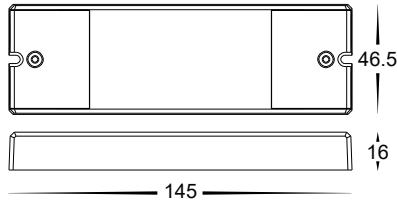

**Universal
HV9105-1009-5C**

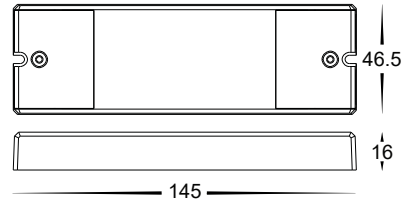

Zigbee Receiver & LED Strip WIFI Receivers

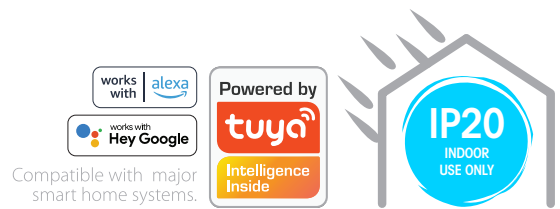

PART NUMBER	DESCRIPTION	POWER
HV9105-ZB-5C	<ul style="list-style-type: none"> • Zigbee LED Strip Receiver • Can be used with Zigbee Hub, Zigbee Touch Panels or Remote Controllers • Can be used with all LED Strip • Input Voltage: 12-24v DC • Output Power: 5ch x 4A (240w-480w) • Operation Frequency 2.4GHZ 	12-24V DC
HV9105-1009-5C	<ul style="list-style-type: none"> • Universal RF + WIFI LED Strip Receiver • For use with all LED Strip • Can be used with RF Remote or APP • Input Votage: 12v or 24v DC • IP Rating: IP20 	12v DC 240w 24v DC 480w



For detailed product specifications
visit www.Havit.com.au
or scan this QR code



SINGLE COLOUR
HV9102-2819DIM



CCT
HV9102-2819CCT



RGBC & RGBW
HV9102-2819RGBW

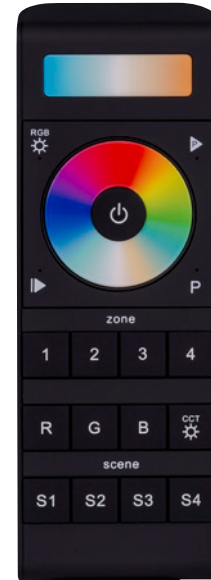

RGBCW
HV9102-2858Z4-5C

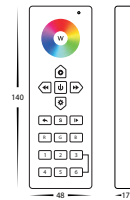
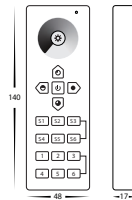

RF LED Remote Controls

PART NUMBER	DESCRIPTION	POWER
HV9102-2819DIM	<ul style="list-style-type: none"> • Single Colour LED Strip Controller • 4.5v (3xAAA Batteries) • Approx. 30m Range • 6x Zones • 6x Scenes • IP20 • Must be used with HV9105-1009-5C 	4.5v 3x AAA Batteries Required
HV9102-2819CCT	<ul style="list-style-type: none"> • CCT LED Strip Controller • 4.5v (3x AAA Batteries) • Approx 30m range • IP20 • Must be used with HV9105-1009-5C 	4.5v 3x AAA Batteries Required
HV9102-2819RGBW	<ul style="list-style-type: none"> • RGBC or RGBW LED Strip Controller • 4.5v (3xAAA Batteries) • Approx. 30m Range • 6x Zones • IP20 • Must be used with HV9105-1009-5C 	4.5v 3x AAA Batteries Required
HV9102-2858Z4-5C	<ul style="list-style-type: none"> • RGBCW LED Strip Controller • 4.5v (3xAAA Batteries) • Approx. 30m Range • 4x Zones • 4x Scenes • IP20 • Must be used with HV9105-1009-5C 	4.5v 3x AAA Batteries Required
HAVIT COMPATIBLE ACCESSORIES		
HV9105-1009-5C	<ul style="list-style-type: none"> • RF + WIFI LED Strip Receiver • For use with all LED Strip • Can be used with RF Remote or APP • Input Votage: 12v or 24v DC 	12v DC 240w 24v DC 480w max



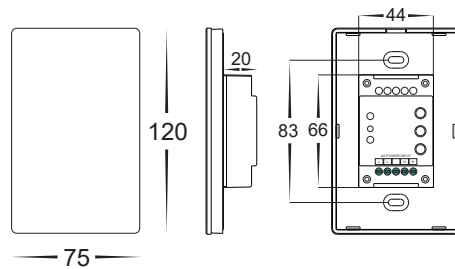

RF LED Strip Touch Panel

PART NUMBER	DESCRIPTION	POWER
HV9101-2830A	<ul style="list-style-type: none"> RF LED Strip Touch Panel For use with Single Colour LED Strip Input Voltage: 240v AC 4 Zones 4 Scenes IP20 Must be used with HV9105-1009-5C 	240v
HV9101-2830B	<ul style="list-style-type: none"> For use with CT LED Strip Input Voltage: 240v IP20 Must be used with HV9105-1009-5C 	240v
HV9101-2820	<ul style="list-style-type: none"> RF LED Strip Touch Panel For use with RGBC or RGBW LED Strip Input Voltage: 240v AC 3 Zones IP20 Must be used with HV9105-1009-5C 	240v
HV9101-2834-5C	<ul style="list-style-type: none"> For use with RGBCW LED Strip Input Voltage: 240v IP20 Must be used with HV9105-1009-5C 	240v
HAVIT COMPATIBLE ACCESSORIES		
HV9105-1009-5C	<ul style="list-style-type: none"> RF + WIFI LED Strip Receiver For use with all LED Strip Can be used with RF Remote or APP Input Voltage: 12v or 24v DC 	12v DC 240w 24v DC 480w max



For detailed product specifications
visit www.Havit.com.au
or scan this QR code



**Single Colour
HV9102-M1+M4-5A**



**Colour Temp (CT) 3000K-5500K
HV9102-M2+M4-5A**

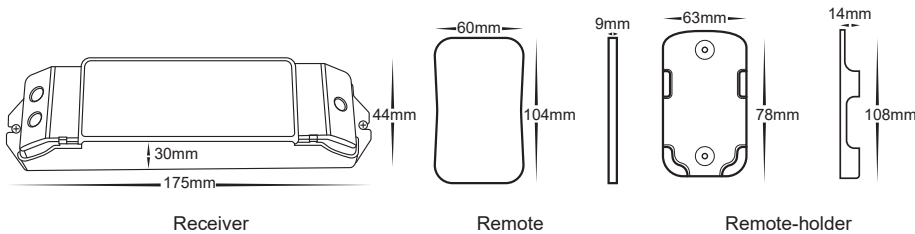

LED Strip Remote Controllers

PART NUMBER	DESCRIPTION	POWER
HV9102-M1+M4-5A	<ul style="list-style-type: none"> • Single colour remote controller and receiver • 3v Battery (CR2032) • Output signal: 2.4ghz • Transmitting range: 30m approx • Input Voltage: 12v DC or 24v DC • Dimming Range 5-100% 	12v DC 240w 24v DC 480w
HV9102-M2+M4-5A	<ul style="list-style-type: none"> • CT remote controller and receiver • 3v Battery (CR2032) • Output signal: 2.4ghz • Transmitting range: 30m approx • Input Voltage: 12v DC or 24v DC • Dimming Range 5-100% 	12v DC 240w 24v DC 480w





RGB
HV9102-M3+M4-5A



RGBC & RGBW
HV9102-M4+M4-5A

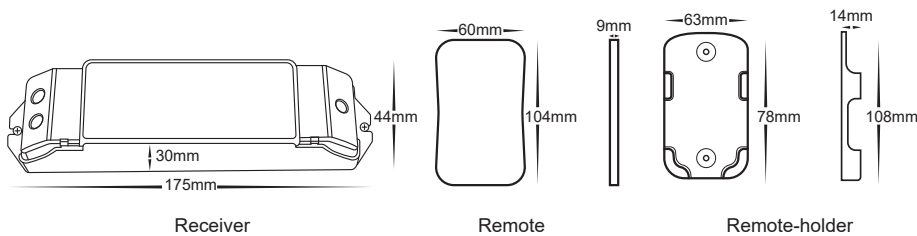

LED Strip Remote Controllers

PART NUMBER	DESCRIPTION	POWER
HV9102-M3+M4-5A	<ul style="list-style-type: none"> • RGB remote controller and receiver • 3v Battery (CR2032) • Output signal: 2.4ghz • Transmitting range: 30m approx • Input Voltage: 12v DC or 24v DC • Adjustable speed and brightness 	<p>12v DC 180w 24v DC 360w</p>
HV9102-M4+M4-5A	<ul style="list-style-type: none"> • RGBC or RGBW remote controller and receiver • 3v Battery (CR2032) • Output signal: 2.4ghz • Transmitting range: 30m approx • Input Voltage: 12v DC or 24v DC • Adjustable speed and brightness 	<p>12v DC 240w 24v DC 480w</p>



For detailed product specifications
visit www.Havit.com.au
or scan this QR code

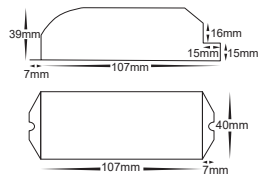

**0-1/10v RGB Controller
HV9106-LT-393-5A**



**0-1/10v Single Colour Controller
HV9106-LT-701-12A**



**0-1/10v RGBC & RGBW Controller
HV9106-LT-704-5A**



**Dali Single Colour Controller
HV9107-LT-401-12A**



**Dali RGBC & RGBW Controller
HV9107-LT-404-5A**



0-1/10v LED Strip Controllers

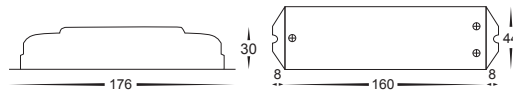

PART NUMBER	DESCRIPTION	POWER
HV9106-LT-393-5A	<ul style="list-style-type: none"> • RGB • 0-1/10v RGB LED Strip Controller • Input Signal: 0-1/10v • Input Voltage: 12v DC or 24v DC 	<p>12v DC 180w 24v DC 360w</p>
HV9106-LT-701-12A	<ul style="list-style-type: none"> • Single Colour • 0-1/10v LED Strip Controller • Dimming range: 0-100% • Input Signal: 0-1/10v • Input Voltage: 12v DC or 24v DC 	<p>12v DC 144w 24v DC 288w</p>
HV9106-LT-704-5A	<ul style="list-style-type: none"> • RGBC & RGBW • 0-1/10v RGBC & RGBW LED Strip Controller • Input Signal: 0-1/10v • Input Voltage: 12v DC or 24v DC 	<p>12v DC 240w 24v DC 480w</p>

Dali LED Strip Controllers

PART NUMBER	DESCRIPTION	POWER
HV9107-LT-401-12A	<ul style="list-style-type: none"> • Single Colour • Dali LED Strip Controller • Dimming range: 0-100% • Input Signal: DALI digital dimming signal • Input Voltage: 12v DC or 24v DC • Output Signal: 0-1/10v 	<p>12v DC 144w 24v DC 288w</p>
HV9107-LT-404-5A	<ul style="list-style-type: none"> • RGBC & RGBW • Dali RGBC/RGBW LED Strip Controller • Input Signal: DALI digital dimming signal • Input Voltage: 12v DC or 24v DC • Output Signal: 0-1/10v 	<p>12v DC 216w 24v DC 432w</p>





**Dali DT8 LED Strip Controller
HV9107-2309P-5C**

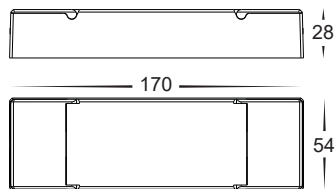

**DMX Single Colour Controller
HV9109-LT-811-12A**



**DMX RGB Controller
HV9109-LT-823-6A**



**DMX RGBC & RGBW Controller
HV9109-LT-820-5A**



**DMX RGBCW Controller
HV9103-F5-DMX-4A**



DALI DT8 Controller

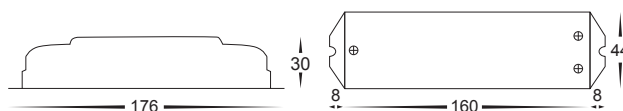

PART NUMBER	DESCRIPTION	POWER
HV9107-2309P-5C	<ul style="list-style-type: none"> Dali DT8 LED strip controller Built-in DALI-2 interface, DALI DT8 device 5 Channels constant voltage output Input voltage: 12v DC or 24v DC 	<p>12v DC 300w 24v DC 600w</p>

DMX LED Strip Controller

PART NUMBER	DESCRIPTION	POWER
HV9109-LT-811-12A	<ul style="list-style-type: none"> DMX LED strip controller For use with Single Colour LED strip Input signal: DMX512 Input voltage: 12v DC or 24v DC Max Load Current: 12A x 1CH + 0-10V X 1CH + 10V PWM X 1CH Dimming Range: 0-100% 	<p>12v DC 144w 24v DC 288w</p>
HV9109-LT-823-6A	<ul style="list-style-type: none"> DMX LED strip controller For use with RGB LED strip Input signal: DMX512 Input voltage: 12v DC or 24v DC Max Load Current: 6A X 3 Channel Max 18A Dimming Range: 0-100% 	<p>12v DC 216w 24v DC 432w</p>
HV9109-LT-820-5A	<ul style="list-style-type: none"> DMX LED strip controller For use with RGBC or RGBW LED strip Input signal: DMX512 Input voltage: 12v DC or 24v DC Max Load Current: 5A X 4 Channel Max 20A Dimming Range: 0-100% 	<p>12v DC 240w 24v DC 480w</p>
HV9103-F5-DMX-4A	<ul style="list-style-type: none"> Zone receiving controller 5 Channel Input Voltage: 12v DC or 24v DC Frequency: 2.4GHZ 	<p>12v DC 240w 24v DC 480w</p>



For detailed product specifications
visit www.Havit.com.au
or scan this QR code

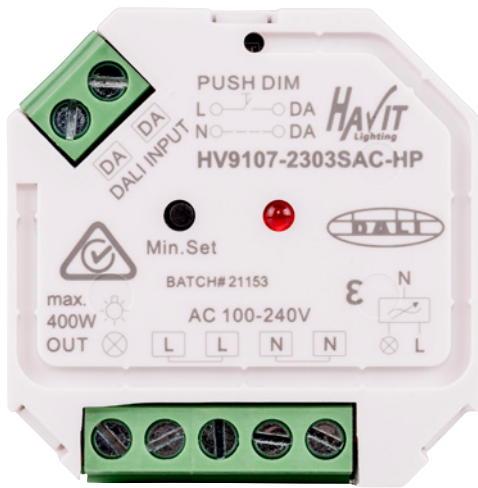

Dimming Relay
HV9107-2303SAC-HP

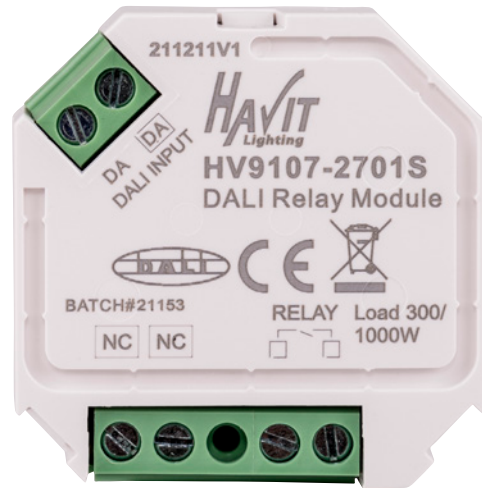

On/Off Relay
HV9107-2701S

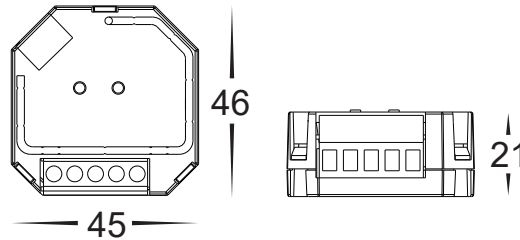

Dali Relay Modules

PART NUMBER	DESCRIPTION	POWER
HV9107-2303SAC-HP	<ul style="list-style-type: none"> • Dali Relay Module • Dimmer Relay • To make non DALI fittings DALI Compatible • IP Rating: IP20 • Dimming Range 0-100% • Input voltage: 240V • No. of addresses: 1 • Max Output Power: 200w LED 	240v
HV9107-2701S	<ul style="list-style-type: none"> • Dali Relay Module • On and Off Relay • To make non DALI fittings DALI Compatible • IP Rating: IP20 • Input voltage: 240V • No. of addresses: 1 • Max Output Power: 200w LED 	240v



**LED Dial Dimmer
HV9625**

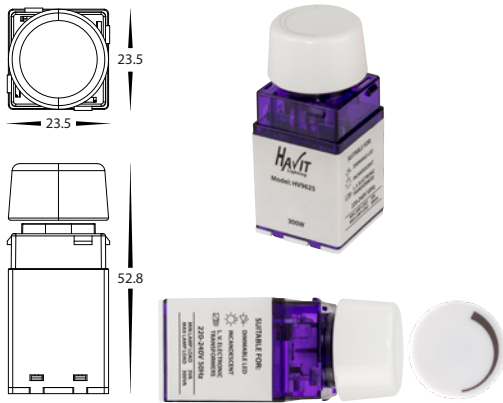

**5 Channel LED Repeater
HV9636**

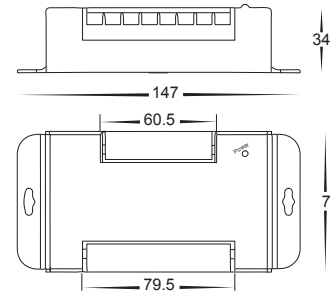
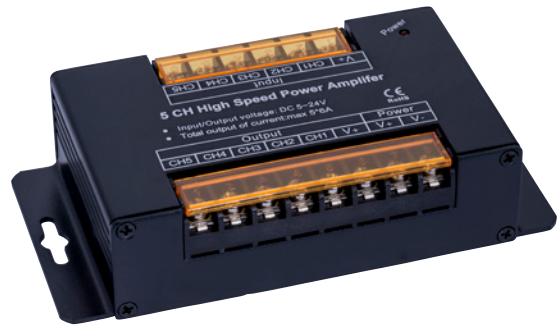

**1-10v LED Strip Dimming Pot
HV9629**

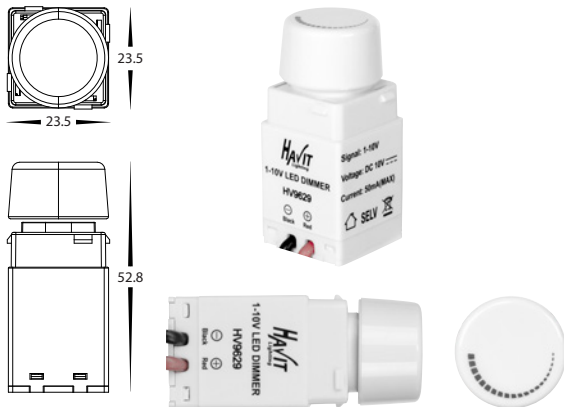

PART NUMBER	DESCRIPTION	POWER
HV9625	<ul style="list-style-type: none"> LED Dial Dimmer Suits specified Havit dimmable products 3-300w Max Input voltage: 240v 	240v
HV9629	<ul style="list-style-type: none"> 1-10v LED Strip Dimming Pot 1-10v dimming pot for Clipsal or HPM plate Enables wall plate dimming on a standard Clipsal or HPM plate To be used with HV9661 model drivers or HV9106-LT-701-12A 	NA
HV9636	<ul style="list-style-type: none"> 5 Channel LED Strip Repeater Enables additional loads to be controlled from the 1 device Input voltage: 12v DC or 24v DC Dimming Range 5-100% 	12v DC 360w 24v DC 720w



For detailed product specifications
visit www.Havit.com.au
or scan this QR code



HV9111



HV9211

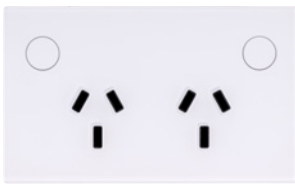
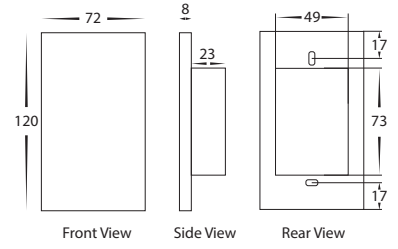

HV9114



HV9214

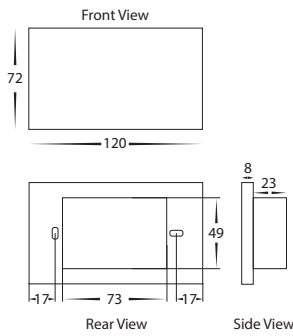
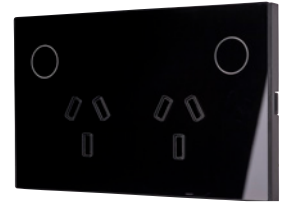

HV9112

WiFi Switches

- Set Scenes and Timers
- App Control using Tuya
- Works with Google Home and Amazon Alexa
- IP Rating: IP20



Compatible with major smart home systems.

PART NUMBER	DESCRIPTION	POWER
HV9111	White Wifi Dimmer Switch	240V 300w LED
HV9211	Black Wifi Dimmer Switch	240V 300w LED
HV9112	White Plug Base	240V 10A
HV9114	White Double Powerpoint	240V 10A
HV9214	Black Double Powerpoint	240V 10A





HV9115



HV9116

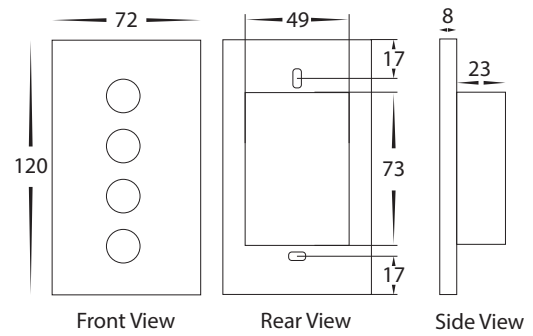
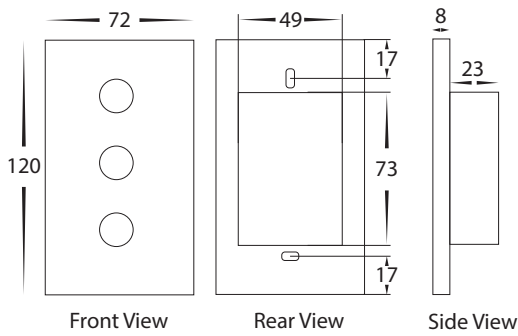

Fan Controller Wifi Switches

- With light or without light Fan Controllers
- App Control using Tuya App
- 3 Speeds
- Works with Google Home and Amazon Alexa
- IP Rating: IP20



Compatible with major smart home systems.



PART NUMBER	DESCRIPTION	POWER
HV9115	3 Speed Fan Controller without Light	240V
HV9116	3 Speed Fan Controller with Light	240V 150w(Light)



For detailed product specifications visit www.Havit.com.au or scan this QR code

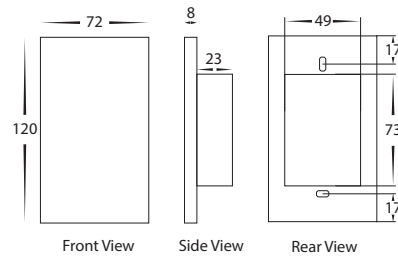
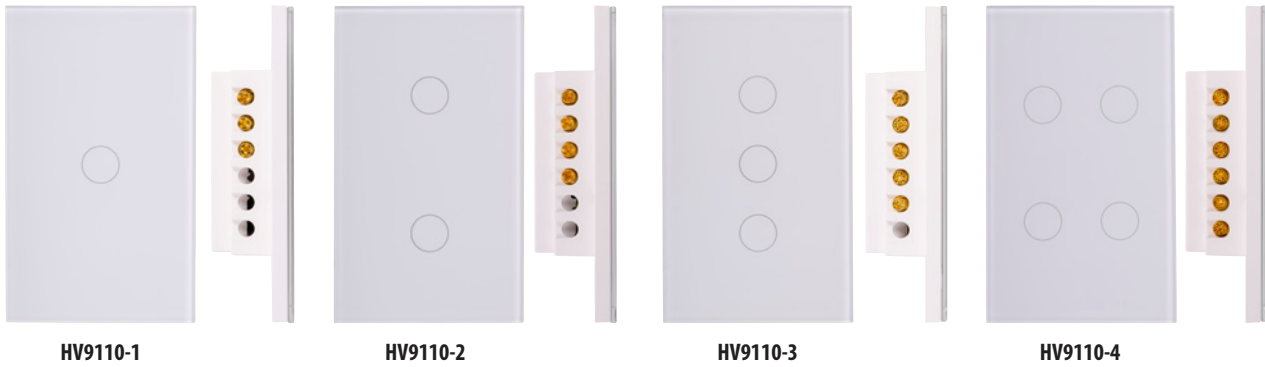

WiFi Switches

- White and White with Gold trim
- Glass Panel Front
- Available in 1, 2, 3 and 4 Gang
- App Control using Tuya
- Works with Google Home and Amazon Alexa
- Can be connected without Neutral
- IP Rating: IP20

Compatible with major smart home systems.

PART NUMBER	DESCRIPTION	POWER
HV9110-1	White 1 Gang Wifi Switch	240V 300w LED
HV9110-2	White 2 Gang Wifi Switch	240V 2x 300w LED
HV9110-3	White 3 Gang Wifi Switch	240V 3x 300w LED
HV9110-4	White 4 Gang Wifi Switch	240V 4x 300w LED
HV9120-1	White with Gold Trim 1 Gang Wifi Switch	240V 300w LED
HV9120-2	White with Gold Trim 2 Gang Wifi Switch	240V 2x 300w LED
HV9120-3	White with Gold Trim 3 Gang Wifi Switch	240V 3x 300w LED
HV9120-4	White with Gold Trim 4 Gang Wifi Switch	240V 4x 300w LED





HV9210-1

HV9210-2

HV9210-3

HV9210-4



HV9220-1

HV9220-2

HV9220-3

HV9220-4

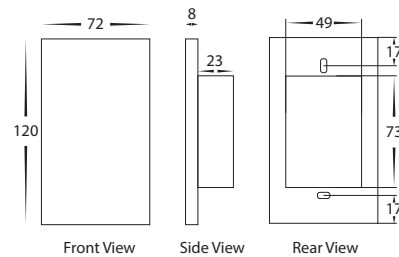

WiFi Switches

- Black and Black with Gold trim
- Glass Panel Front
- Available in 1, 2, 3 and 4 Gang
- App Control using Tuya
- Works with Google Home and Amazon Alexa
- Can be connected without Neutral
- IP Rating: IP20



Compatible with major smart home systems.



PART NUMBER	DESCRIPTION	POWER
HV9210-1	Black 1 Gang Wifi Switch	240V 300w LED
HV9210-2	Black 2 Gang Wifi Switch	240V 2x 300w LED
HV9210-3	Black 3 Gang Wifi Switch	240V 3x 300w LED
HV9210-4	Black 4 Gang Wifi Switch	240V 4x 300w LED
HV9220-1	Black with Gold Trim 1 Gang Wifi Switch	240V 300w LED
HV9220-2	Black with Gold Trim 2 Gang Wifi Switch	240V 2x 300w LED
HV9220-3	Black with Gold Trim 3 Gang Wifi Switch	240V 3x 300w LED
HV9220-4	Black with Gold Trim 4 Gang Wifi Switch	240V 4x 300w LED



For detailed product specifications visit www.Havit.com.au or scan this QR code

12V DC - IP66 Weatherproof

- 12v DC constant voltage
- Supplied with flex and plug
- Must be installed with adequate ventilation
- Suits Havit 12v LED products
- IP Rating: IP66

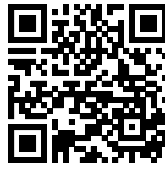

LED DRIVER SELECTOR TOOL

Scan QR Code for help selecting the correct LED Driver
www.havit.com.au/LDS



IMAGE	PART NUMBER	INPUT POWER	OUTPUT POWER	SIZE HxWxL(mm)
	HV9650S	240v AC	12v DC 10w	(H)21x (W)29x (L)89
	HV9651	240v AC	12v DC 20w	(H)28x (W)30x (L)162
	HV9652	240v AC	12v DC 30w	(H)22x (W)40x (L)148
	HV9653	240v AC	12v DC 60w	(H)31x (W)41x (L)179
	HV9654	240v AC	12v DC 100w	(H)46x (W)72x (L)210

High Power Factor 12V DC - IP66 Weatherproof

IMAGE	PART NUMBER	INPUT POWER	OUTPUT POWER	SIZE HxWxL(mm)
	HV9658-12V30W	240v AC	12v DC 30w	(H)28x (W)37x (L)212
	HV9658-12V60W	240v AC	12v DC 60w	(H)46x (W)67x (L)175
	HV9658-12V100W	240v AC	12v DC 100w	(H)46x (W)72x (L)215
	HV9658-12V150W	240v AC	12v DC 150w	(H)46x (W)68x (L)247
	HV9658-12V200W	240v AC	12v DC 200w	(H)46x (W)68x (L)247
	HV9658-12V275W	240v AC	12v DC 275w	(H)50x (W)95x (L)275

Slimline 12V DC - IP66 Weatherproof

IMAGE	PART NUMBER	INPUT POWER	OUTPUT POWER	SIZE HxWxL(mm)
	HV9658-12V60WS	240v AC	12v DC 60w	(H)22x (W)40x (L)253
	HV9658-12V95WS	240v AC	12v DC 95w	(H)22x (W)40x (L)298





24V DC - IP66 Weatherproof

- 24v DC constant voltage
- Supplied with flex and plug
- Must be installed with adequate ventilation
- Suits Havit 24v LED products
- IP Rating: IP66









LED DRIVER SELECTOR TOOL
Scan QR Code for help selecting the
correct LED Driver
www.havit.com.au/LDS





IMAGE	PART NUMBER	INPUT POWER	OUTPUT POWER	SIZE HxWxL(mm)
	HV9652-24V	240v AC	24v DC 30w	(H)22x (W)40x (L)148
	HV9653-24V	240v AC	24v DC 60w	(H)31x (W)41x (L)179
	HV9654-24V	240v AC	24v DC 100w	(H)46x (W)72x (L)210

High Power Factor 24V DC - IP66 Weatherproof

IMAGE	PART NUMBER	INPUT POWER	OUTPUT POWER	SIZE HxWxL(mm)
	HV9658-24V30W	240v AC	24v DC 30w	(H)28x (W)37x (L)212
	HV9658-24V60W	240v AC	24v DC 60w	(H)46x (W)67x (L)175
	HV9658-24V100W	240v AC	24v DC 100w	(H)46x (W)72x (L)215
	HV9658-24V150W	240v AC	24v DC 150w	(H)46x (W)68x (L)247
	HV9658-24V200W	240v AC	24v DC 200w	(H)46x (W)68x (L)247
	HV9658-24V300W	240v AC	24v DC 300w	(H)50x (W)95x (L)275

Slimline 24V DC - IP66 Weatherproof

IMAGE	PART NUMBER	INPUT POWER	OUTPUT POWER	SIZE HxWxL(mm)
	HV9658-24V60WS	240v AC	24v DC 60w	(H)22x (W)40x (L)253
	HV9658-24V95WS	240v AC	24v DC 95w	(H)22x (W)40x (L)298



For detailed product specifications
visit www.Havit.com.au
or scan this QR code

TRIAC

- TRIAC Dimmable LED drivers
- Constant voltage 12v DC
- Supplied with flex and plug
- Must be installed with adequate ventilation
- Suits Havit 12v DC single coloured LED strip
- Can be used with HV9625

12V DC IP20 INDOOR



LED DRIVER SELECTOR TOOL
Scan QR Code for help selecting
the correct LED Driver
www.havit.com.au/LDS



IMAGE	PART NUMBER	INPUT POWER	OUTPUT POWER	SIZE HxWxL (mm)
	HV9660-12V30W	240v AC	12v DC 30w	(H)20x (W)54x (L)155
	HV9660-12V60W	240v AC	12v DC 60w	(H)24x (W)61x (L)178

12V DC IP66 WEATHERPROOF



LED DRIVER SELECTOR TOOL
Scan QR Code for help selecting
the correct LED Driver
www.havit.com.au/LDS



IMAGE	PART NUMBER	INPUT POWER	OUTPUT POWER	SIZE HxWxL (mm)
	HV9660-12V100W	240v AC	12v DC 100w	(H)43x (W)70x (L)230
	HV9660-12V150W	240v AC	12v DC 150w	(H)47x (W)78x (L)265
	HV9660-12V200W	240v AC	12v DC 200w	(H)47x (W)78x (L)265
	HV9660-12V300W	240v AC	12v DC 300w	(H)47x (W)78x (L)278



TRIAC



- TRIAC Dimmable LED drivers
- Constant voltage 24V DC
- Supplied with flex and plug
- Must be installed with adequate ventilation
- Suits Havit 24v DC single coloured LED strip
- Can be used with HV9625

24V DC IP20 INDOOR



LED DRIVER SELECTOR TOOL
Scan QR Code for help selecting the
correct LED Driver
www.havit.com.au/LDS







IMAGE	PART NUMBER	INPUT POWER	OUTPUT POWER	SIZE HxWxL(mm)
	HV9660-24V30W	240v AC	24v DC 30w	(H)20x (W)54x (L)155
	HV9660-24V60W	240v AC	24v DC 60w	(H)24x (W)61x (L)178

24V DC IP66 WEATHERPROOF



LED DRIVER SELECTOR TOOL
Scan QR Code for help selecting the
correct LED Driver
www.havit.com.au/LDS



IMAGE	PART NUMBER	INPUT POWER	OUTPUT POWER	SIZE HxWxL(mm)
	HV9660-24V100W	240v AC	24v DC 100w	(H)43x (W)70x (L)230
	HV9660-24V150W	240v AC	24v DC 150w	(H)47x (W)78x (L)265
	HV9660-24V200W	240v AC	24v DC 200w	(H)47x (W)78x (L)265
	HV9660-24V300W	240v AC	24v DC 300w	(H)47x (W)78x (L)278



For detailed product specifications
visit www.Havit.com.au
or scan this QR code

2in1 Dimmable Drivers

- Triac + 0-1/10V Dimming
- Constant voltage 12v or 24v DC
- Supplied with flex and plug
- Must be installed with adequate ventilation
- Suits Havit 12v or 24v DC single coloured LED strip
- Can be used with either HV9625 or HV9629

12V DC IP66 WEATHERPROOF

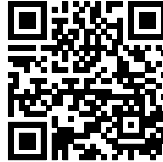

LED DRIVER SELECTOR TOOL
Scan QR Code for help selecting
the correct LED Driver
www.havit.com.au/LDS



IMAGE	PART NUMBER	INPUT POWER	OUTPUT POWER	SIZE HxWxL (mm)
	HV9661-12V30W	240v AC	12v DC 30w	(H)20x (W)32x (L)260
	HV9661-12V60W	240v AC	12v DC 60w	(H)20x (W)32x (L)300
	HV9661-12V100W	240v AC	12v DC 100w	(H)23x (W)32x (L)330
	HV9661-12V150W	240v AC	12v DC 150w	(H)23x (W)32x (L)368

24V DC IP66 WEATHERPROOF



LED DRIVER SELECTOR TOOL
Scan QR Code for help selecting
the correct LED Driver
www.havit.com.au/LDS



IMAGE	PART NUMBER	INPUT POWER	OUTPUT POWER	SIZE HxWxL (mm)
	HV9661-24V30W	240v AC	24v DC 30w	(H)20x (W)32x (L)260
	HV9661-24V60W	240v AC	24v DC 60w	(H)20x (W)32x (L)300
	HV9661-24V100W	240v AC	24v DC 100w	(H)23x (W)32x (L)330
	HV9661-24V150W	240v AC	24v DC 150w	(H)23x (W)32x (L)368



Dali 2 + Push Dim Dimmable Drivers



- Dali Dimmable LED drivers
- Constant voltage 12v or 24v DC
- Can be used with Push Dimmer
- Supplied with flex and plug
- Must be installed with adequate ventilation
- Suits Havit 12v or 24v DC single coloured LED strip

12V DC IP66 WEATHERPROOF



LED DRIVER SELECTOR TOOL
Scan QR Code for help selecting the
correct LED Driver
www.havit.com.au/LDS



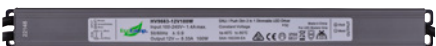
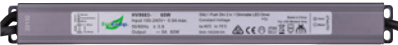

IMAGE	PART NUMBER	INPUT POWER	OUTPUT POWER	SIZE HxWxL (mm)
	HV96632-12V30W	240v AC	12v DC 30w	(H)23.6x (W)38.5x (L)268
	HV96632-12V60W	240v AC	12v DC 60w	(H)23.6x (W)38.5x (L)308
	HV96632-12V100W	240v AC	12v DC 100w	(H)23.6x (W)38.5x (L)338
	HV96632-12V150W	240v AC	12v DC 150w	(H)23.6x (W)38.5x (L)377

24V DC IP66 WEATHERPROOF



LED DRIVER SELECTOR TOOL
Scan QR Code for help selecting the
correct LED Driver
www.havit.com.au/LDS



IMAGE	PART NUMBER	INPUT POWER	OUTPUT POWER	SIZE HxWxL (mm)
	HV96632-24V30W	240v AC	24v DC 30w	(H)23.6x (W)38.5x (L)268
	HV96632-24V60W	240v AC	24v DC 60w	(H)23.6x (W)38.5x (L)308
	HV96632-24V100W	240v AC	24v DC 100w	(H)23.6x (W)38.5x (L)338
	HV96632-24V150W	240v AC	24v DC 150w	(H)23.6x (W)38.5x (L)377



For detailed product specifications
visit www.Havit.com.au
or scan this QR code

Dali 2 + Push Dim Dimmable Drivers

- 2in1 Dimmable LED Driver
- Dali 2 Dimmable + Push Dim
- Adjustable settings using NFC APP
- Dimming Range: 5%-100%
- High Power Factor 0.95
- Flicker Free
- Flex and Plug Included

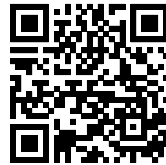

LED DRIVER SELECTOR TOOL
Scan QR Code for help selecting
the correct LED Driver
www.havit.com.au/LDS



12V DC IP20 INDOOR

IMAGE	PART NUMBER	INPUT POWER	OUTPUT POWER	SIZE HxWxL (mm)
	HV96631-12V30W	240V AC	12v DC 30W	(H)20x (W)54x (L)x163.7
	HV96631-12V60W	240V AC	12v DC 60W	(H)24x (W)62x (L)x184.7



LED DRIVER SELECTOR TOOL
Scan QR Code for help selecting
the correct LED Driver
www.havit.com.au/LDS



12V DC IP66 WEATHERPROOF

IMAGE	PART NUMBER	INPUT POWER	OUTPUT POWER	SIZE HxWxL (mm)
	HV96631-12V100W	240V AC	12v DC 100W	(H)25.1x (W)78x (L)x219
	HV96631-12V150W	240V AC	12v DC 150W	(H)25.1x (W)78x (L)x266
	HV96631-12V200W	240V AC	12v DC 200W	(H)25.1x (W)78x (L)x267
	HV96631-12V300W	240V AC	12v DC 300W	(H)25.1x (W)78x (L)x289



Dali 2 + Push Dim Dimmable Drivers



- 2in1 Dimmable LED Driver
- Dali 2 Dimmable + Push Dim
- Adjustable settings using NFC APP
- Dimming Range: 5%-100%
- High Power Factor 0.95
- Flicker Free
- Flex and Plug Included



LED DRIVER SELECTOR TOOL
Scan QR Code for help selecting the
correct LED Driver
www.havit.com.au/LDS



24V DC IP20 INDOOR





IMAGE	PART NUMBER	INPUT POWER	OUTPUT POWER	SIZE HxWxL (mm)
	HV96631-24V30W	240V AC	24V DC 30W	(H)20x (W)54x (L)x163.7
	HV96631-24V60W	240V AC	24V DC 60W	(H)24x (W)62x (L)x184.7



LED DRIVER SELECTOR TOOL
Scan QR Code for help selecting
the correct LED Driver
www.havit.com.au/LDS



24V DC IP66 WEATHERPROOF

IMAGE	PART NUMBER	INPUT POWER	OUTPUT POWER	SIZE HxWxL (mm)
	HV96631-24V100W	240V AC	24V DC 100W	(H)25.1x (W)78x (L)x219
	HV96631-24V150W	240V AC	24V DC 150W	(H)25.1x (W)78x (L)x266
	HV96631-24V200W	240V AC	24V DC 200W	(H)25.1x (W)78x (L)x267
	HV96631-24V300W	240V AC	24V DC 300W	(H)25.1x (W)78x (L)x289



For detailed product specifications
visit www.Havit.com.au
or scan this QR code

12V DC Constant Voltage

- Must be installed with adequate ventilation
- Suits Havit 12v LED products
- IP Rating: IP65

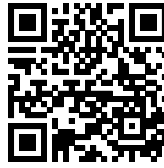

LED DRIVER SELECTOR TOOL
Scan QR Code for help selecting
the correct LED Driver
www.havit.com.au/LDS



IMAGE	PART NUMBER	INPUT POWER	OUTPUT POWER	SIZE HxWxL (mm)
	HV9665-12V4W	240v AC	12v DC 4w	(H)21x (W)27x (L)47

12V DC Constant Voltage

- Supplied with flex and plug
- Must be installed with adequate ventilation
- Suits Havit 12v LED Strip
- IP Rating: IP20



LED DRIVER SELECTOR TOOL
Scan QR Code for help selecting
the correct LED Driver
www.havit.com.au/LDS



IMAGE	PART NUMBER	INPUT POWER	OUTPUT POWER	SIZE HxWxL (mm)
	HV9666-12V20W	240v AC	12v DC 20w	(H)13x (W)50x (L)128
	HV9666-12V30W	240v AC	12v DC 30w	(H)16x (W)53x (L)155
	HV9667-12V60W	240v AC	12v DC 60w	(H)32x (W)61x (L)184
	HV9667-12V75W	240v AC	12v DC 75w	(H)32x (W)61x (L)184



24V DC Constant Voltage

- Must be installed with adequate ventilation
- Suits Havit 24v LED products
- IP Rating: IP65



LED DRIVER SELECTOR TOOL
Scan QR Code for help selecting the
correct LED Driver
www.havit.com.au/LDS



IMAGE	PART NUMBER	INPUT POWER	OUTPUT POWER	SIZE HxWxL (mm)
	HV9665-24V4W	240v AC	24v DC 4w	(H)21x (W)27x (L)47

24V DC Constant Voltage

- Supplied with flex and plug
- Must be installed with adequate ventilation
- Suits Havit 24v LED Strip
- IP Rating: IP20



LED DRIVER SELECTOR TOOL
Scan QR Code for help selecting the
correct LED Driver
www.havit.com.au/LDS

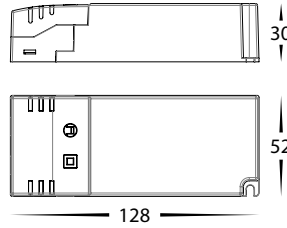
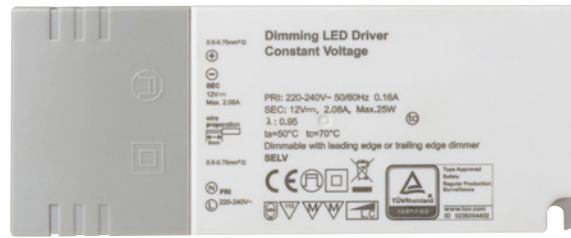

IMAGE	PART NUMBER	INPUT POWER	OUTPUT POWER	SIZE HxWxL (mm)
	HV9666-24V20W	240v AC	24v DC 20w	(H)13x (W)50x (L)128
	HV9666-24V30W	240v AC	24v DC 30w	(H)16x (W)53x (L)155
	HV9667-24V60W	240v AC	24v DC 60w	(H)32x (W)61x (L)184
	HV9667-24V75W	240v AC	24v DC 75w	(H)32x (W)61x (L)184



For detailed product specifications
visit www.Havit.com.au
or scan this QR code

HV9668-12V25W



HV9668-12V50W

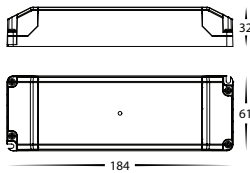

HV9668-12V100W

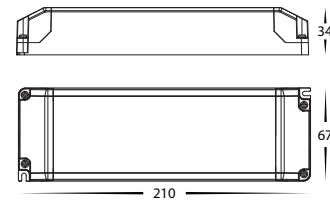
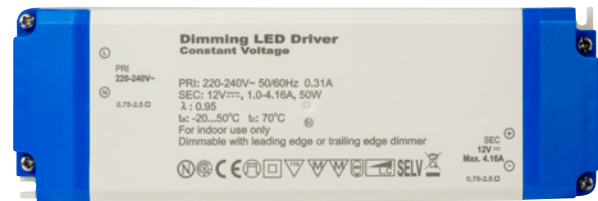

12v DC Triac Dimmable

- Triac Dimmable LED Drivers
- Constant Voltage 12v DC
- Supplied with Flex & Plug
- Must be installed with Adequate Ventilation
- Suits Havit 12v DC LED Strips
- Can be used with HV9625
- IP Rating: IP20



PART NUMBER	INPUT POWER	OUTPUT POWER	SIZE HxWxL(mm)
HV9668-12V25W	240V	12v DC 25W	(H)30(W)52(L)128
HV9668-12V50W	240V	12v DC 50W	(H)32(W)61(L)184
HV9668-12V100W	240V	12v DC 100W	(H)34(W)67(L)210



HV9668-24V25W

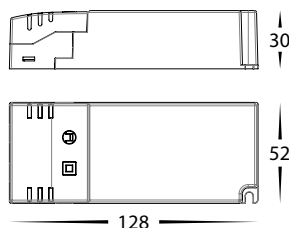
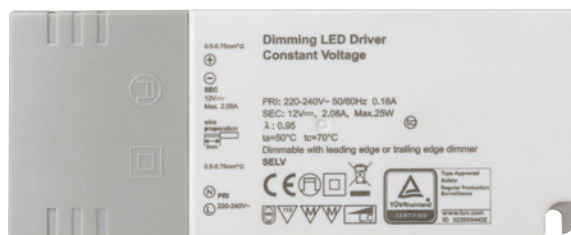

HV9668-24V50W

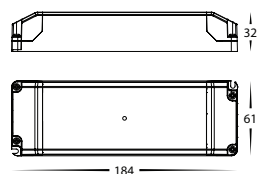

HV9668-24V100W

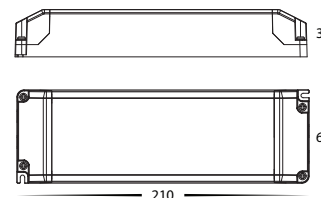

24v DC Triac Dimmable





- Triac Dimmable LED Drivers
- Constant Voltage 24V DC
- Supplied with Flex & Plug
- Must be installed with Adequate Ventilation
- Suits Havit 24V DC LED Strips
- Can be used with HV9625
- IP Rating: IP20



PART NUMBER	INPUT POWER	OUTPUT POWER	SIZE HxWxL(mm)
HV9668-24V25W	240V	24V DC 25W	(H)30(W)52(L)128
HV9668-24V50W	240V	24V DC 50W	(H)32(W)61(L)184
HV9668-24V100W	240V	24V DC 100W	(H)34(W)67(L)210

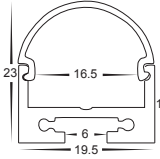
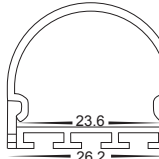
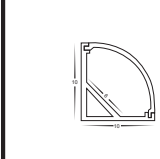
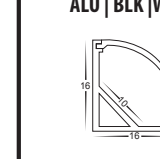
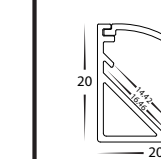
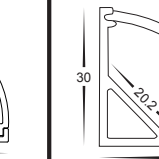
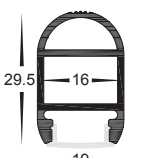
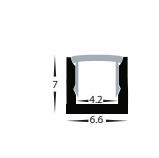
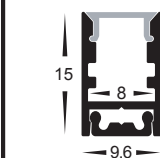
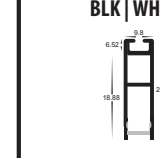
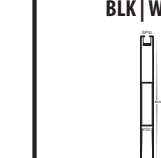

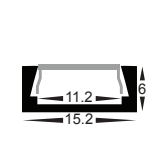
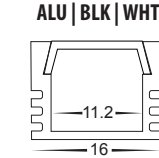
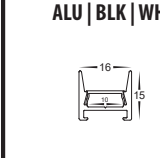
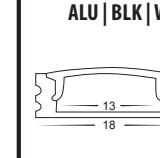
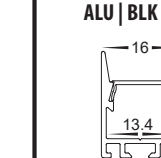
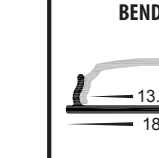
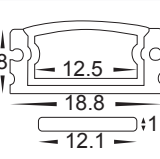
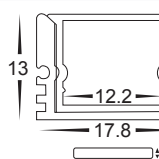
For detailed product specifications visit www.Havit.com.au or scan this QR code

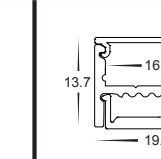
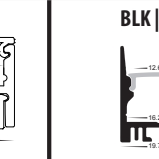
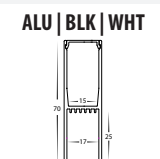
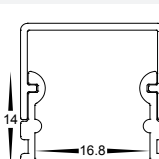
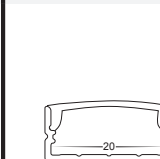
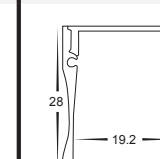
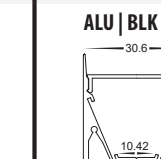
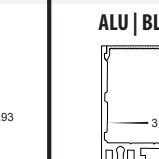
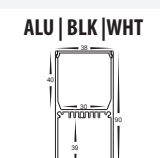
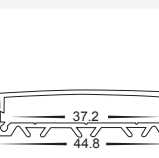
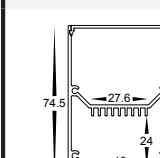
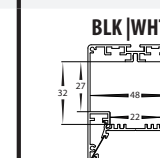
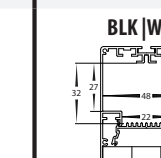
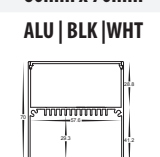
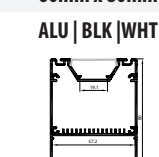
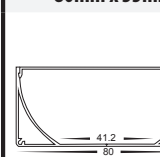
<p>19mm x 21mm</p>  <p>HV9690-2119 - Page 309</p>	<p>26mm x 18mm</p>  <p>HV9690-2618 - Page 310</p>	<p>10mm x 10mm</p>  <p>HV9691-1010 - Page 311</p>	<p>16mm x 16mm ALU BLK WHT</p>  <p>HV9691-1616 - Page 312</p>	<p>20mm x 20mm</p>  <p>HV9691-2020 - Page 313</p>	<p>30mm x 30mm</p>  <p>HV9691-3030 - Page 314</p>
<p>19mm x 30mm</p>  <p>HV9692-1930 - Page 315</p>	<p>5mm x 7mm</p>  <p>HV9693-0607 - Page 316</p>	<p>9mm x 15mm</p>  <p>HV9693-0915 - Page 317</p>	<p>10mm x 25mm BLK WHT</p>  <p>HV9693-1045 - BLK - Page 318</p>	<p>10mm x 89mm BLK WHT</p>  <p>HV9693-1089 - Page 319</p>	<p>10mm x 7mm</p>  <p>HV9693-1007 - Page 320</p>
<p>15mm x 6mm</p>  <p>HV9693-1506 - Page 321</p>	<p>16mm x 12mm ALU BLK WHT</p>  <p>HV9693-1612 - Page 322</p>	<p>16mm x 15mm ALU BLK WHT</p>  <p>HV9693-1615 - Page 323</p>	<p>18mm x 9mm ALU BLK WHT</p>  <p>HV9693-1707 - Page 324</p>	<p>16mm x 22mm ALU BLK WHT</p>  <p>HV9693-1622 - Page 325</p>	<p>18mm x 6mm BENDABLE</p>  <p>HV9693-1806 - Page 326</p>
<p>19mm x 8mm</p>  <p>HV9693-1808 - Page 327</p>	<p>18mm x 13mm</p>  <p>HV9693-1812 - Page 328</p>	<p>18mm x 15mm ALU BLK WHT</p>  <p>HV9693-1815 - Page 329</p>	<p>18mm x 96mm BLK WHT</p>  <p>HV9693-1896 - Page 330</p>	<p>19mm x 14mm</p>  <p>HV9693-1922 - Page 331</p>	<p>20mm x 25mm BLK WHT</p>  <p>HV9693-2025 - Page 332</p>
<p>20mm x 70mm ALU BLK WHT</p>  <p>HV9693-2070 - Page 333</p>	<p>21mm x 21mm</p>  <p>HV9693-2114 - Page 334</p>	<p>23mm x 10mm</p>  <p>HV9693-2310 - Page 335</p>	<p>23mm x 28mm</p>  <p>HV9693-2320 - Page 336</p>	<p>31mm x 36mm ALU BLK WHT</p>  <p>HV9693-3136 - Page 337</p>	<p>35mm x 37mm ALU BLK WHT</p>  <p>HV9693-3537 - Page 338</p>
<p>38mm x 90mm ALU BLK WHT</p>  <p>HV9693-3890 - Page 339</p>	<p>45mm x 11mm</p>  <p>HV9693-4511 - Page 340</p>	<p>49mm x 75mm</p>  <p>HV9693-4975 - Page 341</p>	<p>52mm x 70mm BLK WHT</p>  <p>HV9693-5270 - Page 342</p>	<p>52mm x 70mm BLK WHT</p>  <p>HV9693-5271 - Page 343</p>	
<p>60mm x 70mm ALU BLK WHT</p>  <p>HV9693-6070 - Page 344</p>	<p>60mm x 80mm ALU BLK WHT</p>  <p>HV9693-6080 - Page 345</p>	<p>80mm x 35mm</p>  <p>HV9693-8035 - Page 346</p>	<p>DIAGRAMS ARE NOT TO SCALE</p>		













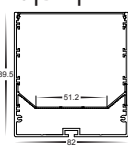
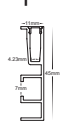
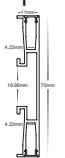

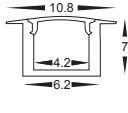
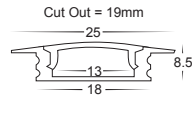
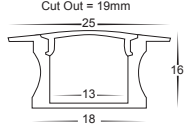
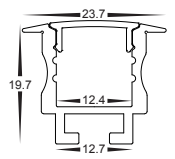
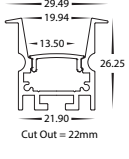
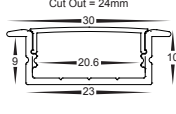
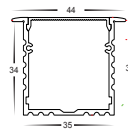
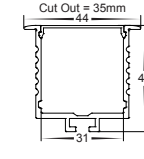
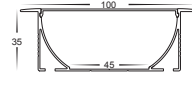
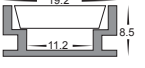
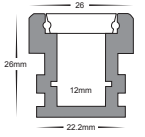
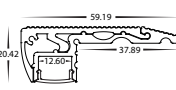
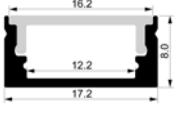
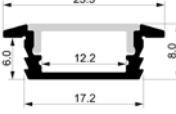
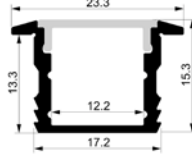
PROFILE & STRIP COMPATIBILITY

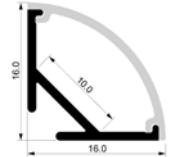
Scan to view all compatible LED Strip models

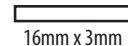
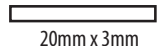
www.havit.com.au/PCC



For detailed product specifications visit www.havit.com.au or scan this QR code

82mm x 90mm ALU BLK WHT  HV9693-8090 - Page 347	11mm x 45mm BLK WHT  HV9694-1145 - Page 348	11mm x 70mm BLK WHT  HV9694-1170 - Page 349	6mm x 25mm  HV9694-0625 - Page 350	11mm x 7mm  HV9695-1107 - Page 351	25mm x 9mm ALU BLK WHT Cut Out = 19mm  HV9695-2507 - Page 352
25mm x 16mm ALU BLK WHT Cut Out = 19mm  HV9695-2515 - Page 353	24mm x 20mm Cut Out = 19mm  HV9695-2520 - Page 354	30mm x 27mm  HV9695-2926 - Page 355	30mm x 10mm Cut Out = 24mm  HV9695-2810 - Page 356	44mm x 35mm Cut Out = 35mm  HV9695-4435 - Page 357	44mm x 40mm Cut Out = 35mm  HV9695-4540 - Page 358
100mm x 35mm Cut Out = 81mm  HV9695-9835 - Page 359	19mm x 9mm  HV9698-1908 - Page 360	26mm x 26mm  HV9698-2626 - Page 361	60mm x 21mm  HV9698-6020 - Page 362	17mm x 8mm  HV9699-1708-2M - Page 363	23mm x 8mm  HV9699-2308-2M - Page 363
23mm x 15mm  HV9699-2315-2M - Page 364	27mm x 7mm  HV9699-2707-2M - Page 364	26mm x 26mm  HV9699-1616-2M - Page 364	10mm Heat Sink Heat dissipating surface to suit Havit LED strip  HV9705-1003 - Page 365	16mm Heat Sink Heat dissipating surface to suit Havit LED strip  HV9705-1603 - Page 365	20mm Heat Sink Heat dissipating surface to suit Havit LED strip  HV9705-2003 - Page 365
2m Suspension kit Suits HV9693-6080  HV9705-9950 - Page 365	2m Suspension kit Suits HV9693-6080  HV9705-9952 - Page 365	2m Suspension kit Suits Havit Profile  HV9705-9953 - Page 365	Suspension Cable Suits HV9705-9952 & HV9705-9953  HV9705-9954 - Page 365	Low Voltage Cable Suits HV9705-9956  HV9705-9955 - Page 365	Suspension kit Suits HV9705-9955  HV9705-9956 - Page 365

DIAGRAMS ARE NOT TO SCALE

*All profile custom cut lengths will include end caps.

E.G. 2000mm will be cut at 1995mm to allow for the installation of end caps.

*Custom Cut Lengths are charged up to the Half Metre. Eg. 1200mm will be charged at 1500mm

*Powder coating available for most models in black or white at an additional cost per metre.



PROFILE & STRIP COMPATIBILITY

Scan to view all compatible LED Strip models
www.havit.com.au/PCC



For detailed product specifications visit www.Havit.com.au or scan this QR code

Semi Round LED Profile

- Shallow square profile with rounded diffuser
- UV Stabilised PC diffuser

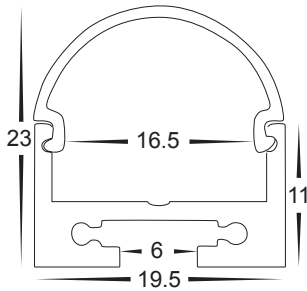

PROFILE & STRIP COMPATIBILITY

Scan to view all compatible LED Strip models
www.havit.com.au/PCC



PART NUMBER	DESCRIPTION	IP RATING	MAX LENGTH
HV9690-2119	Shallow Square Aluminium Profile with Rounded Diffuser - Kit - / Metre Custom Cut Length. Supplied with Aluminium, Diffuser + 2x end caps per length	IP20	3 metres
HV9690-2119-3M	3m Length includes aluminium, diffuser + 6x end caps	IP20	3 metres

SAMPLE INSTALLATION METHOD

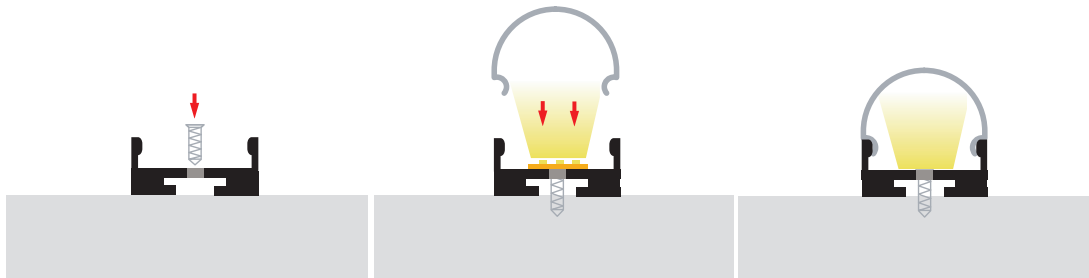

Semi Round LED Profile

- Shallow square profile with rounded diffuser
- UV Stabilised PC diffuser

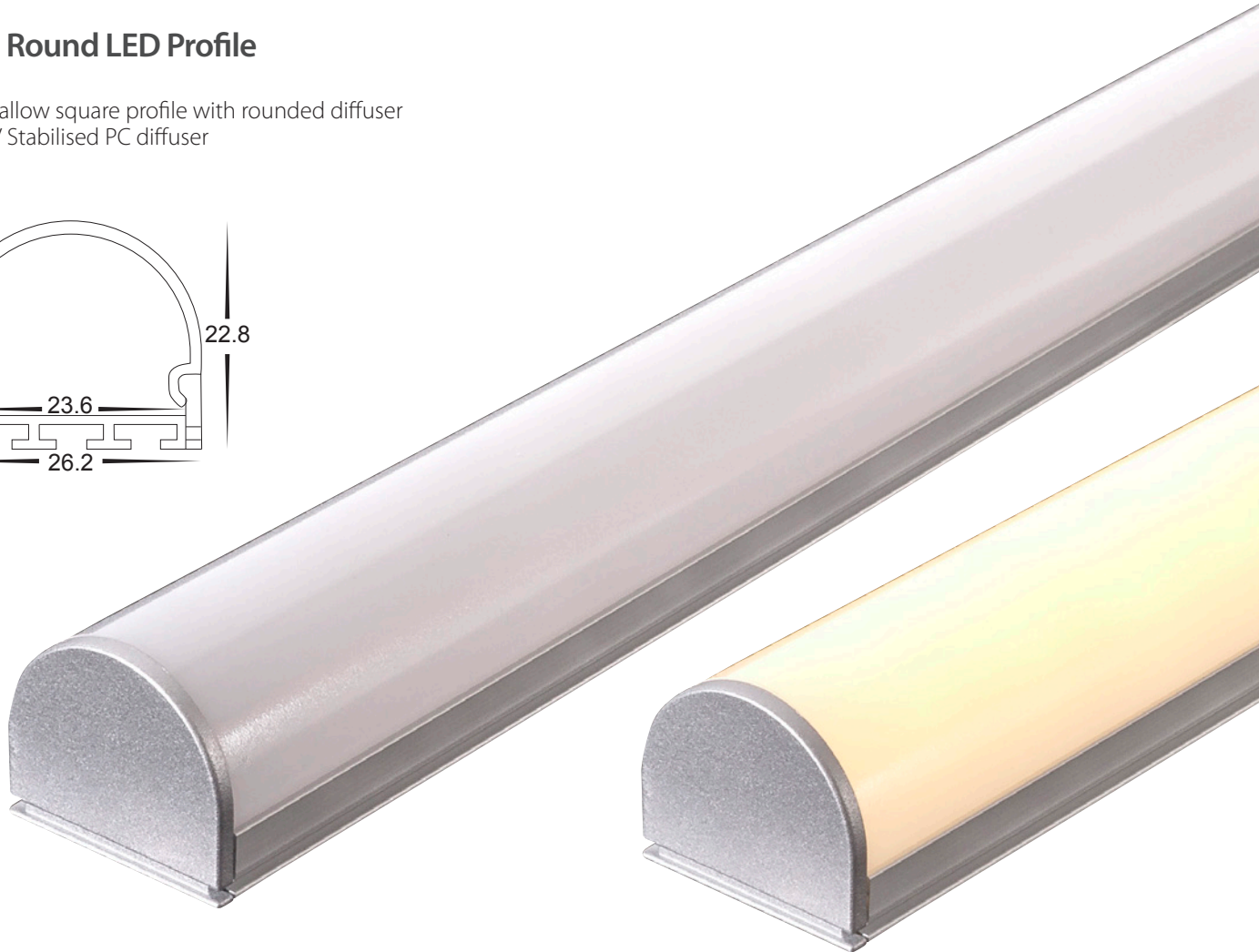
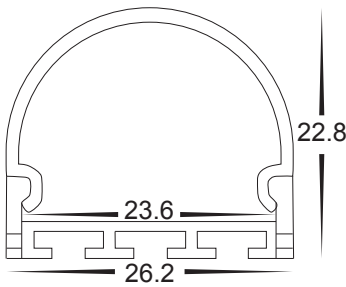

PROFILE & STRIP COMPATIBILITY

Scan to view all compatible LED Strip models
www.havit.com.au/PCC



PART NUMBER	DESCRIPTION	IP RATING	MAX LENGTH
HV9690-2618	Shallow Square Aluminium Profile with Rounded Diffuser - Kit - / Metre Custom Cut Length. Supplied with Aluminium, Diffuser + 2x end caps per length	IP20	3 metres
HV9690-2618-3M	3m Length includes aluminium, diffuser + 6x end caps	IP20	3 metres

SAMPLE INSTALLATION METHOD

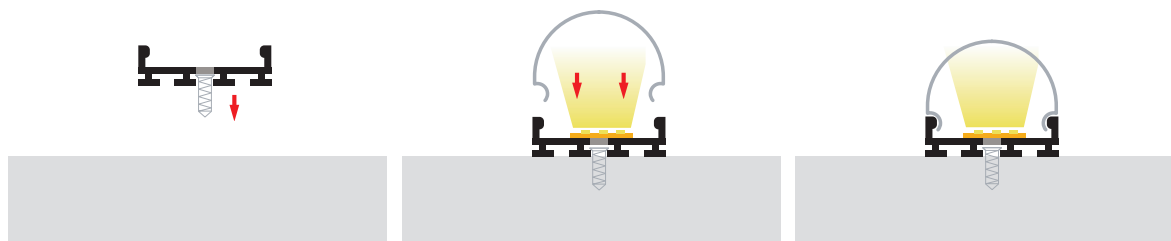

For detailed product specifications visit www.Havit.com.au or scan this QR code

Micro Corner LED Profile

- 90 degree corner profile
- UV Stabilised PC diffuser

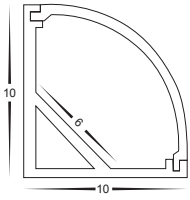

Powder Coating Available*



PROFILE & STRIP COMPATIBILITY

Scan to view all compatible LED Strip models
www.havit.com.au/PCC



PART NUMBER	DESCRIPTION	IP RATING	MAX LENGTH
HV9691-1010	90° Corner Aluminium Profile with PC Diffuser - Kit - / Metre. Custom Cut Length. Supplied with Aluminium, Diffuser, 2x mounting clips per metre + 2x end caps per length	IP20	3 metres
HV9691-1010-3M	3m Length includes aluminium, diffuser + 6x end caps & 6x mounting clips	IP20	3 metres

SAMPLE INSTALLATION METHOD

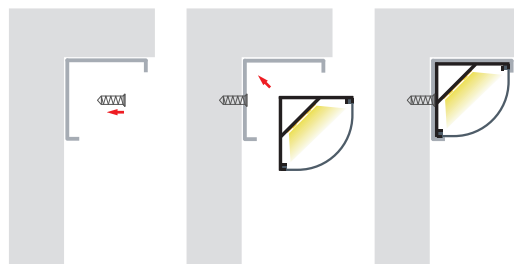

Corner LED Profile

- 90 degree corner profile
- UV Stabilised PC diffuser

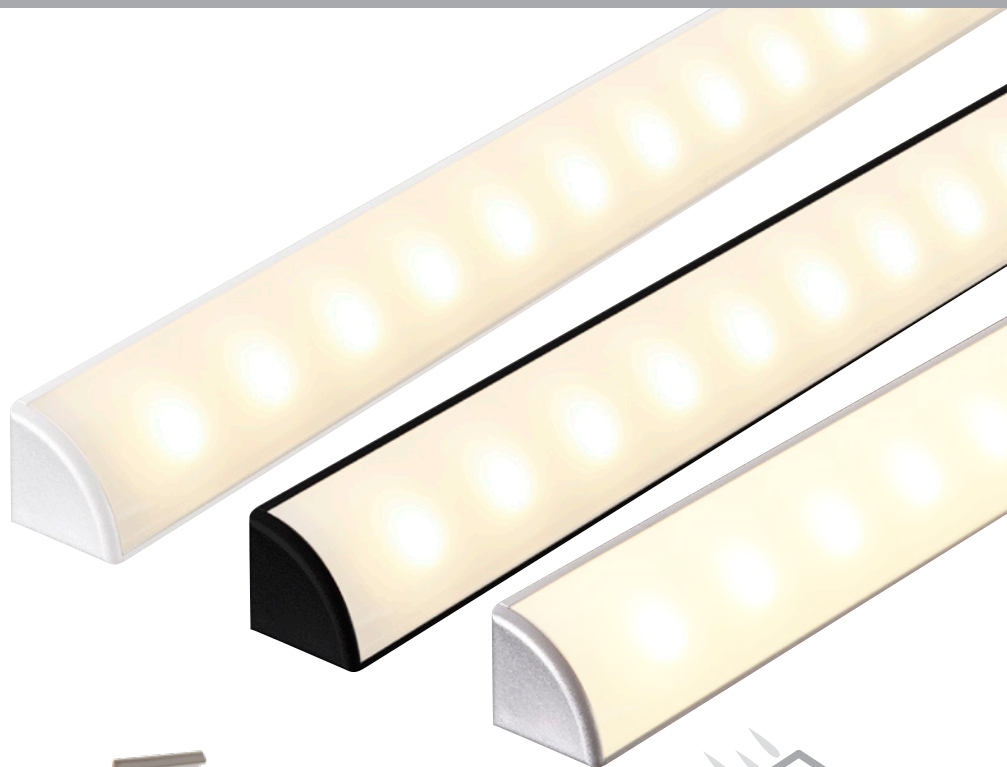
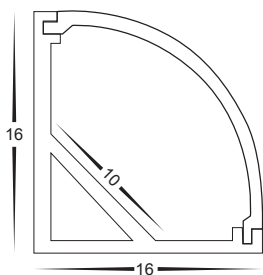



PROFILE & STRIP COMPATIBILITY

Scan to view all compatible LED Strip models
www.havit.com.au/PCC



PART NUMBER	DESCRIPTION	IP RATING	MAX LENGTH
HV9691-1616	90° Corner Aluminium Profile with PC Diffuser - Kit - / Metre. Custom Cut Length. Supplied with Aluminium, Diffuser, 2x mounting clips per metre + 2x end caps per length	IP20	3 metres
HV9691-1616-3M	3m Length includes aluminium, diffuser + 6x end caps & 6x mounting clips	IP20	3 metres
HV9691-1616-BLK	90° Corner Black Aluminium Profile with PC Diffuser - Kit - / Metre. Custom Cut Length. Supplied with Aluminium, Diffuser, 2x mounting clips per metre + 2x end caps per length	IP20	3 metres
HV9691-1616-BLK-3M	3m Length includes aluminium, diffuser + 6x end caps & 6x mounting clips	IP20	3 metres
HV9691-1616-WHT	90° Corner White Aluminium Profile with PC Diffuser - Kit - / Metre. Custom Cut Length. Supplied with Aluminium, Diffuser, 2x mounting clips per metre + 2x end caps per length	IP20	3 metres
HV9691-1616-WHT-3M	3m Length includes aluminium, diffuser + 6x end caps & 6x mounting clips	IP20	3 metres

HAVIT COMPATIBLE ACCESSORIES

	HV9691-1616-SD-ROLL: Diffuser available for continuous run of up to 20 metres
	HV9691-1616-BLKSD: Black diffuser to suit HV9691-1616 up to 3m length

SAMPLE INSTALLATION METHOD

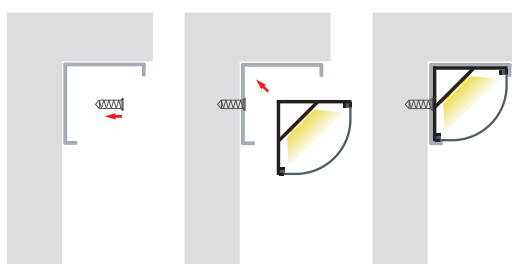

For detailed product specifications visit www.Havit.com.au or scan this QR code

Corner LED profile

- 90 degree corner profile
- UV Stabilised diffuser

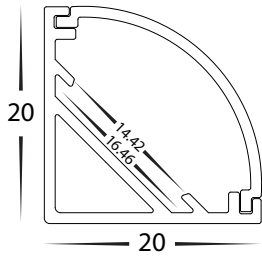

PROFILE & STRIP COMPATIBILITY
 Scan to view all compatible
 LED Strip models
www.havit.com.au/PCC



PART NUMBER	DESCRIPTION	IP RATING	MAX LENGTH
HV9691-2020	Corner Aluminium Profile with PC Diffuser - Kit - /Metre. Custom Cut Length Supplied with Aluminium, Diffuser , 2x mounting clips per metre + 2x end caps per length	IP20	3 metres
HV9691-2020-3M	3m Length includes aluminium, diffuser, 6x mounting clips + 6x end caps	IP20	3 metres

SAMPLE INSTALLATION METHOD

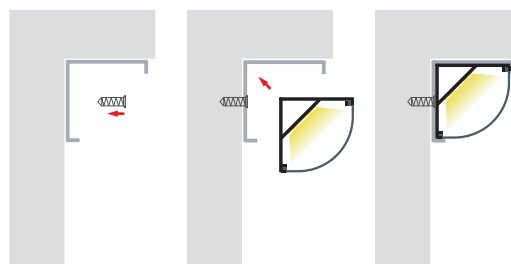

Corner LED Profile

- 90 degree corner profile
- UV Stabilised PC diffuser

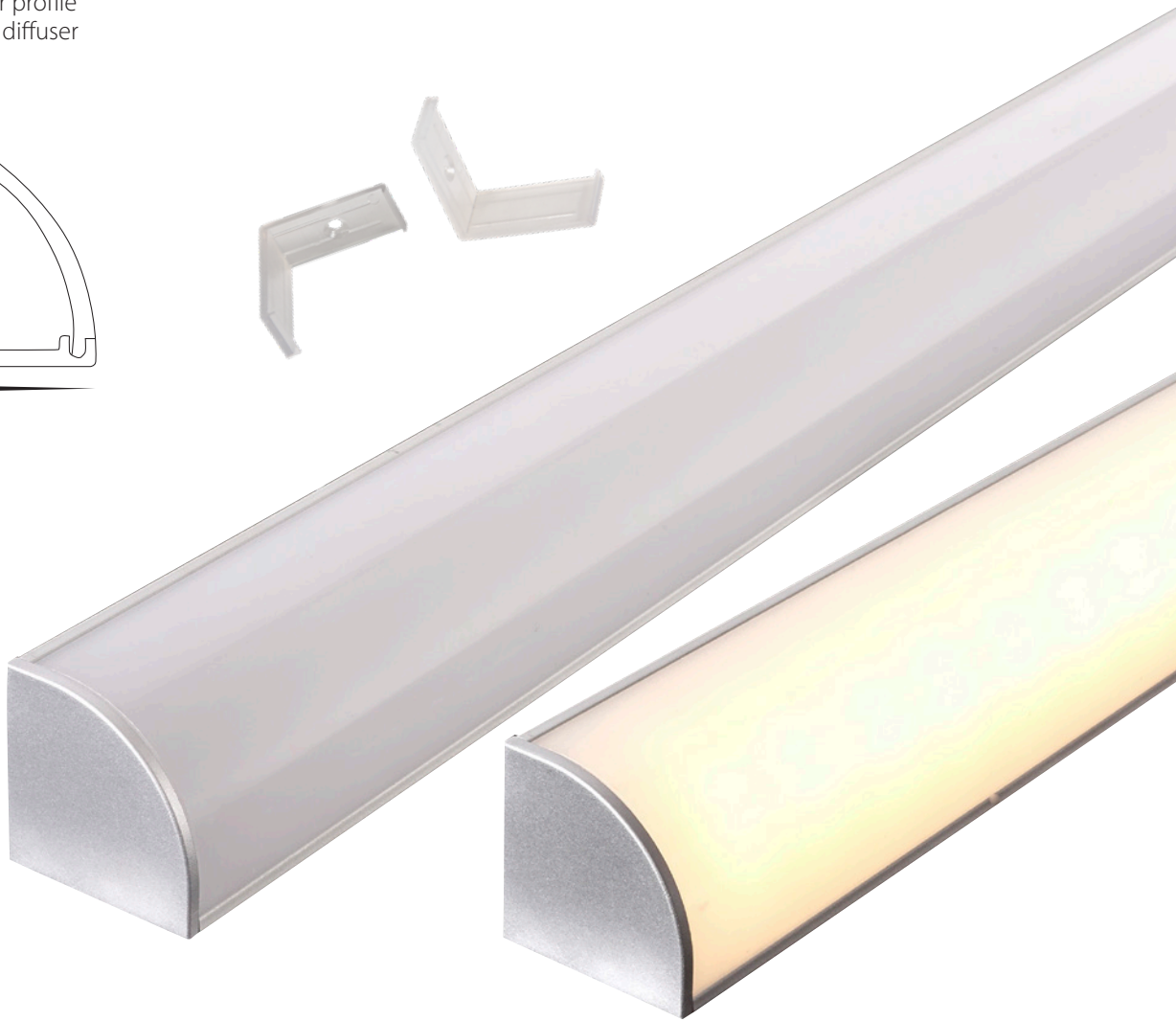
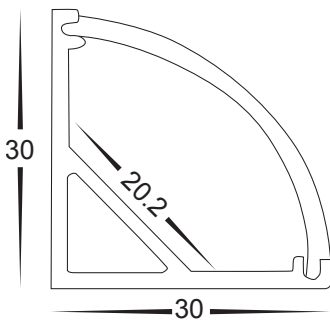

PROFILE & STRIP COMPATIBILITY

Scan to view all compatible LED Strip models
www.havit.com.au/PCC



PART NUMBER	DESCRIPTION	IP RATING	MAX LENGTH
HV9691-3030	90° Corner Aluminium Profile with PC Diffuser - Kit - / Metre. Custom Cut Length. Supplied with Aluminium, Diffuser, 2x mounting clips per metre + 2x end caps per length	IP20	3 metres
HV9691-3030-3M	3m Length includes aluminium, diffuser + 6x end caps & 6x mounting clips	IP20	3 metres

SAMPLE INSTALLATION METHOD

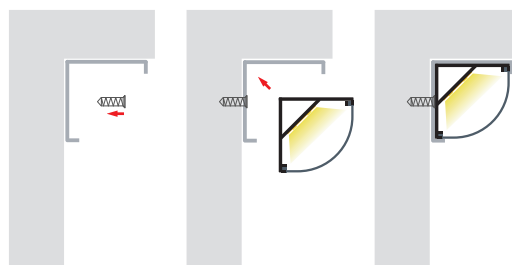

For detailed product specifications visit www.Havit.com.au or scan this QR code

Wardrobe LED Profile

- For use in wardrobes
- UV Stabilised PC diffuser
- Max Weight 10kg per metre

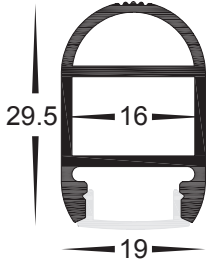

PROFILE & STRIP COMPATIBILITY

Scan to view all compatible LED Strip models
www.havit.com.au/PCC



PART NUMBER	DESCRIPTION	IP RATING	MAX LENGTH
HV9692-1930	Wardrobe Aluminium Profile with PC Diffuser - Kit - / Metre. Custom Cut Length. Supplied with Aluminium, Diffuser, 1 x centre rod per metre + 2x end caps per length	IP20	3 metres
HV9692-1930-3M	3m length includes aluminium, diffuser, 6x end caps and 3x centre rods	IP20	3 metres

HAVIT COMPATIBLE ACCESSORIES



HV9692-1930-CR: Centre mounting rod to suit HV9692-1930

SAMPLE INSTALLATION METHOD

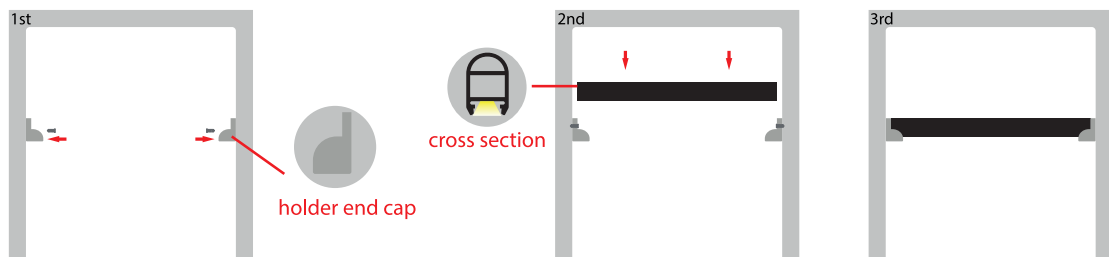

Micro Square LED Profile

- Micro square profile
- UV Stabilised PC diffuser

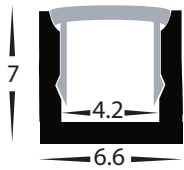

PROFILE & STRIP COMPATIBILITY

Scan to view all compatible LED Strip models
www.havit.com.au/PCC



PART NUMBER	DESCRIPTION	IP RATING	MAX LENGTH
HV9693-0607	Shallow Square Aluminium Profile with PC Diffuser - Kit - / Metre. Custom Cut Length. Supplied with Aluminium, Diffuser, 2x mounting clips per metre + 2x end caps per length	IP20	3 metres
HV9693-0607-3M	3m Length includes aluminium, diffuser + 6x end caps & 6x mounting clips	IP20	3 metres

SAMPLE INSTALLATION METHOD

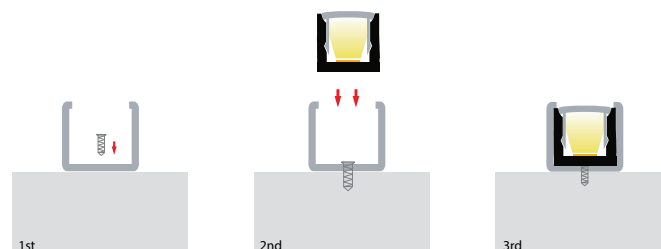

For detailed product specifications visit www.Havit.com.au or scan this QR code

Square LED Profile

- Square profile
- UV Stabilised PC diffuser

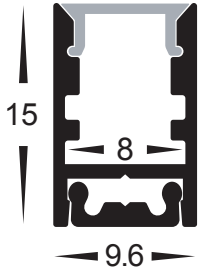

PROFILE & STRIP COMPATIBILITY

Scan to view all compatible
LED Strip models
www.havit.com.au/PCC



PART NUMBER	DESCRIPTION	IP RATING	MAX LENGTH
HV9693-0915	9mm x 15mm Square profile with PC diffuser. Custom Cut Length. Supplied with Aluminium, Diffuser + 2x end caps per length	IP20	3 metres
HV9693-0915-3M	3m Length includes aluminium, diffuser + 6x end caps	IP20	3 metres

SAMPLE INSTALLATION METHOD

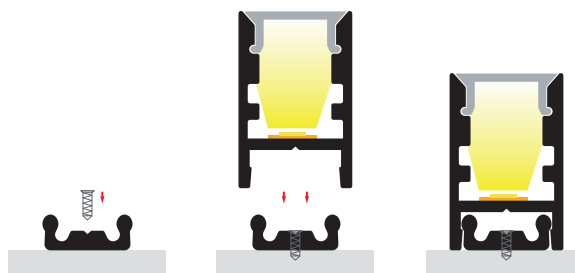

Slim Square LED Profile

- Slim Square Profile
- UV Stabilised PC Diffuser

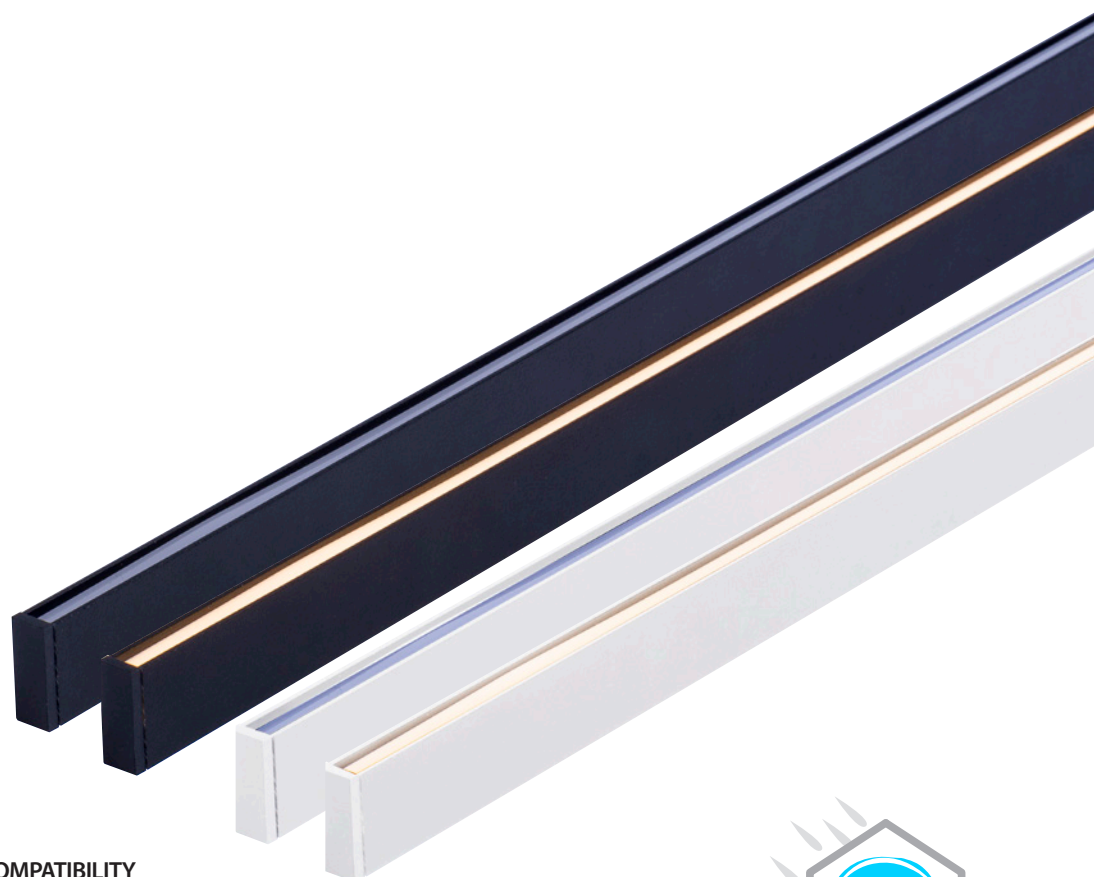
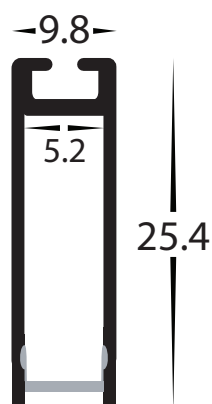

PROFILE & STRIP COMPATIBILITY

Scan to view all compatible LED Strip models
www.havit.com.au/PCC



PART NUMBER	DESCRIPTION	IP RATING	MAX LENGTH
HV9693-1045-BLK	Black Slim Square Aluminium Profile with PC Diffuser - Kit - / Metre. Custom Cut Length. Supplied with Aluminium, Diffuser + 2x end caps per length	IP20	3 metres
HV9693-1045-BLK-3M	3m Length includes aluminium, diffuser + 6x end caps	IP20	3 metres
HV9693-1045-WHT	White Slim Square Aluminium Profile with PC Diffuser - Kit - / Metre. Custom Cut Length. Supplied with Aluminium, Diffuser + 2x end caps per length	IP20	3 metres
HV9693-1045-WHT-3M	3m Length includes aluminium, diffuser + 6x end caps	IP20	3 metres

HAVIT COMPATIBLE ACCESSORIES



HV9693-1045-SUSKIT: Optional suspension kit

SAMPLE INSTALLATION METHOD

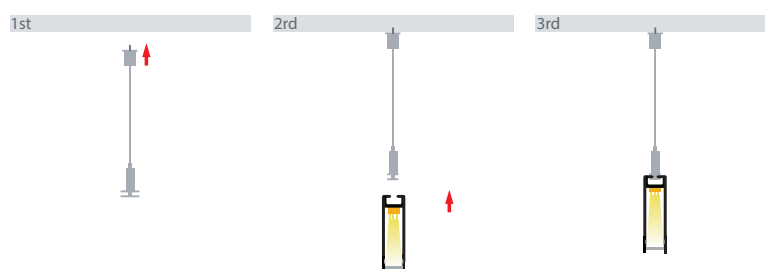

For detailed product specifications
 visit www.Havit.com.au
 or scan this QR code

Slim Square LED Profile

- Slim Square Profile
- UV Stabilised PC Diffuser

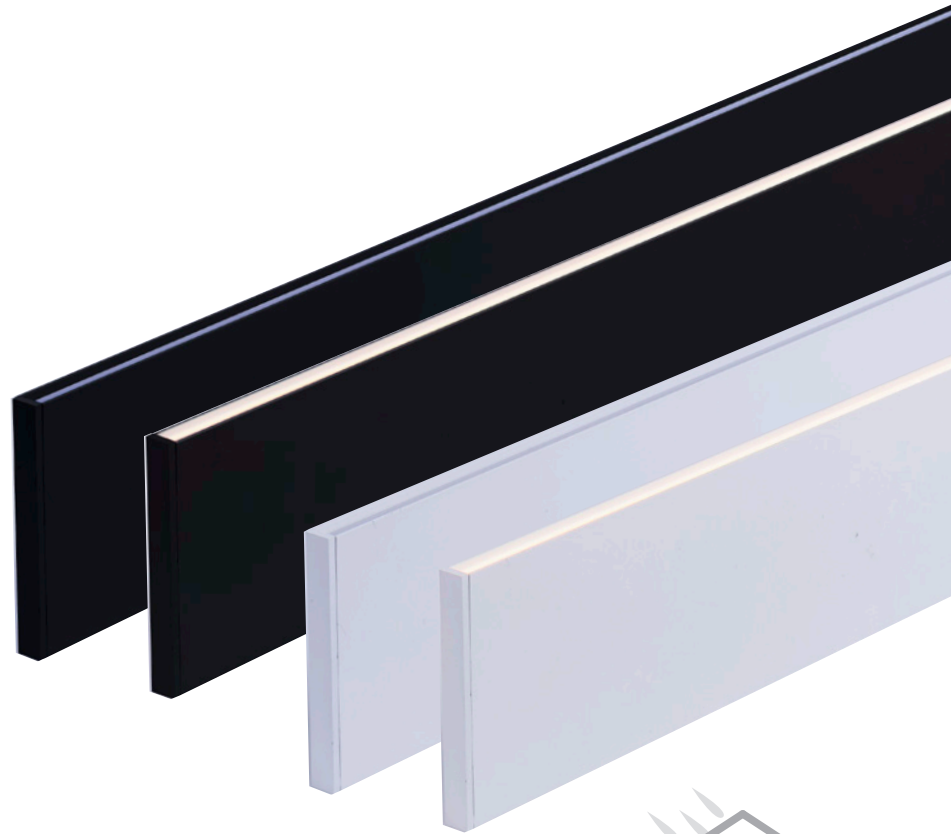
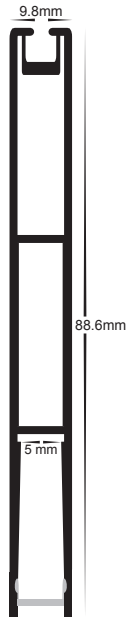

PROFILE & STRIP COMPATIBILITY

Scan to view all compatible LED Strip models
www.havit.com.au/PCC



PART NUMBER	DESCRIPTION	IP RATING	MAX LENGTH
HV9693-1089-BLK	Black Slim Aluminium Square profile with PC diffuser Kit - / Metre. Custom Cut Length. Supplied with Aluminium, Diffuser + 2x end caps per length	IP20	3 metres
HV9693-1089-BLK-3M	3m Length includes aluminium, diffuser + 6x end caps	IP20	3 metres
HV9693-1089-WHT	White Slim Aluminium Square profile with PC diffuser Kit - / Metre. Custom Cut Length. Supplied with Aluminium, Diffuser + 2x end caps per length	IP20	3 metres
HV9693-1089-WHT-3M	3m Length includes aluminium, diffuser + 6x end caps	IP20	3 metres

HAVIT COMPATIBLE ACCESSORIES



HV9693-1089-SUSKIT: Optional suspension kit

SAMPLE INSTALLATION METHOD

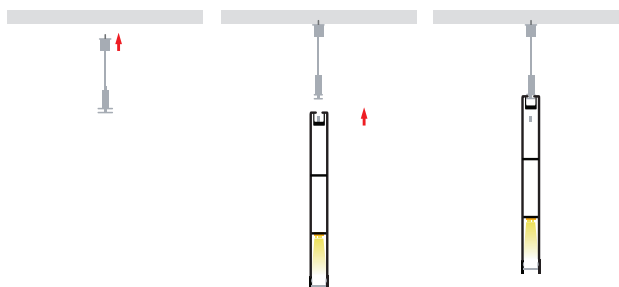

Square LED Profile

- Shallow square profile
- UV Stabilised PC diffuser

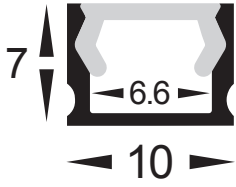

PROFILE & STRIP COMPATIBILITY

Scan to view all compatible LED Strip models
www.havit.com.au/PCC



PART NUMBER	DESCRIPTION	IP RATING	MAX LENGTH
HV9693-1007	Shallow Square Aluminium Profile with PC Diffuser - Kit - / Metre. Custom Cut Length. Supplied with Aluminium, Diffuser, 2x mounting clips per metre + 2x end caps per length	IP20	3 metres
HV9693-1007-3M	3m Length includes aluminium, diffuser + 6x end caps & 6x mounting clips	IP20	3 metres

SAMPLE INSTALLATION METHOD

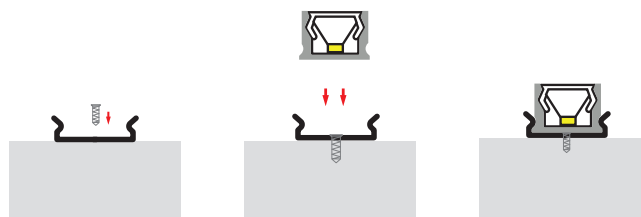

For detailed product specifications visit www.Havit.com.au or scan this QR code

Square LED Profile

- Shallow square profile
- UV Stabilised PC diffuser

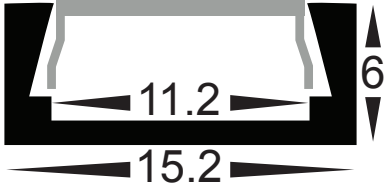

PROFILE & STRIP COMPATIBILITY

Scan to view all compatible LED Strip models
www.havit.com.au/PCC



PART NUMBER	DESCRIPTION	IP RATING	MAX LENGTH
HV9693-1506	Shallow Square Aluminium Profile with PC Diffuser - Kit - / Metre. Custom Cut Length. Supplied with Aluminium, Diffuser, 2x mounting clips per metre + 2x end caps per length	IP20	3 metres
HV9693-1506-3M	3m Length includes aluminium, diffuser + 6x end caps & 6x mounting clips	IP20	3 metres

HAVIT COMPATIBLE ACCESSORIES



HV9693-1506-SD-ROLL: Diffuser available for continuous run of up to 20 metres

SAMPLE INSTALLATION METHOD

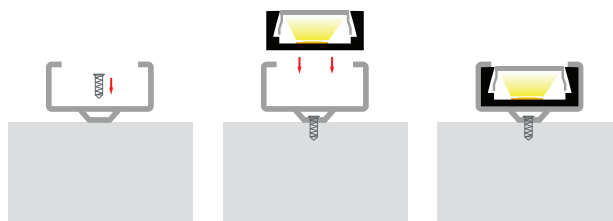

Square LED Profile

- Shallow square profile
- UV Stabilised PC diffuser

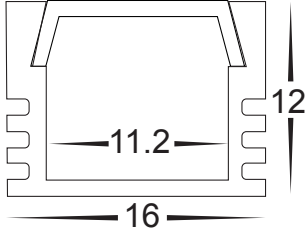

PROFILE & STRIP COMPATIBILITY

Scan to view all compatible LED Strip models
www.havit.com.au/PCC



PART NUMBER	DESCRIPTION	IP RATING	MAX LENGTH
HV9693-1612	Shallow Square Aluminium Profile with PC Diffuser - Kit - / Metre. Custom Cut Length. Supplied with Aluminium, Diffuser, 2x mounting clips per metre + 2x end caps per length	IP20	3 metres
HV9693-1612-3M	3m Length includes aluminium, diffuser + 6x end caps & 6x mounting clips	IP20	3 metres
HV9693-1612-BLK	Black Shallow Square Aluminium Profile with PC Diffuser - Kit - / Metre. Custom Cut Length. Supplied with Black Aluminium, Diffuser, 2x mounting clips per metre + 2x end caps per length	IP20	3 metres
HV9693-1612-BLK-3M	3m Length includes aluminium, diffuser + 6x end caps & 6x mounting clips	IP20	3 metres
HV9693-1612-WHT	White Shallow Square Aluminium Profile with PC Diffuser - Kit - / Metre. Custom Cut Length. Supplied with White Aluminium, Diffuser, 2x mounting clips per metre + 2x end caps per length	IP20	3 metres
HV9693-1612-WHT-3M	3m Length includes aluminium, diffuser + 6x end caps & 6x mounting clips	IP20	3 metres

HAVIT COMPATIBLE ACCESSORIES



HV9693-1612-SD-ROLL: Diffuser available for continuous run of up to 20 metres



HV9693-1612-BLKSD: Black diffuser to suit HV9693-1612 up to 3m length

SAMPLE INSTALLATION METHOD

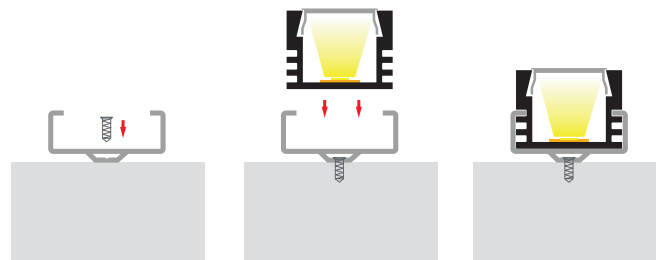

For detailed product specifications visit www.Havit.com.au or scan this QR code

Square LED Profile

- Shallow square profile
- Anti glare design
- UV Stabilised diffuser

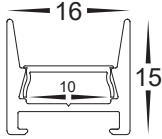
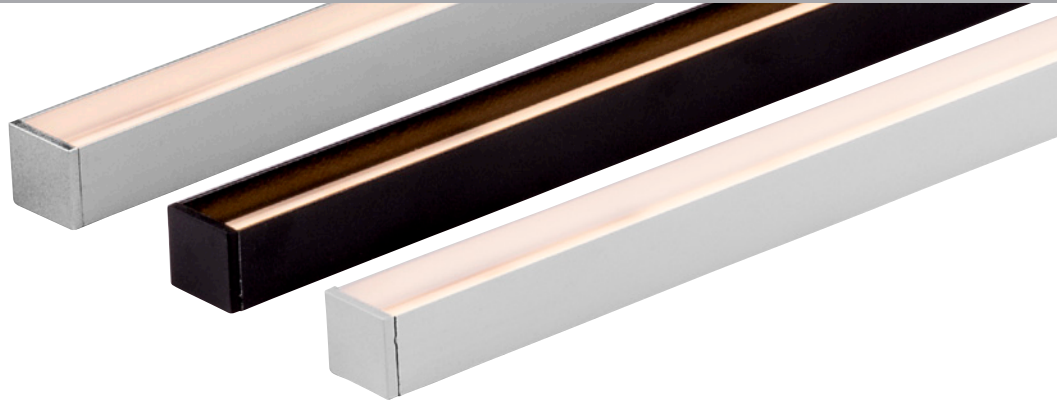







PROFILE & STRIP COMPATIBILITY

Scan to view all compatible LED Strip models
www.havit.com.au/PCC



PART NUMBER	DESCRIPTION	IP RATING	MAX LENGTH
HV9693-1615	Shallow Square Aluminium Profile with PC Diffuser - Kit - /Metre. Custom Cut Length Supplied with Aluminium, Diffuser, 2x mounting clips per metre + 2x end caps per length"	IP20	3 metres
HV9693-1615-3M	3m Length includes aluminium, diffuser + 6x end caps & 6x mounting clips	IP20	3 metres
HV9693-1615-BLK	Black Shallow Square Aluminium Profile with PC Diffuser - Kit - /Metre. Custom Cut Length Supplied with Aluminium, Diffuser, 2x mounting clips per metre + 2x end caps per length	IP20	3 metres
HV9693-1615-BLK-3M	3m Length includes aluminium, diffuser + 6x end caps & 6x mounting clips	IP20	3 metres
HV9693-1615-WHT	White Shallow Square Aluminium Profile with PC Diffuser - Kit - /Metre. Custom Cut Length Supplied with Aluminium, Diffuser, 2x mounting clips per metre + 2x end caps per length	IP20	3 metres
HV9693-1615-WHT-3M	3m Length includes aluminium, diffuser + 6x end caps & 6x mounting clips	IP20	3 metres

HAVIT COMPATIBLE ACCESSORIES

	HV9693-1615-SD-ROLL: Diffuser available for continuous run of up to 20 metres
	HV9693-1615-BLKSD: Black diffuser to suit up to 3m length
	HV9693-1615-JOINER: Straight Joiner
	HV9693-1615-LJOINER: L-Shape Joiner
	HV9693-1615-VJOINER: Vertical Joiner
	HV9693-1615-MGC: Magnetic mounting clips

SAMPLE INSTALLATION METHOD

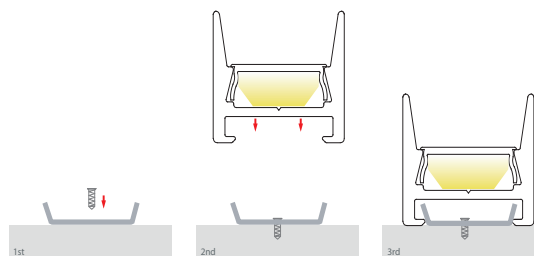

Square LED Profile

- Shallow square profile
- UV Stabilised PC diffuser

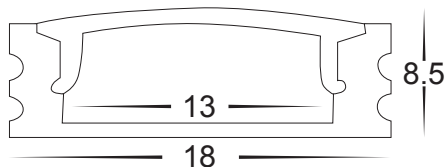



PROFILE & STRIP COMPATIBILITY

Scan to view all compatible LED Strip models
www.havit.com.au/PCC



PART NUMBER	DESCRIPTION	IP RATING	MAX LENGTH
HV9693-1707	18mm x 9mm Shallow square profile with PC diffuser - Kit - / Metre. Custom Cut Length. Supplied with Aluminium, Diffuser, 2x mounting clips per metre + 2x end caps per length	IP20	3 metres
HV9693-1707-3M	3m Length includes aluminium, diffuser + 6x end caps & 6x mounting clips	IP20	3 metres
HV9693-1707-BLK	18mm x 9mm Black shallow square profile with PC diffuser - Kit - / Metre. Custom Cut Length. Supplied with Black Aluminium, Diffuser, 2x mounting clips per metre + 2x end caps per length	IP20	3 metres
HV9693-1707-BLK-3M	3m Length includes aluminium, diffuser + 6x end caps & 6x mounting clips	IP20	3 metres
HV9693-1707-WHT	18mm x 9mm White shallow square profile with PC diffuser - Kit - / Metre. Custom Cut Length. Supplied with White Aluminium, Diffuser, 2x mounting clips per metre + 2x end caps per length	IP20	3 metres
HV9693-1707-WHT-3M	3m Length includes aluminium, diffuser + 6x end caps & 6x mounting clips	IP20	3 metres

HAVIT COMPATIBLE ACCESSORIES

	HV9693-1707-SD-ROLL: Diffuser available for continuous run of up to 20 metres
	HV9693-1707-BLKSD: Black diffuser to suit HV9693-1707 up to 3m length

SAMPLE INSTALLATION METHOD

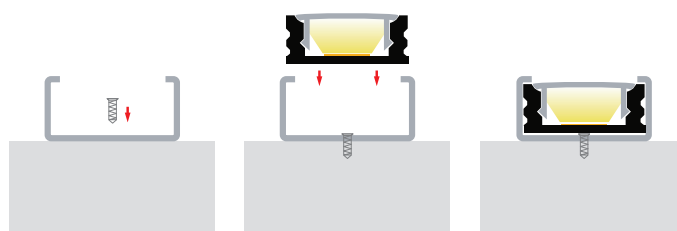

For detailed product specifications visit www.Havit.com.au or scan this QR code

Square LED Profile

- Shallow square profile
- Anti glare design
- UV Stabilised diffuser

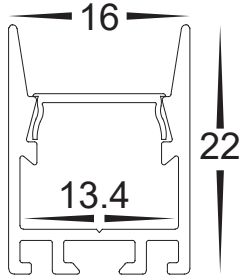



PROFILE & STRIP COMPATIBILITY

Scan to view all compatible LED Strip models
www.havit.com.au/PCC



PART NUMBER	DESCRIPTION	IP RATING	MAX LENGTH
HV9693-1622	Shallow Square Aluminium Profile with PC Diffuser - Kit - /Metre. Custom Cut Length Supplied with Aluminium, Diffuser + 2x end caps per length	IP20	3 metres
HV9693-1622-3M	3m Length includes aluminium, diffuser + 6x end caps	IP20	3 metres
HV9693-1622-BLK	Black Shallow Square Aluminium Profile with PC Diffuser - Kit - /Metre. Custom Cut Length Supplied with Aluminium, Diffuser + 2x end caps per length	IP20	3 metres
HV9693-1622-BLK-3M	3m Length includes aluminium, diffuser + 6x end caps	IP20	3 metres
HV9693-1622-WHT	"White Shallow Square Aluminium Profile with PC Diffuser - Kit - /Metre. Custom Cut Length Supplied with Aluminium, Diffuser + 2x end caps per length	IP20	3 metres
HV9693-1622-WHT-3M	3m Length includes aluminium, diffuser + 6x end caps	IP20	3 metres

HAVIT COMPATIBLE ACCESSORIES

	HV9693-1622-SD-ROLL: Diffuser available for continuous run of up to 20 metres
	HV9693-1622-BLKSD: Black diffuser to suit up to 3m length
	HV9705-9950: Optional suspension kit

SAMPLE INSTALLATION METHOD

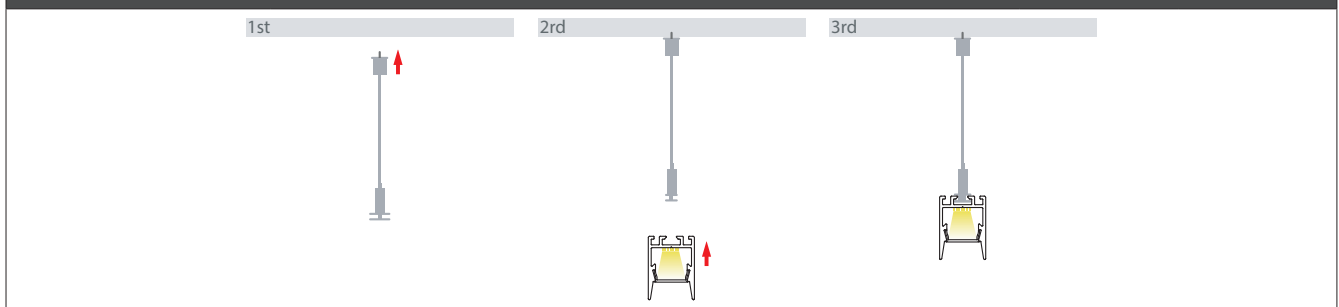

Bendable LED Profile

- Shallow square profile
- UV Stabilised PC diffuser
- Can be bent in both directions

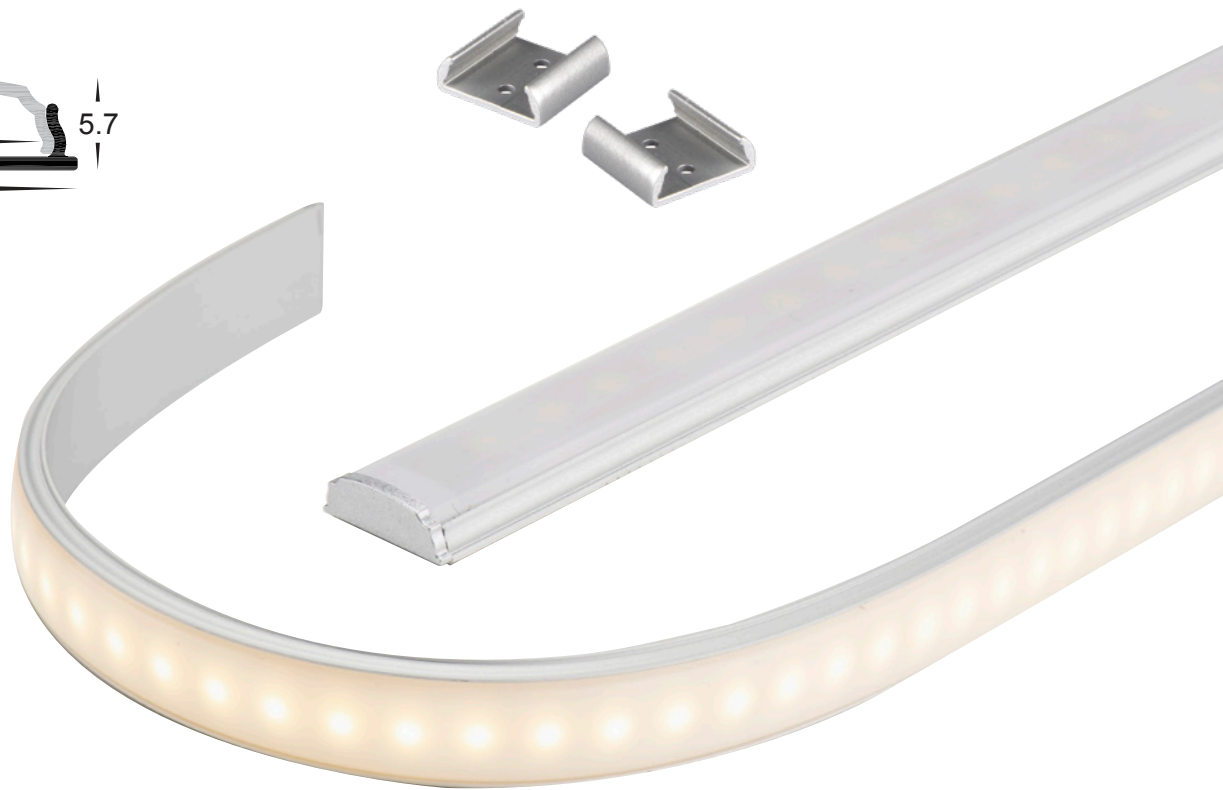
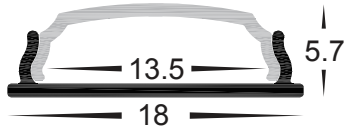

PROFILE & STRIP COMPATIBILITY

Scan to view all compatible LED Strip models
www.havit.com.au/PCC



PART NUMBER	DESCRIPTION	IP RATING	MAX LENGTH
HV9693-1806	Shallow Square Bendable Aluminium Profile with PC Diffuser - Kit - / Metre. Custom Cut Length. Supplied with Aluminium, Diffuser, 2x mounting clips per metre + 2x end caps per length	IP20	3 metres
HV9693-1806 -3M	3m Length includes aluminium, diffuser + 6x end caps & 6x mounting clips	IP20	3 metres

HAVIT COMPATIBLE ACCESSORIES



HV9693-1806-SD-ROLL: Diffuser available for continuous run of up to 20 metres

SAMPLE INSTALLATION METHOD

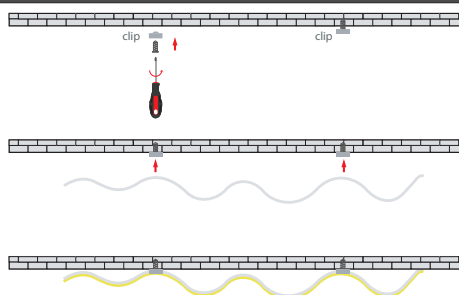

For detailed product specifications visit www.Havit.com.au or scan this QR code

IP65 Rated Square LED Profile

- Shallow square profile
- UV Stabilised PC diffuser
- Profile can only be installed using supplied mounting clips

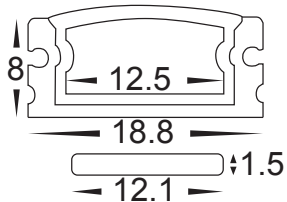

PROFILE & STRIP COMPATIBILITY

Scan to view all compatible LED Strip models
www.havit.com.au/PCC



PART NUMBER	DESCRIPTION	IP RATING	MAX LENGTH
HV9693-1808	Shallow Square Aluminium Profile with PC Diffuser - Kit - / Metre. Custom Cut Length. Supplied with Aluminium, Diffuser + 2x end caps and seals per length	IP65	3 metres
HV9693-1808-3M	3m Length includes aluminium, diffuser + 6x end caps & 6x mounting clips	IP65	3 metres

SAMPLE INSTALLATION METHOD

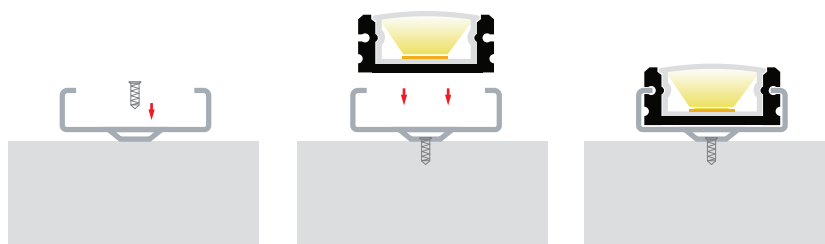

IP65 Rated Square LED Profile

- Shallow square profile
- UV Stabilised PC diffuser
- Profile can only be installed using supplied mounting clips

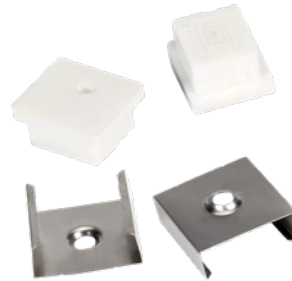
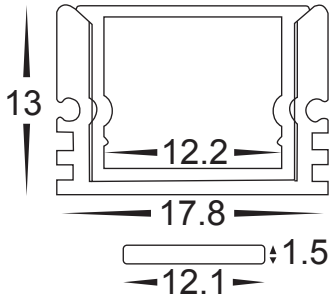

PROFILE & STRIP COMPATIBILITY
Scan to view all compatible LED Strip models
www.havit.com.au/PCC



PART NUMBER	DESCRIPTION	IP RATING	MAX LENGTH
HV9693-1812	Shallow Square Aluminium Profile with PC Diffuser - Kit - / Metre. Custom Cut Length. Supplied with Aluminium, Diffuser + 2x end caps and seals per length	IP65	3 metres
HV9693-1812-3M	3m Length includes aluminium, diffuser + 6x end caps & 6x mounting clips	IP65	3 metres

SAMPLE INSTALLATION METHOD

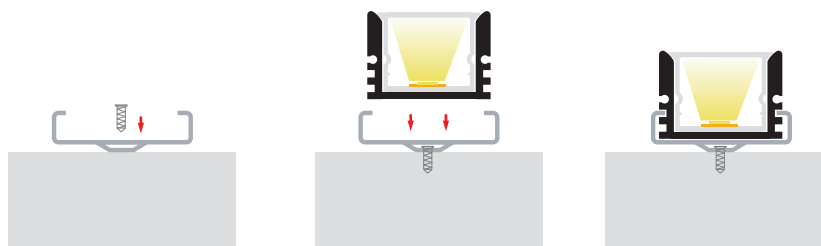

For detailed product specifications visit www.Havit.com.au or scan this QR code

Square LED Profile

- Deep square profile
- UV Stabilised PC diffuser

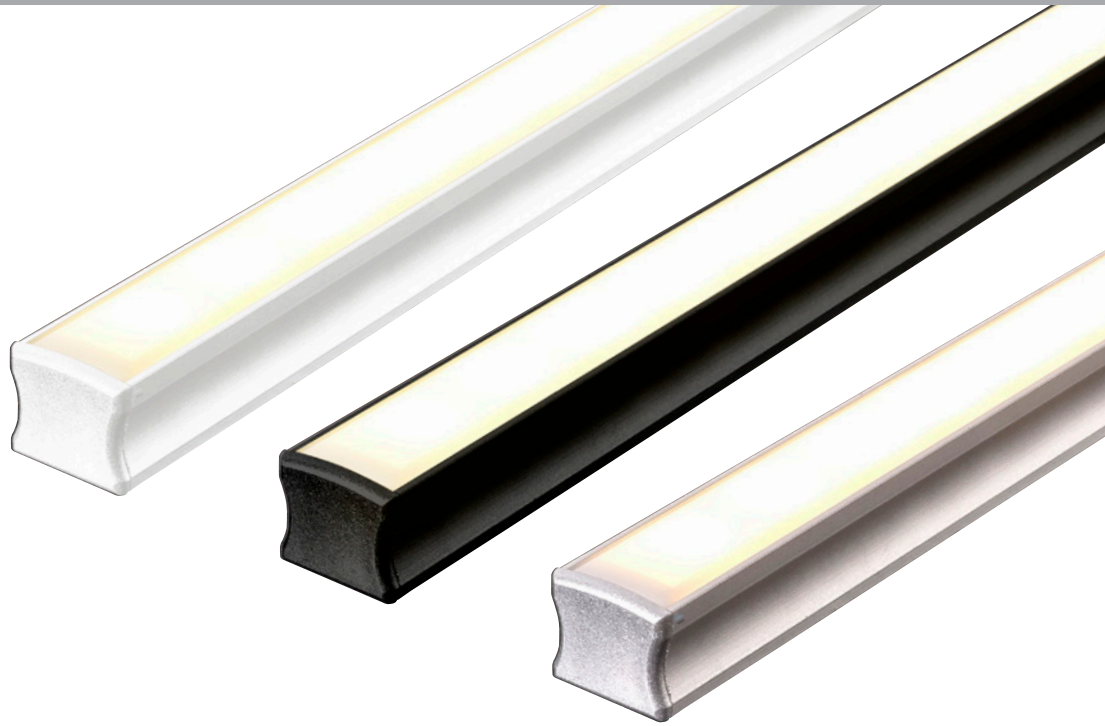
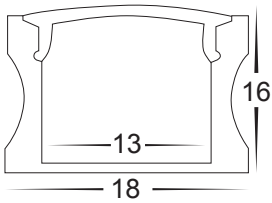



PROFILE & STRIP COMPATIBILITY

Scan to view all compatible LED Strip models
www.havit.com.au/PCC



PART NUMBER	DESCRIPTION	IP RATING	MAX LENGTH
HV9693-1815	18mm x 15mm Deep square profile with PC diffuser - Kit - / Metre. Custom Cut Length. Supplied with Aluminium, Diffuser, 2x mounting clips per metre + 2x end caps per length	IP20	3 metres
HV9693-1815-3M	3m Length includes aluminium, diffuser + 6x end caps & 6x mounting clips	IP20	3 metres
HV9693-1815-BLK	18mm x 15mm Black Deep square profile with PC diffuser - Kit - / Metre. Custom Cut Length. Supplied with Black Aluminium, Diffuser, 2x mounting clips per metre + 2x end caps per length	IP20	3 metres
HV9693-1815-BLK-3M	3m Length includes aluminium, diffuser + 6x end caps & 6x mounting clips	IP20	3 metres
HV9693-1815-WHT	18mm x 15mm White Deep square profile with PC diffuser - Kit - / Metre. Custom Cut Length. Supplied with White Aluminium, Diffuser, 2x mounting clips per metre + 2x end caps per length	IP20	3 metres
HV9693-1815-WHT-3M	3m Length includes aluminium, diffuser + 6x end caps & 6x mounting clips	IP20	3 metres

HAVIT COMPATIBLE ACCESSORIES

	HV9693-1815-SD-ROLL: Diffuser available for continuous run of up to 20 metres
	HV9693-1815-BLKSD: Black diffuser to suit HV9693-1815 up to 3m length

SAMPLE INSTALLATION METHOD

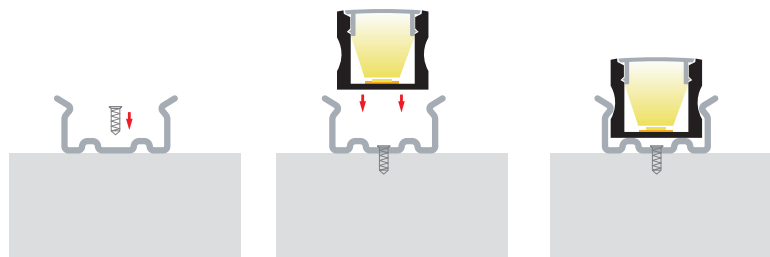

Slim Square LED Profile

- Slim Square Profile
- UV Stabilised PC Diffuser

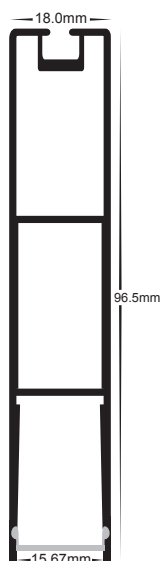



PROFILE & STRIP COMPATIBILITY

Scan to view all compatible LED Strip models
www.havit.com.au/PCC



PART NUMBER	DESCRIPTION	IP RATING	MAX LENGTH
HV9693-1896-BLK	Black Slim Deep square profile with PC diffuser - Kit - / Metre. Custom Cut Length. Supplied with Black Aluminium, Diffuser + 2x end caps per length	IP20	3 metres
HV9693-1896-BLK-3M	3m Length includes aluminium, diffuser + 6x end caps	IP20	3 metres
HV9693-1896-WHT	White Slim Deep square profile with PC diffuser - Kit - / Metre. Custom Cut Length. Supplied with White Aluminium, Diffuser + 2x end caps per length	IP20	3 metres
HV9693-1896-WHT-3M	3m Length includes aluminium, diffuser + 6x end caps	IP20	3 metres

HAVIT COMPATIBLE ACCESSORIES

	HV9693-1896-BLKSD: Black diffuser to suit HV9693-1896 up to 3m length
	HV9693-1896-SUSKIT: Optional suspension kit

SAMPLE INSTALLATION METHOD

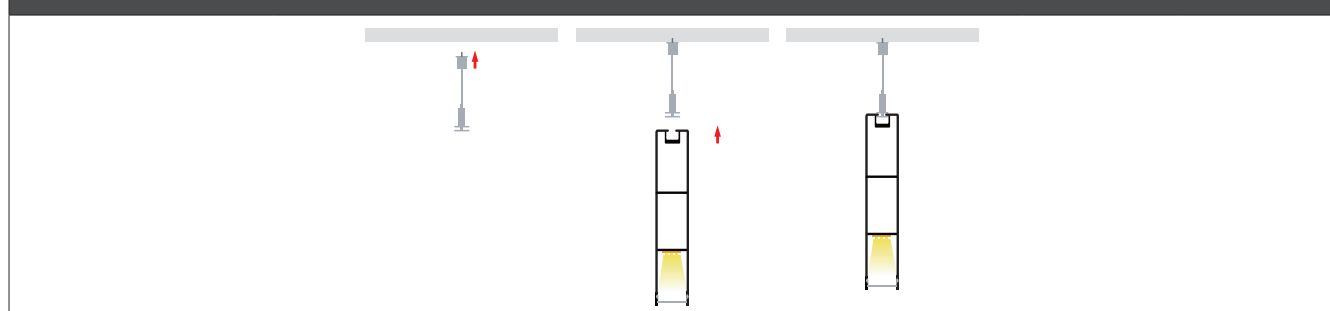

For detailed product specifications visit www.Havit.com.au or scan this QR code

Square LED Profile

- Deep square profile
- UV Stabilised PC diffuser
- Supplied with aluminium mounting bar

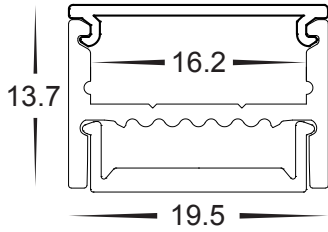

PROFILE & STRIP COMPATIBILITY
 Scan to view all compatible
 LED Strip models
www.havit.com.au/PCC



PART NUMBER	DESCRIPTION	IP RATING	MAX LENGTH
HV9693-1922	19mm x 14mm Deep square profile with PC diffuser - Kit - / Metre. Custom Cut Length. Supplied with Aluminium, Diffuser + 2x end caps per length	IP20	3 metres
HV9693-1922-3M	3m Length includes aluminium, diffuser + 6x end caps	IP20	3 metres

SAMPLE INSTALLATION METHOD

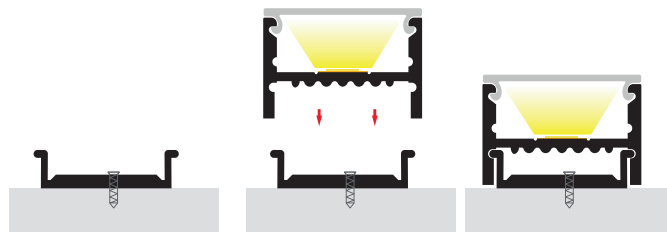

Deep Diffuser LED Profile

- Square Profile with Deep Diffuser
- UV Stabilised PC Diffuser

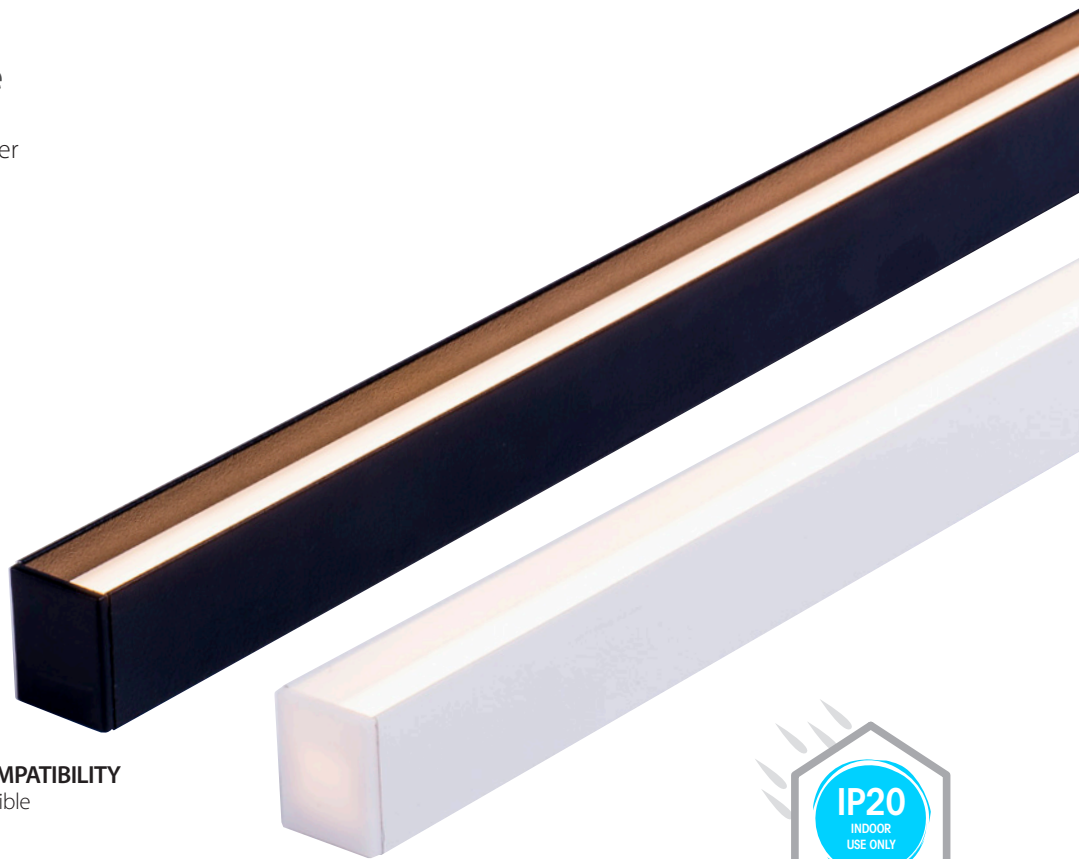
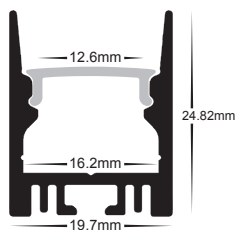





PROFILE & STRIP COMPATIBILITY

Scan to view all compatible LED Strip models
www.havit.com.au/PCC



PART NUMBER	DESCRIPTION	IP RATING	MAX LENGTH
HV9693-2025-BLK	Black square profile with PC diffuser - Kit - / Metre. Custom Cut Length. Supplied with Black Aluminium, Diffuser + 2x end caps per length	IP20	3 metres
HV9693-2025-BLK-3M	3m Length includes aluminium, diffuser + 6x end caps	IP20	3 metres
HV9693-2025-WHT	White square profile with PC diffuser - Kit - / Metre. Custom Cut Length. Supplied with White Aluminium, Diffuser + 2x end caps per length	IP20	3 metres
HV9693-2025-WHT-3M	3m Length includes aluminium, diffuser + 6x end caps	IP20	3 metres

HAVIT COMPATIBLE ACCESSORIES

	HV9693-2025-SD-ROLL: Diffuser available for continuous run of up to 20 metres
	HV9693-2025-BLKSD: Black diffuser to suit HV9693-2025 up to 3m length
	HV9693-2025-SUSKIT: Optional suspension kit
	HV9693-2025-SMCLIP: Optional surface mount clip

SAMPLE INSTALLATION METHOD

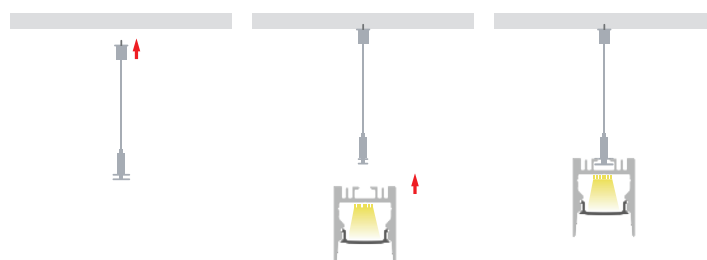

For detailed product specifications visit www.Havit.com.au or scan this QR code

Square LED Profile

- Deep Square aluminium profile
- UV Stabilised PC Diffuser

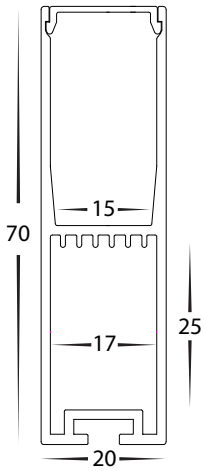



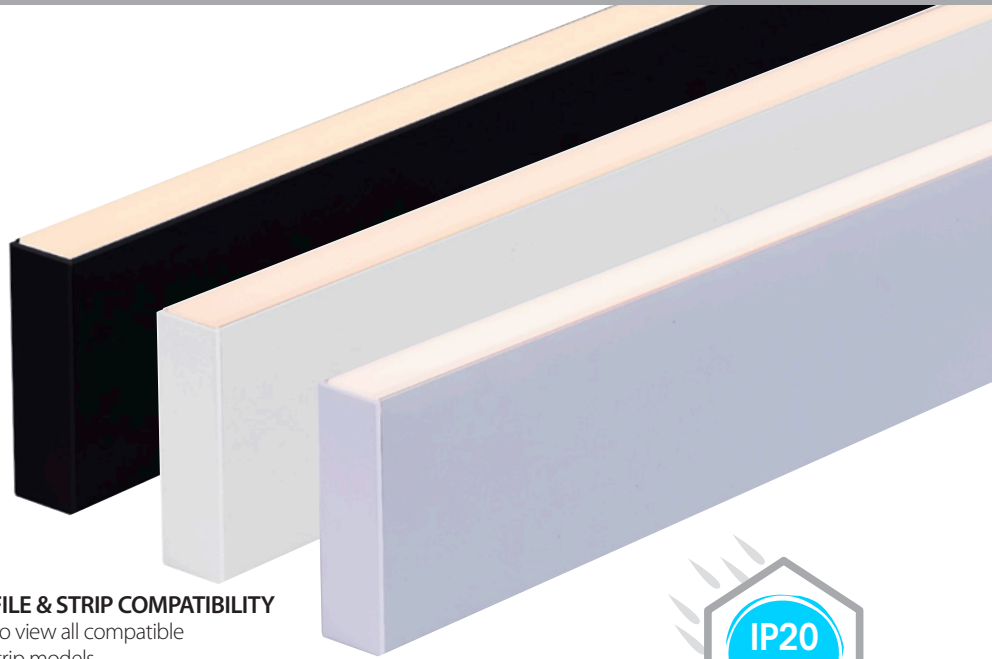



PROFILE & STRIP COMPATIBILITY
Scan to view all compatible LED Strip models
www.havit.com.au/PCC



PART NUMBER	DESCRIPTION	IP RATING	MAX LENGTH
HV9693-2070	Deep Square Aluminium Profile with PC Diffuser - Kit - / Metre. Custom Cut Length. Supplied with Aluminium, Diffuser + 2x end caps per length	IP20	3 metres
HV9693-2070-3M	3m Length includes aluminium, diffuser + 6x end caps	IP20	3 metres
HV9693-2070-BLK	Black Deep Square Aluminium Profile with PC Diffuser - Kit - / Metre. Custom Cut Length. Supplied with Aluminium, Diffuser + 2x end caps per length	IP20	3 metres
HV9693-2070-BLK-3M	3m Length includes aluminium, diffuser + 6x end caps	IP20	3 metres
HV9693-2070-WHT	White Deep Square Aluminium Profile with PC Diffuser - Kit - / Metre. Custom Cut Length. Supplied with Aluminium, Diffuser + 2x end caps per length	IP20	3 metres
HV9693-2070-WHT-3M	3m Length includes aluminium, diffuser + 6x end caps	IP20	3 metres

HAVIT COMPATIBLE ACCESSORIES

	HV9693-2070-SD-ROLL: Diffuser available for continuous run of up to 20 metres
	HV9693-2070-BLKSD: Black diffuser to suit HV9693-2070 up to 3m length
	HV9693-2070-JOINER: Joiner kit to allow multiple lengths to be joined to form a continuous run.
	HV9705-9953: Optional suspension kit
	HV9705-9953-BLK
	HV9705-9953-WHT

SAMPLE INSTALLATION METHOD

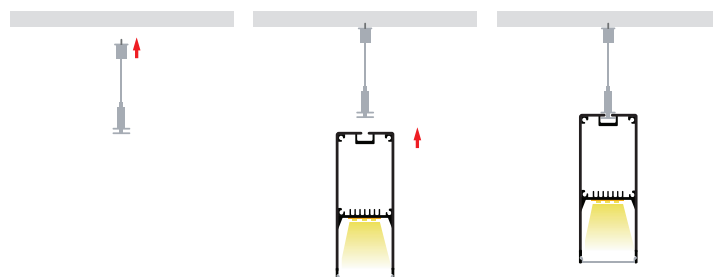

Square LED Profile

- Shallow square profile with square diffuser
- UV Stabilised PC diffuser

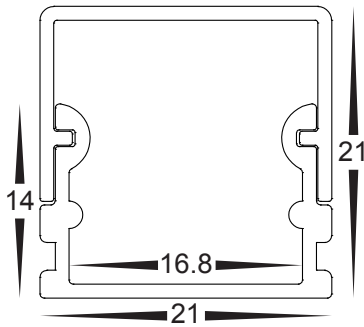

PROFILE & STRIP COMPATIBILITY
Scan to view all compatible LED Strip models
www.havit.com.au/PCC



PART NUMBER	DESCRIPTION	IP RATING	MAX LENGTH
HV9693-2114	21mm x 21mm Deep square profile with square diffuser - Kit - / Metre. Custom Cut Length. Supplied with Aluminium, Diffuser, 2x mounting clips per metre + 2x end caps per length	IP20	3 metres
HV9693-2114-3M	3m Length includes aluminium, diffuser + 6x end caps & 6x mounting clips	IP20	3 metres

SAMPLE INSTALLATION METHOD

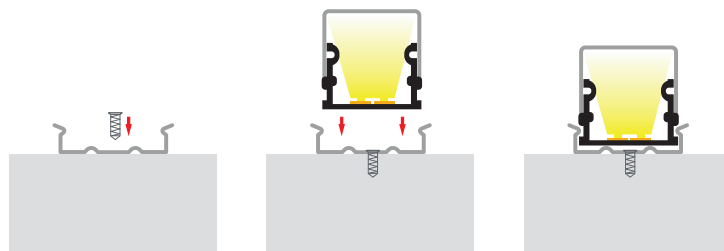

For detailed product specifications visit www.Havit.com.au or scan this QR code

Square LED Profile

- Shallow double square profile
- UV Stabilised PC diffuser

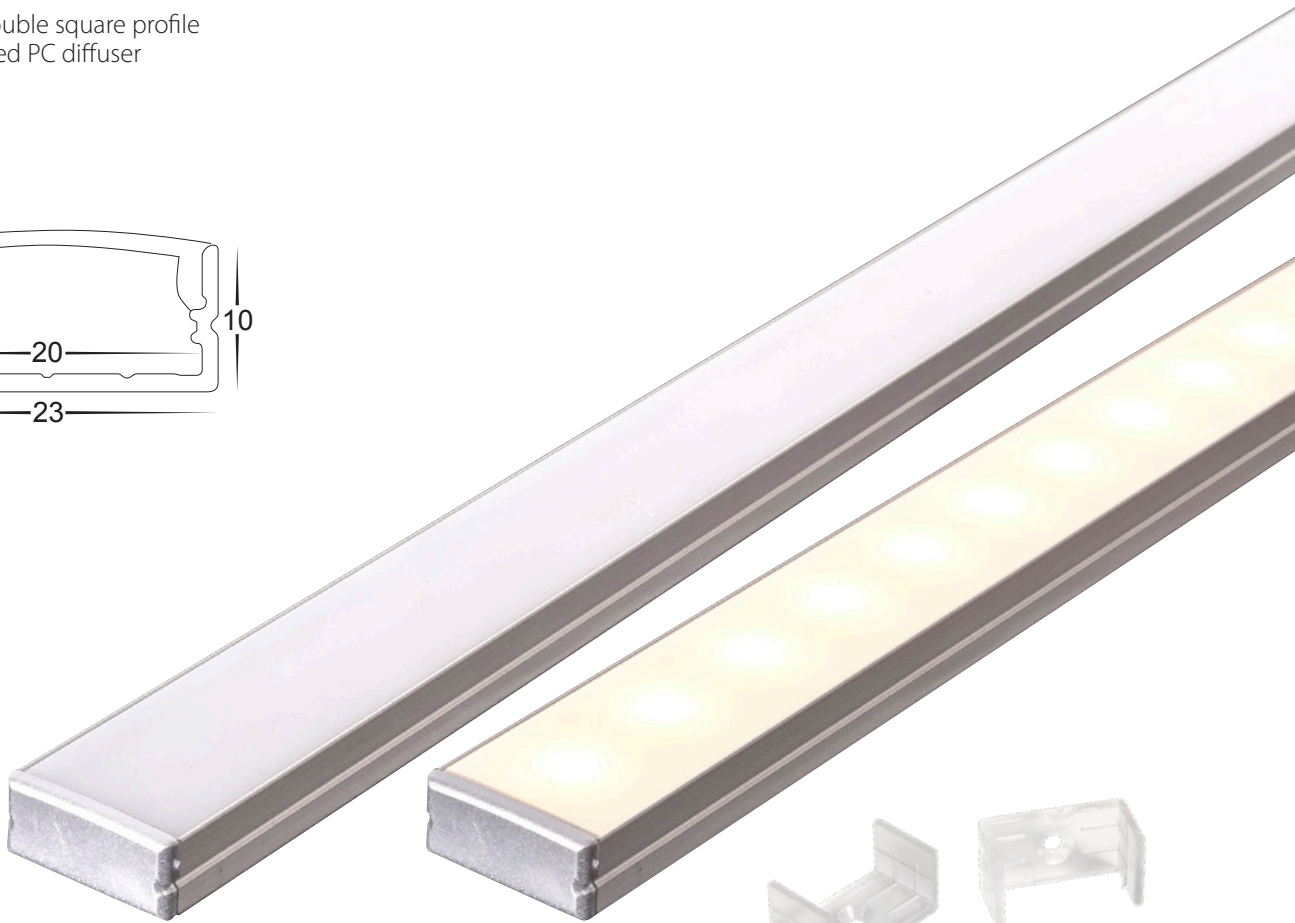
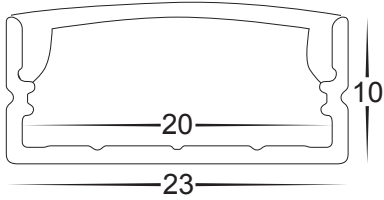

PROFILE & STRIP COMPATIBILITY
 Scan to view all compatible
 LED Strip models
www.havit.com.au/PCC



PART NUMBER	DESCRIPTION	IP RATING	MAX LENGTH
HV9693-2310	23mm x 10mm Shallow double square profile with PC diffuser - Kit - / Metre. Custom Cut Length. Supplied with Aluminium, Diffuser, 2x mounting clips per metre + 2x end caps per length	IP20	3 metres
HV9693-2310-3M	3m Length includes aluminium, diffuser + 6x end caps & 6x mounting clips	IP20	3 metres

HAVIT COMPATIBLE ACCESSORIES



HV9693-2310-SD-ROLL: Diffuser available for continuous run of up to 20 metres

SAMPLE INSTALLATION METHOD

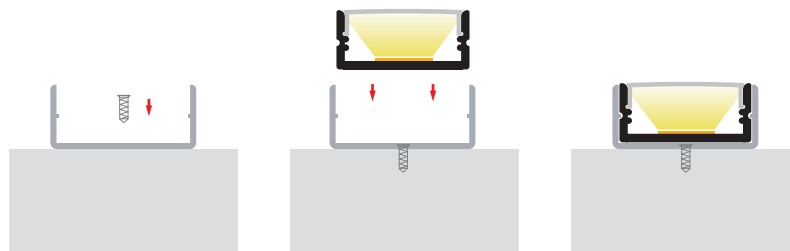

Square LED Profile

- Deep square profile
- UV Stabilised PC diffuser

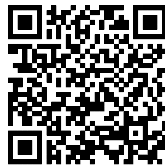
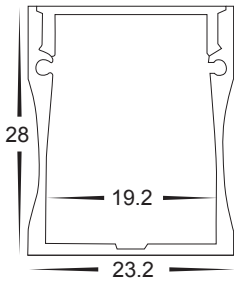

PROFILE & STRIP COMPATIBILITY

Scan to view all compatible LED Strip models
www.havit.com.au/PCC



PART NUMBER	DESCRIPTION	IP RATING	MAX LENGTH
HV9693-2320	23mm x 28mm Deep square profile with PC diffuser - Kit - / Metre. Custom Cut Length. Supplied with Aluminium, Diffuser + 2x end caps per length	IP20	3 metres
HV9693-2320-3M	3m Length includes aluminium, diffuser + 6x end caps	IP20	3 metres

HAVIT COMPATIBLE ACCESSORIES



HV9693-2320-SD-ROLL: Diffuser available for continuous run of up to 20 metres

SAMPLE INSTALLATION METHOD

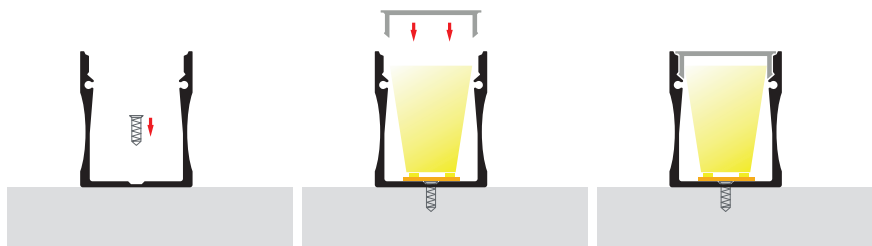

For detailed product specifications visit www.Havit.com.au or scan this QR code

Square LED Profile

- Shallow square profile
- Anti glare design
- UV Stabilised diffuser

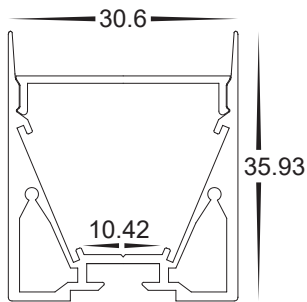





PROFILE & STRIP COMPATIBILITY

Scan to view all compatible LED Strip models
www.havit.com.au/PCC



PART NUMBER	DESCRIPTION	IP RATING	MAX LENGTH
HV9693-3136	Square Aluminium Profile with PC Diffuser - Kit - /Metre. Custom Cut Length Supplied with Aluminium, Diffuser + 2x end caps per length	IP20	3 metres
HV9693-3136-3M	3m Length includes aluminium, diffuser + 6x end caps	IP20	3 metres
HV9693-3136-BLK	Black Square Aluminium Profile with PC Diffuser - Kit - /Metre. Custom Cut Length Supplied with Aluminium, Diffuser + 2x end caps per length	IP20	3 metres
HV9693-3136-BLK-3M	3m Length includes aluminium, diffuser + 6x end caps	IP20	3 metres
HV9693-3136-WHT	White Square Aluminium Profile with PC Diffuser - Kit - /Metre. Custom Cut Length Supplied with Aluminium, Diffuser + 2x end caps per length	IP20	3 metres
HV9693-3136-WHT-3M	3m Length includes aluminium, diffuser + 6x end caps	IP20	3 metres

HAVIT COMPATIBLE ACCESSORIES

	HV9693-3136-SD-ROLL: Diffuser available for continuous run of up to 20 metres
	HV9693-3136-BLKSD: Black diffuser to suit up to 3m length
	HV9705-9953: Optional suspension kit
	HV9705-9953-BLK
	HV9705-9953-WHT

SAMPLE INSTALLATION METHOD

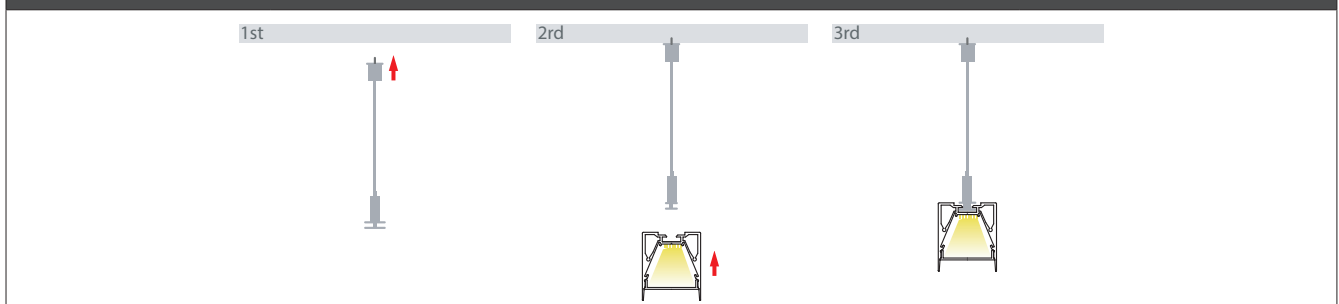

Square LED Profile



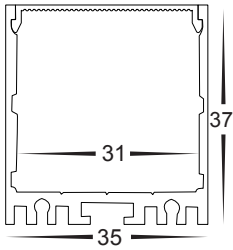



- Deep square profile
- UV Stabilised PC diffuser



PROFILE & STRIP COMPATIBILITY
Scan to view all compatible LED Strip models
www.havit.com.au/PCC

PART NUMBER	DESCRIPTION	IP RATING	MAX LENGTH
HV9693-3537	35mm x 37mm Deep square profile with PC diffuser - Kit - / Metre. Custom Cut Length. Supplied with Aluminium, Diffuser + 2x end caps per length	IP20	3 metres
HV9693-3537-3M	3m Length includes aluminium, diffuser + 6x end caps	IP20	3 metres
HV9693-3537-BLK	35mm x 37mm Black deep square profile with PC diffuser - Kit - / Metre. Custom Cut Length. Supplied with Black Aluminium, Diffuser + 2x end caps per length	IP20	3 metres
HV9693-3537-BLK-3M	3m Length includes aluminium, diffuser + 6x end caps	IP20	3 metres
HV9693-3537-WHT	35mm x 37mm White deep square profile with PC diffuser - Kit - / Metre. Custom Cut Length. Supplied with White Aluminium, Diffuser + 2x end caps per length	IP20	3 metres
HV9693-3537-WHT-3M	3m Length includes aluminium, diffuser + 6x end caps	IP20	3 metres

HAVIT COMPATIBLE ACCESSORIES

	HV9693-3537-SD-ROLL: Diffuser available for continuous run of up to 20 metres
	HV9693-3537-BLKSD: Black diffuser to suit HV9693-3537 up to 3m length
	HV9693-3537-JOINER: Joiner kit to allow multiple lengths to be joined to form a continuous run.
	HV9705-9953: Optional suspension kit
	HV9705-9953-BLK
	HV9705-9953-WHT

SAMPLE INSTALLATION METHOD

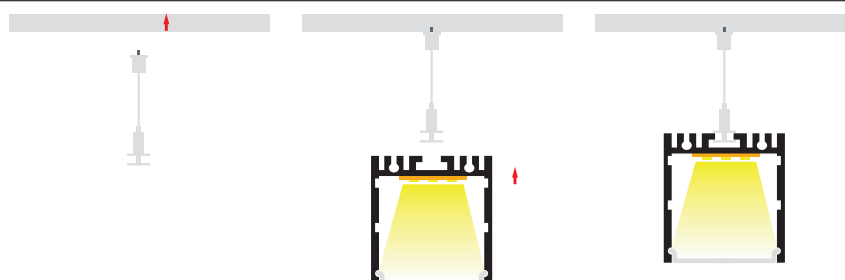

For detailed product specifications
visit www.Havit.com.au
or scan this QR code

Square LED Profile

- Large Deep square profile
- UV Stabilised PC diffuser

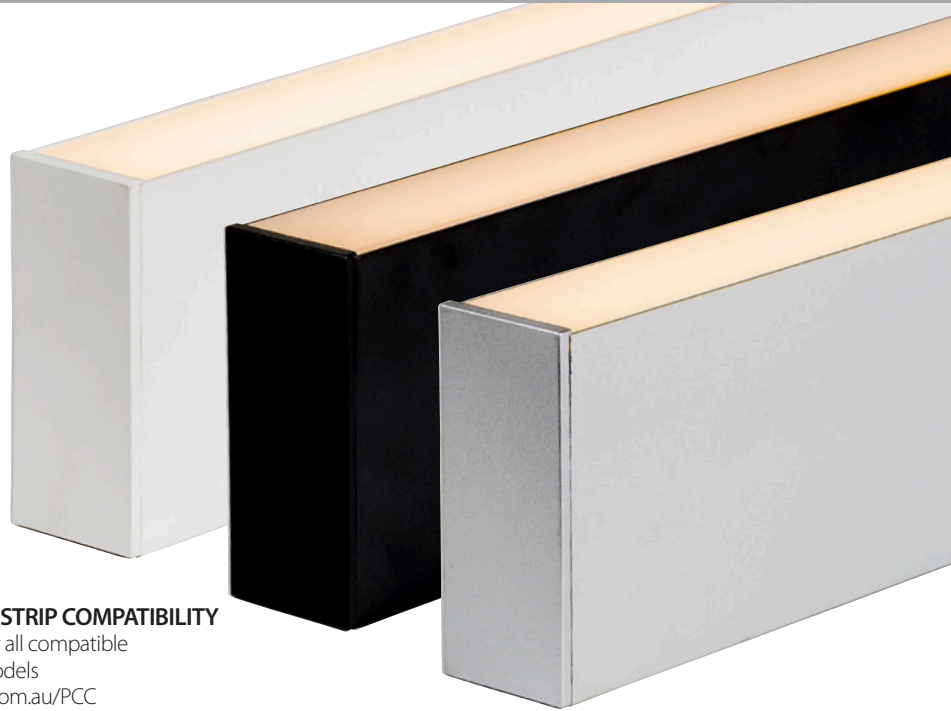
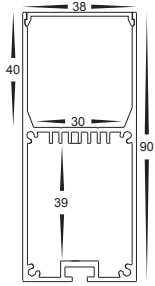







PROFILE & STRIP COMPATIBILITY

Scan to view all compatible LED Strip models
www.havit.com.au/PCC

PART NUMBER	DESCRIPTION	IP RATING	MAX LENGTH
HV9693-3890	38mm x 90mm Square profile with PC diffuser - Kit - / Metre. Custom Cut Length. Supplied with Aluminium, Diffuser + 2x end caps per length	IP20	3 metres
HV9693-3890-3M	3m Length includes aluminium, diffuser + 6x end caps	IP20	3 metres
HV9693-3890-BLK	38mm x 90mm Black Square profile with PC diffuser - Kit - / Metre. Custom Cut Length. Supplied with Black Aluminium, Diffuser + 2x end caps per length	IP20	3 metres
HV9693-3890-BLK-3M	3m Length includes aluminium, diffuser + 6x end caps	IP20	3 metres
HV9693-3890-WHT	38mm x 90mm White Square profile with PC diffuser - Kit - / Metre. Custom Cut Length. Supplied with White Aluminium, Diffuser + 2x end caps per length	IP20	3 metres
HV9693-3890-WHT-3M	3m Length includes aluminium, diffuser + 6x end caps	IP20	3 metres

HAVIT COMPATIBLE ACCESSORIES

	HV9693-3890-SD-ROLL: Diffuser available for continuous run of up to 20 metres
	HV9693-3890-BLKSD: Black diffuser to suit HV9693-3890 up to 3m length
	HV9693-3890-JOINER: Joiner kit to allow multiple lengths to be joined to form a continuous run.
	HV9705-9953: Optional suspension kit
	HV9705-9953-BLK
	HV9705-9953-WHT

SAMPLE INSTALLATION METHOD

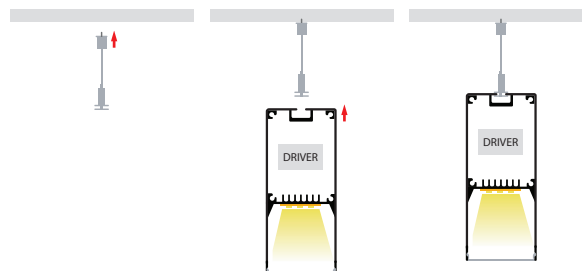

Square LED Profile

- Large shallow square profile
- UV Stabilised PC diffuser

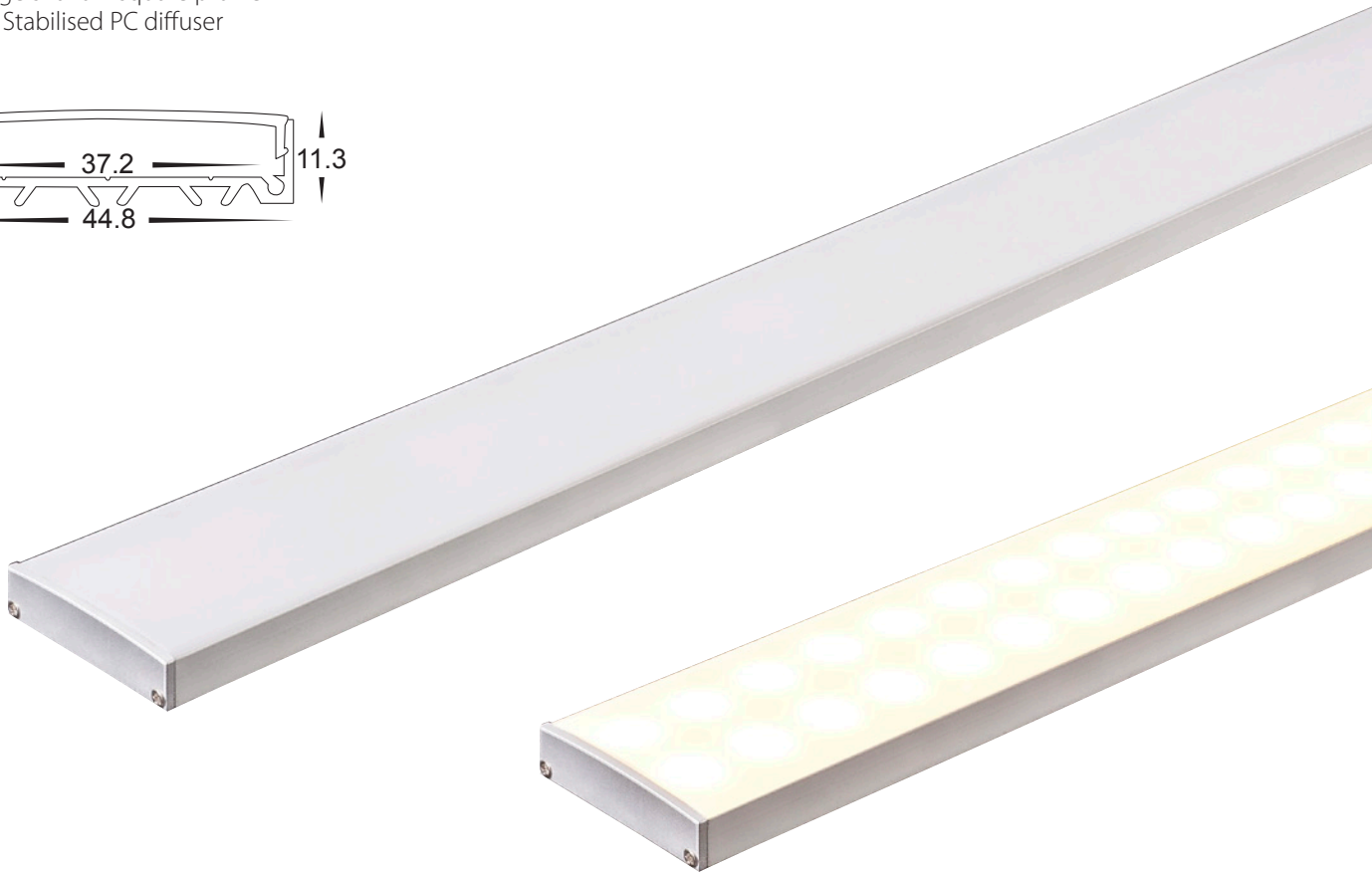
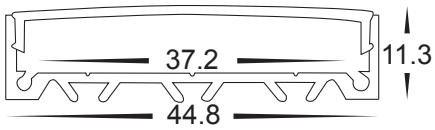

PROFILE & STRIP COMPATIBILITY

Scan to view all compatible LED Strip models
www.havit.com.au/PCC



PART NUMBER	DESCRIPTION	IP RATING	MAX LENGTH
HV9693-4511	45mm x 11mm Large shallow square profile with PC diffuser - Kit - / Metre. Custom Cut Length. Supplied with Aluminium, Diffuser + 2x end caps per length	IP20	3 metres
HV9693-4511-3M	3m Length includes aluminium, diffuser + 6x end caps	IP20	3 metres

HAVIT COMPATIBLE ACCESSORIES



HV9693-4511-SD-ROLL: Diffuser available for continuous run of up to 20 metres

SAMPLE INSTALLATION METHOD



For detailed product specifications visit www.Havit.com.au or scan this QR code

Square LED Profile

- Deep square profile
- UV Stabilised PC diffuser

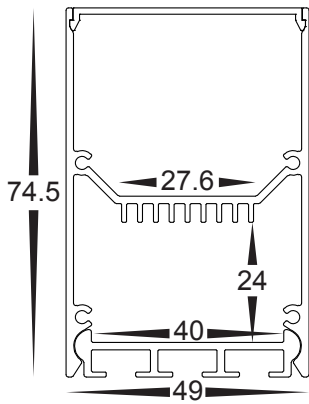

PROFILE & STRIP COMPATIBILITY

Scan to view all compatible LED Strip models
www.havit.com.au/PCC



PART NUMBER	DESCRIPTION	IP RATING	MAX LENGTH
HV9693-4975	49mm x 75mm Deep square profile with PC diffuser - Kit - / Metre. Custom Cut Length. Supplied with Aluminium, Diffuser + 2x end caps per length	IP20	3 metres
HV9693-4975-3M	3m Length includes aluminium, diffuser + 6x end caps	IP20	3 metres

HAVIT COMPATIBLE ACCESSORIES



HV9705-9953: Optional suspension kit

SAMPLE INSTALLATION METHOD

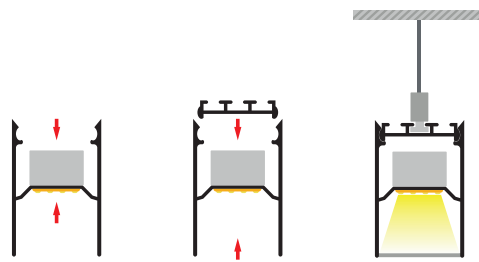

Square LED Profile

- Large Square Profile
- UV Stabilised PC diffuser

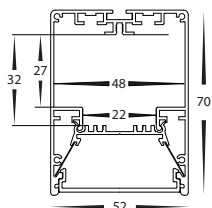

PROFILE & STRIP COMPATIBILITY

Scan to view all compatible LED Strip models
www.havit.com.au/PCC

PART NUMBER	DESCRIPTION	IP RATING	MAX LENGTH
HV9693-5270-BLK	52mm x 70mm Deep Large Square Profile with PC Diffuser - Kit - / Metre. Custom Cut Length Supplied with Black Aluminium, Diffuser + 2x End Caps per length	IP20	3 metres
HV9693-5270-BLK-3M	3m Length includes Black Aluminium, Diffuser + 6x end caps	IP20	3 metres
HV9693-5270-WHT	52mm x 70mm Deep Large Square Profile with PC Diffuser - Kit - / Metre. Custom Cut Length Supplied with White Aluminium, Diffuser + 2x End Caps per length	IP20	3 metres
HV9693-5270-WHT-3M	3m Length includes White Aluminium, Diffuser + 6x end caps	IP20	3 metres

HAVIT COMPATIBLE ACCESSORIES

	HV9693-5270-SD-ROLL	Diffuser available for continuous run of up to 20 metres		HV9693-5270-JOINER-L30°	30° L Joiner
	HV9693-5270-BLKSD	Black Diffuser to suit up to 3m Length		HV9693-5270-JOINER-L60°	60° L Joiner
	HV9693-5270-AGD	Anti Glare Diffuser - Per Metre		HV9693-5270-JOINER-X30°	30° X Joiner
	HV9693-5270-BLKALU	Black Aluminium Diffuser - Per Metre		HV9693-5270-JOINER-Y30°	30° Y Joiner
	HV9693-5270-WHTALU	White Aluminium Diffuser - Per Metre		HV9693-5270-LJOINER	L Shape Joiner
	HV9693-5270-JOINER	Straight Joiner to allow multiple lengths to be joined to form a continuous run		HV9693-5270-LJOINER-2	Vertical L Shape Joiner
	HV9693-5270-JOINER-120°	120° Joiner		HV9705-SM	Optional Surface Mounting Clip
	HV9693-5270-JOINER-150°	150° Joiner		HV9705-9953	Optional suspension kit
	HV9693-5270-JOINER-180°	180° Joiner		HV9705-9953-BLK	
	HV9693-5270-JOINER-L120°	120° L Joiner		HV9705-9953-WHT	

SAMPLE INSTALLATION METHOD

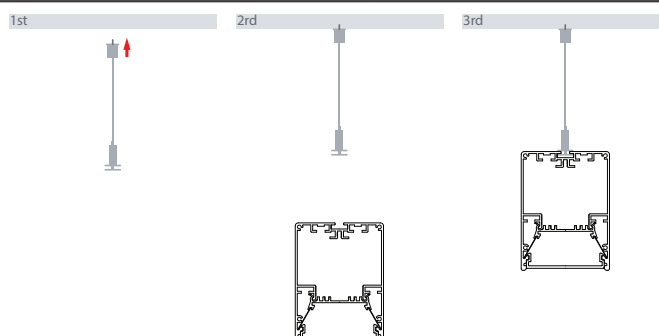

For detailed product specifications visit www.Havit.com.au or scan this QR code

Square LED Profile

- Large Square Profile
- Anti Glare Crate Diffuser

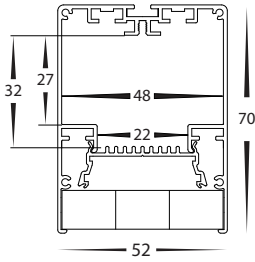

PROFILE & STRIP COMPATIBILITY

Scan to view all compatible LED Strip models
www.havit.com.au/PCC

PART NUMBER	DESCRIPTION	IP RATING	MAX LENGTH
HV9693-5271-BLK	52mm x 70mm Deep Large Square Profile with Crate Diffuser - Kit - / Metre. Custom Cut Length. Supplied with Black Aluminium, Diffuser + 2x End Caps per length	IP20	3 metres
HV9693-5271-BLK-3M	3m Length includes Black Aluminium, Crate Diffuser + 6x end caps	IP20	3 metres
HV9693-5271-WHT	52mm x 70mm Deep Large Square Profile with Crate Diffuser - Kit - / Metre. Custom Cut Length. Supplied with White Aluminium, Crate Diffuser + 2x End Caps per length	IP20	3 metres
HV9693-5271-WHT-3M	3m Length includes White Aluminium, Diffuser + 6x end caps	IP20	3 metres

HAVIT COMPATIBLE ACCESSORIES

	HV9693-5270-JOINER: Straight Joiner to allow multiple lengths to be joined to form a continuous run
	HV9705-SM: Optional Surface Mounting Clip
	HV9705-9953: Optional suspension kit
	HV9705-9953-BLK: Optional suspension kit
	HV9705-9953-WHT: Optional suspension kit

SAMPLE INSTALLATION METHOD

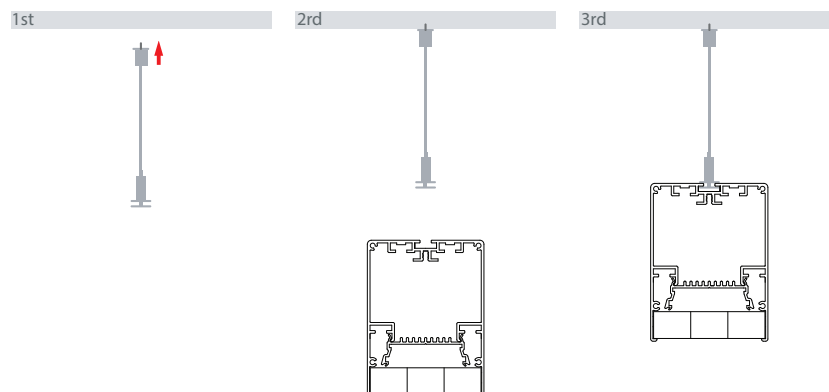

Square LED Profile

- Large square profile
- UV Stabilised PC diffuser

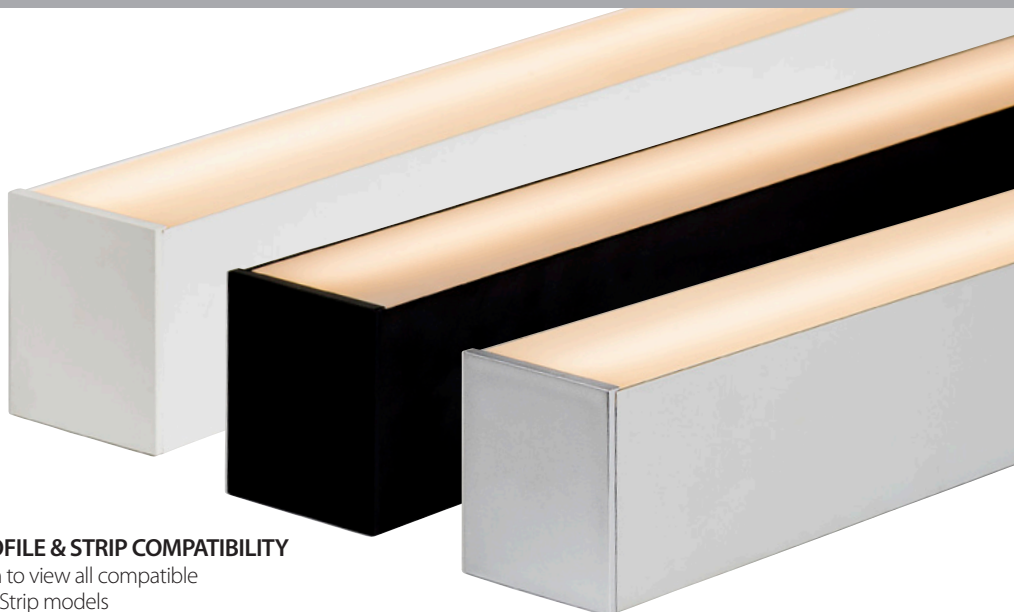
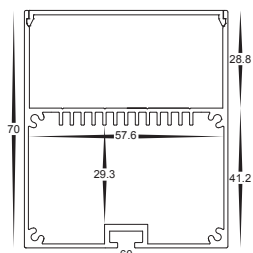







PROFILE & STRIP COMPATIBILITY

Scan to view all compatible LED Strip models
www.havit.com.au/PCC

PART NUMBER	DESCRIPTION	IP RATING	MAX LENGTH
HV9693-6070	60mm x 70mm Deep large square profile with PC diffuser - Kit - / Metre. Custom Cut Length. Supplied with Aluminium, Diffuser + 2x end caps per length	IP20	3 metres
HV9693-6070-3M	3m Length includes aluminium, diffuser + 6x end caps	IP20	3 metres
HV9693-6070-BLK	60mm x 70mm Black deep large square profile with PC diffuser - Kit - / Metre. Custom Cut Length. Supplied with Black Aluminium, Diffuser + 2x end caps per length	IP20	3 metres
HV9693-6070-BLK-3M	3m Length includes aluminium, diffuser + 6x end caps	IP20	3 metres
HV9693-6070-WHT	60mm x 70mm White deep large square profile with PC diffuser - Kit - / Metre. Custom Cut Length. Supplied with White Aluminium, Diffuser + 2x end caps per length	IP20	3 metres
HV9693-6070-WHT-3M	3m Length includes aluminium, diffuser + 6x end caps	IP20	3 metres

HAVIT COMPATIBLE ACCESSORIES

	HV9693-6070-SD-ROLL: Diffuser available for continuous run of up to 20 metres
	HV9693-6070-BLKSD: Black diffuser to suit HV9693-6070 up to 3m length
	HV9693-6070-JOINER: Joiner kit to allow multiple lengths to be joined to form a continuous run.
	HV9705-SM: Optional surface mount clip.
	HV9705-9953: Optional suspension kit
	HV9705-9953-BLK: Optional suspension kit
	HV9705-9953-WHT: Optional suspension kit

SAMPLE INSTALLATION METHOD

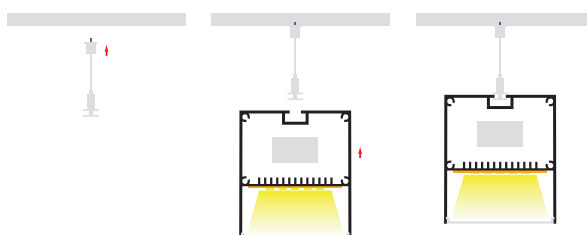

For detailed product specifications visit www.Havit.com.au or scan this QR code

Square LED Profile

- Large Up/Down square profile
- UV Stabilised PC diffuser

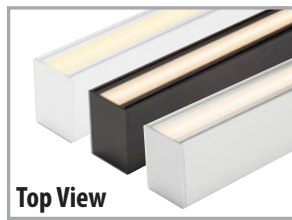
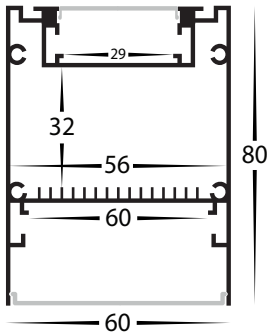





PROFILE & STRIP COMPATIBILITY

Scan to view all compatible LED Strip models www.havit.com.au/PCC

PART NUMBER	DESCRIPTION	IP RATING	MAX LENGTH
HV9693-6080	60mm x 80mm up/down profile with PC diffuser - Kit - / Metre. Custom Cut Length. Supplied with Aluminium, Diffuser + 2x end caps per length	IP20	3 metres
HV9693-6080 -3M	3m Length includes aluminium, diffuser + 6x end caps	IP20	3 metres
HV9693-6080-BLK	60mm x 80mm Black up/down profile with PC diffuser - Kit - / Metre. Custom Cut Length. Supplied with Black Aluminium, Diffuser + 2x end caps per length	IP20	3 metres
HV9693-6080 -BLK-3M	3m Length includes aluminium, diffuser + 6x end caps	IP20	3 metres
HV9693-6080-WHT	60mm x 80mm White up/down profile with PC diffuser - Kit - / Metre. Custom Cut Length. Supplied with White Aluminium, Diffuser + 2x end caps per length	IP20	3 metres
HV9693-6080 -WHT-3M	3m Length includes aluminium, diffuser + 6x end caps	IP20	3 metres

HAVIT COMPATIBLE ACCESSORIES

	HV9693-6080-SD-B-ROLL: Diffuser available for continuous run of up to 20 metres
	HV9693-6080-BLKSD-B: Black diffuser to suit HV9693-6080 up to 3m length
	HV9693-6080-JOINER: Joiner kit to allow multiple lengths to be joined to form a continuous run.
	HV9705-9952: Optional suspension kit

SAMPLE INSTALLATION METHOD

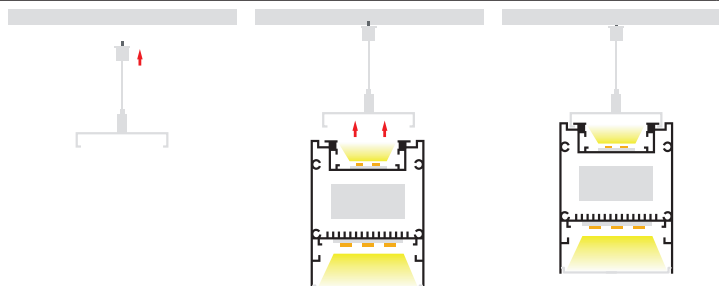

Square LED Profile

- Large deep square profile
- UV Stabilised PC diffuser

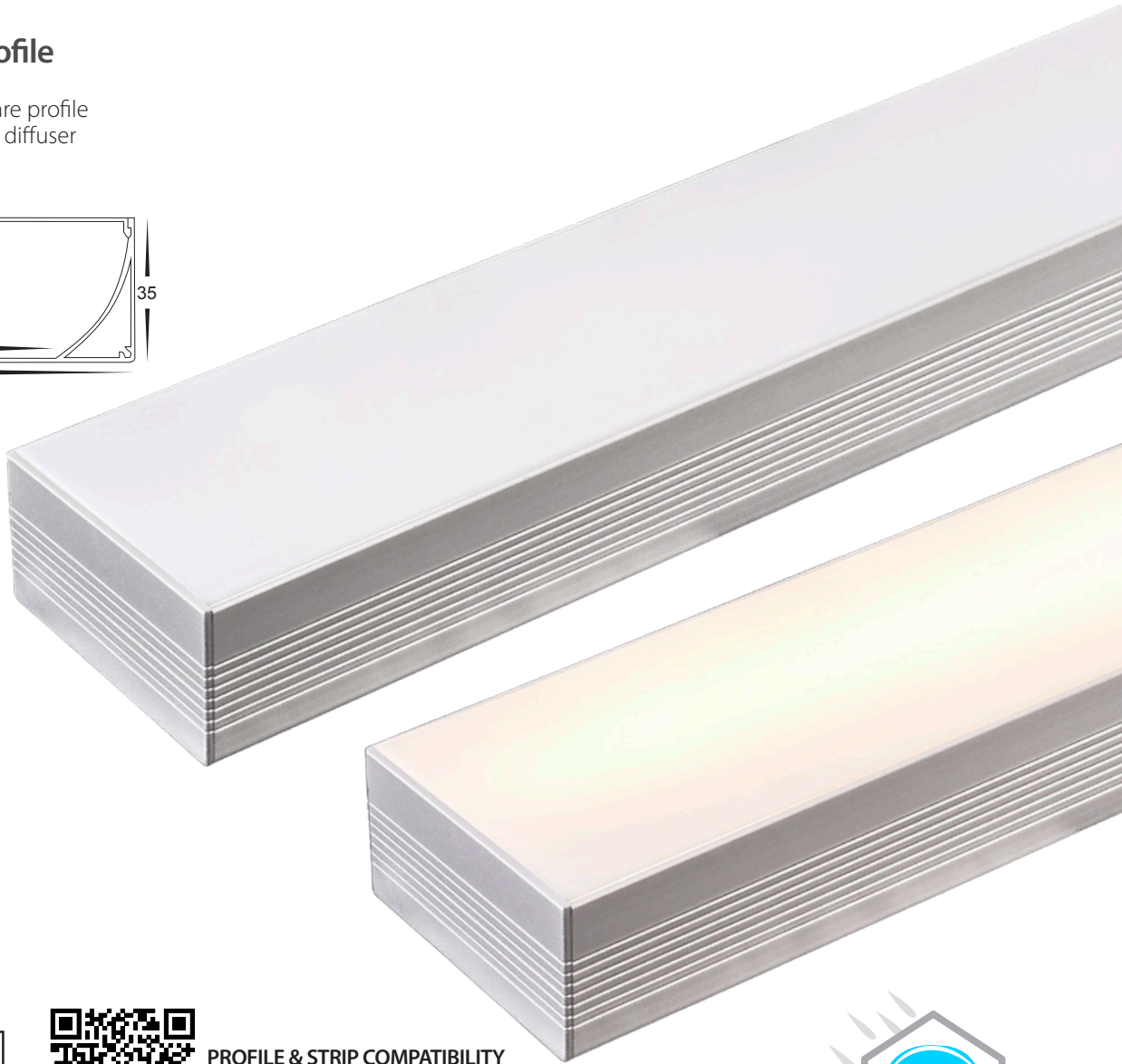
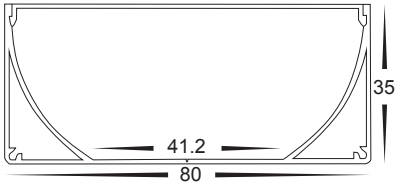

PROFILE & STRIP COMPATIBILITY

Scan to view all compatible LED Strip models
www.havit.com.au/PCC



PART NUMBER	DESCRIPTION	IP RATING	MAX LENGTH
HV9693-8035	80mm x 35mm Large deep square profile with PC diffuser - Kit - / Metre. Custom Cut Length. Supplied with Aluminium, Diffuser + 2x end caps per length	IP20	3 metres
HV9693-8035-3M	3m Length includes aluminium, diffuser + 6x end caps	IP20	3 metres

HAVIT COMPATIBLE ACCESSORIES



HV9693-8035-SD-ROLL: Diffuser available for continuous run of up to 20 metres

SAMPLE INSTALLATION METHOD

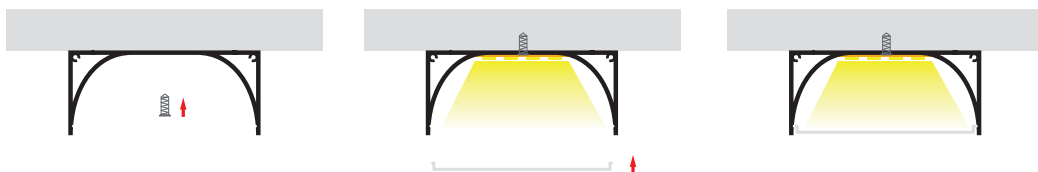

For detailed product specifications visit www.Havit.com.au or scan this QR code

Square LED Profile

- Large deep square profile
- UV Stabilised PC diffuser
- Adjustable strip height via movable insert

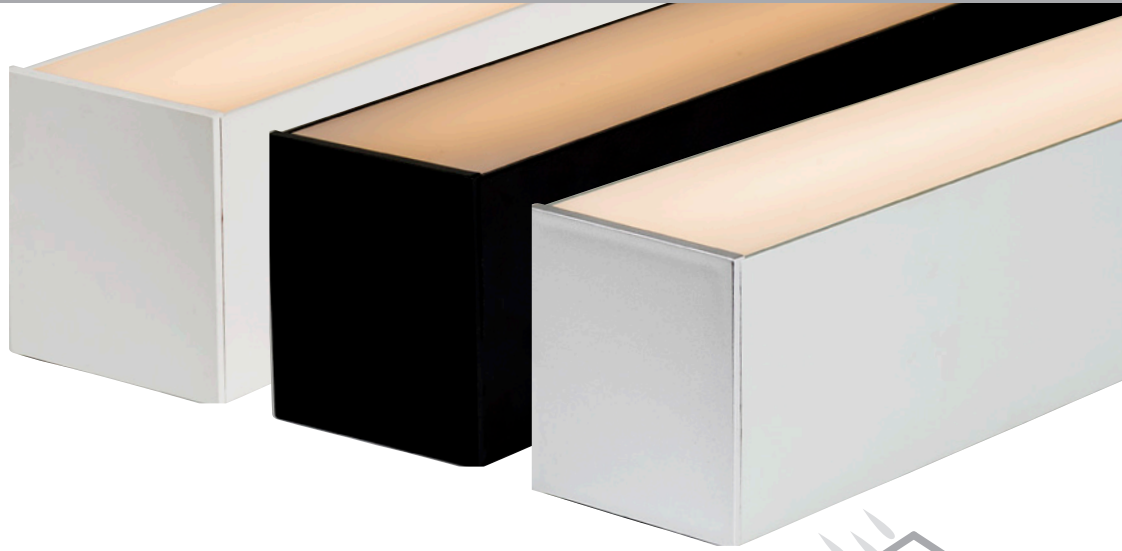
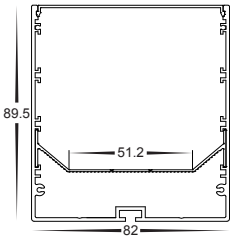







PROFILE & STRIP COMPATIBILITY

Scan to view all compatible LED Strip models
www.havit.com.au/PCC



PART NUMBER	DESCRIPTION	IP RATING	MAX LENGTH
HV9693-8090	82mm x 90mm Deep large square profile with PC diffuser - Kit - / Metre. Custom Cut Length. Supplied with Aluminium, Diffuser + 2x end caps per length	IP20	3 metres
HV9693-8090-3M	3m Length includes aluminium, diffuser + 6x end caps	IP20	3 metres
HV9693-8090-BLK	82mm x 90mm Black deep large square profile with PC diffuser - Kit - / Metre. Custom Cut Length. Supplied with Black Aluminium, Diffuser + 2x end caps per length	IP20	3 metres
HV9693-8090-BLK-3M	3m Length includes aluminium, diffuser + 6x end caps	IP20	3 metres
HV9693-8090-WHT	82mm x 90mm White deep large square profile with PC diffuser - Kit - / Metre. Custom Cut Length. Supplied with White Aluminium, Diffuser + 2x end caps per length	IP20	3 metres
HV9693-8090-WHT-3M	3m Length includes aluminium, diffuser + 6x end caps	IP20	3 metres

HAVIT COMPATIBLE ACCESSORIES

	HV9693-8090-SD-ROLL: Diffuser available for continuous run of up to 20 metres
	HV9693-8090-BLKSD: Black diffuser to suit HV9693-8090 up to 3m length
	HV9693-6070-JOINER: Joiner kit to allow multiple lengths to be joined to form a continuous run.
	HV9705-9953: Optional suspension kit
	HV9705-9953-BLK: Optional suspension kit
	HV9705-9953-WHT: Optional suspension kit

SAMPLE INSTALLATION METHOD

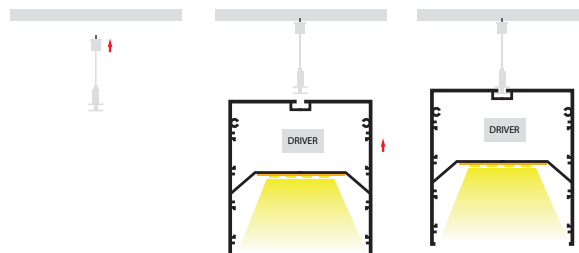

Side Mount LED Profile

- Side Mount LED Profile
- UV Stabilised PC diffuser

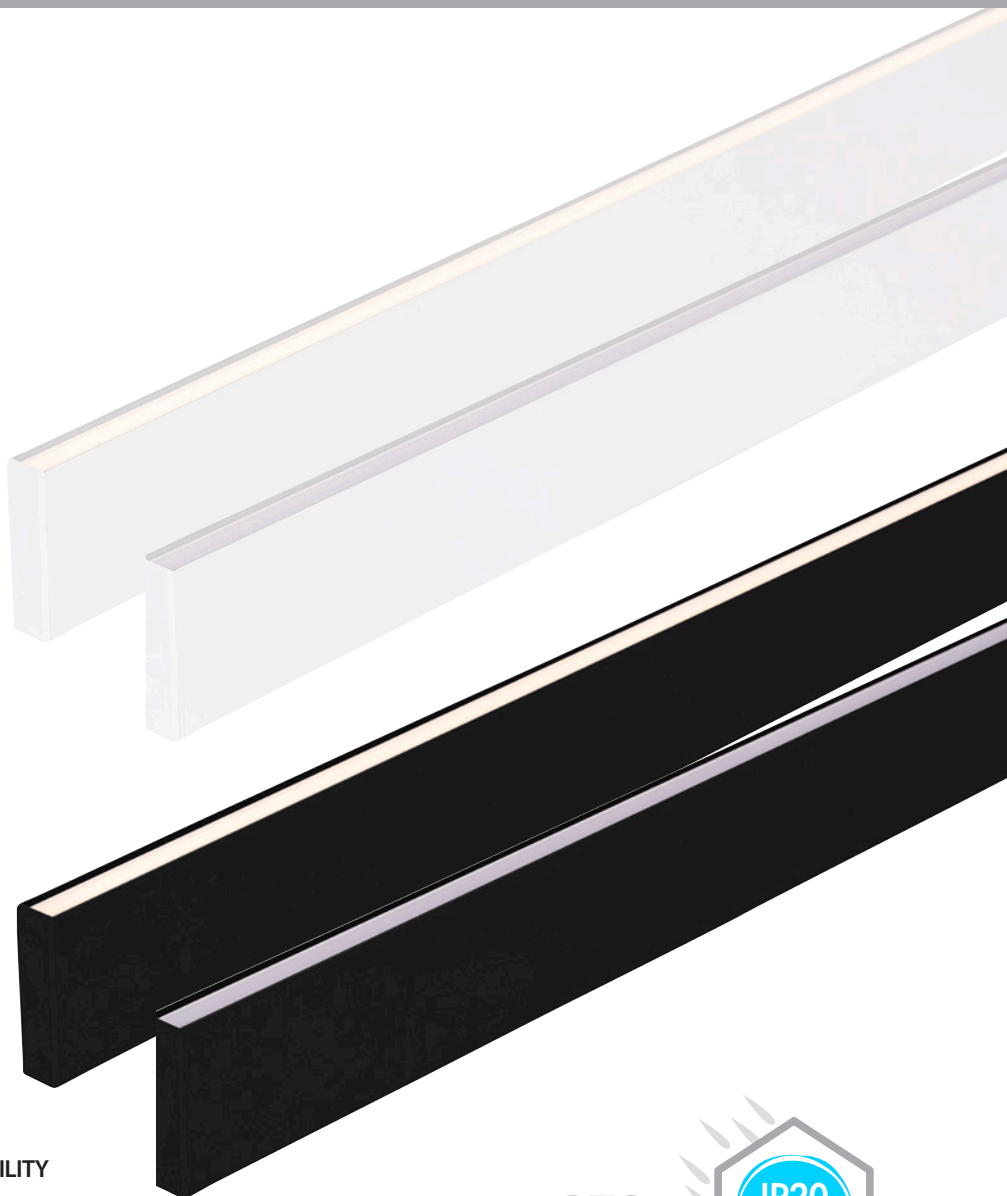
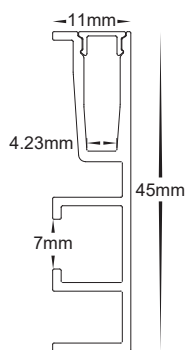

PROFILE & STRIP COMPATIBILITY

Scan to view all compatible LED Strip models
www.havit.com.au/PCC



PART NUMBER	DESCRIPTION	IP RATING	MAX LENGTH
HV9694-1145-BLK	11mm x 45mm Black side mounted profile with PC diffuser - Kit - / Metre. Custom Cut Length. Supplied with Black Aluminium, Diffuser, 2x mounting clips per metre + 2x end caps per length	IP20	3 metres
HV9694-1145-BLK-3M	3m Length includes aluminium, diffuser + 6x end caps & 6x mounting clips	IP20	3 metres
HV9694-1145-WHT	11mm x 45mm White side mounted profile with PC diffuser - Kit - / Metre. Custom Cut Length. Supplied with White Aluminium, Diffuser, 2x mounting clips per metre + 2x end caps per length	IP20	3 metres
HV9694-1145-WHT-3M	3m Length includes aluminium, diffuser + 6x end caps & 6x mounting clips	IP20	3 metres

SAMPLE INSTALLATION METHOD

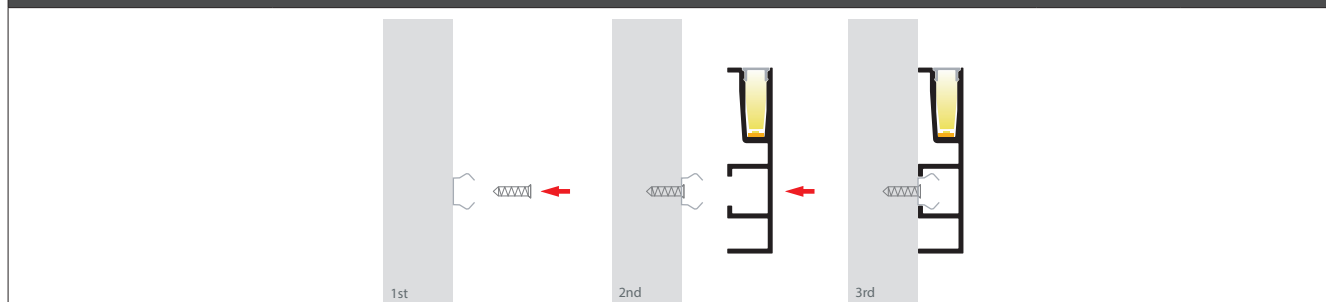

For detailed product specifications visit www.Havit.com.au or scan this QR code

Up & Down Side Mount

LED Profile

- Up & Down Side Mount LED Profile
- UV Stabilised PC diffusers

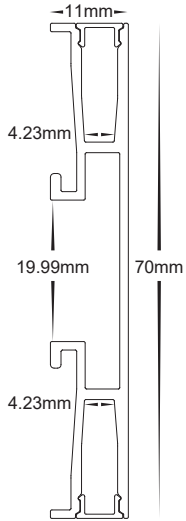

PROFILE & STRIP COMPATIBILITY

Scan to view all compatible LED Strip models
www.havit.com.au/PCC



PART NUMBER	DESCRIPTION	IP RATING	MAX LENGTH
HV9694-1170-BLK	11mm x 70mm Black up/down side mounted profile with PC diffuser - Kit - / Metre. Custom Cut Length. Supplied with Black Aluminium, Diffuser, 2x mounting clips per metre + 2x end caps per length	IP20	3 metres
HV9694-1170-BLK-3M	3m Length includes aluminium, diffuser + 6x end caps & 6x mounting clips	IP20	3 metres
HV9694-1170-WHT	11mm x 70mm White up/down side mounted profile with PC diffuser - Kit - / Metre. Custom Cut Length. Supplied with White Aluminium, Diffuser, 2x mounting clips per metre + 2x end caps per length	IP20	3 metres
HV9694-1170-WHT-3M	3m Length includes aluminium, diffuser + 6x end caps & 6x mounting clips	IP20	3 metres

SAMPLE INSTALLATION METHOD

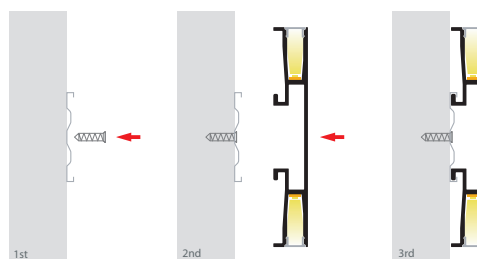

Side Mount LED Profile

- Slim side mounted square profile
- UV Stabilised PC diffuser

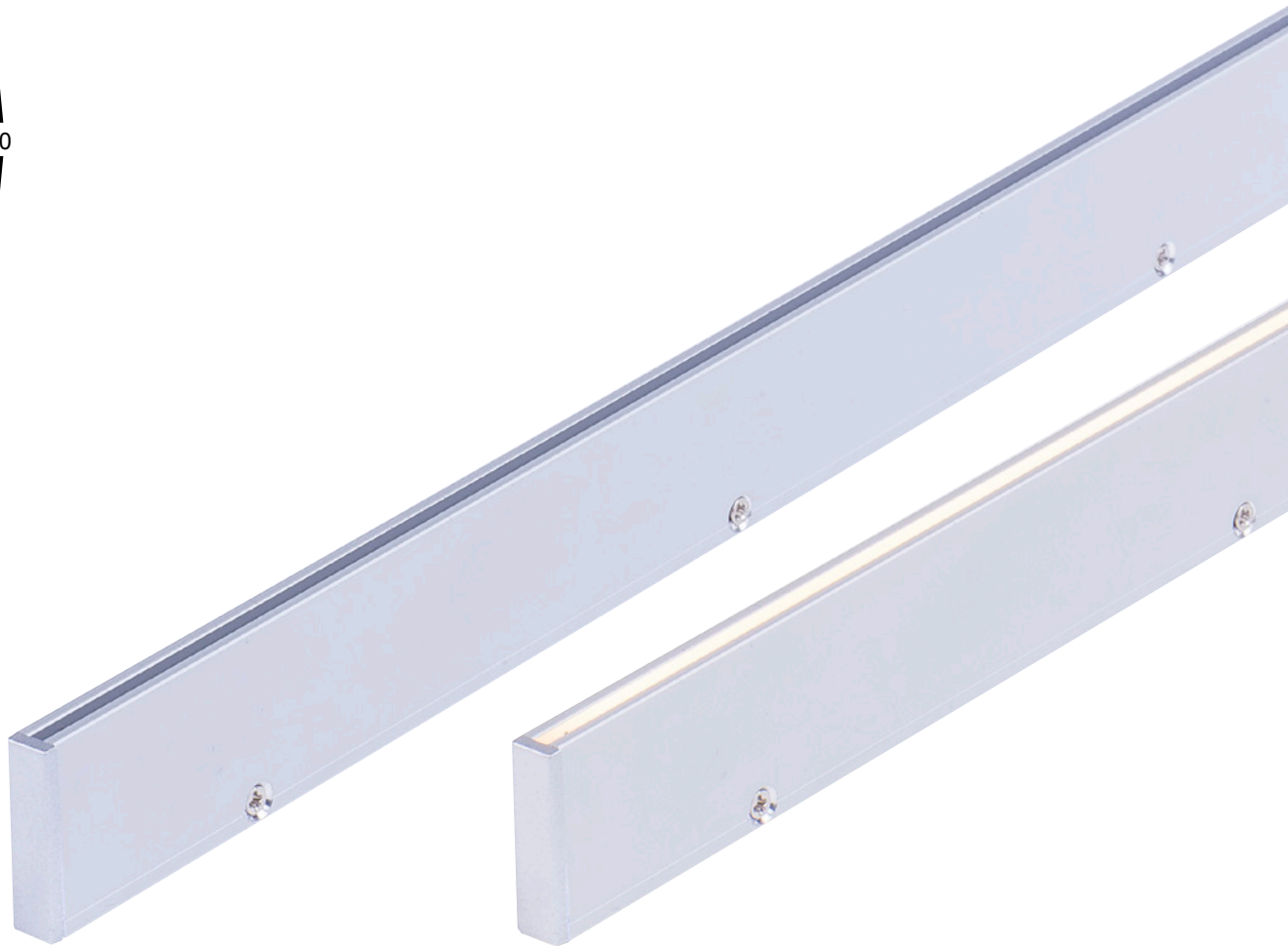
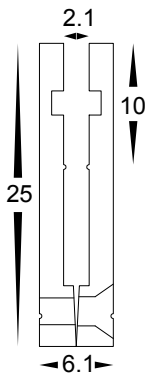

PROFILE & STRIP COMPATIBILITY

Scan to view all compatible LED Strip models
www.havit.com.au/PCC



PART NUMBER	DESCRIPTION	IP RATING	MAX LENGTH
HV9694-0625	6mm x 25mm Side Mounted square profile with UV Stabilised PC diffuser - Kit - / Metre. Custom Cut Length. Supplied with Aluminium, Diffuser + 2x end caps per length	IP20	1 metres

SAMPLE INSTALLATION METHOD

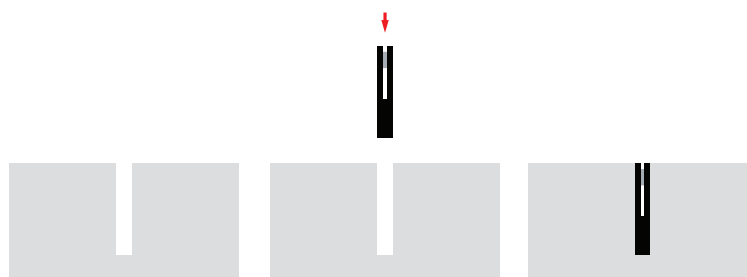

For detailed product specifications visit www.Havit.com.au or scan this QR code

Micro Winged LED Profile

- Shallow micro winged square profile
- UV Stabilised PC diffuser
- Suitable for recessed installation

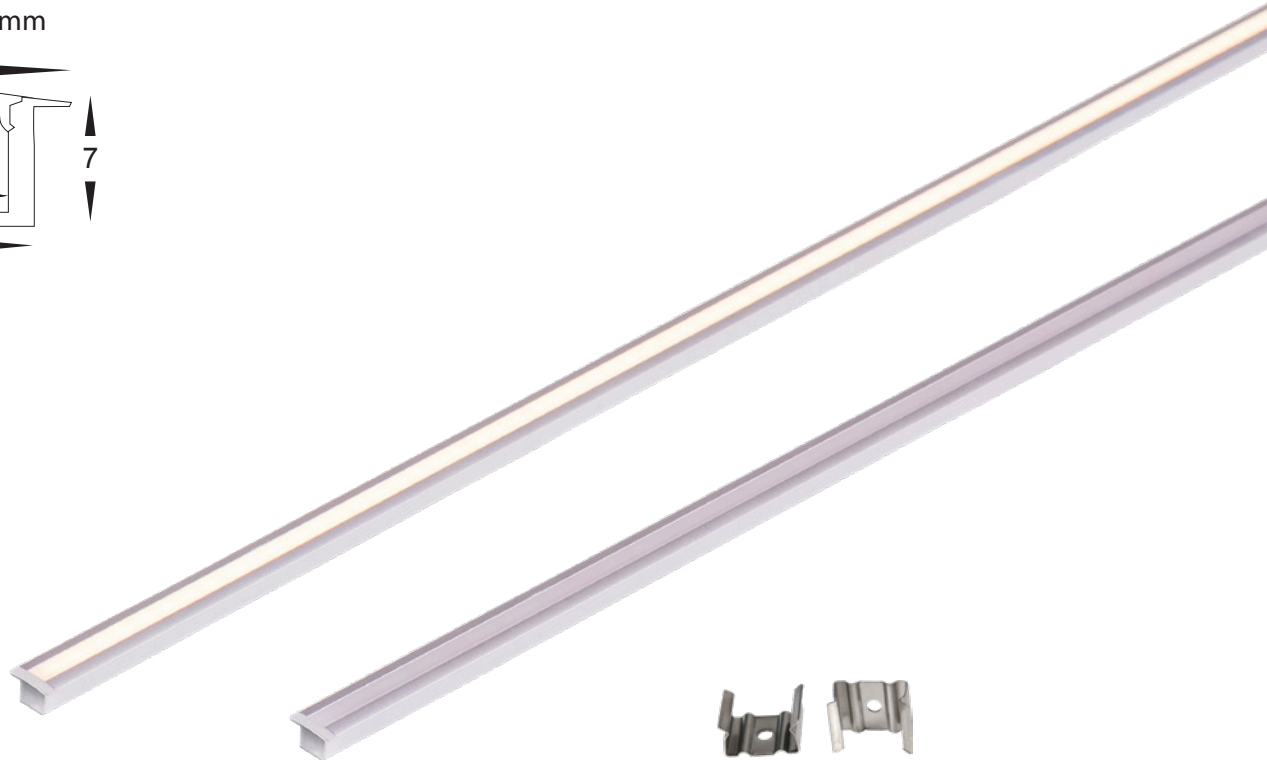
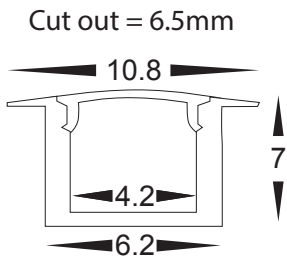

PROFILE & STRIP COMPATIBILITY
 Scan to view all compatible LED Strip models
www.havit.com.au/PCC



PART NUMBER	DESCRIPTION	IP RATING	MAX LENGTH
HV9695-1107	11mm x 7mm Micro winged square profile with UV Stabilised PC diffuser - Kit - / Metre. Custom Cut Length. Supplied with Aluminium, Diffuser, 2x mounting clips per metre + 2x end caps per length	IP20	3 metres
HV9695-1107-3M	3m Length includes aluminium, diffuser + 6x end caps	IP20	3 metres

SAMPLE INSTALLATION METHOD

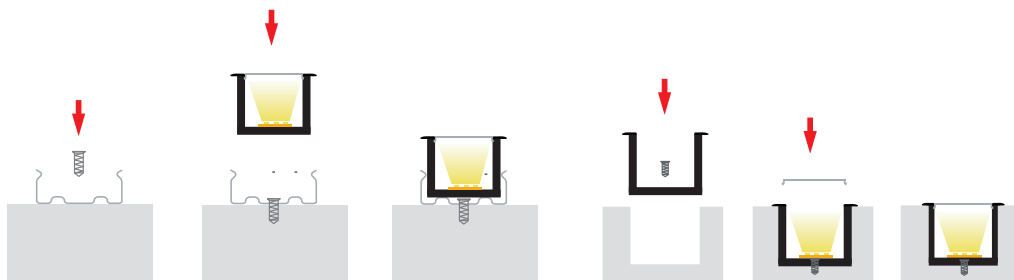

Winged LED Profile

- Shallow winged square profile
- UV Stabilised PC diffuser
- Suitable for recessed installation

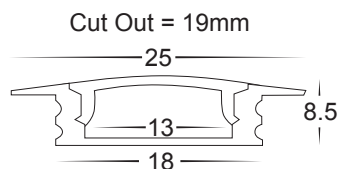



PROFILE & STRIP COMPATIBILITY

Scan to view all compatible
LED Strip models
www.havit.com.au/PCC



PART NUMBER	DESCRIPTION	IP RATING	MAX LENGTH
HV9695-2507	25mm x 9mm Shallow winged square profile with PC diffuser - Kit - / Metre. Custom Cut Length. Supplied with Aluminium, Diffuser, 2x mounting clips per metre + 2x end caps per length	IP20	3 metres
HV9695-2507-3M	3m Length includes aluminium, diffuser + 6x end caps & 6x mounting clips	IP20	3 metres
HV9695-2507-BLK	25mm x 9mm Black shallow winged square profile with PC diffuser - Kit - / Metre. Custom Cut Length. Supplied with Black Aluminium, Diffuser, 2x mounting clips per metre + 2x end caps per length	IP20	3 metres
HV9695-2507-BLK-3M	3m Length includes aluminium, diffuser + 6x end caps & 6x mounting clips	IP20	3 metres
HV9695-2507-WHT	25mm x 9mm White shallow winged square profile with PC diffuser - Kit - / Metre. Custom Cut Length. Supplied with White Aluminium, Diffuser, 2x mounting clips per metre + 2x end caps per length	IP20	3 metres
HV9695-2507-WHT-3M	3m Length includes aluminium, diffuser + 6x end caps & 6x mounting clips	IP20	3 metres

HAVIT COMPATIBLE ACCESSORIES

	HV9695-2507-SD-ROLL: Diffuser available for continuous run of up to 20 metres
	HV9695-2507-BLKSD: Black diffuser to suit HV9695-2507 up to 3m length

SAMPLE INSTALLATION METHOD

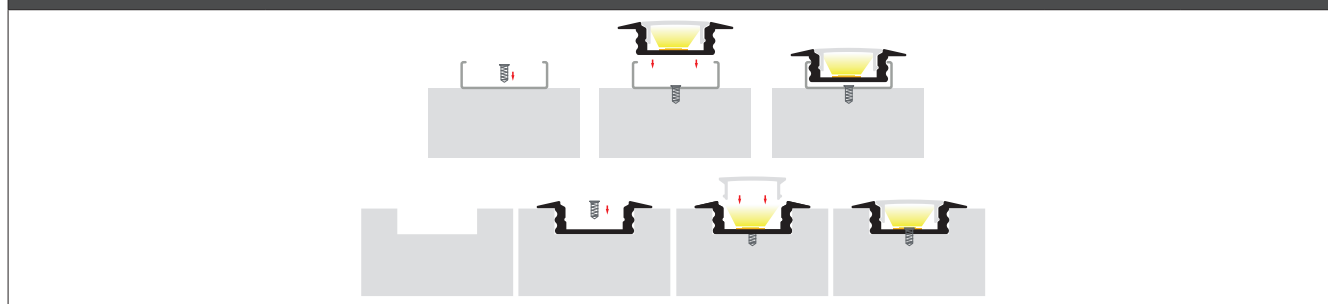

For detailed product specifications
visit www.Havit.com.au
or scan this QR code

Winged LED Profile

- Deep winged square profile
- UV Stabilised PC diffuser
- Suitable for recessed installation

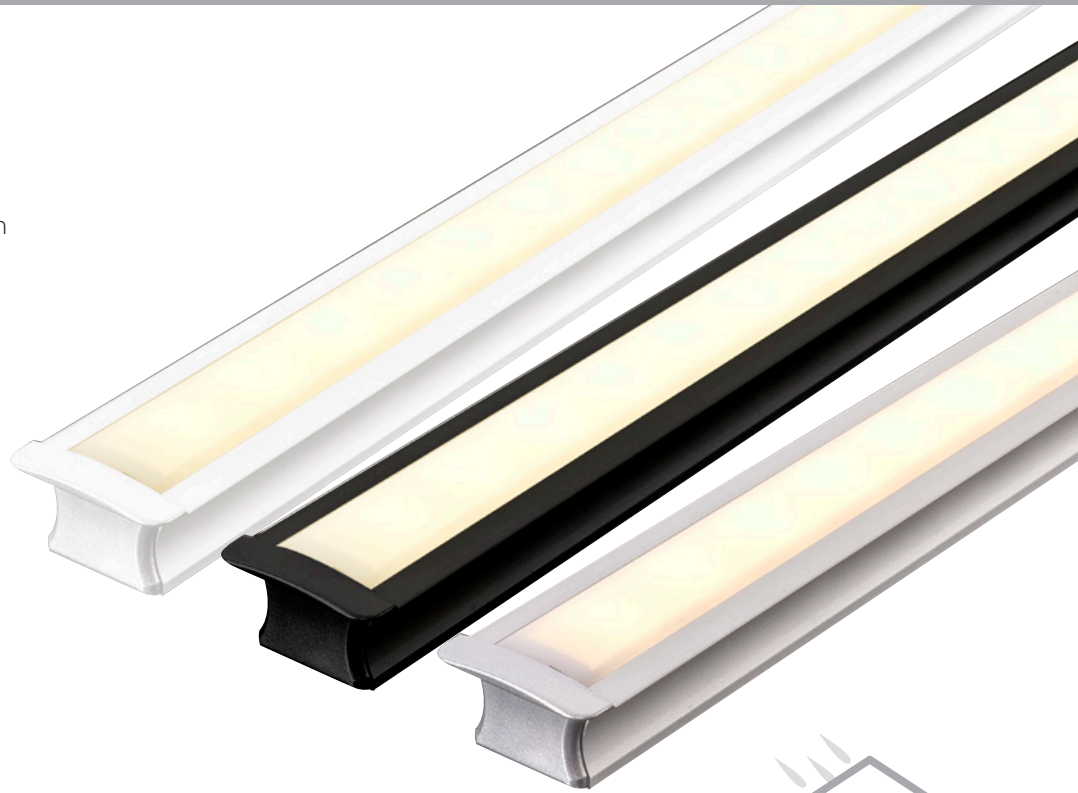
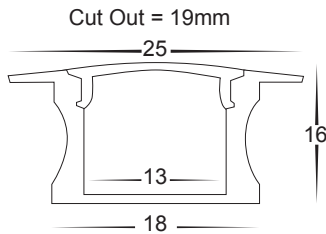

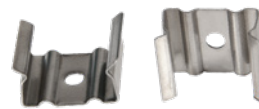

PROFILE & STRIP COMPATIBILITY

Scan to view all compatible
LED Strip models
www.havit.com.au/PCC



PART NUMBER	DESCRIPTION	IP RATING	MAX LENGTH
HV9695-2515	25mm x 16mm Deep winged square profile with PC diffuser - Kit - / Metre. Custom Cut Length. Supplied with Aluminium, Diffuser, 2x mounting clips per metre + 2x end caps per length	IP20	3 metres
HV9695-2515-3M	3m Length includes aluminium, diffuser + 6x end caps & 6x mounting clips	IP20	3 metres
HV9695-2515-BLK	25mm x 16mm Black Deep winged square profile with PC diffuser - Kit - / Metre. Custom Cut Length. Supplied with Black Aluminium, Diffuser, 2x mounting clips per metre + 2x end caps per length	IP20	3 metres
HV9695-2515-BLK-3M	3m Length includes aluminium, diffuser + 6x end caps & 6x mounting clips	IP20	3 metres
HV9695-2515-WHT	25mm x 16mm White Deep winged square profile with PC diffuser - Kit - / Metre. Custom Cut Length. Supplied with White Aluminium, Diffuser, 2x mounting clips per metre + 2x end caps per length	IP20	3 metres
HV9695-2515-WHT-3M	3m Length includes aluminium, diffuser + 6x end caps & 6x mounting clips	IP20	3 metres

HAVIT COMPATIBLE ACCESSORIES

	HV9695-2515-SD-ROLL: Diffuser available for continuous run of up to 20 metres
	HV9695-2515-BLKSD: Black diffuser to suit HV9695-2515 up to 3m length

SAMPLE INSTALLATION METHOD

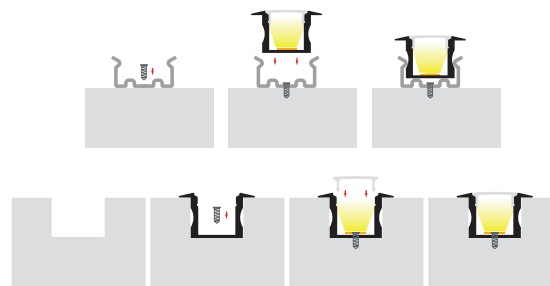

Winged LED Profile

- Deep winged square profile
- UV Stabilised PC diffuser
- Supplied with spring clips
- Suitable for recessed installation

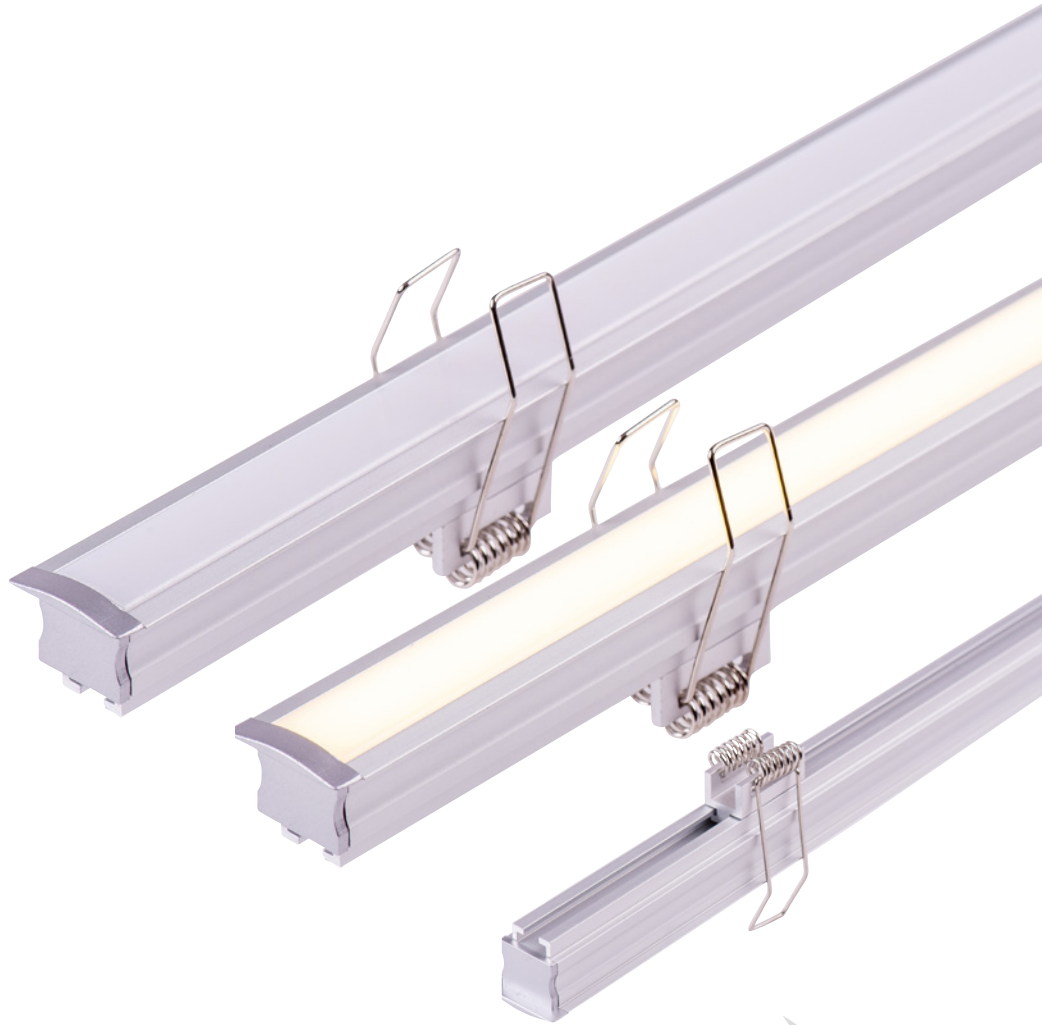
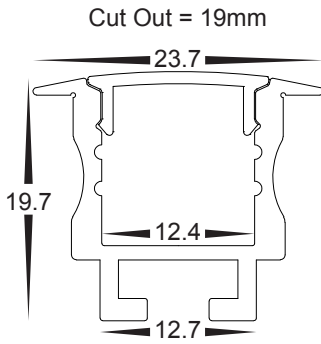

PROFILE & STRIP COMPATIBILITY

Scan to view all compatible LED Strip models
www.havit.com.au/PCC



PART NUMBER	DESCRIPTION	IP RATING	MAX LENGTH
HV9695-2520	25mm x 20mm Deep winged square profile with UV Stabilised PC diffuser - Kit - / Metre. Custom Cut Length. Supplied with Aluminium, Diffuser, 2x Spring Clips per metre + 2x end caps per length	IP20	3 metres
HV9695-2520 -3M	3m Length includes aluminium, diffuser + 6x end caps & 6x spring clips	IP20	3 metres

HAVIT COMPATIBLE ACCESSORIES



HV9695-2520-SD-ROLL: Diffuser available for continuous run of up to 20 metres

SAMPLE INSTALLATION METHOD

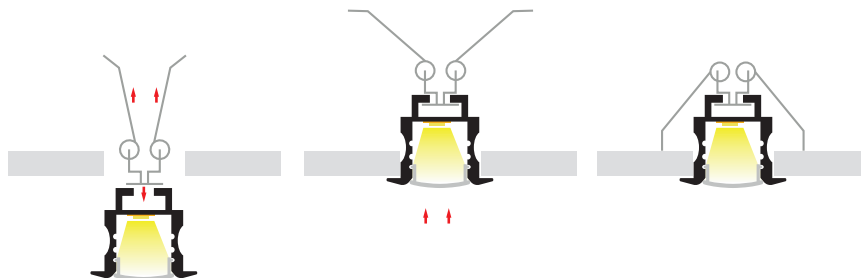

For detailed product specifications visit www.Havit.com.au or scan this QR code

Winged LED Profile

- Deep winged square profile
- UV Stabilised PC diffuser
- Suitable for recessed installation
- Supplied with spring clips

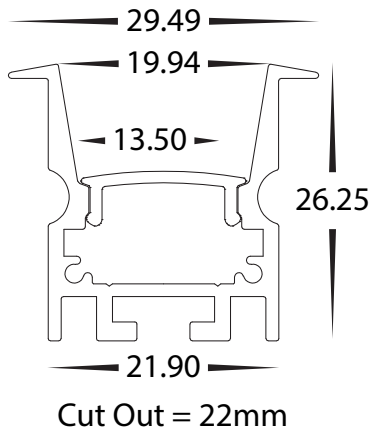

PROFILE & STRIP COMPATIBILITY

Scan to view all compatible LED Strip models
www.havit.com.au/PCC

PART NUMBER	DESCRIPTION	IP RATING	MAX LENGTH
HV9695-2926	29mm x26mm Deep winged square profile with UV Stabilised PC Diffuser-Kit-/ Metre Custom cut length supplied with Aluminium, Diffuser, 2X Spring Clips per metre + 2x end caps per length	IP20	3 metres
HV9695-2926-3M	3m Length includes aluminium, diffuser + 6x end caps & 6x spring clips	IP20	3 metres
HV9695-2926-BLK	29mm x26mm Black Deep winged square profile with UV Stabilised PC Diffuser-Kit-/ Metre. Custom cut length supplied with Aluminium, Diffuser, 2X Spring Clips per metre + 2x end caps per length	IP20	3 metres
HV9695-2926-BLK-3M	3m Length includes Black aluminium, diffuser + 6x end caps & 6x spring clips	IP20	3 metres
HV9695-2926-WHT	29mm x26mm White Deep winged square profile with UV Stabilised PC Diffuser-Kit-/ Metre. Custom cut length supplied with Aluminium, Diffuser, 2X Spring Clips per metre + 2x end caps per length	IP20	3 metres
HV9695-2926-WHT-3M	3m Length includes White aluminium, diffuser + 6x end caps & 6x spring clips	IP20	3 metres

HAVIT COMPATIBLE ACCESSORIES



HV9695-2926-SD-ROLL: Diffuser available for continuous run of up to 20 metres

SAMPLE INSTALLATION METHOD

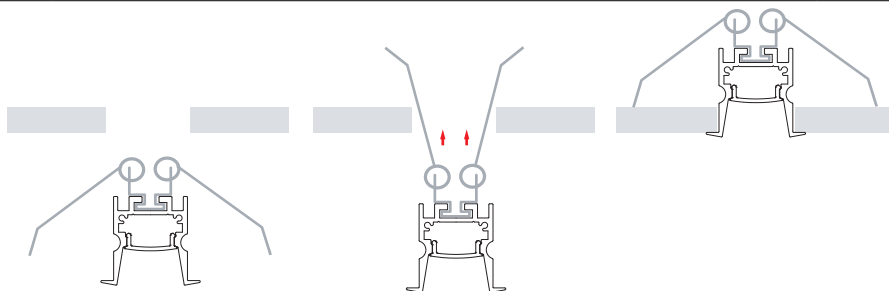

Winged LED Profile

- Shallow winged square profile
- UV Stabilised PC diffuser
- Suitable for recessed installation

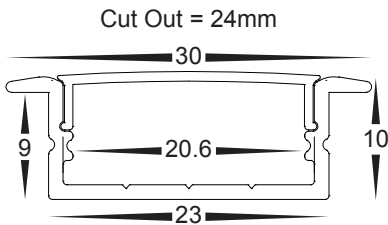

PROFILE & STRIP COMPATIBILITY

Scan to view all compatible LED Strip models
www.havit.com.au/PCC



PART NUMBER	DESCRIPTION	IP RATING	MAX LENGTH
HV9695-2810	30mm x 10mm Shallow winged square profile with UV Stabilised PC diffuser - Kit - / Metre. Custom Cut Length. Supplied with Aluminium, Diffuser, 2x mounting clips per metre + 2x end caps per length	IP20	3 metres
HV9695-2810-3M	3m Length includes aluminium, diffuser + 6x end caps & 6x mounting clips	IP20	3 metres

HAVIT COMPATIBLE ACCESSORIES



HV9695-2810-SD-ROLL: Diffuser available for continuous run of up to 20 metres

SAMPLE INSTALLATION METHOD

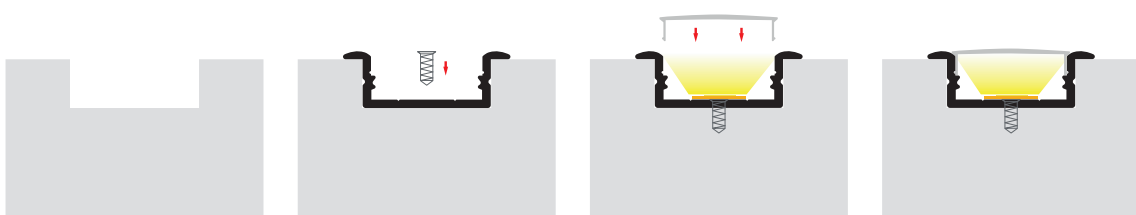

For detailed product specifications visit www.Havit.com.au or scan this QR code

Winged LED Profile

- Large square winged profile
- UV Stabilised PC diffuser
- Suitable for recessed installation

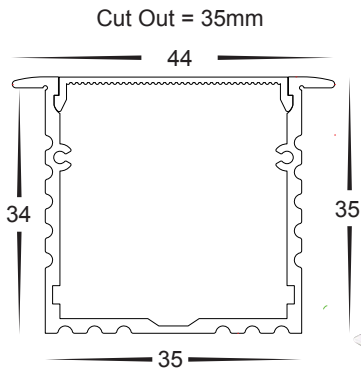

PROFILE & STRIP COMPATIBILITY

Scan to view all compatible LED Strip models
www.havit.com.au/PCC



PART NUMBER	DESCRIPTION	IP RATING	MAX LENGTH
HV9695-4435	44mm x 35mm Large square winged profile with UV Stabilised PC diffuser - Kit - / Metre. Custom Cut Length. Supplied with Aluminium, Diffuser + 2x end caps per length	IP20	3 metres
HV9695-4435-3M	3m Length includes aluminium, diffuser + 6x end caps	IP20	3 metres

HAVIT COMPATIBLE ACCESSORIES



HV9695-4435-SD-ROLL: Diffuser available for continuous run of up to 20 metres

SAMPLE INSTALLATION METHOD

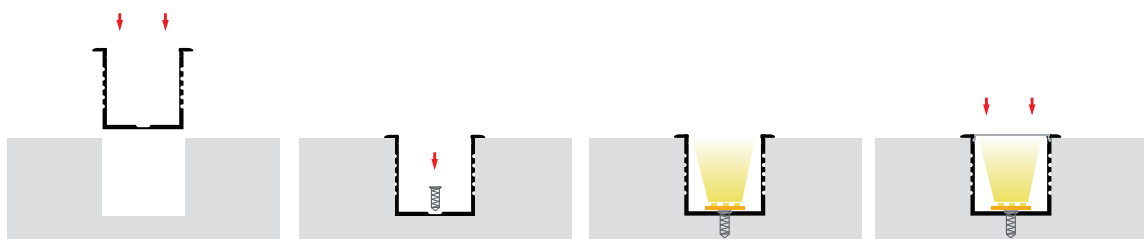

Winged LED Profile

- Large square winged profile
- UV Stabilised PC diffuser
- Supplied with spring clips
- Suitable for recessed installation

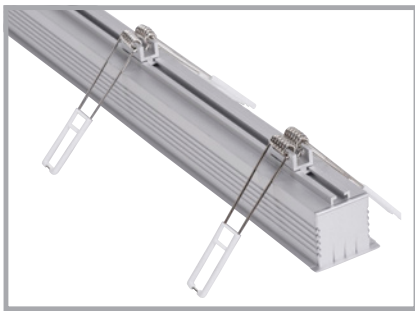
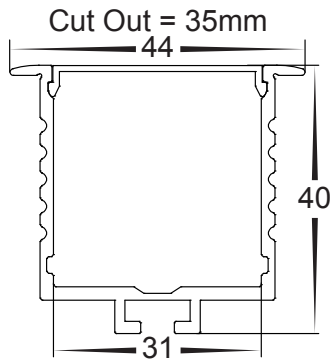

PROFILE & STRIP COMPATIBILITY

Scan to view all compatible LED Strip models
www.havit.com.au/PCC



PART NUMBER	DESCRIPTION	IP RATING	MAX LENGTH
HV9695-4540	44mm x 40mm Large square winged profile with UV Stabilised PC diffuser - Kit - / Metre. Custom Cut Length. Supplied with Aluminium, Diffuser, 2x spring clips per metre + 2x end caps per length	IP20	3 metres
HV9695-4540-3M	3m Length includes aluminium, diffuser + 6x end caps & 6x spring clips	IP20	3 metres

HAVIT COMPATIBLE ACCESSORIES



HV9695-4540-SD-ROLL: Diffuser available for continuous run of up to 20 metres

SAMPLE INSTALLATION METHOD

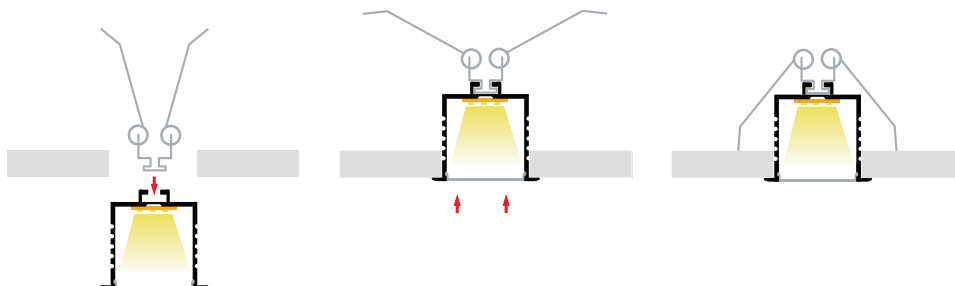

For detailed product specifications visit www.Havit.com.au or scan this QR code

Winged LED Profile

- Large deep square winged profile
- UV Stabilised PC diffuser
- Suitable for recessed installation
- Supplied with spring clips

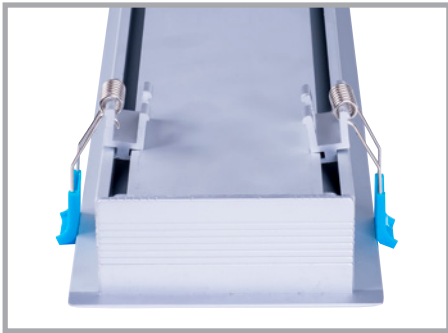
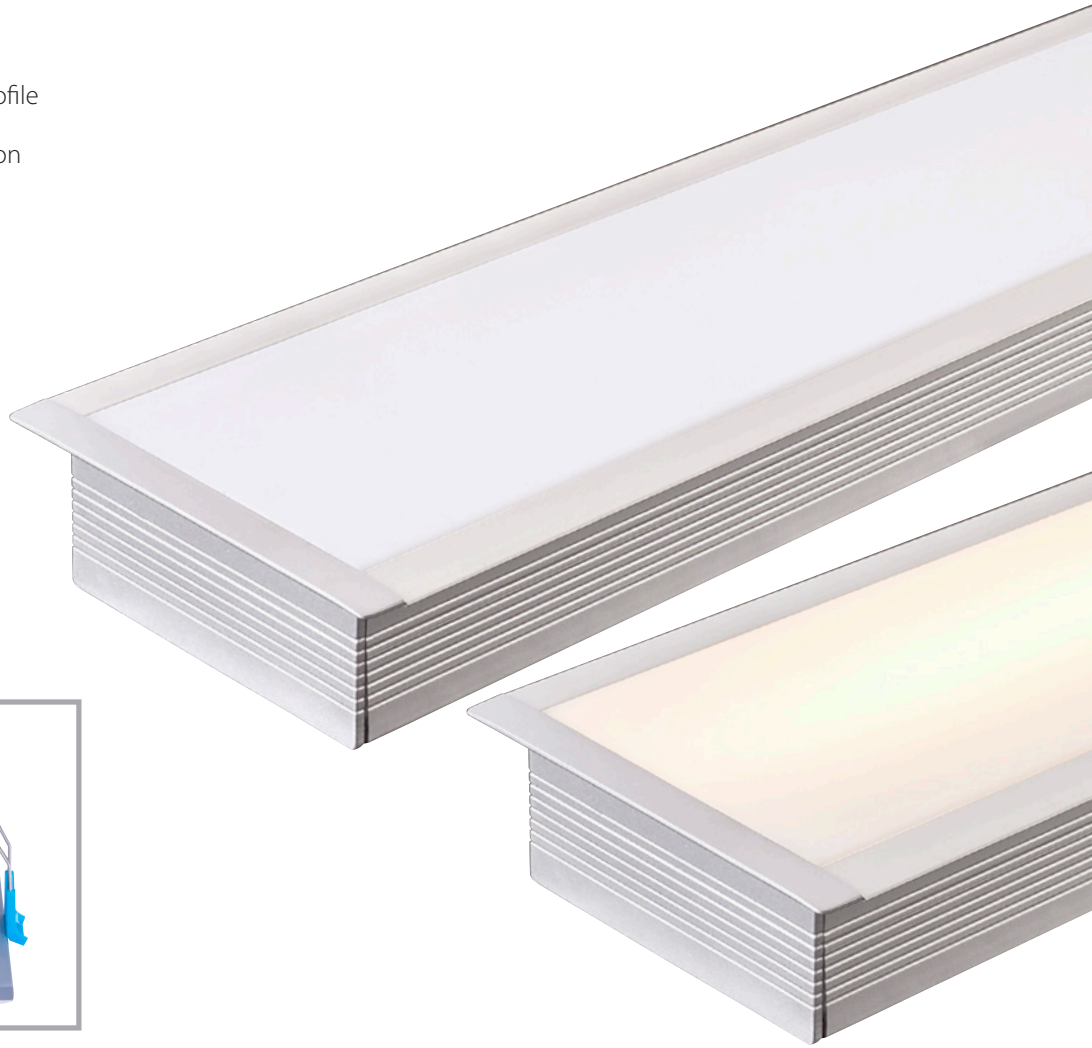
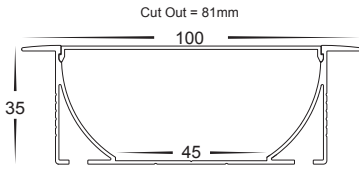

PROFILE & STRIP COMPATIBILITY

Scan to view all compatible LED Strip models
www.havit.com.au/PCC



PART NUMBER	DESCRIPTION	IP RATING	MAX LENGTH
HV9695-9835	100mm x 35mm Large deep square winged profile with PC diffuser - Kit - / Metre. Custom Cut Length. Supplied with Aluminium, Diffuser, 4x spring clips per metre + 2x end caps per length	IP20	3 metres
HV9695-9835-3M	3m Length includes aluminium, diffuser, 12x spring clips + 6x end caps	IP20	3 metres

HAVIT COMPATIBLE ACCESSORIES



HV9695-9835-SD-ROLL: Diffuser available for continuous run of up to 20 metres

SAMPLE INSTALLATION METHOD

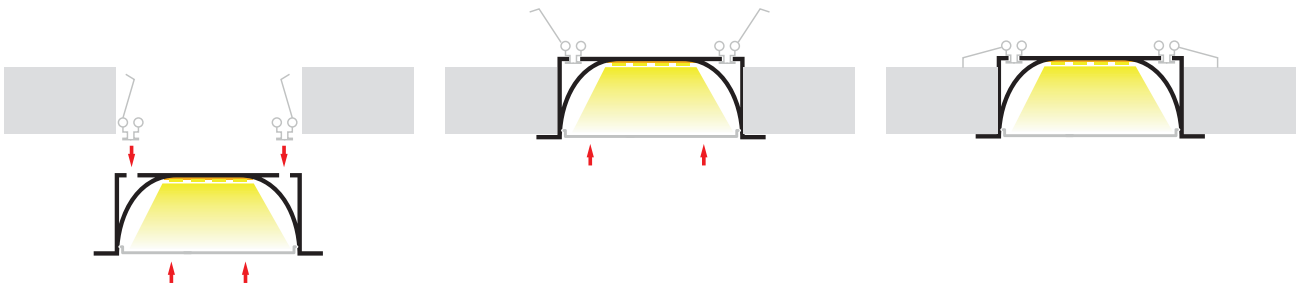

Foot Trafficable LED Profile

- UV Stabilised PC diffuser
- Foot trafficable
- Adequate drainage must be allowed

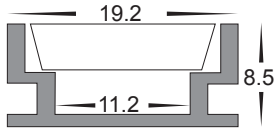

PROFILE & STRIP COMPATIBILITY

Scan to view all compatible LED Strip models
www.havit.com.au/PCC



PART NUMBER	DESCRIPTION	IP RATING	MAX LENGTH
HV9698-1908	19mm x 9mm Profile with PC diffuser - Kit - / Metre. Custom Cut Length. Supplied with Aluminium, Diffuser + 2x end caps per length	IP20	3 metres
HV9698-1908-3M	3m Length includes aluminium, diffuser + 6x end caps	IP20	3 metres

SAMPLE INSTALLATION METHOD

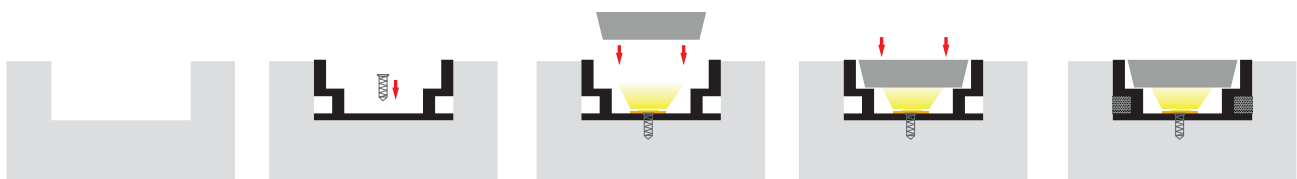

For detailed product specifications visit www.Havit.com.au or scan this QR code

Foot Trafficable LED Profile

- UV Stabilised PC diffuser
- Foot trafficable
- Adequate drainage must be allowed

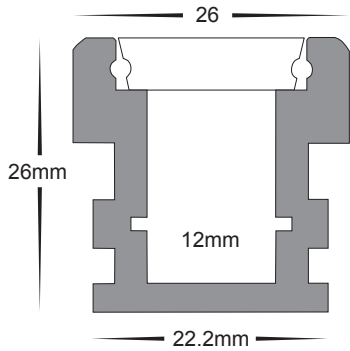

PROFILE & STRIP COMPATIBILITY

Scan to view all compatible LED Strip models
www.havit.com.au/PCC



PART NUMBER	DESCRIPTION	IP RATING	MAX LENGTH
HV9698-2626	26mm x 26mm Profile with PC diffuser - Kit - / Metre. Custom Cut Length. Supplied with Aluminium, Diffuser + 2x end caps per length	IP20	3 metres
HV9698-2626-3M	3m Length includes aluminium, diffuser + 6x end caps	IP20	3 metres

SAMPLE INSTALLATION METHOD

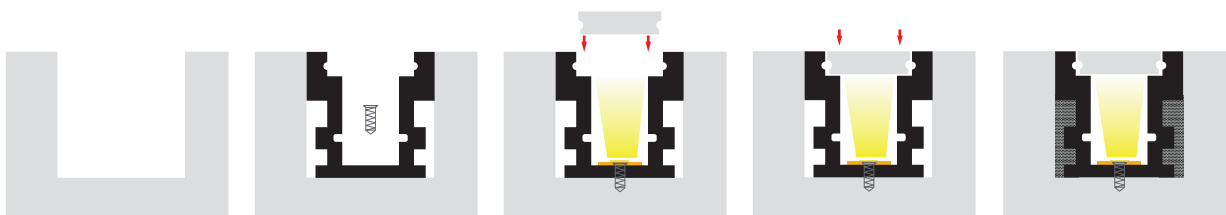

Step Tread LED Profile

- UV Stabilised PC diffuser
- Foot trafficable
- Adequate drainage must be allowed

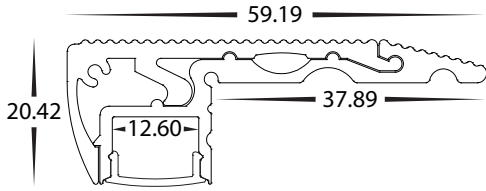

PROFILE & STRIP COMPATIBILITY

Scan to view all compatible
LED Strip models
www.havit.com.au/PCC



PART NUMBER	DESCRIPTION	IP RATING	MAX LENGTH
HV9698-6020	60mm x 20mm Step Tread profile with UV Stabilised PC Diffuser-Kit-/ Metre Ccustom cut length supplied with Aluminium, Diffuser + 2x end caps per length	IP20	3 metres
HV9698-6020-3M	3m Length includes aluminium, diffuser + 6x end caps	IP20	3 metres

SAMPLE INSTALLATION METHOD

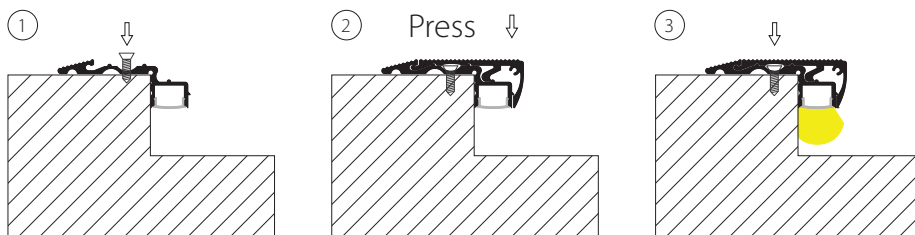

For detailed product specifications
visit www.Havit.com.au
or scan this QR code



- Aluminium profile for LED strip
- Shallow square profile
- UV Stabilised PC diffuser
- Supplied 2m lengths with 4 x end caps & 4 x mounting clips.



PROFILE & STRIP COMPATIBILITY
Scan to view all compatible LED Strip models
www.havit.com.au/PCC

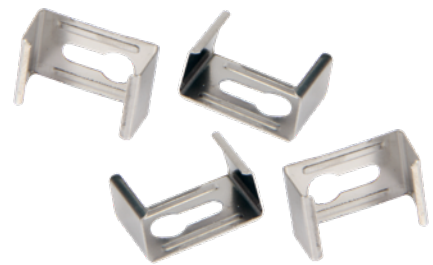
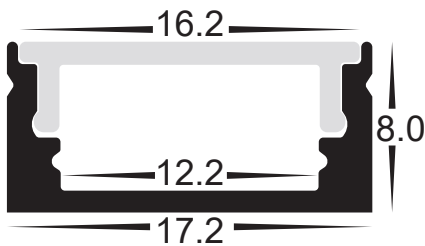

PART NUMBER	DESCRIPTION	IP RATING	LENGTH
HV9699-1708-2M	17 x 8mm shallow square profile with UV Stabilised PC diffuser - 2 metre length	IP20	2 metres



- Aluminium profile for LED strip
- Shallow winged square profile
- UV Stabilised PC diffuser
- Suitable for recessed installation
- Supplied 2m lengths with 4 x end caps & 4 x mounting clips.



PROFILE & STRIP COMPATIBILITY
Scan to view all compatible LED Strip models
www.havit.com.au/PCC

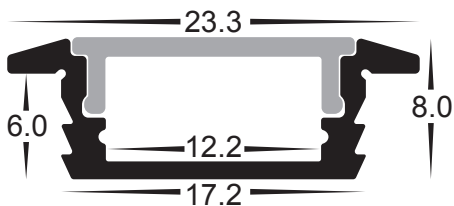

PART NUMBER	DESCRIPTION	IP RATING	LENGTH
HV9699-2308-2M	23mm x 8mm shallow winged profile with UV Stabilised PC diffuser - 2 metre length	IP20	2 metres



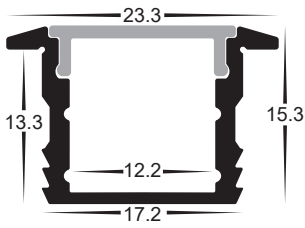

PROFILE & STRIP COMPATIBILITY
Scan to view all compatible LED Strip models
www.havit.com.au/PCC



- Aluminium profile for LED strip
- Deep winged square profile
- UV Stabilised PC diffuser
- Suitable for recessed installation
- Supplied 2m lengths with 4 x end caps & 4 x mounting clips.



PART NUMBER	DESCRIPTION	IP RATING	LENGTH
HV9699-2315-2M	23mm x 15mm deep winged profile with UV Stabilised PC diffuser - 2 metre length	IP20	2 metres

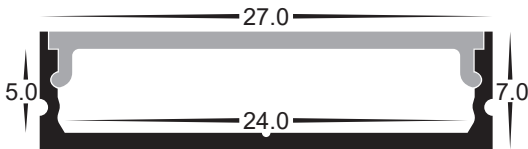

PROFILE & STRIP COMPATIBILITY
Scan to view all compatible LED Strip models
www.havit.com.au/PCC



- Aluminium profile for LED strip
- Shallow double square profile
- UV Stabilised PC diffuser
- Supplied 2m lengths with 4 x end caps & 4 x mounting clips.

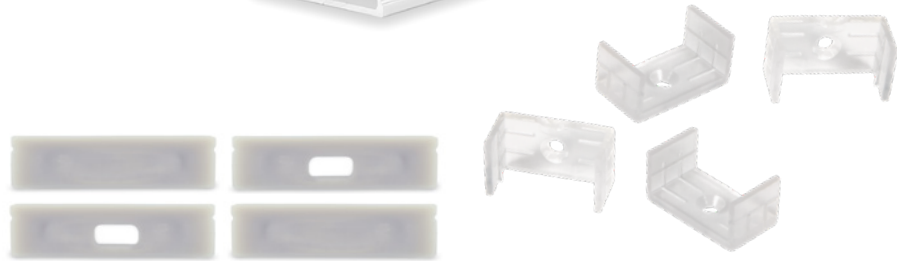

PART NUMBER	DESCRIPTION	IP RATING	LENGTH
HV9699-2707-2M	27mm x 7mm shallow square profile with UV Stabilised PC diffuser - 2 metre length	IP20	2 metres

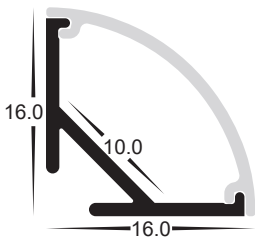

PROFILE & STRIP COMPATIBILITY
Scan to view all compatible LED Strip models
www.havit.com.au/PCC



- Aluminium profile for LED strip
- 90 degree corner profile
- UV Stabilised PC diffuser
- Supplied 2m lengths with 4 x end caps & 4 x mounting clips.



PART NUMBER	DESCRIPTION	IP RATING	LENGTH
HV9699-1616-2M	16mm x 16mm corner profile with UV Stabilised PC diffuser - 2 metre length	IP20	2 metres



For detailed product specifications visit www.Havit.com.au or scan this QR code

LED Profile Suspension Kit

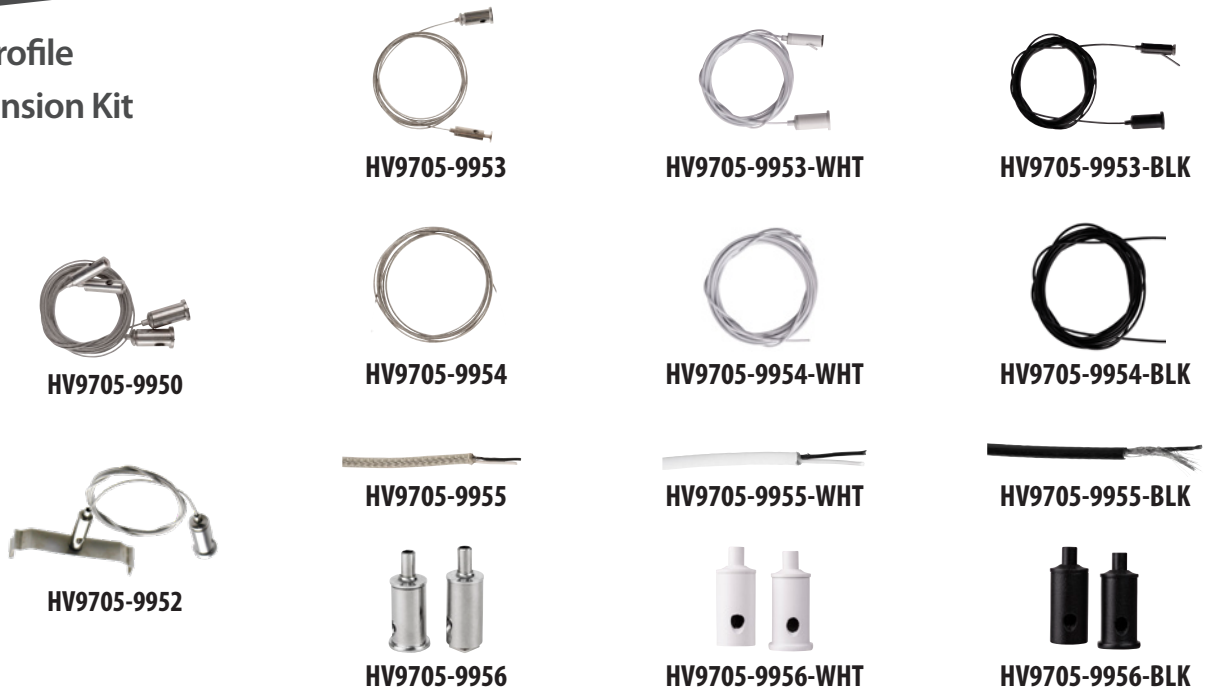

PART NUMBER	DESCRIPTION	IP RATING	MAX LENGTH
HV9705-9950	2 Metre Suspension kit	IP20	2 Metres
HV9705-9951	2 Metre Suspension kit	IP20	2 Metres
HV9705-9952	2 Metre Suspension kit to suit HV9693-6080	IP20	2 Metres
HV9705-9953	2 Metre Suspension kit	IP20	2 Metres
HV9705-9953-BLK	Black 2 Metre Suspension kit	IP20	2 Metres
HV9705-9953-WHT	White 2 Metre Suspension kit	IP20	2 Metres
HV9705-9954	Suspension Cable to Suit Suspension Kits	IP20	100 Metres
HV9705-9954-BLK	Black Suspension Cable to Suit Suspension Kits	IP20	100 Metres
HV9705-9954-WHT	White Suspension Cable to Suit Suspension Kits	IP20	100 Metres
HV9705-9955	2 Core Powered Suspension Cable to Suit HV9705-9956	IP20	100 Metres
HV9705-9955-BLK	2 Core Powered Suspension Cable to Suit HV9705-9956-BLK	IP20	100 Metres
HV9705-9955-WHT	2 Core Powered Suspension Cable to Suit HV9705-9956-WHT	IP20	100 Metres
HV9705-9956	Suspension Kit to suit HV9705-9955	IP20	N/A
HV9705-9956-BLK	Suspension Kit to suit HV9705-9955-BLK	IP20	N/A
HV9705-9956-WHT	Suspension Kit to suit HV9705-9955-WHT	IP20	N/A

10mm Aluminum Heat Sink

- Heat dissipating surface to suit Havit LED strip

PART NUMBER	DESCRIPTION	IP RATING	MAX LENGTH
HV9705-1003	10mm x 3mm Aluminum Heat Sink	IP20	3 metres

16mm Aluminum Heat Sink

- Heat dissipating surface to suit Havit LED strip

PART NUMBER	DESCRIPTION	IP RATING	MAX LENGTH
HV9705-1603	16mm x 3mm Aluminum Heat Sink	IP20	3 metres

20mm Aluminum Heat Sink

- Heat dissipating surface to suit Havit LED strip

PART NUMBER	DESCRIPTION	IP RATING	MAX LENGTH
HV9705-2003	20mm x 3mm Aluminum Heat Sink	IP20	3 metres



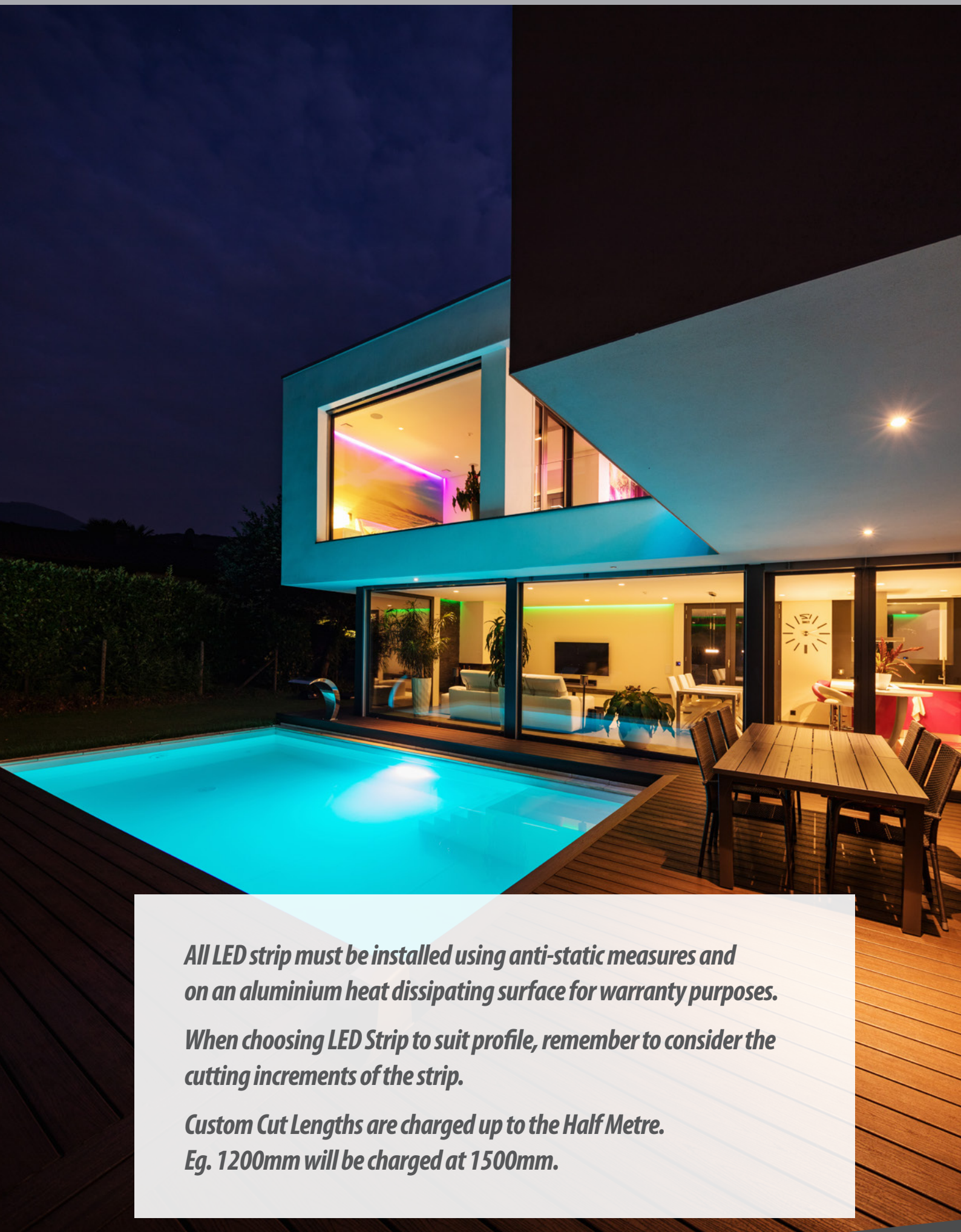

All LED strip must be installed using anti-static measures and on an aluminium heat dissipating surface for warranty purposes.

When choosing LED Strip to suit profile, remember to consider the cutting increments of the strip.

***Custom Cut Lengths are charged up to the Half Metre.
Eg. 1200mm will be charged at 1500mm.***





10 Metre Long Run LED Strip Lighting 30 Metre Rolls

3000K - CRI: ≥90 - IP20 INDOOR - 30 METRE ROLL									
IMAGE	PART NUMBER	SMD	LED PER METRE	LUMENS PER METRE	VOLTAGE	WATTAGE PER METRE	MAX LENGTH	CUTTING INCREMENT	SIZE WxH (mm)
	HV9722-IP20-64-3K-30M	2835	64	595lm	24v DC	4.8w/m	10m	125mm	8x2
	HV9722-IP20-128-3K-30M	2835	128	1280lm	24v DC	9.6w/m	10m	63mm	8x2
	HV9782-IP20-80-3K-30M	2835	80	1700lm	24v DC	14.4w/m	10m	125mm	10x2
4000K - CRI: ≥90 - IP20 INDOOR - 30 METRE ROLL									
IMAGE	PART NUMBER	SMD	LED PER METRE	LUMENS PER METRE	VOLTAGE	WATTAGE PER METRE	MAX LENGTH	CUTTING INCREMENT	SIZE WxH (mm)
	HV9722-IP20-64-4K-30M	2835	64	700lm	24v DC	4.8w/m	10m	125mm	8x2
	HV9722-IP20-128-4K-30M	2835	128	1375lm	24v DC	9.6w/m	10m	63mm	8x2
	HV9782-IP20-80-4K-30M	2835	80	1860lm	24v DC	14.4w/m	10m	125mm	10x2
5500K - CRI: ≥90 - IP20 INDOOR - 30 METRE ROLL									
IMAGE	PART NUMBER	SMD	LED PER METRE	LUMENS PER METRE	VOLTAGE	WATTAGE PER METRE	MAX LENGTH	CUTTING INCREMENT	SIZE WxH (mm)
	HV9722-IP20-64-5K-30M	2835	64	620lm	24v DC	4.8w/m	10m	125mm	8x2
	HV9722-IP20-128-5K-30M	2835	128	1240lm	24v DC	9.6w/m	10m	63mm	8x2
	HV9782-IP20-80-5K-30M	2835	80	1700lm	24v DC	14.4w/m	10m	125mm	10x2

20 Metre Long Run LED Strip Lighting 30 Metre Rolls

3000K, 4000K & 5500K - CRI: ≥90 - IP20 INDOOR - 30 METRE ROLL									
IMAGE	PART NUMBER	SMD	LED PER METRE	LUMENS PER METRE	VOLTAGE	WATTAGE PER METRE	MAX LENGTH	CUTTING INCREMENT	SIZE WxH (mm)
	HV9741-IP20-60-3K-30M	3040	60	450LM	24v DC	4.8w/m	20m	100mm	10x2
	HV9741-IP20-60-4K-30M	3040	60	475LM	24v DC	4.8w/m	20m	100mm	10x2
	HV9741-IP20-60-5K-30M	3040	60	500LM	24v DC	4.8w/m	20m	100mm	10x2



Long Run LED Strip Lighting

- LED flexible strip light
- Maximum length of 10m/20m
- Up to 130lm per watt
- Dimmable
- Peel and stick backing for initial placement
- Beam angle 120 degrees



Scan QR Code
For Havit LED Profile
Compatibility Chart
www.Havit.com.au/PCC



10 Metre Long Run LED Strip Lighting

3000K - CRI: ≥90 - IP20 INDOOR - CUSTOM CUT TO LENGTH

IMAGE	PART NUMBER	SMD	LED PER METRE	LUMENS PER METRE	VOLTAGE	WATTAGE PER METRE	MAX LENGTH	CUTTING INCREMENT	SIZE WxH (mm)
	HV9722-IP20-64-3K	2835	64	595lm	24v DC	4.8w/m	10m	125mm	8x2
	HV9722-IP20-128-3K	2835	128	1280lm	24v DC	9.6w/m	10m	63mm	8x2
	HV9782-IP20-80-3K	2835	80	1700lm	24v DC	14.4w/m	10m	125mm	10x2

4000K - CRI: ≥90 - IP20 INDOOR - CUSTOM CUT TO LENGTH

IMAGE	PART NUMBER	SMD	LED PER METRE	LUMENS PER METRE	VOLTAGE	WATTAGE PER METRE	MAX LENGTH	CUTTING INCREMENT	SIZE WxH (mm)
	HV9722-IP20-64-4K	2835	64	700lm	24v DC	4.8w/m	10m	125mm	8x2
	HV9722-IP20-128-4K	2835	128	1375lm	24v DC	9.6w/m	10m	63mm	8x2
	HV9782-IP20-80-4K	2835	80	1860lm	24v DC	14.4w/m	10m	125mm	10x2

5500K - CRI: ≥90 - IP20 INDOOR - CUSTOM CUT TO LENGTH

IMAGE	PART NUMBER	SMD	LED PER METRE	LUMENS PER METRE	VOLTAGE	WATTAGE PER METRE	MAX LENGTH	CUTTING INCREMENT	SIZE WxH (mm)
	HV9722-IP20-64-5K	2835	64	620lm	24v DC	4.8w/m	10m	125mm	8x2
	HV9722-IP20-128-5K	2835	128	1240lm	24v DC	9.6w/m	10m	63mm	8x2
	HV9782-IP20-80-5K	2835	80	1700lm	24v DC	14.4w/m	10m	125mm	10x2

20 Metre Long Run LED Strip Lighting

3000K, 4000K & 5500K - CRI: ≥90 - IP20 INDOOR - CUSTOM CUT TO LENGTH

IMAGE	PART NUMBER	SMD	LED PER METRE	LUMENS PER METRE	VOLTAGE	WATTAGE PER METRE	MAX LENGTH	CUTTING INCREMENT	SIZE WxH (mm)
	HV9741-IP20-60-3K	3040	60	450LM	24v DC	4.8w/m	20m	100mm	10x2
	HV9741-IP20-60-4K	3040	60	475LM	24v DC	4.8w/m	20m	100mm	10x2
	HV9741-IP20-60-5K	3040	60	500LM	24v DC	4.8w/m	20m	100mm	10x2



For detailed product specifications
visit www.Havit.com.au
or scan this QR code



Scan QR Code
For Havit LED Profile
Compatibility Chart
www.Havit.com.au/PCC

3000K - IP20 INDOOR - CUSTOM CUT TO LENGTH

IMAGE	PART NUMBER	CHIP TYPE	IP RATING	LED PER METRE	LUMENS PER METRE	WATTAGE PER METRE	VOLTAGE	MAX LENGTH	CUTTING INCREMENT	SIZE WxH (MM)
	HV9760-IP20-320-3K	COB	IP20	320	400lm	4.8w/m	24v DC	5M	50mm	8x2
	HV9761-IP20-320-3K	COB	IP20	320	800lm	9.6w/m	24v DC	5M	50mm	8x2
	HV9762-IP20-320-3K	CSP	IP20	320	1000lm	10w/m	24v DC	5M	50mm	8x2
	HV9762-IP20-480-3K	CSP	IP20	480	1325lm	14.4w/m	24v DC	5M	50mm	8x2
	HV9723-IP20-240-3K-1	3528	IP20	240	1560lm	19.2w/m	24v DC	5M	25mm	10x2
	HV9723-IP20-240-3K-2	3528	IP20	240	1560lm	19.2w/m	24v DC	5M	25mm	14x2
	HV9783-IP20-120-3K	2835	IP20	120	1920lm	24w/m	24v DC	5M	25mm	10x2
	HV9783-IP20-168-3K	2835	IP20	168	3260lm	32.6w/m	24v DC	5M	83mm	19x2
	HV9783-IP20-252-3K	2835	IP20	252	4140lm	46w	24v DC	3M	83mm	39x2

3000K - IP54 WATER RESISTANT - CUSTOM CUT TO LENGTH

IMAGE	PART NUMBER	CHIP TYPE	IP RATING	LED PER METRE	LUMENS PER METRE	WATTAGE PER METRE	VOLTAGE	MAX LENGTH	CUTTING INCREMENT	SIZE WxH (MM)
	HV9760-IP54-320-3K	COB	IP54	320	400lm	4.8w/m	24v DC	5M	50mm	8x3
	HV9761-IP54-320-3K	COB	IP54	320	800lm	9.6w/m	24v DC	5M	50mm	8x3
	HV9762-IP54-320-3K	CSP	IP54	320	1000lm	10w/m	24v DC	5M	50mm	8x3
	HV9762-IP54-480-3K	CSP	IP54	480	1325lm	14.4w/m	24v DC	5M	50mm	8x3
	HV9723-IP54-240-3K-1	3528	IP54	240	1560lm	19.2w/m	24v DC	5M	50mm	10x3

3000K - IP67 WEATHERPROOF - CUSTOM CUT TO LENGTH

IMAGE	PART NUMBER	CHIP TYPE	IP RATING	LED PER METRE	LUMENS PER METRE	WATTAGE PER METRE	VOLTAGE	MAX LENGTH	CUTTING INCREMENT	SIZE WxH (MM)
	HV9760-IP67-320-3K	COB	IP67	320	400lm	4.8w/m	24v DC	5M	50mm	12x4
	HV9761-IP67-320-3K	COB	IP67	320	800lm	9.6w/m	24v DC	5M	50mm	12x4
	HV9762-IP67-320-3K	CSP	IP67	320	1000lm	10w/m	24v DC	5M	50mm	12x4
	HV9762-IP67-480-3K	CSP	IP67	480	1325lm	14.4w/m	24v DC	5M	50mm	12x4
	HV9723-IP67-240-3K-1	3528	IP67	240	1560lm	19.2w/m	24v DC	5M	50mm	14x6



3000K LED Strip Lighting

- LED flexible strip light
- Dimmable
- Peel and stick backing for initial placement
- Beam angle 120 degrees



3000K - IP20 INDOOR - 30M REEL

IMAGE	PART NUMBER	CHIP TYPE	IP RATING	LED PER METRE	LUMENS PER METRE	WATTAGE PER METRE	VOLTAGE	MAX LENGTH	CUTTING INCREMENT	SIZE WxH (MM)
	HV9760-IP20-320-3K-30M	COB	IP20	320	400lm	4.8w/m	24v DC	5M	50mm	8x2
	HV9761-IP20-320-3K-30M	COB	IP20	320	800lm	9.6w/m	24v DC	5M	50mm	8x2
	HV9762-IP20-320-3K-30M	CSP	IP20	320	1000lm	10w/m	24v DC	5M	50mm	8x2
	HV9762-IP20-480-3K-30M	CSP	IP20	480	1325lm	14.4w/m	24v DC	5M	50mm	8x2
	HV9723-IP20-240-3K-1-30M	3528	IP20	240	1560lm	19.2w/m	24v DC	5M	25mm	10x2
	HV9723-IP20-240-3K-2-30M	3528	IP20	240	1560lm	19.2w/m	24v DC	5M	25mm	14x2
	HV9783-IP20-120-3K-30M	2835	IP20	120	1920lm	24w/m	24v DC	5M	25mm	10x2

3000K - IP20 INDOOR - 20M REEL

IMAGE	PART NUMBER	CHIP TYPE	IP RATING	LED PER METRE	LUMENS PER METRE	WATTAGE PER METRE	VOLTAGE	MAX LENGTH	CUTTING INCREMENT	SIZE WxH (MM)
	HV9783-IP20-168-3K-20M	2835	IP20	168	3260lm	32.6w/m	24v DC	5M	83mm	19x2

3000K - IP20 INDOOR - 5M REEL

IMAGE	PART NUMBER	CHIP TYPE	IP RATING	LED PER METRE	LUMENS PER METRE	WATTAGE PER METRE	VOLTAGE	MAX LENGTH	CUTTING INCREMENT	SIZE WxH (MM)
	HV9783-IP20-252-3K-5M	2835	IP20	252	4140lm	46w	24v DC	3M	83mm	39x2

3000K - IP54 WATER RESISTANT - 10M REEL

IMAGE	PART NUMBER	CHIP TYPE	IP RATING	LED PER METRE	LUMENS PER METRE	WATTAGE PER METRE	VOLTAGE	MAX LENGTH	CUTTING INCREMENT	SIZE WxH (MM)
	HV9760-IP54-320-3K-10M	COB	IP54	320	400lm	4.8w/m	24v DC	5M	50mm	8x3
	HV9761-IP54-320-3K-10M	COB	IP54	320	800lm	9.6w/m	24v DC	5M	50mm	8x3
	HV9762-IP54-320-3K-10M	CSP	IP54	320	1000lm	10w/m	24v DC	5M	50mm	8x3
	HV9762-IP54-480-3K-10M	CSP	IP54	480	1325lm	14.4w/m	24v DC	5M	50mm	8x3
	HV9723-IP54-240-3K-1-10M	3528	IP54	240	1560lm	19.2w/m	24v DC	5M	25mm	10x3

3000K - IP67 WEATHERPROOF - 10M REEL

IMAGE	PART NUMBER	CHIP TYPE	IP RATING	LED PER METRE	LUMENS PER METRE	WATTAGE PER METRE	VOLTAGE	MAX LENGTH	CUTTING INCREMENT	SIZE WxH (MM)
	HV9760-IP67-320-3K-10M	COB	IP67	320	400lm	4.8w/m	24v DC	5M	50mm	12x4
	HV9761-IP67-320-3K-10M	COB	IP67	320	800lm	9.6w/m	24v DC	5M	50mm	12x4
	HV9762-IP67-320-3K-10M	CSP	IP67	320	1000lm	10w/m	24v DC	5M	50mm	12x4
	HV9762-IP67-480-3K-10M	CSP	IP67	480	1325lm	14.4w/m	24v DC	5M	50mm	12x4
	HV9723-IP67-240-3K-1-10M	3528	IP67	240	1560lm	19.2w/m	24v DC	5M	25mm	14x6



For detailed product specifications
visit www.Havit.com.au
or scan this QR code

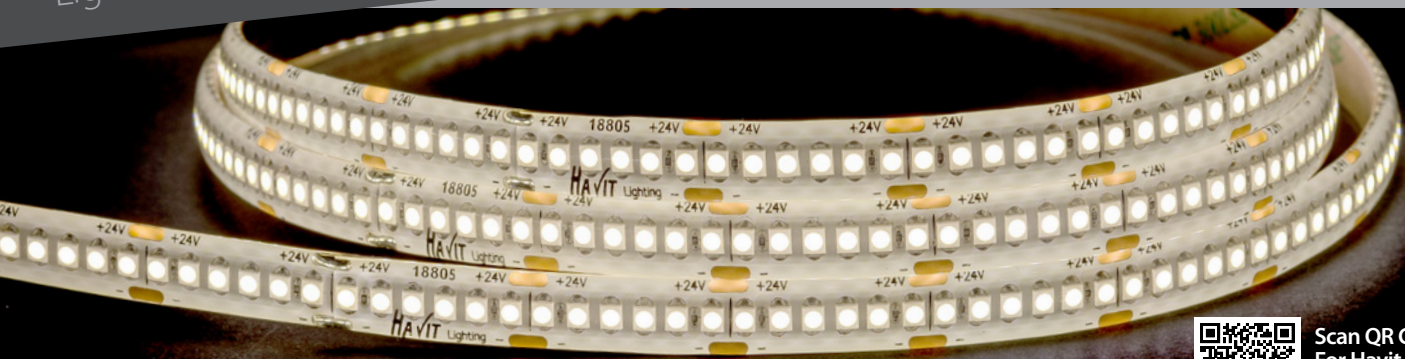

Scan QR Code
For Havit LED Profile
Compatibility Chart
www.Havit.com.au/PCC

4000K - IP20 INDOOR - CUSTOM CUT TO LENGTH

IMAGE	PART NUMBER	CHIP TYPE	IP RATING	LED PER METRE	LUMENS PER METRE	WATTAGE PER METRE	VOLTAGE	MAX LENGTH	CUTTING INCREMENT	SIZE WxH (MM)
	HV9760-IP20-320-4K	COB	IP20	320	405lm	4.8w/m	24v DC	5M	50mm	8x2
	HV9761-IP20-320-4K	COB	IP20	320	810lm	9.6w/m	24v DC	5M	50mm	8x2
	HV9762-IP20-320-4K	CSP	IP20	320	1035lm	10w/m	24v DC	5M	50mm	8x2
	HV9762-IP20-480-4K	CSP	IP20	480	1365lm	14.4w/m	24v DC	5M	50mm	8x2
	HV9723-IP20-240-4K-1	3528	IP20	240	1640lm	19.2w/m	24v DC	5M	25mm	10x2
	HV9723-IP20-240-4K-2	3528	IP20	240	1640lm	19.2w/m	24v DC	5M	25mm	14x2
	HV9783-IP20-120-4K	2835	IP20	120	2040lm	24w/m	24v DC	5M	25mm	10x2
	HV9783-IP20-168-4K	2835	IP20	168	3750lm	32.6w/m	24v DC	5M	83mm	19x2
	HV9783-IP20-252-4K	2835	IP20	252	4370lm	46w	24v DC	3M	83mm	39x2

4000K - IP54 WATER RESISTANT - CUSTOM CUT TO LENGTH

IMAGE	PART NUMBER	CHIP TYPE	IP RATING	LED PER METRE	LUMENS PER METRE	WATTAGE PER METRE	VOLTAGE	MAX LENGTH	CUTTING INCREMENT	SIZE WxH (MM)
	HV9760-IP54-320-4K	COB	IP54	320	405lm	4.8w/m	24v DC	5M	50mm	8x3
	HV9761-IP54-320-4K	COB	IP54	320	810lm	9.6w/m	24v DC	5M	50mm	8x3
	HV9762-IP54-320-4K	CSP	IP54	320	1035lm	10w/m	24v DC	5M	50mm	8x3
	HV9762-IP54-480-4K	CSP	IP54	480	1365lm	14.4w/m	24v DC	5M	50mm	8x3
	HV9723-IP54-240-4K-1	3528	IP54	240	1640lm	19.2w/m	24v DC	5M	50mm	10x3

4000K - IP67 WEATHERPROOF - CUSTOM CUT TO LENGTH

IMAGE	PART NUMBER	CHIP TYPE	IP RATING	LED PER METRE	LUMENS PER METRE	WATTAGE PER METRE	VOLTAGE	MAX LENGTH	CUTTING INCREMENT	SIZE WxH (MM)
	HV9760-IP67-320-4K	COB	IP67	320	405lm	4.8w/m	24v DC	5M	50mm	12x4
	HV9761-IP67-320-4K	COB	IP67	320	810lm	9.6w/m	24v DC	5M	50mm	12x4
	HV9762-IP67-320-4K	CSP	IP67	320	1035lm	10w/m	24v DC	5M	50mm	12x4
	HV9762-IP67-480-4K	CSP	IP67	480	1365lm	14.4w/m	24v DC	5M	50mm	12x4
	HV9723-IP67-240-4K-1	3528	IP67	240	1640lm	19.2w/m	24v DC	5M	50mm	14x6



4000K LED Strip Lighting

- LED flexible strip light
- Dimmable
- Peel and stick backing for initial placement
- Beam angle 120 degrees



4000K - IP20 INDOOR - 30M REEL

IMAGE	PART NUMBER	CHIP TYPE	IP RATING	LED PER METRE	LUMENS PER METRE	WATTAGE PER METRE	VOLTAGE	MAX LENGTH	CUTTING INCREMENT	SIZE WxH (MM)
	HV9760-IP20-320-4K-30M	COB	IP20	320	405lm	4.8w/m	24v DC	5M	50mm	8x2
	HV9761-IP20-320-4K-30M	COB	IP20	320	810lm	9.6w/m	24v DC	5M	50mm	8x2
	HV9762-IP20-320-4K-30M	CSP	IP20	320	1000lm	10w/m	24v DC	5M	50mm	8x2
	HV9762-IP20-480-4K-30M	CSP	IP20	480	1325lm	14.4w/m	24v DC	5M	50mm	8x2
	HV9723-IP20-240-4K-1-30M	3528	IP20	240	1640lm	19.2w/m	24v DC	5M	25mm	10x2
	HV9723-IP20-240-4K-2-30M	3528	IP20	240	1640lm	19.2w/m	24v DC	5M	25mm	14x2
	HV9783-IP20-120-4K-30M	2835	IP20	120	2040lm	24w/m	24v DC	5M	25mm	10x2

4000K - IP20 INDOOR - 20M REEL

IMAGE	PART NUMBER	CHIP TYPE	IP RATING	LED PER METRE	LUMENS PER METRE	WATTAGE PER METRE	VOLTAGE	MAX LENGTH	CUTTING INCREMENT	SIZE WxH (MM)
	HV9783-IP20-168-4K-20M	2835	IP20	168	3750lm	32.6w/m	24v DC	5M	83mm	19x2

4000K - IP20 INDOOR - 5M REEL

IMAGE	PART NUMBER	CHIP TYPE	IP RATING	LED PER METRE	LUMENS PER METRE	WATTAGE PER METRE	VOLTAGE	MAX LENGTH	CUTTING INCREMENT	SIZE WxH (MM)
	HV9783-IP20-252-4K-5M	2835	IP20	252	4370lm	46w	24v DC	3M	83mm	39x2

4000K - IP54 WATER RESISTANT - 10M REEL

IMAGE	PART NUMBER	CHIP TYPE	IP RATING	LED PER METRE	LUMENS PER METRE	WATTAGE PER METRE	VOLTAGE	MAX LENGTH	CUTTING INCREMENT	SIZE WxH (MM)
	HV9760-IP54-320-4K-10M	COB	IP54	320	405lm	4.8w/m	24v DC	5M	50mm	8x3
	HV9761-IP54-320-4K-10M	COB	IP54	320	810lm	9.6w/m	24v DC	5M	50mm	8x3
	HV9762-IP54-320-4K-10M	CSP	IP54	320	1000lm	10w/m	24v DC	5M	50mm	8x3
	HV9762-IP54-480-4K-10M	CSP	IP54	480	1325lm	14.4w/m	24v DC	5M	50mm	8x3
	HV9723-IP54-240-4K-1-10M	3528	IP54	240	1640lm	19.2w/m	24v DC	5M	25mm	10x3

4000K - IP67 WEATHERPROOF - 10M REEL

IMAGE	PART NUMBER	CHIP TYPE	IP RATING	LED PER METRE	LUMENS PER METRE	WATTAGE PER METRE	VOLTAGE	MAX LENGTH	CUTTING INCREMENT	SIZE WxH (MM)
	HV9760-IP67-320-4K-10M	COB	IP67	320	405lm	4.8w/m	24v DC	5M	50mm	12x4
	HV9761-IP67-320-4K-10M	COB	IP67	320	810lm	9.6w/m	24v DC	5M	50mm	12x4
	HV9762-IP67-320-4K-10M	CSP	IP67	320	1000lm	10w/m	24v DC	5M	50mm	12x4
	HV9762-IP67-480-4K-10M	CSP	IP67	480	1325lm	14.4w/m	24v DC	5M	50mm	12x4
	HV9723-IP67-240-4K-1-10M	3528	IP67	240	1640lm	19.2w/m	24v DC	5M	25mm	14x6



For detailed product specifications
visit www.Havit.com.au
or scan this QR code



Scan QR Code
For Havit LED Profile
Compatibility Chart
www.Havit.com.au/PCC

5500K - IP20 INDOOR - CUSTOM CUT TO LENGTH

IMAGE	PART NUMBER	CHIP TYPE	IP RATING	LED PER METRE	LUMENS PER METRE	WATTAGE PER METRE	VOLTAGE	MAX LENGTH	CUTTING INCREMENT	SIZE WxH (MM)
	HV9760-IP20-320-5K	COB	IP20	320	410lm	4.8w/m	24v DC	5M	50mm	8x2
	HV9761-IP20-320-5K	COB	IP20	320	820lm	9.6w/m	24v DC	5M	50mm	8x2
	HV9762-IP20-320-5K	CSP	IP20	320	1030lm	10w/m	24v DC	5M	50mm	8x2
	HV9762-IP20-480-5K	CSP	IP20	480	1340lm	14.4w/m	24v DC	5M	50mm	8x2
	HV9723-IP20-240-5K-1	3528	IP20	240	1720lm	19.2w/m	24v DC	5M	25mm	10x2
	HV9723-IP20-240-5K-2	3528	IP20	240	1720lm	19.2w/m	24v DC	5M	25mm	14x2
	HV9783-IP20-120-5K	2835	IP20	120	2200lm	24w/m	24v DC	5M	25mm	10x2
	HV9783-IP20-168-5K	2835	IP20	168	4075lm	32.6w/m	24v DC	5M	83mm	19x2
	HV9783-IP20-252-5K	2835	IP20	252	4600lm	46w	24v DC	3M	83mm	39x2

5500K - IP54 WATER RESISTANT - CUSTOM CUT TO LENGTH

IMAGE	PART NUMBER	CHIP TYPE	IP RATING	LED PER METRE	LUMENS PER METRE	WATTAGE PER METRE	VOLTAGE	MAX LENGTH	CUTTING INCREMENT	SIZE WxH (MM)
	HV9760-IP54-320-5K	COB	IP54	320	410lm	4.8w/m	24v DC	5M	50mm	8x3
	HV9761-IP54-320-5K	COB	IP54	320	820lm	9.6w/m	24v DC	5M	50mm	8x3
	HV9762-IP54-320-5K	CSP	IP54	320	1030lm	10w/m	24v DC	5M	50mm	8x3
	HV9762-IP54-480-5K	CSP	IP54	480	1340lm	14.4w/m	24v DC	5M	50mm	8x3
	HV9723-IP54-240-5K-1	3528	IP54	240	1720lm	19.2w/m	24v DC	5M	50mm	10x3

5500K - IP67 WEATHERPROOF - CUSTOM CUT TO LENGTH

IMAGE	PART NUMBER	CHIP TYPE	IP RATING	LED PER METRE	LUMENS PER METRE	WATTAGE PER METRE	VOLTAGE	MAX LENGTH	CUTTING INCREMENT	SIZE WxH (MM)
	HV9760-IP67-320-5K	COB	IP67	320	410lm	4.8w/m	24v DC	5M	50mm	12x4
	HV9761-IP67-320-5K	COB	IP67	320	820lm	9.6w/m	24v DC	5M	50mm	12x4
	HV9762-IP67-320-5K	CSP	IP67	320	1030lm	10w/m	24v DC	5M	50mm	12x4
	HV9762-IP67-480-5K	CSP	IP67	480	1340lm	14.4w/m	24v DC	5M	50mm	12x4
	HV9723-IP67-240-5K-1	3528	IP67	240	1720lm	19.2w/m	24v DC	5M	50mm	14x6



5500K LED Strip Lighting

- LED flexible strip light
- Dimmable
- Peel and stick backing for initial placement
- Beam angle 120 degrees



5500K - IP20 INDOOR - 30M REEL

IMAGE	PART NUMBER	CHIP TYPE	IP RATING	LED PER METRE	LUMENS PER METRE	WATTAGE PER METRE	VOLTAGE	MAX LENGTH	CUTTING INCREMENT	SIZE WxH (MM)
	HV9760-IP20-320-5K-30M	COB	IP20	320	410lm	4.8w/m	24v DC	5M	50mm	8x2
	HV9761-IP20-320-5K-30M	COB	IP20	320	820lm	9.6w/m	24v DC	5M	50mm	8x2
	HV9762-IP20-320-5K-30M	CSP	IP20	320	1000lm	10w/m	24v DC	5M	50mm	8x2
	HV9762-IP20-480-5K-30M	CSP	IP20	480	1325lm	14.4w/m	24v DC	5M	50mm	8x2
	HV9723-IP20-240-5K-1-30M	3528	IP20	240	1720lm	19.2w/m	24v DC	5M	25mm	10x2
	HV9723-IP20-240-5K-2-30M	3528	IP20	240	1720lm	19.2w/m	24v DC	5M	25mm	14x2
	HV9783-IP20-120-5K-30M	2835	IP20	120	2200lm	24w/m	24v DC	5M	25mm	10x2

5500K - IP20 INDOOR - 20M REEL

IMAGE	PART NUMBER	CHIP TYPE	IP RATING	LED PER METRE	LUMENS PER METRE	WATTAGE PER METRE	VOLTAGE	MAX LENGTH	CUTTING INCREMENT	SIZE WxH (MM)
	HV9783-IP20-168-5K-20M	2835	IP20	168	4075lm	32.6w/m	24v DC	5M	83mm	19x2

5500K - IP20 INDOOR - 5M REEL

IMAGE	PART NUMBER	CHIP TYPE	IP RATING	LED PER METRE	LUMENS PER METRE	WATTAGE PER METRE	VOLTAGE	MAX LENGTH	CUTTING INCREMENT	SIZE WxH (MM)
	HV9783-IP20-252-5K-5M	2835	IP20	252	4600lm	46w	24v DC	3M	83mm	39x2

5500K - IP54 WATER RESISTANT - 10M REEL

IMAGE	PART NUMBER	CHIP TYPE	IP RATING	LED PER METRE	LUMENS PER METRE	WATTAGE PER METRE	VOLTAGE	MAX LENGTH	CUTTING INCREMENT	SIZE WxH (MM)
	HV9760-IP54-320-5K-10M	COB	IP54	320	410lm	4.8w/m	24v DC	5M	50mm	8x3
	HV9761-IP54-320-5K-10M	COB	IP54	320	820lm	9.6w/m	24v DC	5M	50mm	8x3
	HV9762-IP54-320-5K-10M	CSP	IP54	320	1000lm	10w/m	24v DC	5M	50mm	8x3
	HV9762-IP54-480-5K-10M	CSP	IP54	480	1325lm	14.4w/m	24v DC	5M	50mm	8x3
	HV9723-IP54-240-5K-1-10M	3528	IP54	240	1720lm	19.2w/m	24v DC	5M	25mm	10x3

5500K - IP67 WEATHERPROOF - 10M REEL

IMAGE	PART NUMBER	CHIP TYPE	IP RATING	LED PER METRE	LUMENS PER METRE	WATTAGE PER METRE	VOLTAGE	MAX LENGTH	CUTTING INCREMENT	SIZE WxH (MM)
	HV9760-IP67-320-5K-10M	COB	IP67	320	410lm	4.8w/m	24v DC	5M	50mm	12x4
	HV9761-IP67-320-5K-10M	COB	IP67	320	820lm	9.6w/m	24v DC	5M	50mm	12x4
	HV9762-IP67-320-5K-10M	CSP	IP67	320	1000lm	10w/m	24v DC	5M	50mm	12x4
	HV9762-IP67-480-5K-10M	CSP	IP67	480	1325lm	14.4w/m	24v DC	5M	50mm	12x4
	HV9723-IP67-240-5K-1-10M	3528	IP67	240	1720lm	19.2w/m	24v DC	5M	25mm	14x6



For detailed product specifications
visit www.Havit.com.au
or scan this QR code

50 Metre Rolls

- LED flexible strip light 50m roll
- Dimmable
- Peel and stick backing for initial placement
- Beam angle 120 degrees
- Supplied with 25x easy connect tails



Scan QR Code
For Havit LED Profile
Compatibility Chart
www.Havit.com.au/PCC



3000K COB - IP20 INDOOR - 50M ROLL

IMAGE	PART NUMBER	CHIP TYPE	IP RATING	LED PER METRE	LUMENS PER METRE	WATTAGE PER METRE	VOLTAGE	MAX LENGTH	CUTTING INCREMENT	SIZE WxH (MM)
	HV9760-IP20-320-3K-50M	COB	IP20	320	400lm	4.8w/m	24v DC	5M	50mm	8x2
	HV9761-IP20-320-3K-50M	COB	IP20	320	800lm	9.6w/m	24v DC	5M	50mm	8x2

4000K COB - IP20 INDOOR - 50M ROLL

IMAGE	PART NUMBER	CHIP TYPE	IP RATING	LED PER METRE	LUMENS PER METRE	WATTAGE PER METRE	VOLTAGE	MAX LENGTH	CUTTING INCREMENT	SIZE WxH (MM)
	HV9760-IP20-320-4K-50M	COB	IP20	320	405lm	4.8w/m	24v DC	5M	50mm	8x2
	HV9761-IP20-320-4K-50M	COB	IP20	320	810lm	9.6w/m	24v DC	5M	50mm	8x2

5500K COB - IP20 INDOOR - 50M ROLL

IMAGE	PART NUMBER	CHIP TYPE	IP RATING	LED PER METRE	LUMENS PER METRE	WATTAGE PER METRE	VOLTAGE	MAX LENGTH	CUTTING INCREMENT	SIZE WxH (MM)
	HV9760-IP20-320-5K-50M	COB	IP20	320	410lm	4.8w/m	24v DC	5M	50mm	8x2
	HV9761-IP20-320-5K-50M	COB	IP20	320	820lm	9.6w/m	24v DC	5M	50mm	8x2

HAVIT COMPATIBLE ACCESSORIES



See pages 295-306 for compatible drivers.
All low voltage products that specify an input of 12v or 24v DC must be used with a suitable LED driver.

ALL LED STRIP MUST BE INSTALLED ON AN ALUMINIUM HEAT DISSIPATING SURFACE



HV9705-1003 10mm x 3mm Aluminum Heat Sink per metre (Max: 3 metre length)



LED Strip Crimp Connectors

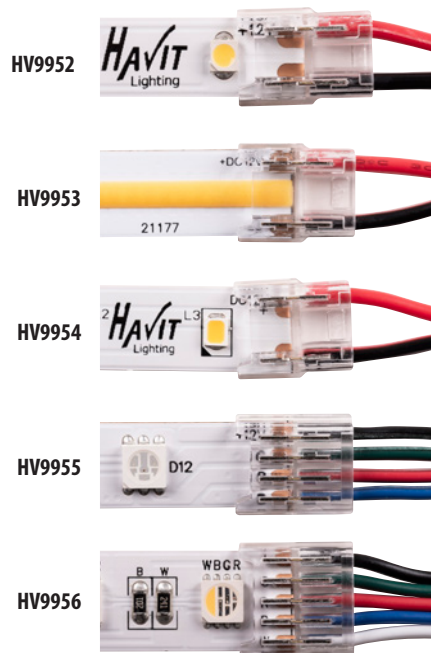

LED Strip Crimp Joiners



- No need for Soldering
- Quick and Easy
- IP Rating: IP20

LED strip crimp connectors are small devices used to connect and secure LED strips. They are designed to simplify the installation process by eliminating the need for soldering. These connectors consist of two main components—a male and a female end with metal pins that align and securely grip the corresponding contacts on the LED strip.

To use a crimp connector, you would typically cut the LED strip to the desired length, exposing the copper pads on the cut end. Then, you insert the exposed pads into the connector, ensuring that the positive and negative ends align correctly. The connector is equipped with a clamping mechanism that holds the pads in place, establishing a secure electrical connection.

Crimp connectors offer several advantages. First, they provide a quick and easy way to connect LED strips, saving time and effort during installation. Additionally, they offer a reliable and secure connection, ensuring proper electrical conductivity. This is crucial for maintaining the functionality and longevity of the LED strip.

When using crimp connectors, it's important to choose connectors that are compatible with your specific LED strip model and size.

Overall, LED strip crimp connectors provide a convenient and efficient solution for connecting LED strips, offering a hassle-free installation process and reliable electrical connections.

IMAGE	PART NUMBER	DESCRIPTION	IP RATING
	HV9952	LED Strip Connector to suit 8mm PCB IP20 LED Strip	IP20
	HV9953	LED Strip Connector to suit 10mm PCB IP20 COB LED Strip	IP20
	HV9954	LED Strip Connector to suit 10mm PCB IP20 LED Strip	IP20
	HV9955	LED Strip Connector to suit 10mm PCB IP20 RGB LED Strip	IP20
	HV9956	LED Strip Connector to suit 12mm PCB IP20 RGBC or RGBW LED Strip	IP20
	HV9959	LED Strip Straight Connector to suit 8mm PCB IP20 LED Strip	IP20
	HV9960	LED Strip Straight Connector to suit 10mm PCB IP20 COB LED Strip	IP20
	HV9961	LED Strip Straight Connector to suit 10mm PCB IP20 LED Strip	IP20
	HV9962	LED Strip Straight Connector to suit 10mm PCB IP20 RGB LED Strip	IP20
	HV9963	LED Strip Straight Connector to suit 12mm PCB IP20 RGBC or RGBW LED Strip	IP20



For detailed product specifications
visit www.Havit.com.au
or scan this QR code



Scan QR Code
For Havit LED Profile
Compatibility Chart
www.Havit.com.au/PCC

Micro LED Strip Lighting 30 Metre Rolls

- LED flexible strip light
- Dimmable
- Peel and stick backing for initial placement
- Beam angle 120 degrees



3000K - IP20 INDOOR - 30 METRE ROLL

IMAGE	PART NUMBER	SMD	LED PER METRE	LUMENS PER METRE	VOLTAGE	WATTAGE PER METRE	MAX LENGTH	CUTTING INCREMENT	SIZE WxH (mm)
	HV9731-IP20-180-3K-30M	2216	180	390lm	24v DC	4.8w/m	5m	33mm	4x2
	HV9733-IP20-180-3K-30M	2216	180	780lm	24v DC	9.6w/m	5m	33mm	4x2
	HV9734-IP20-240-3K-30M	2216	240	1150lm	24v DC	14.4w/m	5m	25mm	4x2
	HV9735-IP20-240-3K-30M	2216	240	1500lm	24v DC	19.2w/m	5m	25mm	4x2

4000K - IP20 INDOOR - 30 METRE ROLL

IMAGE	PART NUMBER	SMD	LED PER METRE	LUMENS PER METRE	VOLTAGE	WATTAGE PER METRE	MAX LENGTH	CUTTING INCREMENT	SIZE WxH (mm)
	HV9731-IP20-180-4K-30M	2216	180	410lm	24v DC	4.8w/m	5m	33mm	4x2
	HV9733-IP20-180-4K-30M	2216	180	820lm	24v DC	9.6w/m	5m	33mm	4x2
	HV9734-IP20-240-4K-30M	2216	240	1175lm	24v DC	14.4w/m	5m	25mm	4x2
	HV9735-IP20-240-4K-30M	2216	240	1600lm	24v DC	19.2w/m	5m	25mm	4x2

5500K - IP20 INDOOR - 30 METRE ROLL

IMAGE	PART NUMBER	SMD	LED PER METRE	LUMENS PER METRE	VOLTAGE	WATTAGE PER METRE	MAX LENGTH	CUTTING INCREMENT	SIZE WxH (mm)
	HV9731-IP20-180-5K-30M	2216	180	430lm	24v DC	4.8w/m	5m	33mm	4x2
	HV9733-IP20-180-5K-30M	2216	180	860lm	24v DC	9.6w/m	5m	33mm	4x2
	HV9734-IP20-240-5K-30M	2216	240	1200lm	24v DC	14.4w/m	5m	25mm	4x2
	HV9735-IP20-240-5K-30M	2216	240	1600lm	24v DC	19.2w/m	5m	25mm	4x2

HAVIT COMPATIBLE ACCESSORIES

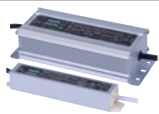

See pages 295-306 for compatible drivers.
All low voltage products that specify an input of 12v or 24v DC must be used with a suitable LED driver.

ALL LED STRIP MUST BE INSTALLED ON AN ALUMINIUM HEAT DISSIPATING SURFACE



HV9705-1003
10mm x 3mm Aluminum Heat Sink per metre (Max: 3 metre length)





Scan QR Code
For Havit LED Profile
Compatibility Chart
www.Havit.com.au/PCC

Micro LED Strip Lighting

- LED flexible strip light
- Dimmable
- Peel and stick backing for initial placement
- Beam angle 120 degrees



3000K - IP20 INDOOR - CUSTOM CUT TO LENGTH

IMAGE	PART NUMBER	SMD	LED PER METRE	LUMENS PER METRE	VOLTAGE	WATTAGE PER METRE	MAX LENGTH	CUTTING INCREMENT	SIZE WxH (mm)
	HV9731-IP20-180-3K	2216	180	390lm	24v DC	4.8w/m	5m	33mm	4x2
	HV9733-IP20-180-3K	2216	180	780lm	24v DC	9.6w/m	5m	33mm	4x2
	HV9734-IP20-240-3K	2216	240	1150lm	24v DC	14.4w/m	5m	25mm	4x2
	HV9735-IP20-240-3K	2216	240	1500lm	24v DC	19.2w/m	5m	25mm	4x2

4000K - IP20 INDOOR - CUSTOM CUT TO LENGTH

IMAGE	PART NUMBER	SMD	LED PER METRE	LUMENS PER METRE	VOLTAGE	WATTAGE PER METRE	MAX LENGTH	CUTTING INCREMENT	SIZE WxH (mm)
	HV9731-IP20-180-4K	2216	180	410lm	24v DC	4.8w/m	5m	33mm	4x2
	HV9733-IP20-180-4K	2216	180	820lm	24v DC	9.6w/m	5m	33mm	4x2
	HV9734-IP20-240-4K	2216	240	1175lm	24v DC	14.4w/m	5m	25mm	4x2
	HV9735-IP20-240-4K	2216	240	1600lm	24v DC	19.2w/m	5m	25mm	4x2

5500K - IP20 INDOOR - CUSTOM CUT TO LENGTH

IMAGE	PART NUMBER	SMD	LED PER METRE	LUMENS PER METRE	VOLTAGE	WATTAGE PER METRE	MAX LENGTH	CUTTING INCREMENT	SIZE WxH (mm)
	HV9731-IP20-180-5K	2216	180	430lm	24v DC	4.8w/m	5m	33mm	4x2
	HV9733-IP20-180-5K	2216	180	860lm	24v DC	9.6w/m	5m	33mm	4x2
	HV9734-IP20-240-5K	2216	240	1200lm	24v DC	14.4w/m	5m	25mm	4x2
	HV9735-IP20-240-5K	2216	240	1600lm	24v DC	19.2w/m	5m	25mm	4x2

HAVIT COMPATIBLE ACCESSORIES



See pages 295-306 for compatible drivers.
All low voltage products that specify an input of 12v or 24v DC must be used with a suitable LED driver.

ALL LED STRIP MUST BE INSTALLED ON AN ALUMINIUM HEAT DISSIPATING SURFACE



HV9705-1003 10mm x 3mm Aluminum Heat Sink per metre (Max: 3 metre length)

CUSTOM CUT ORDERS AVAILABLE

All custom cut orders require minimum of 48hrs production time from order confirmation, plus delivery time.





For detailed product specifications
visit www.Havit.com.au
or scan this QR code



Scan QR Code
For Havit LED Profile
Compatibility Chart
www.Havit.com.au/PCC

Coloured LED Strip Lighting Rolls

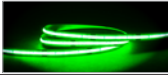
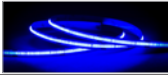
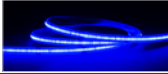
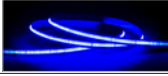
- LED flexible strip light
- Red, Green and Blue
- Dimmable using Havit LED controllers
- Peel and stick backing for initial placement
- Beam angle 120 degrees

COLOURED COB - IP20 INDOOR - CUSTOM CUT TO LENGTH										
IMAGE	PART NUMBER	CHIP TYPE	IP RATING	LED PER METRE	LUMENS PER METRE	WATTAGE PER METRE	VOLTAGE	MAX LENGTH	CUTTING INCREMENT	SIZE WxH (MM)
	HV9761-IP20-320-R	COB	IP20	320	140lm	9.6w/m	24v DC	5M	50mm	8x2
	HV9761-IP20-320-G	COB	IP20	320	250lm	9.6w/m	24v DC	5M	50mm	8x2
	HV9761-IP20-320-B	COB	IP20	320	60lm	9.6w/m	24v DC	5M	50mm	8x2
COLOURED COB - IP54 WATER RESISTANT - CUSTOM CUT TO LENGTH										
IMAGE	PART NUMBER	CHIP TYPE	IP RATING	LED PER METRE	LUMENS PER METRE	WATTAGE PER METRE	VOLTAGE	MAX LENGTH	CUTTING INCREMENT	SIZE WxH (MM)
	HV9761-IP54-320-B	COB	IP20	320	60lm	9.6w/m	24v DC	5M	50mm	8x3
COLOURED COB - IP67 WEATHERPROOF - CUSTOM CUT TO LENGTH										
IMAGE	PART NUMBER	CHIP TYPE	IP RATING	LED PER METRE	LUMENS PER METRE	WATTAGE PER METRE	VOLTAGE	MAX LENGTH	CUTTING INCREMENT	SIZE WxH (MM)
	HV9761-IP67-320-B	COB	IP20	320	60lm	9.6w/m	24v DC	5M	50mm	12x6
HAVIT COMPATIBLE ACCESSORIES										
	See pages 295-306 for compatible drivers. All low voltage products that specify an input of 12v or 24v DC must be used with a suitable LED driver.									
ALL LED STRIP MUST BE INSTALLED ON AN ALUMINIUM HEAT DISSIPATING SURFACE										
	HV9705-1003	10mm x 3mm Aluminum Heat Sink per metre (Max: 3 metre length)								



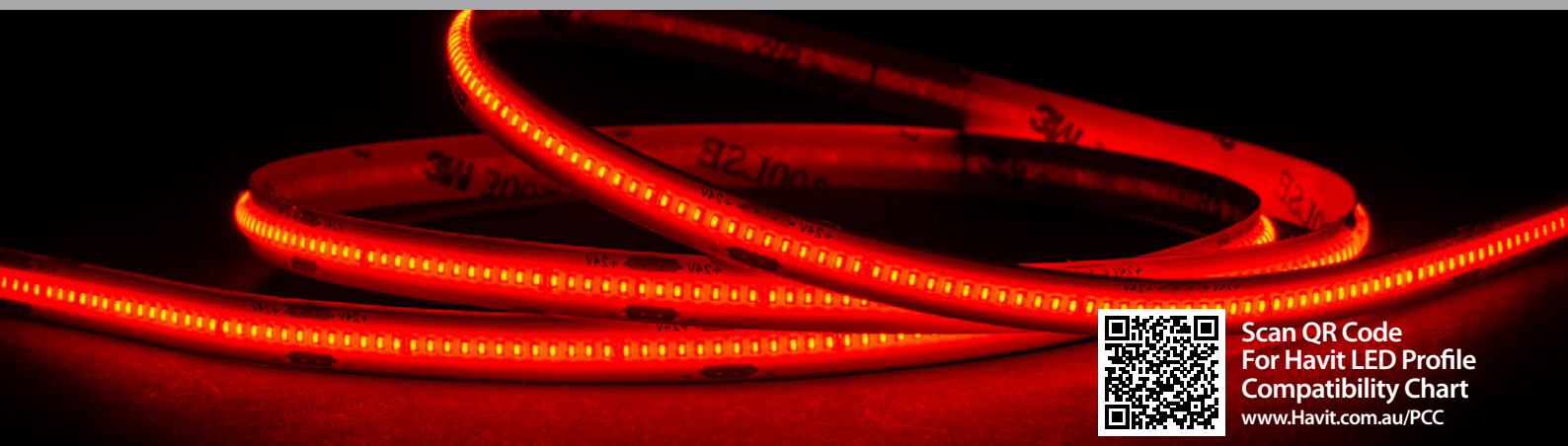

Scan QR Code
For Havit LED Profile
Compatibility Chart
www.Havit.com.au/PCC

Coloured LED Strip Lighting

- LED flexible strip light
- Red, Green and Blue
- Dimmable using Havit LED controllers
- Peel and stick backing for initial placement
- Beam angle 120 degrees

COLOURED COB - IP20 INDOOR - 30M REEL

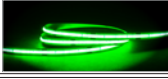
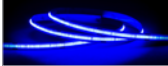
IMAGE	PART NUMBER	CHIP TYPE	IP RATING	LED PER METRE	LUMENS PER METRE	WATTAGE PER METRE	VOLTAGE	MAX LENGTH	CUTTING INCREMENT	SIZE WxH (MM)
	HV9761-IP20-320-R-30M	COB	IP20	320	140lm	9.6w/m	24v DC	5M	50mm	8x2
	HV9761-IP20-320-G-30M	COB	IP20	320	250lm	9.6w/m	24v DC	5M	50mm	8x2
	HV9761-IP20-320-B-30M	COB	IP20	320	60lm	9.6w/m	24v DC	5M	50mm	8x2

COLOURED COB - IP54 WATER RESISTANT - 10M REEL

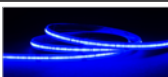
IMAGE	PART NUMBER	CHIP TYPE	IP RATING	LED PER METRE	LUMENS PER METRE	WATTAGE PER METRE	VOLTAGE	MAX LENGTH	CUTTING INCREMENT	SIZE WxH (MM)
	HV9761-IP54-320-B-10M	COB	IP20	320	60lm	9.6w/m	24v DC	5M	50mm	8x3

COLOURED COB - IP67 WEATHERPROOF - 10M REEL

IMAGE	PART NUMBER	CHIP TYPE	IP RATING	LED PER METRE	LUMENS PER METRE	WATTAGE PER METRE	VOLTAGE	MAX LENGTH	CUTTING INCREMENT	SIZE WxH (MM)
	HV9761-IP67-320-B-10M	COB	IP20	320	60lm	9.6w/m	24v DC	5M	50mm	12x6

HAVIT COMPATIBLE ACCESSORIES



See pages 295-306 for compatible drivers.
All low voltage products that specify an input of 12v or 24v DC must be used with a suitable LED driver.

ALL LED STRIP MUST BE INSTALLED ON AN ALUMINIUM HEAT DISSIPATING SURFACE

	HV9705-1003	10mm x 3mm Aluminum Heat Sink per metre (Max: 3 metre length)
---	-------------	---



For detailed product specifications
visit www.Havit.com.au
or scan this QR code





COB LED Strip Lighting

- LED flexible strip light
- Dimmable
- Peel and stick backing for initial placement
- Beam angle 120 degrees



Scan QR Code
For Havit LED Profile
Compatibility Chart
www.Havit.com.au/PCC



3000K FREE CUT COB - IP20 INDOOR - CUSTOM CUT TO LENGTH

IMAGE	PART NUMBER	CHIP TYPE	IP RATING	LED PER METRE	LUMENS PER METRE	WATTAGE PER METRE	VOLTAGE	MAX LENGTH	CUTTING INCREMENT	SIZE WxH (mm)
	HV9761-IP20-528-3K	COB	IP20	528	1200lm	12w/m	24v DC	5M	FREE CUT	8x2

4000K FREE CUT COB - IP20 INDOOR - CUSTOM CUT TO LENGTH

IMAGE	PART NUMBER	CHIP TYPE	IP RATING	LED PER METRE	LUMENS PER METRE	WATTAGE PER METRE	VOLTAGE	MAX LENGTH	CUTTING INCREMENT	SIZE WxH (mm)
	HV9761-IP20-528-4K	COB	IP20	528	1250lm	12w/m	24v DC	5M	FREE CUT	8x2

5500K FREE CUT COB - IP20 INDOOR - CUSTOM CUT TO LENGTH

IMAGE	PART NUMBER	CHIP TYPE	IP RATING	LED PER METRE	LUMENS PER METRE	WATTAGE PER METRE	VOLTAGE	MAX LENGTH	CUTTING INCREMENT	SIZE WxH (mm)
	HV9761-IP20-528-5K	COB	IP20	528	1300lm	12w/m	24v DC	5M	FREE CUT	8x2

3000K FREE CUT COB - IP20 INDOOR - 30M REEL

IMAGE	PART NUMBER	CHIP TYPE	IP RATING	LED PER METRE	LUMENS PER METRE	WATTAGE PER METRE	VOLTAGE	MAX LENGTH	CUTTING INCREMENT	SIZE WxH (mm)
	HV9761-IP20-528-3K-30M	COB	IP20	528	1200lm	12w/m	24v DC	5M	FREE CUT	8x2

4000K FREE CUT COB - IP20 INDOOR - 30M REEL

IMAGE	PART NUMBER	CHIP TYPE	IP RATING	LED PER METRE	LUMENS PER METRE	WATTAGE PER METRE	VOLTAGE	MAX LENGTH	CUTTING INCREMENT	SIZE WxH (mm)
	HV9761-IP20-528-4K-30M	COB	IP20	528	1250lm	12w/m	24v DC	5M	FREE CUT	8x2

5500K FREE CUT COB - IP20 INDOOR - 30M REEL

IMAGE	PART NUMBER	CHIP TYPE	IP RATING	LED PER METRE	LUMENS PER METRE	WATTAGE PER METRE	VOLTAGE	MAX LENGTH	CUTTING INCREMENT	SIZE WxH (mm)
	HV9761-IP20-528-5K-30M	COB	IP20	528	1300lm	12w/m	24v DC	5M	FREE CUT	8x2

HAVIT COMPATIBLE ACCESSORIES



See pages 295-306 for compatible drivers.
All low voltage products that specify an input of 12v or 24v DC must be used with a suitable LED driver.

ALL LED STRIP MUST BE INSTALLED ON AN ALUMINIUM HEAT DISSIPATING SURFACE



HV9705-1003 10mm x 3mm Aluminum Heat Sink per metre (Max: 3 metre length)

CUSTOM CUT ORDERS AVAILABLE

All custom cut orders require minimum of 48hrs production time from order confirmation, plus delivery time.



For detailed product specifications
visit www.Havit.com.au
or scan this QR code



Scan QR Code
For Havit LED Profile
Compatibility Chart
www.Havit.com.au/PCC

HaviFLEX™ Flexible Neon LED Strip 20 Metre Rolls

- HaviFLEX™ Neon Flexible LED Strip
- Dimmable
- Side bend
- Beam angle 120 degrees
- Supplied with 4x mounting clips per metre



3000K - IP67 WEATHERPROOF - 20 METRE ROLL									
IMAGE	PART NUMBER	SMD	LED PER METRE	LUMENS PER METRE	VOLTAGE	WATTAGE PER METRE	MAX LENGTH	CUTTING INCREMENT	SIZE WxH (mm)
	HV9791-IP67-140-3K-20M	2835	140	400lm	24v DC	9.6w/m	5m	50mm	4x8
4000K - IP67 WEATHERPROOF - 20 METRE ROLL									
IMAGE	PART NUMBER	SMD	LED PER METRE	LUMENS PER METRE	VOLTAGE	WATTAGE PER METRE	MAX LENGTH	CUTTING INCREMENT	SIZE WxH (mm)
	HV9791-IP67-140-4K-20M	2835	140	405lm	24v DC	9.6w/m	5m	50mm	4x8
5500K - IP67 WEATHERPROOF - 20 METRE ROLL									
IMAGE	PART NUMBER	SMD	LED PER METRE	LUMENS PER METRE	VOLTAGE	WATTAGE PER METRE	MAX LENGTH	CUTTING INCREMENT	SIZE WxH (mm)
	HV9791-IP67-140-5K-20M	2835	140	410lm	24v DC	9.6w/m	5m	50mm	4x8
HAVIT COMPATIBLE ACCESSORIES									
	See pages 295-306 for compatible drivers. All low voltage products that specify an input of 12v or 24v DC must be used with a suitable LED driver.								
	HV9791-MC	Mounting clip to suit HaviFLEX™ Flexible LED Strip							
	HV9791-ALU	Optional Aluminium Channel to suit HV9791 - Custom cut length up to 3m							
	HV9791-PVC-CHANNEL	White PC Channel to suit HV9791 - Supplied in 1m lengths only							
	HV9791-PVC-CHANNEL-2M	White PC Channel to suit HV9791 - Supplied as 2m Lengths only							





Scan QR Code
For Havit LED Profile
Compatibility Chart
www.Havit.com.au/PCC

HaviFLEX™ Flexible Neon LED Strip

- HaviFLEX™ Neon Flexible LED Strip
- Dimmable
- Side bend
- Beam angle 120 degrees
- Supplied with 4x mounting clips per metre



3000K - IP67 WEATHERPROOF - CUSTOM CUT TO LENGTH

IMAGE	PART NUMBER	SMD	LED PER METRE	LUMENS PER METRE	VOLTAGE	WATTAGE PER METRE	MAX LENGTH	CUTTING INCREMENT	SIZE WxH (mm)
	HV9791-IP67-140-3K	2835	140	400lm	24v DC	9.6w/m	5m	50mm	4x8

4000K - IP67 WEATHERPROOF - CUSTOM CUT TO LENGTH

IMAGE	PART NUMBER	SMD	LED PER METRE	LUMENS PER METRE	VOLTAGE	WATTAGE PER METRE	MAX LENGTH	CUTTING INCREMENT	SIZE WxH (mm)
	HV9791-IP67-140-4K	2835	140	405lm	24v DC	9.6w/m	5m	50mm	4x8

5500K - IP67 WEATHERPROOF - CUSTOM CUT TO LENGTH

IMAGE	PART NUMBER	SMD	LED PER METRE	LUMENS PER METRE	VOLTAGE	WATTAGE PER METRE	MAX LENGTH	CUTTING INCREMENT	SIZE WxH (mm)
	HV9791-IP67-140-5K	2835	140	410lm	24v DC	9.6w/m	5m	50mm	4x8

HAVIT COMPATIBLE ACCESSORIES

	See pages 295-306 for compatible drivers. All low voltage products that specify an input of 12v or 24v DC must be used with a suitable LED driver.								
	HV9791-MC	Mounting clip to suit HaviFLEX™ Flexible LED Strip							
	HV9791-ALU	Optional Aluminium Channel to suit HV9791 - Custom cut length up to 3m							
	HV9791-PVC-CHANNEL	White PC Channel to suit HV9791 - Supplied in 1m lengths only							
	HV9791-PVC-CHANNEL-2M	White PC Channel to suit HV9791 - Supplied as 2m Lengths only							

CUSTOM CUT ORDERS AVAILABLE

All custom cut orders require minimum of 48hrs production time from order confirmation, plus delivery time.



For detailed product specifications
visit www.Havit.com.au
or scan this QR code

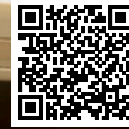

Scan QR Code
For Havit LED Profile
Compatibility Chart
www.Havit.com.au/PCC

HaviFLEX™ Flexible Neon LED Strip 20 Metre Rolls

- HaviFLEX™ Neon Flexible LED Strip
- Dimmable
- Side bend
- Beam angle 120 degrees
- Supplied with 4x mounting clips per metre



3000K - IP67 WEATHERPROOF - 20 METRE ROLL

IMAGE	PART NUMBER	SMD	LED PER METRE	LUMENS PER METRE	VOLTAGE	WATTAGE PER METRE	MAX LENGTH	CUTTING INCREMENT	SIZE WxH (mm)
	HV9792-IP67-140-3K-20M	2835	140	600lm	24v DC	14.4w/m	5m	50mm	6x11

4000K - IP67 WEATHERPROOF - 20 METRE ROLL

IMAGE	PART NUMBER	SMD	LED PER METRE	LUMENS PER METRE	VOLTAGE	WATTAGE PER METRE	MAX LENGTH	CUTTING INCREMENT	SIZE WxH (mm)
	HV9792-IP67-140-4K-20M	2835	140	630lm	24v DC	14.4w/m	5m	50mm	6x11







5500K - IP67 WEATHERPROOF - 20 METRE ROLL

IMAGE	PART NUMBER	SMD	LED PER METRE	LUMENS PER METRE	VOLTAGE	WATTAGE PER METRE	MAX LENGTH	CUTTING INCREMENT	SIZE WxH (mm)
	HV9792-IP67-140-5K-20M	2835	140	660lm	24v DC	14.4w/m	5m	50mm	6x11

RGB - IP67 WEATHERPROOF - 20 METRE ROLL

IMAGE	PART NUMBER	SMD	LED PER METRE	LUMENS PER METRE	VOLTAGE	WATTAGE PER METRE	MAX LENGTH	CUTTING INCREMENT	SIZE WxH (mm)
	HV9792-IP67-336-RGB-20M	2216	336	600lm	24v DC	14.4w/m	5m	63mm	6x11

HAVIT COMPATIBLE ACCESSORIES

	See pages 295-306 for compatible drivers. All low voltage products that specify an input of 12v or 24v DC must be used with a suitable LED driver.								
	RGB Models can be used with any RGB Controller in LED Controller section of this catalogue.								
	HV9792-MC	Mounting clip to suit HaviFLEX™ Flexible LED Strip							
	HV9792-ALU	Optional Aluminium Channel to suit HV9792 - Custom cut length up to 3m							
	HV9792-PVC-CHANNEL	White PC Channel to suit HV9792 - Supplied in 1m lengths only							
	HV9792-PVC-CHANNEL-2M	White PC Channel to suit HV9792 - Supplied as 2m Lengths only							





Scan QR Code
For Havit LED Profile
Compatibility Chart
www.Havit.com.au/PCC

HaviFLEX™ Flexible Neon LED Strip

- HaviFLEX™ Neon Flexible LED Strip
- Dimmable
- Side bend
- Beam angle 120 degrees
- Supplied with 4x mounting clips per metre



3000K - IP67 WEATHERPROOF - CUSTOM CUT TO LENGTH

IMAGE	PART NUMBER	SMD	LED PER METRE	LUMENS PER METRE	VOLTAGE	WATTAGE PER METRE	MAX LENGTH	CUTTING INCREMENT	SIZE WxH (mm)
	HV9792-IP67-140-3K	2835	140	600lm	24v DC	14.4w/m	5m	50mm	6x11

4000K - IP67 WEATHERPROOF - CUSTOM CUT TO LENGTH

IMAGE	PART NUMBER	SMD	LED PER METRE	LUMENS PER METRE	VOLTAGE	WATTAGE PER METRE	MAX LENGTH	CUTTING INCREMENT	SIZE WxH (mm)
	HV9792-IP67-140-4K	2835	140	630lm	24v DC	14.4w/m	5m	50mm	6x11

5500K - IP67 WEATHERPROOF - CUSTOM CUT TO LENGTH

IMAGE	PART NUMBER	SMD	LED PER METRE	LUMENS PER METRE	VOLTAGE	WATTAGE PER METRE	MAX LENGTH	CUTTING INCREMENT	SIZE WxH (mm)
	HV9792-IP67-140-5K	2835	140	660lm	24v DC	14.4w/m	5m	50mm	6x11

RGB - IP67 WEATHERPROOF - CUSTOM CUT TO LENGTH

IMAGE	PART NUMBER	SMD	LED PER METRE	LUMENS PER METRE	VOLTAGE	WATTAGE PER METRE	MAX LENGTH	CUTTING INCREMENT	SIZE WxH (mm)
	HV9792-IP67-336-RGB	2216	336	600lm	24v DC	14.4w/m	5m	63mm	6x11

HAVIT COMPATIBLE ACCESSORIES

	See pages 295-306 for compatible drivers. All low voltage products that specify an input of 12v or 24v DC must be used with a suitable LED driver.								
	RGB Models can be used with any RGB Controller in LED Controller section of this catalogue.								
	HV9792-MC	Mounting clip to suit HaviFLEX™ Flexible LED Strip							
	HV9792-ALU	Optional Aluminium Channel to suit HV9792 - Custom cut length up to 3m							
	HV9792-PVC-CHANNEL	White PC Channel to suit HV9792 - Supplied in 1m lengths only							
	HV9792-PVC-CHANNEL-2M	White PC Channel to suit HV9792 - Supplied as 2m Lengths only							

CUSTOM CUT ORDERS AVAILABLE

All custom cut orders require minimum of 48hrs production time from order confirmation, plus delivery time.



For detailed product specifications
visit www.Havit.com.au
or scan this QR code



Scan QR Code
For Havit LED Profile
Compatibility Chart
www.Havit.com.au/PCC

HaviFLEX™ Flexible Neon LED Strip 20 Metre Rolls

- HaviFLEX™ Neon Flexible LED Strip
- Dimmable
- Side bend
- Beam angle 120 degrees
- Supplied with 4x mounting clips per metre



3000K - IP67 WEATHERPROOF - 20 METRE ROLL

IMAGE	PART NUMBER	SMD	LED PER METRE	LUMENS PER METRE	VOLTAGE	WATTAGE PER METRE	MAX LENGTH	CUTTING INCREMENT	SIZE WxH (mm)
	HV9795-IP67-200-3K-20M	2835	120	600lm	24v DC	14.4w/m	5m	50mm	12x17

4000K - IP67 WEATHERPROOF - 20 METRE ROLL

IMAGE	PART NUMBER	SMD	LED PER METRE	LUMENS PER METRE	VOLTAGE	WATTAGE PER METRE	MAX LENGTH	CUTTING INCREMENT	SIZE WxH (mm)
	HV9795-IP67-200-4K-20M	2835	120	620lm	24v DC	14.4w/m	5m	50mm	12x17

5500K - IP67 WEATHERPROOF - 20 METRE ROLL

IMAGE	PART NUMBER	SMD	LED PER METRE	LUMENS PER METRE	VOLTAGE	WATTAGE PER METRE	MAX LENGTH	CUTTING INCREMENT	SIZE WxH (mm)
	HV9795-IP67-200-5K-20M	2835	120	650lm	24v DC	14.4w/m	5m	50mm	12x17

RGBW - IP67 WEATHERPROOF - 20 METRE ROLL

IMAGE	PART NUMBER	SMD	LED PER METRE	LUMENS PER METRE	VOLTAGE	WATTAGE PER METRE	MAX LENGTH	CUTTING INCREMENT	SIZE WxH (mm)
	HV9795-IP67-200-RGBW-20M	2835	192	450lm	24v DC	14.4w/m	5m	62.5mm	12x17

CHASING RGB - IP67 WEATHERPROOF - 20 METRE ROLL

IMAGE	PART NUMBER	SMD	LED PER METRE	LUMENS PER METRE	VOLTAGE	WATTAGE PER METRE	MAX LENGTH	CUTTING INCREMENT	SIZE WxH (mm)
	HV9795-IP67-200-SPIRGB-20M	2835	84	405lm	24v DC	20w	5m	83.3mm	12x17

HAVIT COMPATIBLE ACCESSORIES

	See pages 295-306 for compatible drivers. All low voltage products that specify an input of 12v or 24v DC must be used with a suitable LED driver.								
	RGBW Models can be used with any RGBW Controller in LED Controller section of this catalogue.								
	HV9795-MC	Mounting clip to suit HaviFLEX™ Flexible LED Strip							
	HV9795-ALU	Optional Aluminium Channel to suit HV9795 - Supplied in 1m length only							
	HV9795-ALU-BEND	Optional Bendable Channel to suit HV9795 - Supplied in 2x 500mm lengths only							





Scan QR Code
For Havit LED Profile
Compatibility Chart
www.Havit.com.au/PCC

HaviFLEX™ Flexible Neon LED Strip

- HaviFLEX™ Neon Flexible LED Strip
- Dimmable
- Side bend
- Beam angle 120 degrees
- Supplied with 4x mounting clips per metre



3000K - IP67 WEATHERPROOF - CUSTOM CUT TO LENGTH

IMAGE	PART NUMBER	SMD	LED PER METRE	LUMENS PER METRE	VOLTAGE	WATTAGE PER METRE	MAX LENGTH	CUTTING INCREMENT	SIZE WxH (mm)
	HV9795-IP67-200-3K	2835	120	600lm	24v DC	14.4w/m	5m	50mm	12x17

4000K - IP67 WEATHERPROOF - CUSTOM CUT TO LENGTH

IMAGE	PART NUMBER	SMD	LED PER METRE	LUMENS PER METRE	VOLTAGE	WATTAGE PER METRE	MAX LENGTH	CUTTING INCREMENT	SIZE WxH (mm)
	HV9795-IP67-200-4K	2835	120	620lm	24v DC	14.4w/m	5m	50mm	12x17

5500K - IP67 WEATHERPROOF - CUSTOM CUT TO LENGTH

IMAGE	PART NUMBER	SMD	LED PER METRE	LUMENS PER METRE	VOLTAGE	WATTAGE PER METRE	MAX LENGTH	CUTTING INCREMENT	SIZE WxH (mm)
	HV9795-IP67-200-5K	2835	120	650lm	24v DC	14.4w/m	5m	50mm	12x17





RGBW - IP67 WEATHERPROOF - CUSTOM CUT TO LENGTH

IMAGE	PART NUMBER	SMD	LED PER METRE	LUMENS PER METRE	VOLTAGE	WATTAGE PER METRE	MAX LENGTH	CUTTING INCREMENT	SIZE WxH (mm)
	HV9795-IP67-200-RGBW	2835	192	450lm	24v DC	14.4w/m	5m	62.5mm	12x17

CHASING RGB - IP67 WEATHERPROOF - CUSTOM CUT TO LENGTH

IMAGE	PART NUMBER	SMD	LED PER METRE	LUMENS PER METRE	VOLTAGE	WATTAGE PER METRE	MAX LENGTH	CUTTING INCREMENT	SIZE WxH (mm)
	HV9795-IP67-200-SPIRGB	2835	84	405lm	24v DC	20w	5m	83.3mm	12x17

HAVIT COMPATIBLE ACCESSORIES

	See pages 295-306 for compatible drivers. All low voltage products that specify an input of 12v or 24v DC must be used with a suitable LED driver.								
	RGBW Models can be used with any RGBW Controller in LED Controller section of this catalogue.								
	HV9795-MC	Mounting clip to suit HaviFLEX™ Flexible LED Strip							
	HV9795-ALU	Optional Aluminium Channel to suit HV9795 - Supplied in 1m length only							
	HV9795-ALU-BEND	Optional Bendable Channel to suit HV9795 - Supplied in 2x 500mm lengths only							



For detailed product specifications
visit www.Havit.com.au
or scan this QR code

HaviFLEX™ Flexible Neon LED Strip 20 Metre Rolls

- HaviFLEX™ Neon Flexible LED Strip
- Dimmable
- Top bend
- Beam angle 120 degrees
- Supplied with 4x mounting clips per metre



3000K - IP67 WEATHERPROOF - 20 METRE ROLL

IMAGE	PART NUMBER	SMD	LED PER METRE	LUMENS PER METRE	VOLTAGE	WATTAGE PER METRE	MAX LENGTH	CUTTING INCREMENT	SIZE WxH (mm)
	HV9796-IP67-200-3K-20M	2835	120	600lm	24v DC	14.4w/m	5m	50mm	15x15

4000K - IP67 WEATHERPROOF - 20 METRE ROLL

IMAGE	PART NUMBER	SMD	LED PER METRE	LUMENS PER METRE	VOLTAGE	WATTAGE PER METRE	MAX LENGTH	CUTTING INCREMENT	SIZE WxH (mm)
	HV9796-IP67-200-4K-20M	2835	120	620lm	24v DC	14.4w/m	5m	50mm	15x15

5500K - IP67 WEATHERPROOF - 20 METRE ROLL

IMAGE	PART NUMBER	SMD	LED PER METRE	LUMENS PER METRE	VOLTAGE	WATTAGE PER METRE	MAX LENGTH	CUTTING INCREMENT	SIZE WxH (mm)
	HV9796-IP67-200-5K-20M	2835	120	650lm	24v DC	14.4w/m	5m	50mm	15x15

RGBW - IP67 WEATHERPROOF - 20 METRE ROLL

IMAGE	PART NUMBER	SMD	LED PER METRE	LUMENS PER METRE	VOLTAGE	WATTAGE PER METRE	MAX LENGTH	CUTTING INCREMENT	SIZE WxH (mm)
	HV9796-IP67-200-RGBW-20M	2835	192	450lm	24v DC	14.4w/m	5m	62.5mm	15x15

HAVIT COMPATIBLE ACCESSORIES

	See pages 295-306 for compatible drivers. All low voltage products that specify an input of 12v or 24v DC must be used with a suitable LED driver.								
	RGBW Models can be used with any RGBW Controller in LED Controller section of this catalogue.								
	HV9796-MC	Mounting clip to suit HaviFLEX™ Flexible LED Strip							
	HV9796-ALU	Optional Aluminium Channel to suit HV9796 - Supplied in 1m length only							
	HV9796-ALU-BEND	Optional Bendable Channel to suit HV9796 - Supplied in 2x 500mm lengths only							



HaviFLEX™ Flexible Neon LED Strip

- HaviFLEX™ Neon Flexible LED Strip
- Dimmable
- Top bend
- Beam angle 120 degrees
- Supplied with 4x mounting clips per metre



3000K - IP67 WEATHERPROOF - CUSTOM CUT TO LENGTH

IMAGE	PART NUMBER	SMD	LED PER METRE	LUMENS PER METRE	VOLTAGE	WATTAGE PER METRE	MAX LENGTH	CUTTING INCREMENT	SIZE WxH (mm)
	HV9796-IP67-200-3K	2835	120	600lm	24v DC	14.4w/m	5m	50mm	15x15

4000K - IP67 WEATHERPROOF - CUSTOM CUT TO LENGTH

IMAGE	PART NUMBER	SMD	LED PER METRE	LUMENS PER METRE	VOLTAGE	WATTAGE PER METRE	MAX LENGTH	CUTTING INCREMENT	SIZE WxH (mm)
	HV9796-IP67-200-4K	2835	120	620lm	24v DC	14.4w/m	5m	50mm	15x15

5500K - IP67 WEATHERPROOF - CUSTOM CUT TO LENGTH

IMAGE	PART NUMBER	SMD	LED PER METRE	LUMENS PER METRE	VOLTAGE	WATTAGE PER METRE	MAX LENGTH	CUTTING INCREMENT	SIZE WxH (mm)
	HV9796-IP67-200-5K	2835	120	650lm	24v DC	14.4w/m	5m	50mm	15x15

RGBW - IP67 WEATHERPROOF - CUSTOM CUT TO LENGTH

IMAGE	PART NUMBER	SMD	LED PER METRE	LUMENS PER METRE	VOLTAGE	WATTAGE PER METRE	MAX LENGTH	CUTTING INCREMENT	SIZE WxH (mm)
	HV9796-IP67-200-RGBW	2835	192	450lm	24v DC	14.4w/m	5m	62.5mm	15x15

HAVIT COMPATIBLE ACCESSORIES

	See pages 295-306 for compatible drivers. All low voltage products that specify an input of 12v or 24v DC must be used with a suitable LED driver.								
	RGBW Models can be used with any RGBW Controller in LED Controller section of this catalogue.								
	HV9796-MC	Mounting clip to suit HaviFLEX™ Flexible LED Strip							
	HV9796-ALU	Optional Aluminium Channel to suit HV9796 - Supplied in 1m length only							
	HV9796-ALU-BEND	Optional Bendable Channel to suit HV9796 - Supplied in 2x 500mm lengths only							

CUSTOM CUT ORDERS AVAILABLE

All custom cut orders require minimum of 48hrs production time from order confirmation, plus delivery time.



For detailed product specifications
visit www.Havit.com.au
or scan this QR code



Scan QR Code
For Havit LED Profile
Compatibility Chart
www.Havit.com.au/PCC



Side Mounted LED Strip Lighting 20 Metre Rolls

- LED flexible strip light
- Dimmable using Havit LED controllers
- Peel and stick backing for initial placement
- Beam angle 120 degrees

3000K - IP20 SIDE MOUNTED - 20 METRE ROLL

IMAGE	PART NUMBER	SMD	LED PER METRE	LUMENS PER METRE	VOLTAGE	WATTAGE PER METRE	MAX LENGTH	CUTTING INCREMENT	SIZE WxH (mm)
	HV9723-IP20-96SM-3K-20M	335	96	500lm	12v DC	7.7w/m	5m	33mm	6x2mm

4000K - IP20 SIDE MOUNTED - 20 METRE ROLL

IMAGE	PART NUMBER	SMD	LED PER METRE	LUMENS PER METRE	VOLTAGE	WATTAGE PER METRE	MAX LENGTH	CUTTING INCREMENT	SIZE WxH (mm)
	HV9723-IP20-96SM-4K-20M	335	96	520lm	12v DC	7.7w/m	5m	33mm	6x2

5500K - IP20 SIDE MOUNTED - 20 METRE ROLL

IMAGE	PART NUMBER	SMD	LED PER METRE	LUMENS PER METRE	VOLTAGE	WATTAGE PER METRE	MAX LENGTH	CUTTING INCREMENT	SIZE WxH (mm)
	HV9723-IP20-96SM-5K-20M	335	96	540lm	12v DC	7.7w/m	5m	33mm	6x2

COLOURED - IP20 INDOOR - 20 METRE ROLL

IMAGE	PART NUMBER	SMD	LED PER METRE	LUMENS PER METRE	VOLTAGE	WATTAGE PER METRE	MAX LENGTH	CUTTING INCREMENT	SIZE WxH (mm)
	HV9723-IP20-96SM-R-20M	335	Red	179lm	12v DC	7.7w/m	5m	33mm	6x2
	HV9723-IP20-96SM-G-20M	335	Green	350lm	12v DC	7.7w/m	5m	33mm	6x2
	HV9723-IP20-96SM-B-20M	335	Blue	92lm	12v DC	7.7w/m	5m	33mm	6x2

HAVIT COMPATIBLE ACCESSORIES

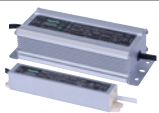

See pages 295-306 for compatible drivers.
All low voltage products that specify an input of 12v or 24v DC must be used with a suitable LED driver.

ALL LED STRIP MUST BE INSTALLED ON AN ALUMINIUM HEAT DISSIPATING SURFACE

	HV9705-1003	10mm x 3mm Aluminum Heat Sink per metre (Max: 3 metre length)							
--	--------------------	---	--	--	--	--	--	--	--





Scan QR Code
For Havit LED Profile
Compatibility Chart
www.Havit.com.au/PCC

Side Mounted LED Strip Lighting

- LED flexible strip light
- Dimmable using Havit LED controllers
- Peel and stick backing for initial placement
- Beam angle 120 degrees



3000K - IP20 SIDE MOUNTED - CUSTOM CUT TO LENGTH

IMAGE	PART NUMBER	SMD	LED PER METRE	LUMENS PER METRE	VOLTAGE	WATTAGE PER METRE	MAX LENGTH	CUTTING INCREMENT	SIZE WxH (mm)
	HV9723-IP20-96SM-3K	335	96	500lm	12v DC	7.7w/m	5m	33mm	6x2mm

4000K - IP20 SIDE MOUNTED - CUSTOM CUT TO LENGTH

IMAGE	PART NUMBER	SMD	LED PER METRE	LUMENS PER METRE	VOLTAGE	WATTAGE PER METRE	MAX LENGTH	CUTTING INCREMENT	SIZE WxH (mm)
	HV9723-IP20-96SM-4K	335	96	520lm	12v DC	7.7w/m	5m	33mm	6x2

5500K - IP20 SIDE MOUNTED - CUSTOM CUT TO LENGTH

IMAGE	PART NUMBER	SMD	LED PER METRE	LUMENS PER METRE	VOLTAGE	WATTAGE PER METRE	MAX LENGTH	CUTTING INCREMENT	SIZE WxH (mm)
	HV9723-IP20-96SM-5K	335	96	540lm	12v DC	7.7w/m	5m	33mm	6x2

COLOURED - IP20 INDOOR - CUSTOM CUT TO LENGTH

IMAGE	PART NUMBER	SMD	LED PER METRE	LUMENS PER METRE	VOLTAGE	WATTAGE PER METRE	MAX LENGTH	CUTTING INCREMENT	SIZE WxH (mm)
	HV9723-IP20-96SM-R	335	Red	179lm	12v DC	7.7w/m	5m	33mm	6x2
	HV9723-IP20-96SM-G	335	Green	350lm	12v DC	7.7w/m	5m	33mm	6x2
	HV9723-IP20-96SM-B	335	Blue	92lm	12v DC	7.7w/m	5m	33mm	6x2

HAVIT COMPATIBLE ACCESSORIES



See pages 295-306 for compatible drivers.
All low voltage products that specify an input of 12v or 24v DC must be used with a suitable LED driver.

ALL LED STRIP MUST BE INSTALLED ON AN ALUMINIUM HEAT DISSIPATING SURFACE



HV9705-1003

10mm x 3mm Aluminum Heat Sink per metre (Max: 3 metre length)

CUSTOM CUT ORDERS AVAILABLE

All custom cut orders require minimum of 48hrs production time from order confirmation, plus delivery time.



For detailed product specifications
visit www.Havit.com.au
or scan this QR code



CT LED Strip Lighting

- LED flexible strip light
- 3000K + 5500K together on one strip
- Must be used with CT Controllers
- Peel and stick backing for initial placement
- Beam angle 120 degrees



Scan QR Code
For Havit LED Profile
Compatibility Chart
www.Havit.com.au/PCC



CT COB - IP20 INDOOR

IMAGE	PART NUMBER	CHIP TYPE	IP RATING	LED PER METRE	LUMENS PER METRE	WATTAGE PER METRE	VOLTAGE	MAX LENGTH	CUTTING INCREMENT	SIZE WxH (MM)
	HV9761-IP20-608-CT	COB	IP20	608	800lm	14.4w/m	24v DC	5M	50mm	10x2
	HV9761-IP20-608-CT-30M	COB	IP20	608	800lm	14.4w/m	24v DC	5M	50mm	10x2

CT COB - IP54 WATER RESISTANT

IMAGE	PART NUMBER	CHIP TYPE	IP RATING	LED PER METRE	LUMENS PER METRE	WATTAGE PER METRE	VOLTAGE	MAX LENGTH	CUTTING INCREMENT	SIZE WxH (MM)
	HV9761-IP54-608-CT	COB	IP54	608	800lm	14.4w/m	24v DC	5M	50mm	10x3
	HV9761-IP54-608-CT-10M	COB	IP54	608	800lm	14.4w/m	24v DC	5M	50mm	10x3

CT COB - IP67 WEATHERPROOF

IMAGE	PART NUMBER	CHIP TYPE	IP RATING	LED PER METRE	LUMENS PER METRE	WATTAGE PER METRE	VOLTAGE	MAX LENGTH	CUTTING INCREMENT	SIZE WxH (MM)
	HV9761-IP67-608-CT	COB	IP67	608	800lm	14.4w/m	24v DC	5M	50mm	14x6
	HV9761-IP67-608-CT-10M	COB	IP67	608	800lm	14.4w/m	24v DC	5M	50mm	14x6

HAVIT COMPATIBLE ACCESSORIES



See pages 295-306 for compatible drivers.
All low voltage products that specify an input of 12v or 24v DC must be used with a suitable LED driver.



CT Models can be used with any CT Controller in LED Controller section of this catalogue.

ALL LED STRIP MUST BE INSTALLED ON AN ALUMINIUM HEAT DISSIPATING SURFACE



HV9705-1003

10mm x 3mm Aluminum Heat Sink per metre (Max: 3 metre length)

CUSTOM CUT ORDERS AVAILABLE

All custom cut orders require minimum of 48hrs production time from order confirmation, plus delivery time.



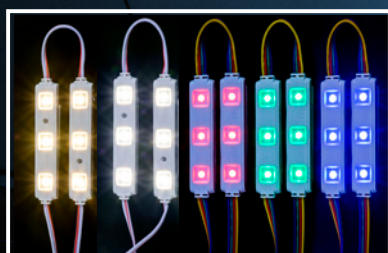

HAVIT Lighting



Signage Modules

IMAGE	PART NUMBER	SMD	IP RATING	COLOUR TEMP	LUMENS PER LENGTH	VOLTAGE	WATTAGE PER MODULE	INCLUDED NO. OF MODULES	SIZE LxWxH (mm)
	HV9794-IP65-10-3K	5050	IP65	3000K	650lm	12v DC	0.72w	10 Modules	84x16x6
	HV9794-IP65-10-4K	5050	IP65	4000K	660lm	12v DC	0.72w	10 Modules	84x16x6
	HV9794-IP65-10-5K	5050	IP65	5000K	670lm	12v DC	0.72w	10 Modules	84x16x6
	HV9794-IP65-10-RGB	5050	IP65	RGB	210lm	12v DC	0.72w	10 Modules	84x16x6
	HV9794-IP65-20-3K	5050	IP65	3000K	1300lm	12v DC	0.72w	20 Modules	84x16x6
	HV9794-IP65-20-4K	5050	IP65	4000K	1320lm	12v DC	0.72w	20 Modules	84x16x6
	HV9794-IP65-20-5K	5050	IP65	5000K	1340lm	12v DC	0.72w	20 Modules	84x16x6
	HV9794-IP65-20-RGB	5050	IP65	RGB	420lm	12v DC	0.72w	20 Modules	84x16x6

HAVIT COMPATIBLE ACCESSORIES



See pages 295-306 for compatible drivers.
All low voltage products that specify an input of 12v or 24v DC must be used with a suitable LED driver.



RGB Models can be used with any RGB Controller in LED Controller section of this catalogue.



For detailed product specifications
visit www.Havit.com.au
or scan this QR code



Scan QR Code
For Havit LED Profile
Compatibility Chart
www.Havit.com.au/PCC

Multi Colour RGB LED Strip Lighting Rolls

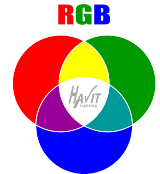

- LED flexible strip light
- Colours selected using Havit LED controllers
- Peel and stick backing for initial placement
- Beam angle 120 degrees

RGB COB - IP20 INDOOR - 30 METRE ROLL										
IMAGE	PART NUMBER	CHIP TYPE	IP RATING	LED PER METRE	LUMENS PER METRE	WATTAGE PER METRE	VOLTAGE	MAX LENGTH	CUTTING INCREMENT	SIZE WxH (MM)
	HV9761-IP20-480-RGB-30M	COB	IP20	480	500lm	15w/m	24v DC	5M	50mm	10x2
RGB COB - IP54 WATER RESISTANT - 10 METRE ROLL										
IMAGE	PART NUMBER	CHIP TYPE	IP RATING	LED PER METRE	LUMENS PER METRE	WATTAGE PER METRE	VOLTAGE	MAX LENGTH	CUTTING INCREMENT	SIZE WxH (MM)
	HV9761-IP54-480-RGB-10M	COB	IP54	480	500lm	15w/m	24v DC	5M	50mm	10x3
RGB COB - IP67 WEATHERPROOF - 10 METRE ROLL										
IMAGE	PART NUMBER	CHIP TYPE	IP RATING	LED PER METRE	LUMENS PER METRE	WATTAGE PER METRE	VOLTAGE	MAX LENGTH	CUTTING INCREMENT	SIZE WxH (MM)
	HV9761-IP67-480-RGB-10M	COB	IP67	480	500lm	15w/m	24v DC	5M	50mm	14x6
HAVIT COMPATIBLE ACCESSORIES										
	See pages 295-306 for compatible drivers. All low voltage products that specify an input of 12v or 24v DC must be used with a suitable LED driver.									
	RGB Models can be used with any RGB Controller in LED Controller section of this catalogue.									
ALL LED STRIP MUST BE INSTALLED ON AN ALUMINIUM HEAT DISSIPATING SURFACE										
	HV9705-1003	10mm x 3mm Aluminum Heat Sink per metre (Max: 3 metre length)								
	HV9705-1603	16mm x 3mm Aluminum Heat Sink per metre (Max: 3 metre length)								



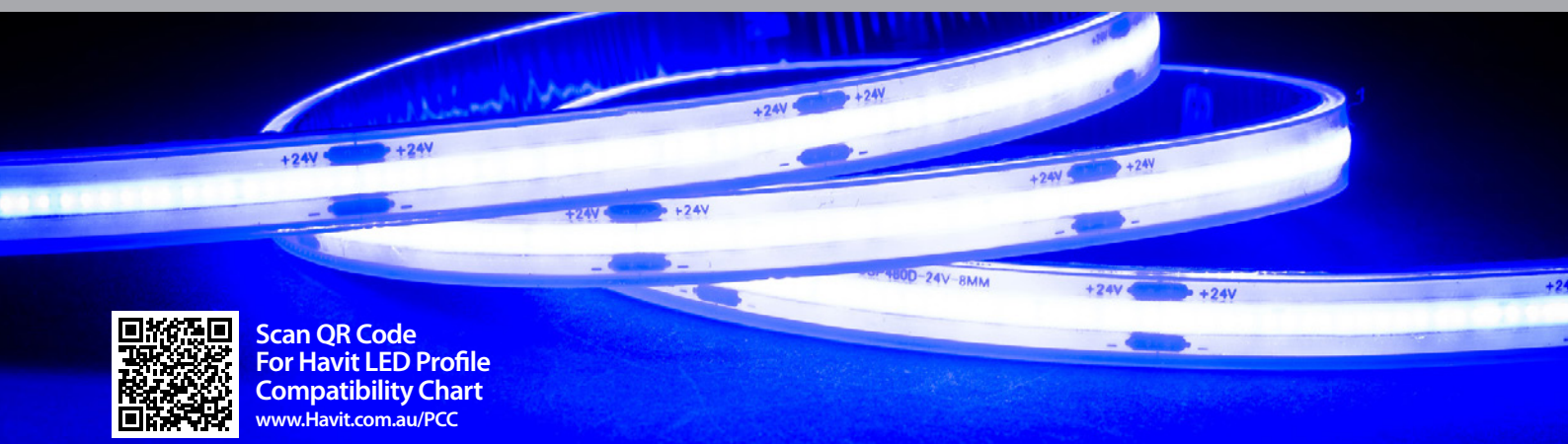

Scan QR Code
For Havit LED Profile
Compatibility Chart
www.Havit.com.au/PCC

Multi Colour RGB LED Strip Lighting

- LED flexible strip light
- Colours selected using Havit LED controllers
- Peel and stick backing for initial placement
- Beam angle 120 degrees

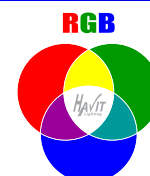

RGB COB - IP20 INDOOR - CUSTOM CUT TO LENGTH

IMAGE	PART NUMBER	CHIP TYPE	IP RATING	LED PER METRE	LUMENS PER METRE	WATTAGE PER METRE	VOLTAGE	MAX LENGTH	CUTTING INCREMENT	SIZE WxH (MM)
	HV9761-IP20-480-RGB	COB	IP20	480	500lm	15w/m	24v DC	5M	50mm	10x2

RGB COB - IP54 WATER RESISTANT - CUSTOM CUT TO LENGTH

IMAGE	PART NUMBER	CHIP TYPE	IP RATING	LED PER METRE	LUMENS PER METRE	WATTAGE PER METRE	VOLTAGE	MAX LENGTH	CUTTING INCREMENT	SIZE WxH (MM)
	HV9761-IP54-480-RGB	COB	IP54	480	500lm	15w/m	24v DC	5M	50mm	10x3

RGB COB - IP67 WEATHERPROOF - CUSTOM CUT TO LENGTH

IMAGE	PART NUMBER	CHIP TYPE	IP RATING	LED PER METRE	LUMENS PER METRE	WATTAGE PER METRE	VOLTAGE	MAX LENGTH	CUTTING INCREMENT	SIZE WxH (MM)
	HV9761-IP67-480-RGB	COB	IP67	480	500lm	15w/m	24v DC	5M	50mm	14x6

HAVIT COMPATIBLE ACCESSORIES

	See pages 295-306 for compatible drivers. All low voltage products that specify an input of 12v or 24v DC must be used with a suitable LED driver.
	RGB Models can be used with any RGB Controller in LED Controller section of this catalogue.

ALL LED STRIP MUST BE INSTALLED ON AN ALUMINIUM HEAT DISSIPATING SURFACE

	HV9705-1003	10mm x 3mm Aluminum Heat Sink per metre (Max: 3 metre length)
	HV9705-1603	16mm x 3mm Aluminum Heat Sink per metre (Max: 3 metre length)



For detailed product specifications
visit www.Havit.com.au
or scan this QR code



Scan QR Code
For Havit LED Profile
Compatibility Chart
www.Havit.com.au/PCC

Multi Colour RGBC & RGBW LED Strip Rolls

- LED flexible strip light
- Colours selected using Havit LED controllers
- Peel and stick backing for initial placement
- Beam angle 120 degrees

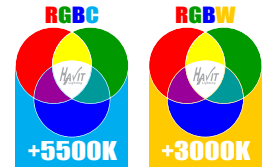

RGBC + RGBW COB - IP20 INDOOR - 30 METRE ROLL									
IMAGE	PART NUMBER	SMD	LED PER METRE	LUMENS PER METRE	VOLTAGE	WATTAGE PER METRE	MAX LENGTH	CUTTING INCREMENT	SIZE WxH (mm)
	HV9761-IP20-896-RGBC-30M	COB	896	500lm	20w/m	24v DC	5M	50mm	12x2
	HV9761-IP20-896-RGBW-30M	COB	896	500lm	20w/m	24v DC	5M	50mm	12x2
RGBC + RGBW COB - IP54 WATER RESISTANT - 10 METRE ROLL									
IMAGE	PART NUMBER	SMD	LED PER METRE	LUMENS PER METRE	VOLTAGE	WATTAGE PER METRE	MAX LENGTH	CUTTING INCREMENT	SIZE WxH (mm)
	HV9761-IP54-896-RGBC-10M	COB	896	500lm	20w/m	24v DC	5M	50mm	12x3
	HV9761-IP54-896-RGBW-10M	COB	896	500lm	20w/m	24v DC	5M	50mm	12x3
RGBC + RGBW COB - IP67 WEATHERPROOF - 10 METRE ROLL									
IMAGE	PART NUMBER	SMD	LED PER METRE	LUMENS PER METRE	VOLTAGE	WATTAGE PER METRE	MAX LENGTH	CUTTING INCREMENT	SIZE WxH (mm)
	HV9761-IP67-896-RGBC-10M	COB	896	500lm	20w/m	24v DC	5M	50mm	16x6
	HV9761-IP67-896-RGBW-10M	COB	896	500lm	20w/m	24v DC	5M	50mm	16x6
HAVIT COMPATIBLE ACCESSORIES									
	See pages 295-306 for compatible drivers. All low voltage products that specify an input of 12v or 24v DC must be used with a suitable LED driver.								
	RGBC & RGBW Models can be used with any RGBC & RGBW Controller in LED Controller section of this catalogue.								
ALL LED STRIP MUST BE INSTALLED ON AN ALUMINIUM HEAT DISSIPATING SURFACE									
	HV9705-1003	10mm x 3mm Aluminum Heat Sink per metre (Max: 3 metre length)							
	HV9705-1603	16mm x 3mm Aluminum Heat Sink per metre (Max: 3 metre length)							



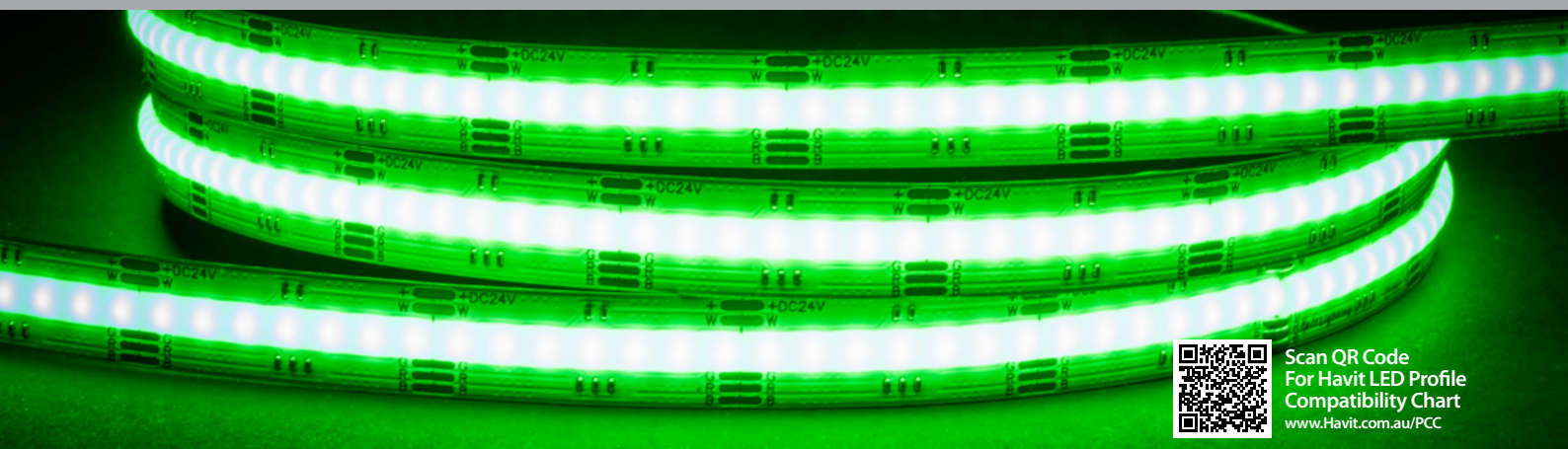

Scan QR Code
For Havit LED Profile
Compatibility Chart
www.Havit.com.au/PCC

Multi Colour RGBC & RGBW LED Strip Lighting

- LED flexible strip light
- Colours selected using Havit LED controllers
- Peel and stick backing for initial placement
- Beam angle 120 degrees

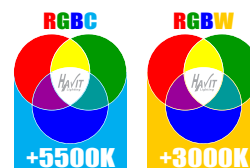

RGBC + RGBW COB - IP20 INDOOR - CUSTOM CUT TO LENGTH

IMAGE	PART NUMBER	SMD	LED PER METRE	LUMENS PER METRE	VOLTAGE	WATTAGE PER METRE	MAX LENGTH	CUTTING INCREMENT	SIZE WxH (mm)
	HV9761-IP20-896-RGBC	COB	896	500lm	20w/m	24v DC	5M	50mm	12x2
	HV9761-IP20-896-RGBW	COB	896	500lm	20w/m	24v DC	5M	50mm	12x2

RGBC + RGBW COB - IP54 WATER RESISTANT - CUSTOM CUT TO LENGTH

IMAGE	PART NUMBER	SMD	LED PER METRE	LUMENS PER METRE	VOLTAGE	WATTAGE PER METRE	MAX LENGTH	CUTTING INCREMENT	SIZE WxH (mm)
	HV9761-IP54-896-RGBC	COB	896	500lm	20w/m	24v DC	5M	50mm	12x3
	HV9761-IP54-896-RGBW	COB	896	500lm	20w/m	24v DC	5M	50mm	12x3

RGBC + RGBW COB - IP67 WEATHERPROOF - CUSTOM CUT TO LENGTH

IMAGE	PART NUMBER	SMD	LED PER METRE	LUMENS PER METRE	VOLTAGE	WATTAGE PER METRE	MAX LENGTH	CUTTING INCREMENT	SIZE WxH (mm)
	HV9761-IP67-896-RGBC	COB	896	500lm	20w/m	24v DC	5M	50mm	16x6
	HV9761-IP67-896-RGBW	COB	896	500lm	20w/m	24v DC	5M	50mm	16x6

HAVIT COMPATIBLE ACCESSORIES

	See pages 295-306 for compatible drivers. All low voltage products that specify an input of 12v or 24v DC must be used with a suitable LED driver.
	RGBC & RGBW Models can be used with any RGBC & RGBW Controller in LED Controller section of this catalogue.

ALL LED STRIP MUST BE INSTALLED ON AN ALUMINIUM HEAT DISSIPATING SURFACE

	HV9705-1003	10mm x 3mm Aluminum Heat Sink per metre (Max: 3 metre length)
	HV9705-1603	16mm x 3mm Aluminum Heat Sink per metre (Max: 3 metre length)

CUSTOM CUT ORDERS AVAILABLE

All custom cut orders require minimum of 48hrs production time from order confirmation, plus delivery time.



For detailed product specifications
visit www.Havit.com.au
or scan this QR code

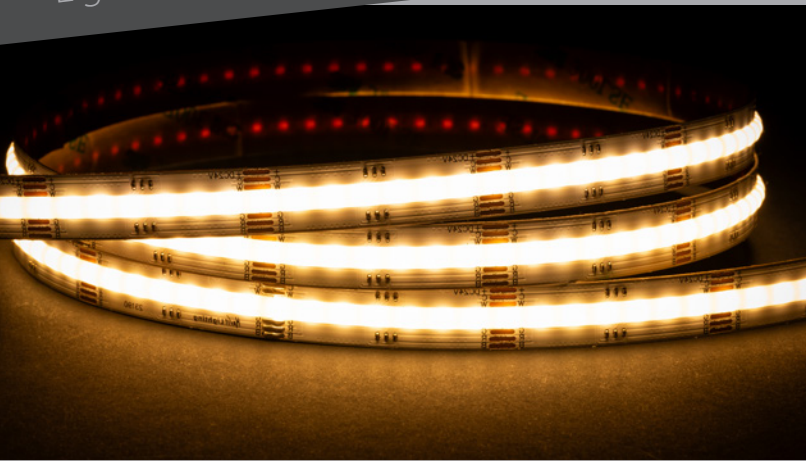

Scan QR Code
For Havit LED Profile
Compatibility Chart
www.Havit.com.au/PCC



Multi Colour RGBCW LED Strip Rolls

- LED flexible strip light
- Colours selected using Havit LED controllers
- Peel and stick backing for initial placement
- Beam angle 120 degrees

RGBCW COB - IP20 INDOOR - 30 METRE ROLL										
IMAGE	PART NUMBER	CHIP TYPE	IP RATING	LED PER METRE	LUMENS PER METRE	WATTAGE PER METRE	VOLTAGE	MAX LENGTH	CUTTING INCREMENT	SIZE WxH (MM)
	HV9761-IP20-840-RGBCW-30M	COB	IP20	840	500lm	20w/m	24v DC	5M	50mm	12x2
RGBCW COB - IP54 WATER RESISTANT - 10 METRE ROLL										
IMAGE	PART NUMBER	CHIP TYPE	IP RATING	LED PER METRE	LUMENS PER METRE	WATTAGE PER METRE	VOLTAGE	MAX LENGTH	CUTTING INCREMENT	SIZE WxH (MM)
	HV9761-IP54-840-RGBCW-10M	COB	IP54	840	500lm	20w/m	24v DC	5M	50mm	12x3
RGBCW COB - IP67 WEATHERPROOF - 10 METRE ROLL										
IMAGE	PART NUMBER	CHIP TYPE	IP RATING	LED PER METRE	LUMENS PER METRE	WATTAGE PER METRE	VOLTAGE	MAX LENGTH	CUTTING INCREMENT	SIZE WxH (MM)
	HV9761-IP67-840-RGBCW-10M	COB	IP67	840	500lm	20w/m	24v DC	5M	50mm	16x6
HAVIT COMPATIBLE ACCESSORIES										
	See pages 295-306 for compatible drivers. All low voltage products that specify an input of 12v or 24v DC must be used with a suitable LED driver.									
	RGBCW Models can be used with any RGBCW Controller in LED Controller section of this catalogue.									
ALL LED STRIP MUST BE INSTALLED ON AN ALUMINIUM HEAT DISSIPATING SURFACE										
	HV9705-1003	10mm x 3mm Aluminum Heat Sink per metre (Max: 3 metre length)								
	HV9705-1603	16mm x 3mm Aluminum Heat Sink per metre (Max: 3 metre length)								



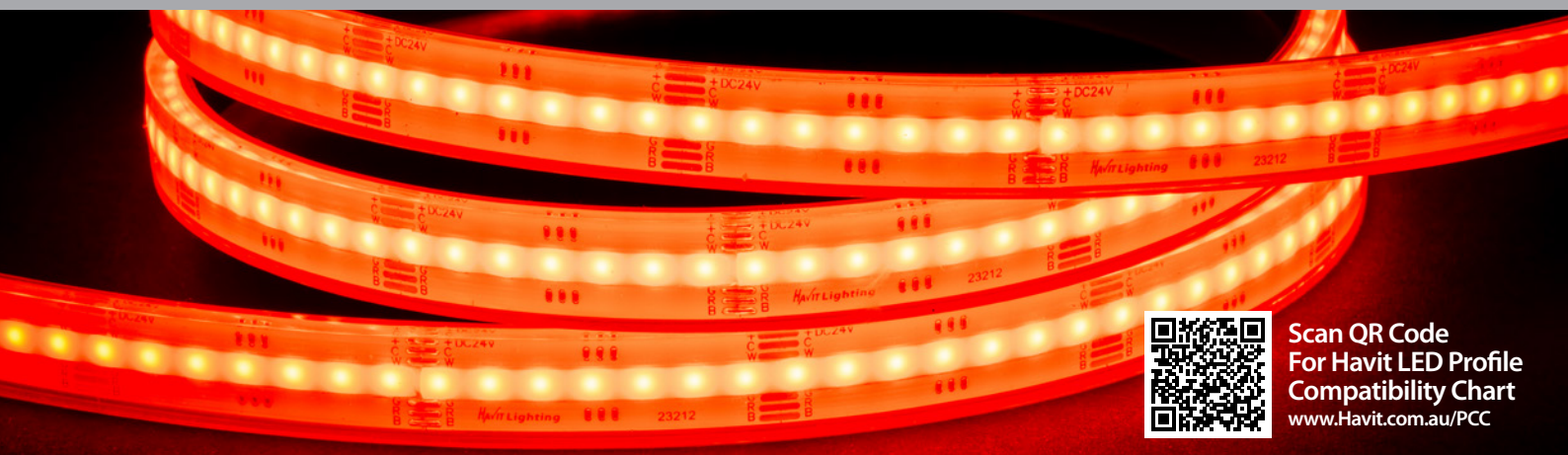

Scan QR Code
For Havit LED Profile
Compatibility Chart
www.Havit.com.au/PCC

Multi Colour RGBCW LED Strip Lighting

- LED flexible strip light
- Colours selected using Havit LED controllers
- Peel and stick backing for initial placement
- Beam angle 120 degrees



RGBC + RGBW COB - IP20 INDOOR - CUSTOM CUT TO LENGTH

IMAGE	PART NUMBER	CHIP TYPE	IP RATING	LED PER METRE	LUMENS PER METRE	WATTAGE PER METRE	VOLTAGE	MAX LENGTH	CUTTING INCREMENT	SIZE WxH (MM)
	HV9761-IP20-840-RGBCW	COB	IP20	840	500lm	20w/m	24v DC	5M	50mm	12x2

RGBC + RGBW COB - IP54 WATER RESISTANT - CUSTOM CUT TO LENGTH

IMAGE	PART NUMBER	CHIP TYPE	IP RATING	LED PER METRE	LUMENS PER METRE	WATTAGE PER METRE	VOLTAGE	MAX LENGTH	CUTTING INCREMENT	SIZE WxH (MM)
	HV9761-IP54-840-RGBCW	COB	IP54	840	500lm	20w/m	24v DC	5M	50mm	12x3

RGBC + RGBW COB - IP67 WEATHERPROOF - CUSTOM CUT TO LENGTH

IMAGE	PART NUMBER	CHIP TYPE	IP RATING	LED PER METRE	LUMENS PER METRE	WATTAGE PER METRE	VOLTAGE	MAX LENGTH	CUTTING INCREMENT	SIZE WxH (MM)
	HV9761-IP67-840-RGBCW	COB	IP67	840	500lm	20w/m	24v DC	5M	50mm	16x6

HAVIT COMPATIBLE ACCESSORIES

	See pages 295-306 for compatible drivers. All low voltage products that specify an input of 12v or 24v DC must be used with a suitable LED driver.
	RGBCW Models can be used with any RGBCW Controller in LED Controller section of this catalogue.

ALL LED STRIP MUST BE INSTALLED ON AN ALUMINIUM HEAT DISSIPATING SURFACE

	HV9705-1003	10mm x 3mm Aluminum Heat Sink per metre (Max: 3 metre length)
	HV9705-1603	16mm x 3mm Aluminum Heat Sink per metre (Max: 3 metre length)

CUSTOM CUT ORDERS AVAILABLE

All custom cut orders require minimum of 48hrs production time from order confirmation, plus delivery time.



For detailed product specifications
visit www.Havit.com.au
or scan this QR code



Scan QR Code
For Havit LED Profile
Compatibility Chart
www.Havit.com.au/PC

5w COB VIPER Strip Kits

- Viper LED flexible strip light kits
- Triac Dimmable Driver complete with Flex and Plug
- Peel and stick backing for initial placement
- Beam angle 120 degrees



5W 3000K COB LED STRIP LIGHTING KITS

IMAGE	LENGTH	PART NUMBER	SMD	IP RATING	LED PER METRE	LUMENS PER METRE	VOLTAGE	POWER	TOTAL WATTAGE
	2 mtr	VPR9760IP54-320-2M	COB	IP54	320	400lm	24v DC	5w/m	10w
	5 mtr	VPR9760IP54-320-5M	COB	IP54	320	400lm	24v DC	5w/m	25w

5W 4000K COB LED STRIP LIGHTING KITS

IMAGE	LENGTH	PART NUMBER	SMD	IP RATING	LED PER METRE	LUMENS PER METRE	VOLTAGE	POWER	TOTAL WATTAGE
	2 mtr	VPR9761IP54-320-2M	COB	IP54	320	410lm	24v DC	5w/m	10w
	5 mtr	VPR9761IP54-320-5M	COB	IP54	320	410lm	24v DC	5w/m	25w

5W 5500K COB LED STRIP LIGHTING KITS

IMAGE	LENGTH	PART NUMBER	SMD	IP RATING	LED PER METRE	LUMENS PER METRE	VOLTAGE	POWER	TOTAL WATTAGE
	2 mtr	VPR9762IP54-320-2M	COB	IP54	320	405lm	24v DC	5w/m	10w
	5 mtr	VPR9762IP54-320-5M	COB	IP54	320	405lm	24v DC	5w/m	25w

ALL LED STRIP MUST BE INSTALLED ON AN ALUMINIUM HEAT DISSIPATING SURFACE

	HV9705-1003	10mm x 3mm Aluminum Heat Sink per metre (Max: 3 metre length)
--	--------------------	---





Scan QR Code
For Havit LED Profile
Compatibility Chart
www.Havit.com.au/PCC

10w COB VIPER Strip Kits

- Viper LED flexible strip light kits
- Triac Dimmable Driver complete with Flex and Plug
- Peel and stick backing for initial placement
- Beam angle 120 degrees



10W 3000K COB LED STRIP LIGHTING KITS

IMAGE	LENGTH	PART NUMBER	SMD	IP RATING	LED PER METRE	LUMENS PER METRE	VOLTAGE	POWER	TOTAL WATTAGE
	2mtr	VPR9763IP54-320-2M	COB	IP54	320	800lm	24v DC	10w/m	20w
	5mtr	VPR9763IP54-320-5M	COB	IP54	320	800lm	24v DC	10w/m	50w

10W 4000K COB LED STRIP LIGHTING KITS

IMAGE	LENGTH	PART NUMBER	SMD	IP RATING	LED PER METRE	LUMENS PER METRE	VOLTAGE	POWER	TOTAL WATTAGE
	2mtr	VPR9764IP54-320-2M	COB	IP54	320	810lm	24v DC	10w/m	20w
	5mtr	VPR9764IP54-320-5M	COB	IP54	320	810lm	24v DC	10w/m	50w

10W 5500K COB LED STRIP LIGHTING KITS

IMAGE	LENGTH	PART NUMBER	SMD	IP RATING	LED PER METRE	LUMENS PER METRE	VOLTAGE	POWER	TOTAL WATTAGE
	2mtr	VPR9765IP54-320-2M	COB	IP54	320	805lm	24v DC	10w/m	20w
	5mtr	VPR9765IP54-320-5M	COB	IP54	320	805lm	24v DC	10w/m	50w

ALL LED STRIP MUST BE INSTALLED ON AN ALUMINIUM HEAT DISSIPATING SURFACE

	HV9705-1003	10mm x 3mm Aluminum Heat Sink per metre (Max: 3 metre length)
--	--------------------	---



For detailed product specifications
visit www.Havit.com.au
or scan this QR code





7.2w RGBCW HaviSMART VIPER Strip Kits

- 7.2w RGBCW HaviSMART Viper Kit
- Viper LED Flexible strip light kit
- Complete with LED Driver and Remote
- Can be used with TUYA App for complete control using Phone or tablet
- Beam angle 120 degrees



Smart Strip Kit Comes Complete with LED Driver, Dedicated Remote and Receiver.



7.2W RGBCW LED STRIP LIGHTING KITS

IMAGE	LENGTH	PART NUMBER	SMD	IP RATING	LED PER METRE	LUMENS PER METRE	VOLTAGE	POWER	TOTAL WATTAGE
	5mtr	VPR9752IP54-72-5M	5050	IP54	72	300lm	12v DC	7.2w	36w

ALL LED STRIP MUST BE INSTALLED ON AN ALUMINIUM HEAT DISSIPATING SURFACE

	HV9705-1003	10mm x 3mm Aluminum Heat Sink per metre (Max: 3 metre length)
---	--------------------	---



For detailed product specifications visit www.Havit.com.au or scan this QR code

Coloured LED Globe

- 5w LED Globe
- Available in Red, Green and Blue
- GU10 or MR16 options
- Triac Dimmable for GU10 models
- 60° Beam Angle

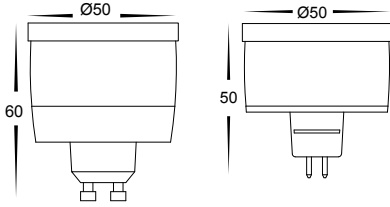





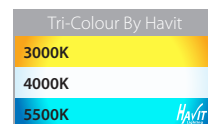
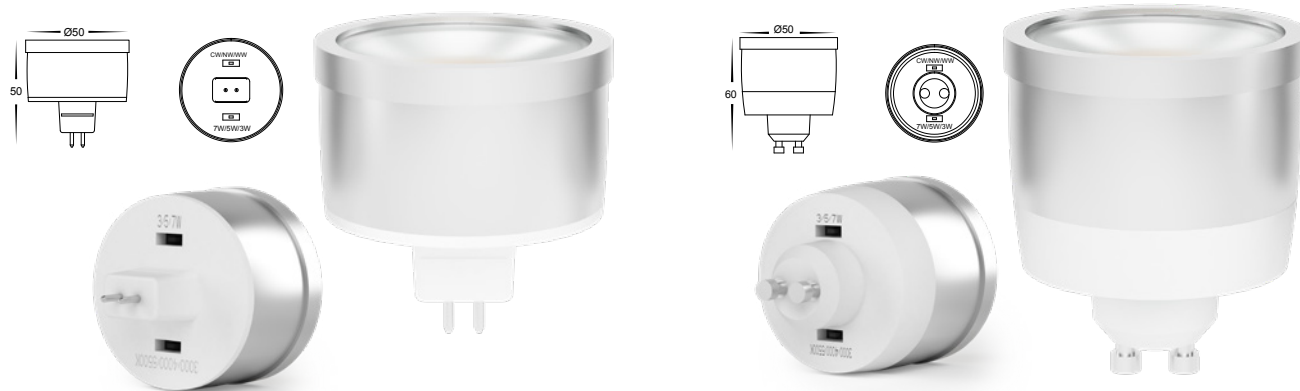

IMAGE	PART NUMBER	POWER	COLOUR	LUMENS	INPUT
	HV9506R	5W	RED	50lm	240v
	HV9506G	5W	GREEN	45lm	240v
	HV9506B	5W	BLUE	35lm	240v
IMAGE	PART NUMBER	POWER	COLOUR TEMP	LUMENS	INPUT
	HV9507R	5W	RED	50lm	12v DC
	HV9507G	5W	GREEN	45lm	12v DC
	HV9507B	5W	BLUE	35lm	12v DC





Tri-Colour 9in1 LED Globe

- 3w, 5w & 7w option all in one globe
- Tri-Colour + 3 Power settings 9in1
- Ability to select 3000K, 4000K and 5500K
- 60° Beam angle
- Triac Dimmable (HV9506D Only)

NEW 9in1 Tri-Colour Globes

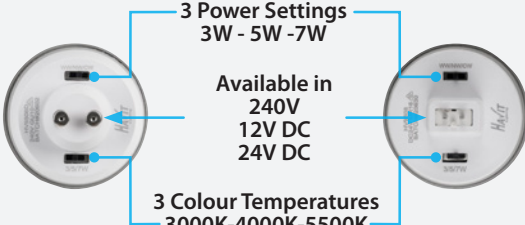

3 Power Settings
3W - 5W - 7W

Available in
240V
12V DC
24V DC

3 Colour Temperatures
3000K-4000K-5500K

IMAGE	PART NUMBER	POWER	COLOUR TEMP	LUMENS	INPUT
	HV9506D	3W	3000K 4000K 5500K	240lm 255lm 270lm	240v
		5W	3000K 4000K 5500K	400lm 425lm 450lm	240v
		7W	3000K 4000K 5500K	560lm 595lm 630lm	240v
IMAGE	PART NUMBER	POWER	COLOUR TEMP	LUMENS	INPUT
	HV9507	3W	3000K 4000K 5500K	240lm 255lm 270lm	12v DC
		5W	3000K 4000K 5500K	400lm 425lm 450lm	12v DC
		7W	3000K 4000K 5500K	560lm 595lm 630lm	12v DC
IMAGE	PART NUMBER	POWER	COLOUR TEMP	LUMENS	INPUT
	HV9508	3W	3000K 4000K 5500K	240lm 255lm 270lm	24v DC
		5W	3000K 4000K 5500K	400lm 425lm 450lm	24v DC
		7W	3000K 4000K 5500K	560lm 595lm 630lm	24v DC



For detailed product specifications
visit www.Havit.com.au
or scan this QR code

LED BI PIN

- 3w TRI Colour
- G5.3
- Beam Angle: 180°
- IP20

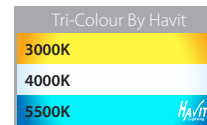

IMAGE	PART NUMBER	COLOUR TEMP.	LUMENS	POWER
	HV9518	3000K-4000K-5500K	385lm - 400lm - 395lm	Tri-Colour 3w 12v LED

G4 High Output Bi Pin LED Globes

- 1.4w, 1.5w, 3.2w & 5w SMD LED
- Beam angle: 180°

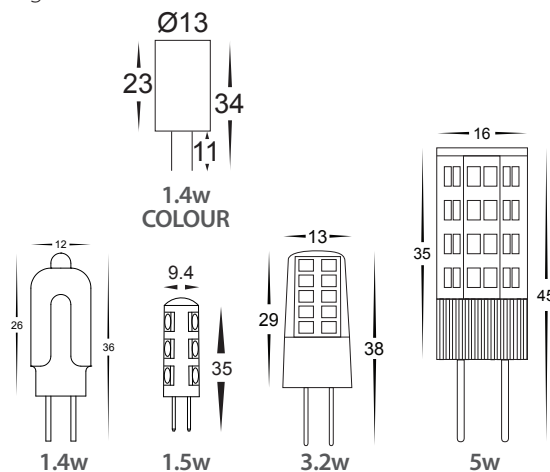

IMAGE	PART NUMBER	COLOUR TEMP.	LUMENS	POWER
	HV9523	5500K	110lm	1.4w LED 12v DC
	HV9523-1.5W	5500K	110lm	1.5w LED 12v DC
	HV9523-3.2W	5500K	260lm	3.2w LED 12v DC
	HV9523-5W	5500K	400lm	5w LED 12v DC
	HV9526	Yellow	NA	1.4w LED 12v DC
	HV9527	Green	NA	1.4w LED 12v DC
	HV9528	Blue	NA	1.4w LED 12v DC
	HV9529	3000K	90lm	1.4w LED 12v DC
	HV9529-1.5W	3000K	90lm	1.5w LED 12v DC
	HV9529-3.2W	3000K	240lm	3.2w LED 12v DC
	HV9529-5W	3000K	360lm	5w LED 12v DC



RGB LED Globe & Remote Control

- 5w RGB LED
- Supplied with multi function IR remote
- 16 colours in one
- 21 colour change mode
- 30° Beam angle



IMAGE	PART NUMBER	COLOUR TEMP	LUMENS	POWER
	HV95021-12V	Multi Colour	NA	RGB, 5w LED 12v DC MR16
	HV95021-240V	Multi Colour	NA	RGB, 5w LED 240v GU10

2w G9 LED Globes

- Direct replacement for halogen G9
- 180° beam angle

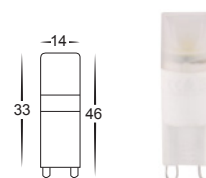

IMAGE	PART NUMBER	COLOUR TEMP	LUMENS	POWER
	HV9511C	5500K	130lm	2w LED 240v G9
	HV9511W	3000K	120lm	2w LED 240v G9

3w MR11 LED Globes

- Energy saving 2w LED globe
- 60° beam angle

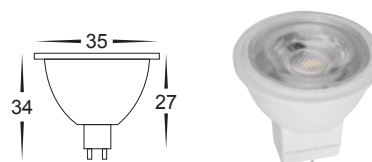

IMAGE	PART NUMBER	COLOUR TEMP	LUMENS	POWER
	HV9311C	5500K	310lm	3w LED 12v DC MR11
	HV9311N	4000K	300lm	3w LED 12v DC MR11
	HV9311W	3000K	270lm	3w LED 12v DC MR11

A60 LED Filament Globe

- Triac Dimmable
- 240 E27 8w

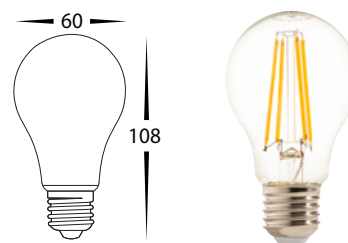

IMAGE	PART NUMBER	COLOUR TEMP	LUMENS	POWER
	HV9569C	5500K	810lm	8w LED 240v E27
	HV9569N	4000K	805lm	8w LED 240v E27
	HV9569W	2700K	800lm	8w LED 240v E27



For detailed product specifications
visit www.Havit.com.au
or scan this QR code

Bar Canopies by Havit

- Surface mount weight limit: 2kg
- To house LED drivers when used with pendants



Scan QR Code
For Havit Canopy and
LED Driver Compatibility
www.Havit.com.au/BCD

500x50x40mm Rectangular Surface Mount Canopy



HV9705-5050-SCH

500x50x40mm Rectangular Surface Mount Canopy



HV9705-5050-WHT

500x50x40mm Rectangular Surface Mount Canopy



HV9705-5050-BLK

800x50x40mm Rectangular Surface Mount Canopy



HV9705-5080-SCH

800x50x40mm Rectangular Surface Mount Canopy



HV9705-5080-WHT

800x50x40mm Rectangular Surface Mount Canopy



HV9705-5080-BLK



Canopies by Havit

- Surface mount weight limit: 2kg
- Recessed weight limit: 1kg
- Recessed cut out: 90mm

<p>70mm Round Surface Mount</p>  <p>HV9705-7023-BLK</p>	<p>70mm Round Surface Mount</p>  <p>HV9705-7023-SCH</p>	<p>70mm Round Surface Mount</p>  <p>HV9705-7023-WHT</p>
<p>100mm Round Surface Mount</p>  <p>HV9705-9025-BLK-RND</p>	<p>100mm Round Surface Mount</p>  <p>HV9705-9025-SCH-RND</p>	<p>100mm Round Surface Mount</p>  <p>HV9705-9025-WHT-RND</p>
<p>100x100mm Square Surface Mount</p>  <p>HV9705-9025-BLK-SQ</p>	<p>100x100mm Square Surface Mount</p>  <p>HV9705-9025-SCH-SQ</p>	<p>100x100mm Square Surface Mount</p>  <p>HV9705-9025-WHT-SQ</p>
<p>100mm Round Recessed 90mm cutout</p>  <p>HV9705-9005-BLK-RND</p>	<p>100mm Round Recessed 90mm cutout</p>  <p>HV9705-9005-SCH-RND</p>	<p>100mm Round Recessed 90mm cutout</p>  <p>HV9705-9005-WHT-RND</p>
<p>100x100mm Square Recessed 90mm cutout</p>  <p>HV9705-9005-BLK-SQ</p>	<p>100x100mm Square Recessed 90mm cutout</p>  <p>HV9705-9005-SCH-SQ</p>	<p>100x100mm Square Recessed 90mm cutout</p>  <p>HV9705-9005-WHT-SQ</p>



For detailed product specifications
visit www.Havit.com.au
or scan this QR code

Accessories

IMAGE	PART NUMBER	DESCRIPTION	IP RATING
	HV1437-TOP	Replacement glass to suit HV1437 & HV1438	NA
	HV350-SPK	Optional garden spike to suit: HV1494C, HV1494W and HV1494RGB	NA
	HV1607	<ul style="list-style-type: none"> • Bollard spike • High grade stainless steel • 400mm Length • Includes stainless steel base plate 	NA
	HV9971	<ul style="list-style-type: none"> • Maintenance kit recommended for all stainless steel luminaires • Kit will clean and protect 	NA
	HV9911	<ul style="list-style-type: none"> • Suitable Wires • 22-10AWG / 0.3247-5.26 mm² • Waterproof and corrosion proof-IP67. • Pre-filled non hardening silicone gel • Eliminates need for heat shrink, tape or sealants. • Can be used with 12v DC or 24v DC 	IP67
	HV9912	<ul style="list-style-type: none"> • Suitable Wires • 22-8AWG / 0.3247-8.37 mm² • Waterproof and corrosion proof-IP67. • Pre-filled non hardening silicone gel • Eliminates need for heat shrink, tape or sealants. • Can be used with 12v DC or 24v DC 	IP67
	HV9913	<ul style="list-style-type: none"> • Suitable Wires • 22-6AWG / 0.3247-13.3 mm² • Waterproof and corrosion proof-IP67. • Pre-filled non hardening silicone gel • Eliminates need for heat shrink, tape or sealants. • Can be used with 12v DC or 24v DC 	IP67
	HV9905	<ul style="list-style-type: none"> • Junction Box • IP Rating: IP65 	IP65
	HV9941-5PK	Ezi Tail connector to suit IP20 8mm LED Strip - 5 Pack	IP20
	HV9941-10PK	Ezi Tail connector to suit IP20 8mm LED Strip - 10 Pack	IP20
	HV9942-5PK	Ezi Tail connector to suit IP20 10mm LED Strip - 5 Pack	IP20
	HV9942-10PK	Ezi Tail connector to suit IP20 10mm LED Strip - 10 Pack	IP20
	HV9945-10PK	Ezi Tail connector to suit IP20 RGBC & RGBW LED Strip - 10 Pack	IP20
	HV9705-9955	2 core low voltage suspension cable to suit HV9705-9956	IP20
	HV9705-9954-BLK	Black Suspension Cable to Suit Suspension Kits	IP20
	HV9705-9954-WHT	White Suspension Cable to Suit Suspension Kits	IP20



Accessories

IMAGE	PART NUMBER	DESCRIPTION	IP RATING
	HV9705-9955-BLK	2 Core Powered Suspension Cable to Suit HV9705-9956-BLK	IP20
	HV9705-9955-WHT	2 Core Powered Suspension Cable to Suit HV9705-9956-WHT	IP20
	HV9705-9956-BLK	Suspension Kit to suit HV9705-9955-BLK	IP20
	HV9705-9956-WHT	Suspension Kit to suit HV9705-9955-WHT	IP20
	HV9705-9956	Suspension kit to suit HV9705-9955	IP20
	HV9981	Red & Black Low Voltage Cable - per metre	IP20
	HV9982	RGB Low Voltage Cable - per metre	IP20
	HV9983	RGBC / W Low Voltage Cable - per metre	IP20
	HV9984	2 Core Clear Low Voltage Cable - per metre	IP20
	HV9985	3 Core Clear Cable - per metre	IP20
	HV9985-BLK	3 Core Black Cable - per metre	IP20
	HV9985-WHT	3 Core White Cable - per metre	IP20
	HV9986	3 Core Low Voltage CT Cable	IP20
	HV9988	5 Core cable clear - per metre	IP20
	HV9988-BLK	5 core cable black - per metre	IP20
	HV9988-WHT	5 core cable white - per metre	IP20
	HV9989	5 core outdoor cable to suit RGBW Garden Lights - per metre	IP20
	HV9990	6 core cable white - per metre	IP20
	HV9980	White Low Voltage Cable per metre	IP20
NEW PRODUCT	HV9987	2 core pond light cable	IP20
	HV9991	RGB cable with White outer sheathing for use with LED Strip - Per Metre	IP20
	HV9992	RGBW cable with White outer sheathing for use with LED Strip - Per Metre	IP20
	HV9993	2.5mm 6 core Outdoor Rubber Cable to suit RGBCW Outdoor Lighting Ranges - Per Metre	IP20
	HV9994	RGBCW cable with White outer sheathing for use with LED Strip - Per Metre	IP20



IP (INGRESS PROTECTION) RATINGS GUIDE

SOLIDS		WATER	
	Protected against a solid object greater than 50mm, such as a hand		Protected against vertically falling drops of water. Limited ingress permitted
	Protected against a solid object greater than 12.5mm, such as a finger		Protected against vertically falling drops of water with enclosure tilted 15° from vertical. Limited ingress permitted
	Protected against a solid object greater than 2.5mm, such as a screwdriver		Protected against sprays to 60° from the vertical. Limited ingress permitted
	Protected against a solid object greater than 1.0mm, such as a wire		Protected against water splashed from all directions. Limited ingress permitted
	Dust protected. Limited ingress of dust permitted		Protected against jets of water. Limited ingress permitted
	Dust Tight. Zero ingress of dust permitted		Protected against strong jets of water. Limited ingress permitted
			Protected against the effects of immersion between 15cm and 1m for up to 1hr
			Protected against long periods of immersion under pressure

IP 67

INGRESS PROTECTION

6

7



8

Chart for reference only. Please refer to AS60529. Diagrams used to illustrate the IP Rating do not have any relation to standards or the IP Rating system and should only be used as a guide.

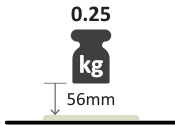
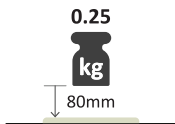
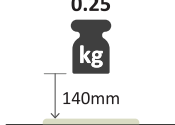
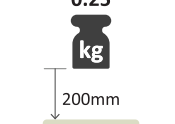
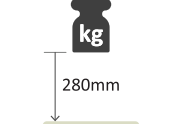
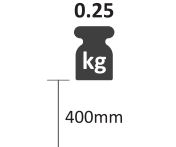
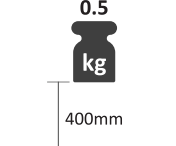
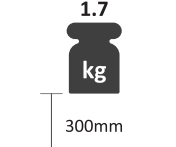

IK RATINGS GUIDE

IK Ratings is the measurement of an object being dropped or fallen onto a fitting from a certain distance and up to a certain weight without the glass breaking.

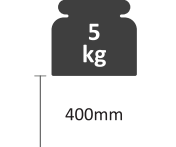
IK CODE	
00	No Protection 
01	Protected against impact of object with weight of up to 0.25kg mass dropped from 56mm above the impacted surface. 
02	Protected against impact of object with weight of up to 0.25kg mass dropped from 80mm above the impacted surface. 
03	Protected against impact of object with weight of up to 0.2kg mass dropped from 140mm above the impacted surface. 
04	Protected against impact of object with weight of up to 0.25kg mass dropped from 200mm above the impacted surface. 
05	Protected against impact of object with weight of up to 0.25kg mass dropped from 280mm above the impacted surface. 
06	Protected against impact of object with weight of up to 0.25kg mass dropped from 400mm above the impacted surface. 
07	Protected against impact of object with weight of up to 0.5kg mass dropped from 400mm above the impacted surface. 
08	Protected against impact of object with weight of up to 1.7kg mass dropped from 300mm above the impacted surface. 
09	Protected against impact of object with weight of up to 5kg mass dropped from 200mm above the impacted surface. 
10	Protected against impact of object with weight of up to 5kg mass dropped from 400mm above the impacted surface. 



For detailed product specifications visit www.Havit.com.au or scan this QR code



www.Havit.com.au

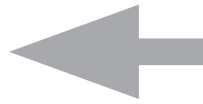

Scan this qr code to to access technical data, specifications, IES files and more product photos to explore the Havit Lighting range in detail

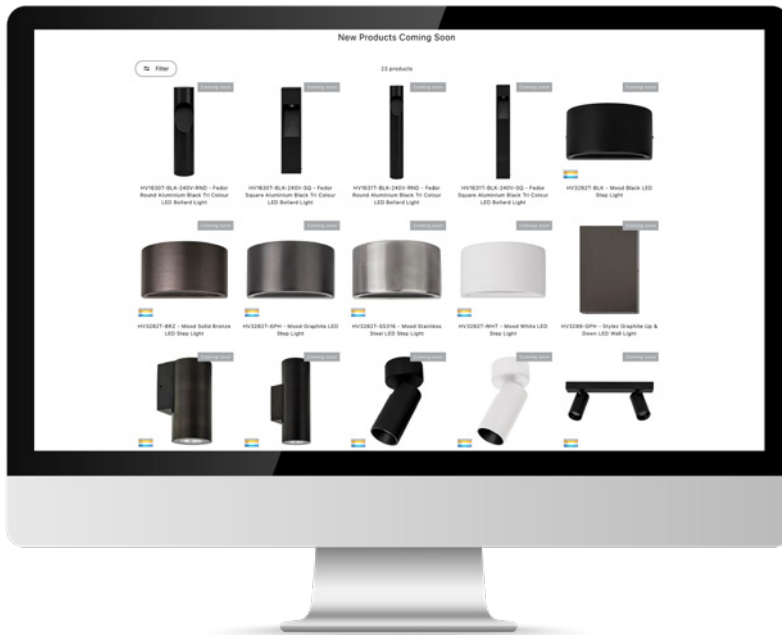

@HavitLighting



@LightingbyHavit



@HavitLighting

www.Havit.com.au





Warranty Terms & Conditions

HAVIT LIGHTING offers 3 years limited replacement warranty on products that fail due to defective materials or workmanship. The warranty period begins from the date of purchase.

**Scan QR code to see
Havit Lighting Warranty Terms & Conditions**



www.Havit.com.au/warranty



*For detailed product specifications
visit www.Havit.com.au
or scan this QR code*

Recommended Routine Maintenance For Stainless Steel Luminaires

Stainless Steel features as the main exterior metal of many luminaires. Many of us recognise that stainless steel is intrinsically attractive, but these fittings require maintenance like all others. Stainless steel enjoys a strong and enduring reputation for long term appearance and structural integrity. But like all materials stainless steel may become stained or discoloured over time, impairing the overall look. This brown discolouration is referred to as "tea staining". Tea staining can be defined as discolouration of the surface to stainless steel that does not affect the structural integrity or the longevity of the material.

Environmental Factors

Tea staining occurs most commonly within about five kilometres of the sea and becomes progressively worse closer to the marine source. However, wind exposure, pollution levels and higher temperatures can create environments where tea staining might occur 20 kilometres or more from the nearest body of seawater. Swimming pool surrounds must also be treated in the same manner, particularly indoor pools. These same factors also increase corrosion rates of alternative materials.

Surface Finish

Rough surface finishes promote tea staining; the smoother the surface, the better. Smoother surface finishes stay cleaner between washes and don't have deep surface grooves where chlorides (salts) and other contaminants can collect and cause staining. Even smooth stainless steel finishes in coastal environments may show tea staining if not washed regularly.

Selecting Stainless Steel Luminaires

Care in the selection of luminaires for any application will avoid problems and disappointment.

Some considerations for selection include: Appropriate Grade Selection. Exposure of a particular grade of stainless steel to a more aggressive environment than it can resist will contribute to tea staining. Grade 316 should be selected as a minimum within five kilometres of the sea. The less expensive grades (such as 304 or 202) will probably become tea stained or even suffer more severe corrosion.

Prevention – Perform Regular Maintenance

Protecting Stainless Steel from corrosion no longer needs to be a chore as there is now a unique treatment containing Nanolon which provides protection for months on end. The Stainless Steel solution is a two part rejuvenation and protection treatment providing long lasting protection to all grades of Stainless Steel. Ideal for the removal and protection of corrosion and 'tea staining' on all grades of internal and external stainless steel.

STEP 1

Using **Stainless Steel Rejuvenating Paste** - the non abrasive formula not only cleans, removes contaminants and rejuvenates the surface, it also pre conditions stainless steel for the protective treatment of (Step 2) Stainless Steel Sentry – the formulation is pH balanced in order to counter any acidic corrosive residues remaining from previous cleaning products and contaminants. The pH balancing aids in the protection of further 'tea staining' and corrosion.

STEP 2

Using **Stainless Steel Sentry** - for all grades of marine and architectural, internal and external stainless steel. Containing the ultra protection concentrate NANOLON. The NANOLON concentrate when applied to the preconditioned stainless steel microscopically coats it and protects it for several months depending on the conditions.

The NANOLON concentrate protects stainless steel from atmospheric corrosion which causes unsightly 'tea staining' and rusting. This product is designed to be used only in conjunction with Stainless Steel Rejuvenating Paste.

We recommend the use of this product on all Stainless Steel Luminaires displayed in this catalogue.



Architectural Copper Oxidation

Why does copper turn green?

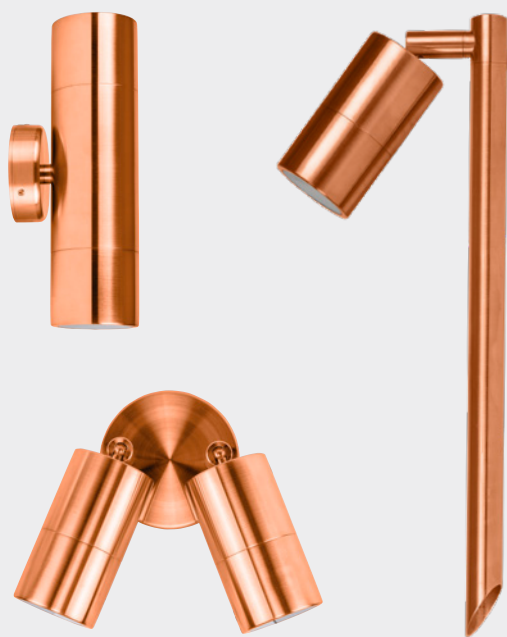

When used outdoors and exposed to the elements, copper transforms from a bright, shiny new penny shade, to a burnished brown, and finally to a distinct green colour. It is this particular effect that attracts architects and designers to use copper. This green finish can most famously be seen on the Statue of Liberty and is seen across many cities on old and new buildings.

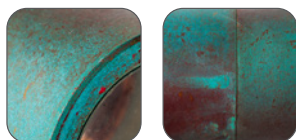

This unique characteristic of copper is completely natural and is often referred to as the “patina” – which refers to the way copper changes colour and turns green as it ages. This natural process actually preserves the copper and protects it from the outside elements making it an excellent choice for exterior lighting.

Over time copper will naturally change colours – transforming from a shiny brown colour to darker browns, then blues and finally greens after a period of time dependant on fittings location and exposure to the natural elements such as wind and rain. Copper develops this “patina” which protects and preserves the metal underneath.

Natural Oxidation

In the same way rust develops on iron, patina develops on copper when the copper sulphate on the surface interacts with oxygen in the environment. Importantly, unlike rust which corrodes iron, patina actually protects and preserves the copper underneath.

Copper Care

The patina process of copper is completely natural and one of the big draws for people who like its look. However, some people prefer the newer look of copper and this can be restored with the help of readily available cleaning products and a little “elbow grease.”

Buffing is a big part of the cleaning process. There are also many commercial products as well as homemade remedies, including those made with vinegar and lemon juice. You should always start by washing the copper with warm water and gentle soap. Avoid using abrasive cleansers or cloths, as they may scratch the copper.



For detailed product specifications
visit www.Havit.com.au
or scan this QR code

Notes & Updates

A series of horizontal dotted lines for taking notes.



Notes & Updates

A series of horizontal dotted lines for taking notes.



For detailed product specifications
visit www.Havit.com.au
or scan this QR code

Notes & Updates

A series of horizontal dotted lines for taking notes.



Notes & Updates

A series of horizontal dotted lines for writing notes and updates.



2025
Havit.com.au

Lighting By Havit

 @HavitLighting  @LightingbyHavit  @HavitLighting