

2024

LIGHTING
REPUBLIC.

VOLUME 02

Index

BODE

74 Wall Light

CANOPIES

131 Single Canopy
131 Ceiling Plate
132 Recessed Canopy

DOME AIR

18 Wall Light

DOVER

68 3lt Linear Pendant Light
69 4lt Linear Pendant Light
70 Lantern Pendant Light

LILLE

126 Wall Light
129 2lt Wall/Ceiling Light

LUMINA

114 Ceiling Light

ORB

90 Mirror Wall Light
92 Short Arm Wall Light
95 Long Arm Wall Light

ORB AIR

12 Pendant Light

ORB DOME

108 Mirror Wall Light
109 Short Arm Wall Light
110 Long Arm Wall Light

ORB LEDGE

118 Outdoor Wall Light

ORB MAX

25 Pendant Light

ORB SUR

100 Wall Light
103 Mini Wall Light

ORGANIC

30 Pendant Light

PARLOUR

38 Pendant Light
39 Ring Pendant Light
40 Sphere Pendant Light
43 Elong Pendant Light
44 Curve Pendant Light
47 Glass Pendant Light
48 Geo Pendant Light

PARLOUR LITE

52 Pendant Light
53 Ring Pendant Light
54 Sphere Pendant Light
57 Elong Pendant Light
58 Curve Pendant Light
61 Glass Pendant Light
62 Geo Pendant Light

SHADOW

78 Mini Wall Light
81 Long Wall Light
84 Wall Light

STAK

34 Pendant Light

TUVA

122 Outdoor Wall Light

Creating timeless elegance



Established in 2012, Lighting Republic is an Australian born lighting brand, set out to design and manufacture timeless and elegant light fixtures suited to the refined and relaxed way of life down under.

Using honest materials and artisanal manufacturing techniques, the Lighting Republic brand has become synonymous with classic design, quality product and excellent attention to detail.

The products are designed and considered to be used in various types of locations from residential to hospitality and many other commercial applications.

Collections



Orb Air
08

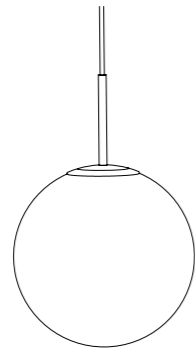

Orb Max
20

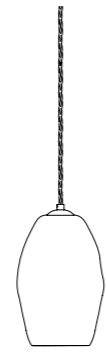

Organic
26

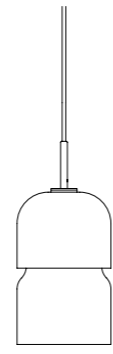

Stak
32

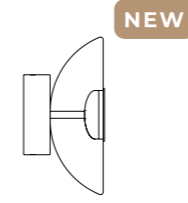

Dome Air
14



Bode
72

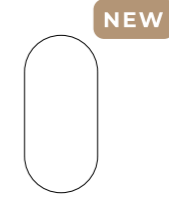

Shadow
76

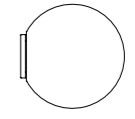

Orb Mirror
90



Parlour
36



Parlour Lite
50

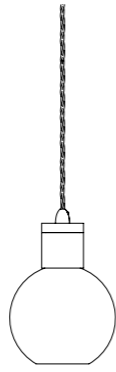

Sphere
40/54



Elong
42/56

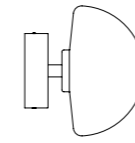

Orb Short Arm
92/109

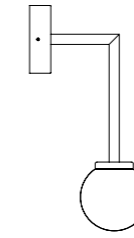

Orb Long Arm
94/110

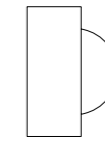

Orb Sur
96

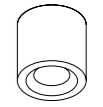

Lumina
112

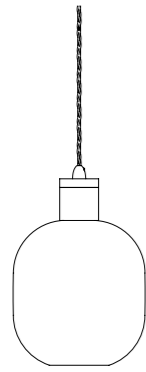

Curve
44/58

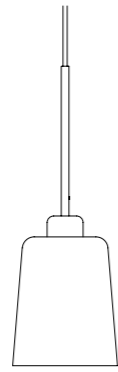

Glass
46/60

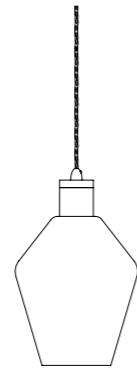

Geo
48/62

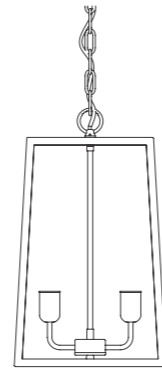

Dover
64

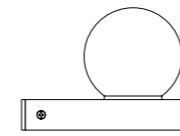

Orb Ledge
116

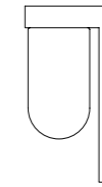

Tuva
120

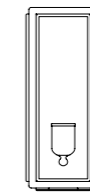

Lille
124

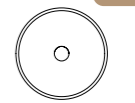

Canopies
130



LIGHTING REPUBLIC

Orb Air Collection

The Orb Air Pendant Light exudes an ethereal charm, where impeccable craftsmanship meets visionary design. Each element has been skilfully crafted to evoke a sense of graceful weightlessness. The borosilicate glass sphere, with its flawless clarity and seamless contour, serves as the centrepiece, capturing and refracting light with an otherworldly allure.

The interplay of light and shadow accentuates its timeless elegance, making it a mesmerising focal point in any setting. Whether suspended alone or clustered in harmonious arrangements, Orb Air transcends the boundaries of contemporary aesthetics, offering a seamless blend of modern sophistication and enduring beauty.

Orb Air
Small, Medium & Large
Clear & Frosted



Bouquet

Orb Air
Small, Medium & Large
Clear

ORB AIR

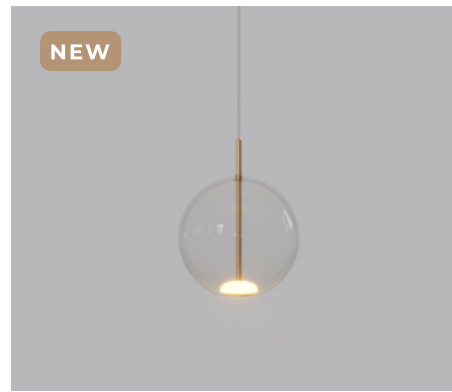

Clear / Small
LR.i02.56.180.CL.OB

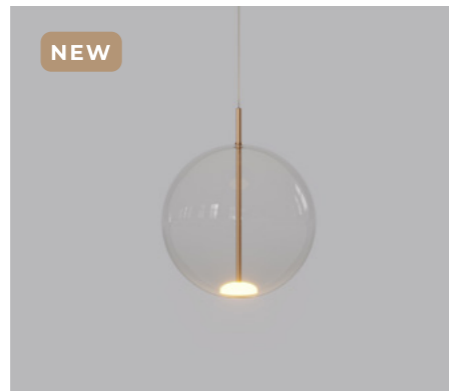

Clear / Medium
LR.i02.56.230.CL.OB

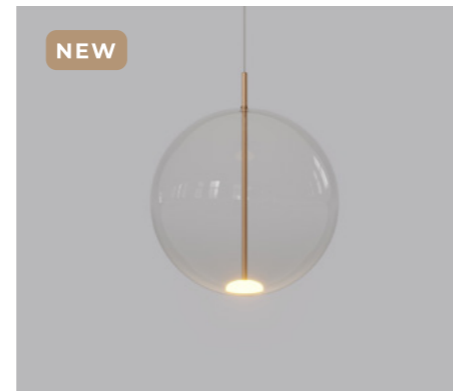

Clear / Large
LR.i02.56.280.CL.OB



Frosted / Small
LR.i02.56.180.FR.OB



Frosted / Medium
LR.i02.56.230.FR.OB



Frosted / Large
LR.i02.56.280.FR.OB

DESCRIPTION

Orb Air Pendant Light showcases a borosilicate glass sphere, meticulously crafted to evoke a sophisticated weightlessness. A refined brass rod intersects the sphere, housing a radiant dimmable LED light source.

Orb Air's familiar yet captivating form emanates a celestial ambience, providing the perfect fusion of contemporary aesthetics and timeless elegance.

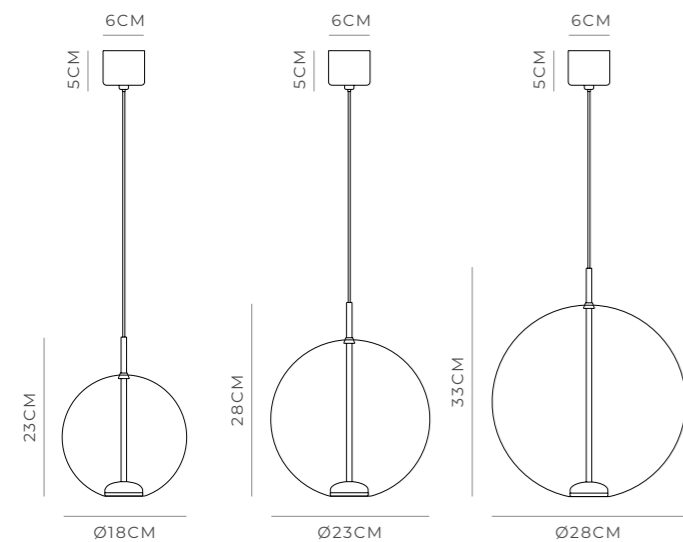

PRODUCT DETAILS

Application
Indoor Pendant Light

Dimensions
Small: H23 x Ø18cm
Medium: H28 x Ø23cm
Large: H33 x Ø28cm

Materials
Shade: Glass
Fixture: Aluminium

Finishes
Shade: Clear or Frosted
Fixture: Old Brass

Light Source
LED 4W 2700K

CRI
+90

Dimming
TRIAC

Cord
Max 600cm

NOTES

Available in three sizes and two different finishes. Orb Air offers versatility in arrangement, whether as individual suspensions, or in cluster combinations.



Orb Air
Medium, Frosted

LIGHTING REPUBLIC

Dome Air Collection

The Dome Air Wall Light embodies a perfect harmony of modern sophistication and minimalism. Each element is meticulously designed to create a sense of refined simplicity. The result is a fixture that exudes an air of understated elegance and timeless versatility.

Whether adorning a hallway, illuminating a living room, or enhancing a bedroom's ambiance, the Dome Air Wall Light seamlessly blends with a variety of interior styles. Its minimalist aesthetic ensures it complements a wide range of interior designs, providing a sophisticated lighting solution that is as beautiful as it is functional.



Dome Air
Clear

DOME AIR

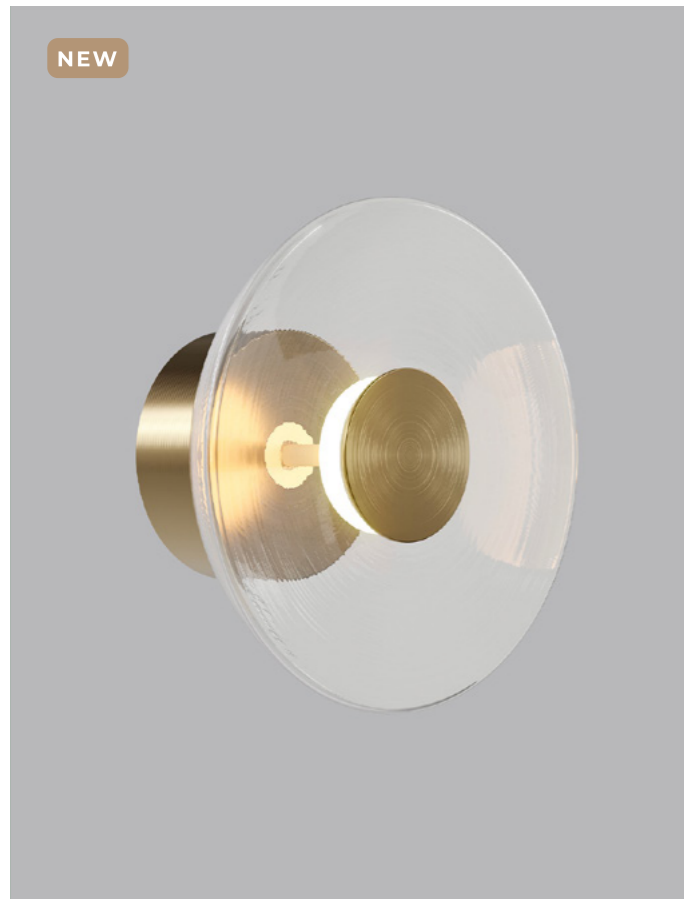

Clear
LR.i01.70.DM.CL.OB



Frosted
LR.i01.70.DM.FR.OB

DESCRIPTION

Dome Air Wall Light features a borosilicate glass shade and a central brass accent. A refined brass rod intersects the shade, housing a dimmable LED light source.

Exuding sophistication and contemporary flair, its minimalist aesthetic lends it a timeless and versatile appeal for any interior space.

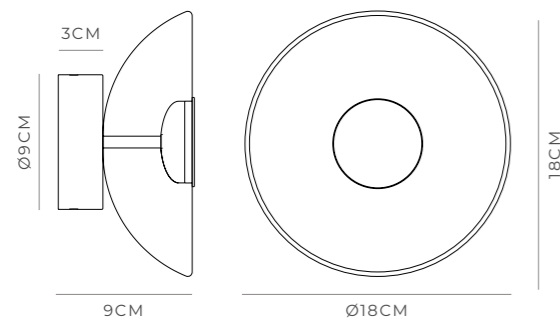

PRODUCT DETAILS

Application
Indoor Wall Light

Dimensions
H18 x W18 x D9CM

Materials
Shade: Borosilicate Glass
Fixture: Aluminium

Finishes
Shade: Clear or Frosted
Fixture: Old Brass

Light Source
LED 4W 2700K

CRI
+90

Dimming
TRIAC

IP Rating
IP44

NOTES

Its IP44 rating makes it suitable for bathrooms, offering protection against moisture.



Dome Air
Clear



LIGHTING REPUBLIC

Orb Max Collection

The Orb Max Collection of pendant lights encompasses the enduring appeal of the glass sphere and exaggerates it in both size and impact. This classic design with its everlasting charm and popularity is a style for the modern age.

Striking in its simplicity and crafted to perfection from white glass with monochromatic accents, the Orb Max collection emits a glow that will permeate a room with softness and warmth. This oversized orb brings an impressive presence to any interior space.

Orb Max
Extra Large, Textured White



Orb Max
Large, Textured White



Orb Max
Large, Textured White



Orb Max
Extra Large, Textured White

ORB MAX



Large / Textured Black
LR.i02.55.L.BL

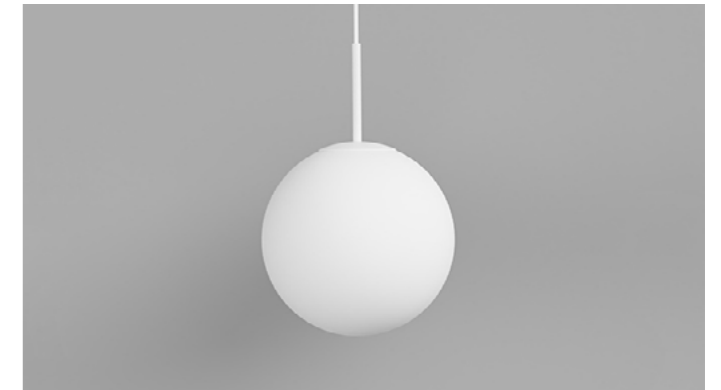

Large / Textured White
LR.i02.55.L.WH



Extra Large / Textured Black
LR.i02.55.XL.BL



Extra Large / Textured White
LR.i02.55.XL.WH

DESCRIPTION

With an emphasis on the curvature and smoothness of a simple sphere, the Orb Max Pendant Light is the perfect addition to any residential or commercial space.

PRODUCT DETAILS

Application
Indoor Pendant Light

Dimensions
Large: Ø30cm
Extra Large: Ø40cm

Materials
Shade: Mouth-Blown Glass
Fixture: Aluminium

Finishes
Shade: White
Fixture: Textured Black or Textured White

Light Source
E27 Max 9W LED

Cord
Max 200cm

NOTES

The delicateness of the pendant's petite cable juxtaposed with the bold circular shape of the pendant lends itself to a minimal and contemporary look.

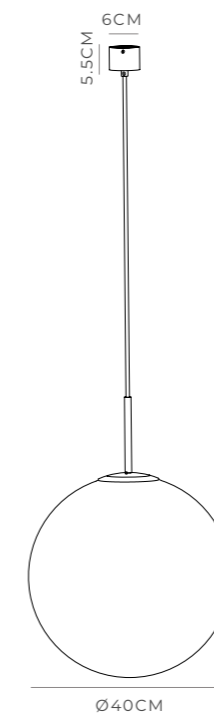

Organic Collection

The Organic collection features a characteristic contour in its form. Energetic and asymmetrical, each glass shade is individually mouth-blown and hand-formed to give it a unique shape - no two pendants are ever the same.

The way that light beams through the contours of each different glass surface provides a thrilling light diffusion.

Presents beautifully as an individual piece or can be used within a cluster arrangement to form an elegant and unique feature.



Organic
Medium & Large
Old Brass, Clear

Organic
Large, Old Brass, White



Organic
Medium, Iron, Clear

ORGANIC



Medium / Old Brass / White
LR.i02.88.M.OB.WH



Medium / Iron / White
LR.i02.88.M.IRN.WH



Large / Old Brass / White
LR.i02.88.L.OB.WH



Large / Iron / White
LR.i02.88.L.IRN.WH



Medium / Old Brass / Clear
LR.i02.88.M.OB



Medium / Iron / Clear
LR.i02.88.M.IRN



Large / Old Brass / Clear
LR.i02.88.L.OB



Large / Iron / Clear
LR.i02.88.L.IRN

DESCRIPTION

The Organic fitting features a bespoke turned and cast brass suspension that is delicately suspended by a twisted black cloth cord and is available in an aged brass or timeless iron finish.

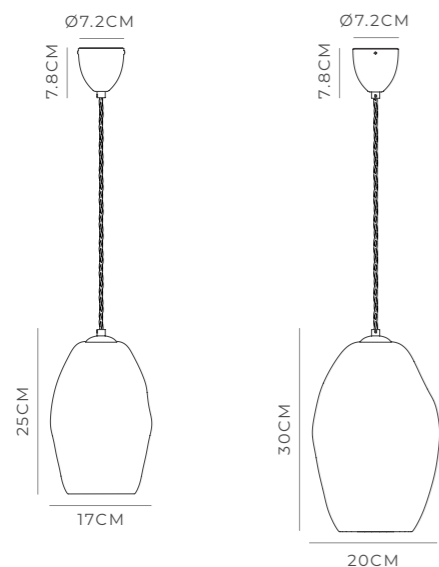

PRODUCT DETAILS

Application
Indoor Pendant Light

Dimensions
Medium: H25 x W17cm
Large: H30 x W20cm

Materials
Shade: Mouth-Blown Glass
Fixture: Brass

Finishes
Shade: Clear or White
Fixture: Old Brass or Iron

Light Source
E27 Max 9W LED

Cord
Max 200cm

NOTES

The varied thickness and unique details in the glass adds a subtle honesty to this product making it truly one of a kind.





LIGHTING REPUBLIC

Stak Collection

The Stak Collection of pendant lights is a modular system that encompasses a structured form with a flexibility in style. With a core focus on the expression of light, each combination of mouth-blown glass shades exquisitely complements the other, thus establishing the narrative for a universally appealing aesthetic.

With the confident air of classic design, this bold and minimal collection will sit comfortably in any contemporary interior setting, as an individual suspension or in composition for a more impactful presence.

Stak
White, Clear

STAK



Clear / Clear
LR.i02.65.T.CL + LR.i02.65.B.CL
+ LR.i02.65.WH.SSP



Smoke / Clear
LR.i02.65.T.SM + LR.i02.65.B.CL
+ LR.i02.65.WH.SSP



White / Clear
LR.i02.65.T.WH + LR.i02.65.B.CL
+ LR.i02.65.WH.SSP



Clear / White
LR.i02.65.T.CL + LR.i02.65.B.WH
+ LR.i02.65.WH.SSP



Smoke / White
LR.i02.65.T.SM + LR.i02.65.B.WH
+ LR.i02.65.WH.SSP



White / White
LR.i02.65.T.WH + LR.i02.65.B.WH
+ LR.i02.65.WH.SSP

DESCRIPTION

Stak Pendant Light is a celebration of versatility, making it ideal for many interiors. The unique and simple form of two stacked mouth-blown glass shades allows the glass to express itself through light. A minimal pendant light with an abundance of style that is sure to become a classic.

PRODUCT DETAILS

Application
Indoor Pendant Light

Dimensions
H38 x Ø18

Materials
Shade: Glass
Fixture: Aluminium

Finishes
Top Shade: Clear, Smoke or White
Base Shade: Clear or White
Fixture: Textured White

Light Source
E27 Max 9W LED

Cord
Max 200cm

NOTES

A configurable fitting, the top shade is available in a clear, smoke, or white finish while the base has a clear or white glass option.

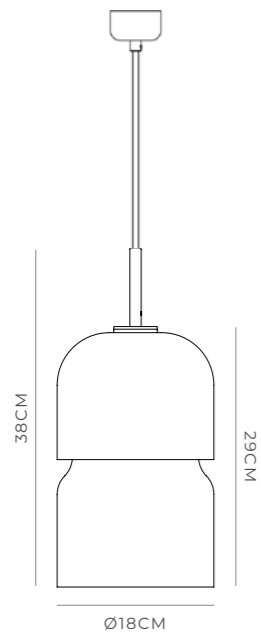

Stak
White, Clear

LIGHTING REPUBLIC

Parlour Collection



Parlour
Iron

The Parlour modular suspension collection is robust and accentuates the simplicity of timeless design. The Parlour collection is crafted from solid brass and presented in old brass and iron finishes. Minimal and versatile, that it can be used on its own or complemented with various accessories.

There is a steadiness in its construction that contrasts vigour and elegance. Parlour is a collection that is steeped in historical inspiration yet leaps forward to the future to create a classic sleek collection.

PARLOUR



Old Brass
LR.i02.25.OB



Iron
LR.i02.25.IRN

DESCRIPTION

The ParLOUR Pendant Light is contemporary and minimal, making it an aesthetically pleasing addition for a variety of interiors. Though it may seem quite small in stature, the sturdiness and detail in its craftsmanship is undeniable.



PRODUCT DETAILS

Application
Indoor Pendant Light

Dimensions
H8.5 x Ø6cm

Materials
Brass

Finishes
Old Brass or Iron

Light Source
E27 Max 9W LED

Cord
Max 200cm

NOTES

Minimal and versatile enough to be fitted with an assortment of accessories. ParLOUR is modular with a wide range of possibilities.

PARLOUR RING



Ring
LR.i02.25.OB + LR.A35.RNG.OB



Ring
LR.i02.25.IRN + LR.A35.RNG.OB

DESCRIPTION

The ParLOUR Ring accessory is made using solid brass and features a smooth and refined textural quality. The Ring accessory transforms the ParLOUR from being understated into a statement piece.

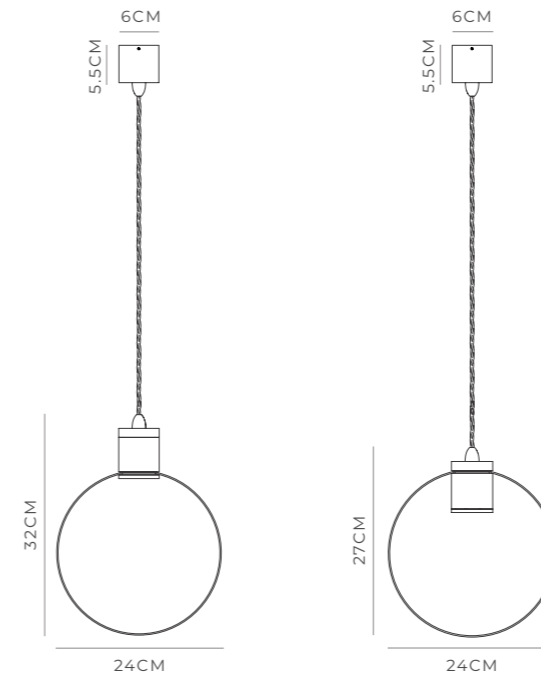

PRODUCT DETAILS

Application
Indoor Pendant Light

Dimensions
Ring: Ø24 x W5cm
Fixture: H8.5 x Ø6cm

Materials
Brass

Finishes
Ring: Old Brass
Fixture: Old Brass or Iron

Light Source
E27 Max 9W LED

Cord
Max 200cm

NOTES

The ParLOUR Ring can be installed in either the top or bottom position for different effects.

PARLOUR SPHERE



Old Brass or Iron / White
LR.i02.25.OB or LR.i02.25.IRN + LR.A01.004.WH



Old Brass or Iron / Clear
LR.i02.25.OB or LR.i02.25.IRN + LR.A01.004.CL



Old Brass or Iron / Smoke
LR.i02.25.OB or LR.i02.25.IRN + LR.A01.004.SM



Old Brass or Iron / Amber
LR.i02.25.OB or LR.i02.25.IRN + LR.A01.004.SM

DESCRIPTION

The Parlour Sphere reveals a luxe detail in the beautifully thick mouth blown glass element that encompasses the globe and transmits a beautiful glow through the glass. Suspended by the solid brass lamp holder, this truly is timeless elegance.

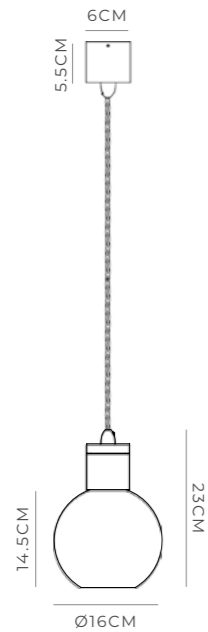

PRODUCT DETAILS

Application
Indoor Pendant Light

Dimensions
Shade: H14.5 x Ø16cm
Fixture: H8.5 x Ø6cm

Materials
Shade: Glass
Fixture: Brass

Finishes
Shade: White, Clear,
Smoke or Amber
Fixture: Old Brass or Iron

Light Source
E27 Max 9W LED

Cord
Max 200cm

NOTES

Glass shades available in four finishes that can be mixed and matched to achieve a unique composition and effect.



Parlour Sphere
Old Brass, Clear



Parlour Elong
Old Brass, Clear

PARLOUR ELONG



Old Brass or Iron / White
LR.i02.25.OB or LR.i02.25.IRN + LR.A01.007.WH



Old Brass or Iron / Clear
LR.i02.25.OB or LR.i02.25.IRN + LR.A01.007.CL



Iron or Old Brass / Smoke
LR.i02.25.IRN or LR.i02.25.OB + LR.A01.007.SM



Iron or Old Brass / Amber
LR.i02.25.IRN or LR.i02.25.OB + LR.A01.007.AM

DESCRIPTION

The Parlour Elong glass is classically transitional and elegantly stylish. The variety of finishes combined with a brass suspension provides a beautiful luxe product suited to many environments.

PRODUCT DETAILS

Application
Indoor Pendant Light

Dimensions
Shade: H36 x Ø12cm
Fixture: H8.5 x Ø6cm

Materials
Shade: Glass
Fixture: Brass

Finishes
Shade: White, Clear,
Smoke or Amber
Fixture: Old Brass or Iron

Light Source
E27 Max 9W LED

Cord
Max 200cm

NOTES

The glass can be installed in two different positions to elongate or shorten the height of the fitting.

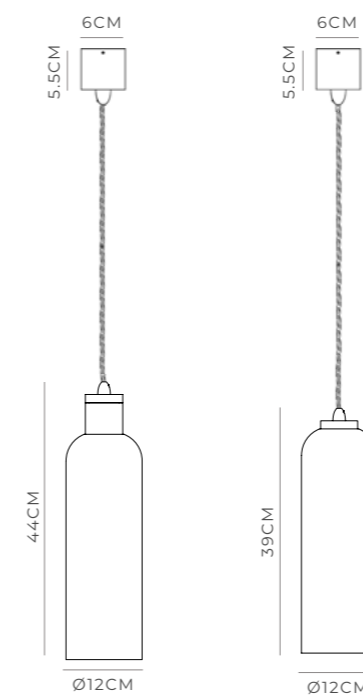

PARLOUR CURVE



Old Brass / White
LR.i02.25.OB + LR.A01.006.WH



Old Brass / Clear
LR.i02.25.OB + LR.A01.006.CL



Old Brass / Smoke
LR.i02.25.OB + LR.A01.006.SM



Iron / White
LR.i02.25.IRN + LR.A01.006.WH



Iron / Clear
LR.i02.25.IRN + LR.A01.006.CL



Iron / Smoke
LR.i02.25.IRN + LR.A01.006.SM

DESCRIPTION

The Parlour Curve offers a timeless elegance in style and a silky softness in mood and tone. As much as it is a statement piece, the Parlour Curve adds a touch of finesse to interiors. The boldness in its form is balanced by the preciseness of its finish.

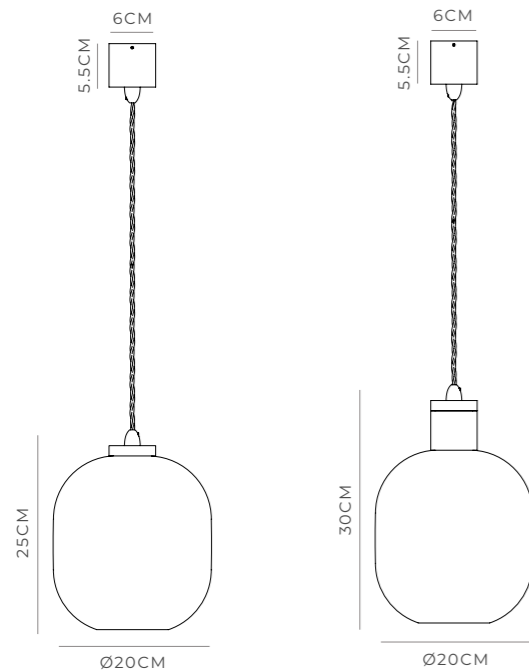

PRODUCT DETAILS

Application
Indoor Pendant Light

Dimensions
Shade: H22 x Ø20cm
Fixture: H8.5 x Ø6cm

Materials
Shade: Glass
Fixture: Brass

Finishes
Shade: White, Clear
or Smoke
Fixture: Old Brass or Iron

Light Source
E27 Max 9W LED

Cord
Max 200cm

NOTES

The glass can be installed in two different positions to elongate or shorten the height of the fitting.



Parlour Curve
Old Brass, Clear



Parlour Glass
Brass, Square - Round

PARLOUR GLASS



Old Brass / Round - Round
LR.i02.25.OB + LR.A01.003



Old Brass / Square - Round
LR.i02.25.OB + LR.A01.002



Old Brass / Square - Square
LR.i02.25.OB + LR.A01.001



Iron / Round - Round
LR.i02.25.IRN + LR.A01.003



Iron / Square - Round
LR.i02.25.IRN + LR.A01.002



Iron / Square - Square
LR.i02.25.IRN + LR.A01.001

DESCRIPTION

The Parlour Glass Pendant Light reveals a contrast of antique flair but with a modern twist. Timeless in its design, the Parlour Glass is a superb selection to complement luxurious motifs within any space.

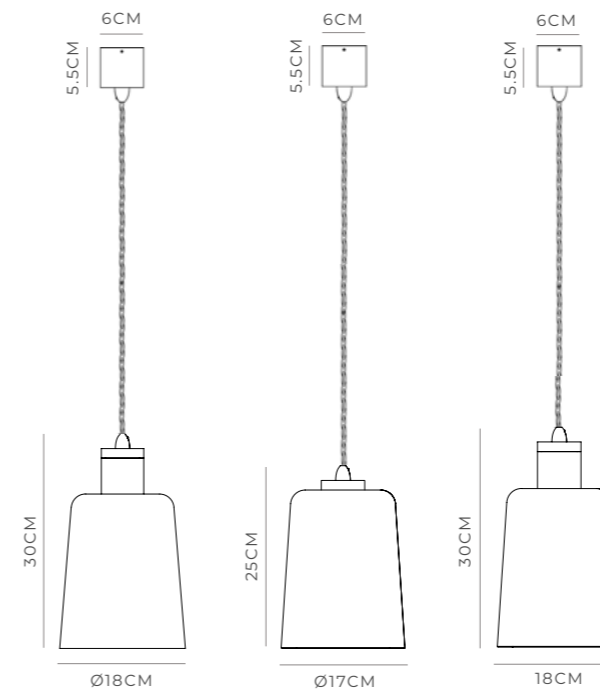

PRODUCT DETAILS

Application
Indoor Pendant Light

Dimensions
Round - Round:
H21.5 x Ø18cm
Square - Round:
H21.5 x Ø17cm
Square - Square:
H21.5 x W18cm
Fixture: H8.5 x Ø6cm

Materials
Shade: Glass
Fixture: Brass

Finishes
Shade: Clear Vintage
Fixture: Old Brass or Iron

Light Source
E27 Max 9W LED

Cord
Max 200cm

NOTES

The glass can be installed in two different positions to elongate or shorten the height of the fitting.

Have a look at the unique shade that has a square top with a round base that reminds us of a luxurious vintage whisky tumbler.

PARLOUR GEO



Old Brass / White
LR.i02.25.OB + LR.A01.005.WH



Old Brass / Clear
LR.i02.25.OB + LR.A01.005.CL



Iron / White
LR.i02.25.IRN + LR.A01.005.WH



Iron / Clear
LR.i02.25.IRN + LR.A01.005.CL

DESCRIPTION

The Parlour Geo Pendant Light is contemporary and minimal with a shade that features a geometric shape that has been streamlined by its smooth curves to counteract its angularity.

PRODUCT DETAILS

Application
Indoor Pendant Light

Dimensions
Shade: H26 x Ø21cm
Fixture: H8.5 x Ø6cm

Materials
Shade: Glass
Fixture: Brass

Finishes
Shade: White or Clear
Fixture: Old Brass or Iron

Light Source
E27 Max 9W LED

Cord
Max 200cm

NOTES

The glass can be installed in two different positions to elongate or shorten the height of the fitting.

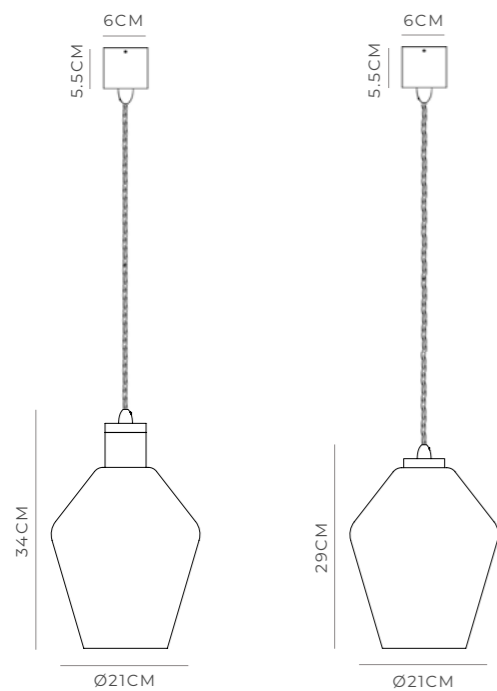

Parlour Geo
Old Brass, White

LIGHTING REPUBLIC

Parlour Lite Collection



Parlour Lite Curve
Textured Black, White

Complementing our signature Parlour Collection is the Parlour Lite Collection, where the suspension presents a sleek, architectural and contemporary aesthetic. Though it may seem quite understated, the sturdiness and detail in its craftsmanship is undeniable.

The core essence that runs throughout this collection is that it is monochromatic. Allowing it to be an aesthetically pleasing addition for a wide variety of interiors. Minimal and versatile enough to be fitted with an assortment of accessories.

PARLOUR LITE



Textured Black
LR.i02.26.BL



Textured White
LR.i02.26.WH

DESCRIPTION

The Parlour Lite Pendant Light is sleek and contemporary, making it an aesthetically pleasing addition for a variety of interiors. Though it may seem quite understated, the sturdiness and detail in its craftsmanship is undeniable.

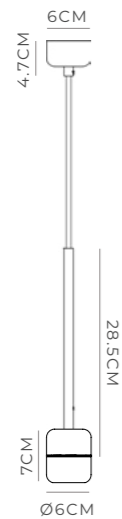

PRODUCT DETAILS

Application
Indoor Pendant Light

Dimensions
H7 x Ø6cm

Materials
Aluminium

Finishes
Textured Black
or Textured White

Light Source
E27 Max 9W LED

Cord
Max 200cm

NOTES

Minimal and versatile enough to be fitted with an assortment of accessories. Parlour Lite is modular with a wide range of possibilities.

PARLOUR LITE RING



Textured Black
LR.i02.26.BL + LR.A35.RNG.OB



Textured White
LR.i02.26.WH + LR.A35.RNG.OB

DESCRIPTION

The Parlour Lite Ring is carefully formed in solid brass with a textural quality that is smooth and refined. A subtle accessory to enhance any space.

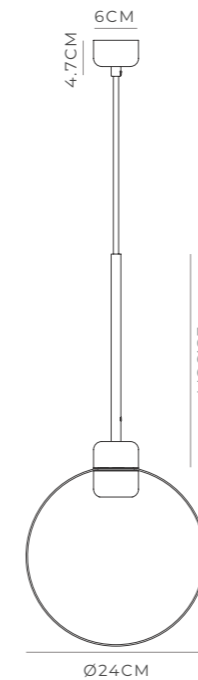

PRODUCT DETAILS

Application
Indoor Pendant Light

Dimensions
Ring: Ø24 x W5cm
Fixture: H7 x Ø6cm

Materials
Ring: Brass
Fixture: Aluminium

Finishes
Ring: Old Brass
Fixture: Textured Black
or Textured White

Light Source
E27 Max 9W LED

Cord
Max 200cm

NOTES

The Parlour Lite Ring is a hybrid of the Lite suspension with the Ring accessory.

PARLOUR LITE SPHERE



Textured Black or Textured White / White
LR.i02.26.BL or LR.i02.26.WH + LR.A01.004.WH



Textured Black or Textured White / Clear
LR.i02.26.BL or LR.i02.26.WH + LR.A01.004.CL



Textured Black or Textured White / Smoke
LR.i02.26.BL or LR.i02.26.WH + LR.A01.004.SM



Textured Black or Textured White / Amber
LR.i02.26.BL or LR.i02.26.WH + LR.A01.004.AM

DESCRIPTION

The compact suspension combined with the thick glass sphere add an architectural elegance to any interior space. Can be used as an individual piece or in a cluster for more impact.

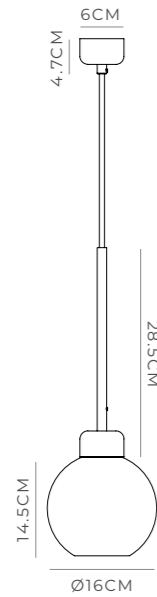

PRODUCT DETAILS

Application
Indoor Pendant Light

Dimensions
Shade: H14.5 x Ø16cm
Fixture: H7 x Ø6cm

Materials
Shade: Glass
Fixture: Aluminium

Finishes
Shade: White, Clear, Smoke or Amber
Fixture: Textured Black or Textured White

Light Source
E27 Max 9W LED

Cord
Max 200cm

NOTES

The ParLOUR Lite Sphere is a hybrid of the Lite suspension with the Sphere glass shade.



ParLOUR Lite Sphere
Textured White,
White, Clear, Smoke & Amber

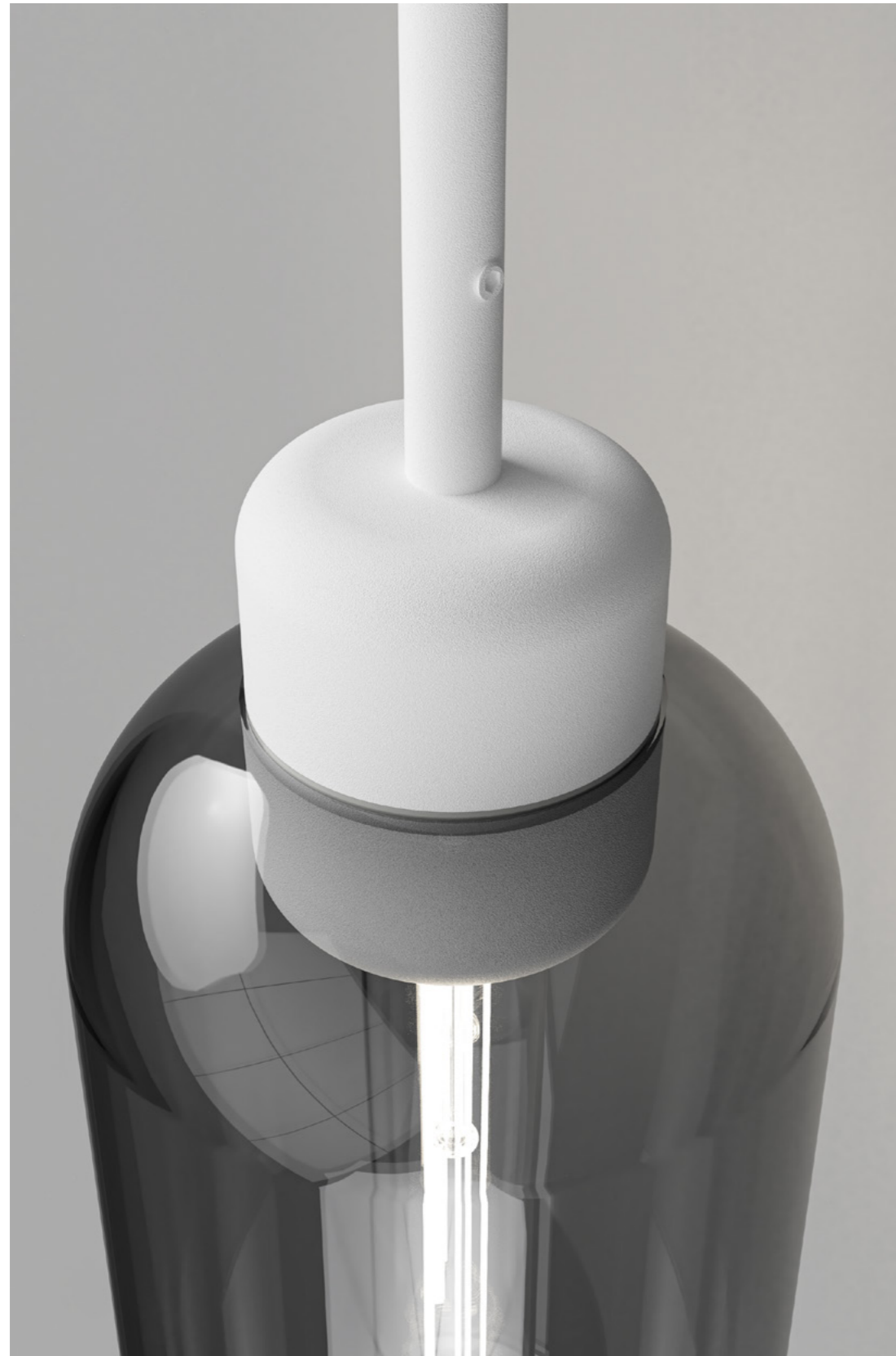

Parlour Lite Curve
Textured White, Smoke

PARLOUR LITE ELONG



Textured Black or Textured White / White
LR.i02.26.BL or LR.i02.26.WH + LR.A01.007.WH



Textured Black or Textured White / Clear
LR.i02.26.BL or LR.i02.26.WH + LR.A01.007.CL



Textured Black or Textured White / Smoke
LR.i02.26.BL or LR.i02.26.WH + LR.A01.007.SM



Textured Black or Textured White / Amber
LR.i02.26.BL or LR.i02.26.WH + LR.A01.007.AM

DESCRIPTION

The compact suspension is sleek and contemporary while the shade reveals a contrast of antique flair with a modern twist through its elongated form.

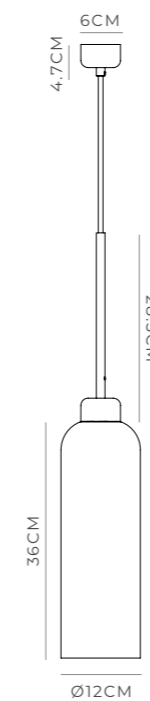

PRODUCT DETAILS

Application
Indoor Pendant Light

Dimensions
Shade: H36 x Ø12cm
Fixture: H7 x Ø6cm

Materials
Shade: Glass
Fixture: Aluminium

Finishes
Shade: White, Clear,
Smoke or Amber
Fixture: Textured Black
or Textured White

Light Source
E27 Max 9W LED

Cord
Max 200cm

NOTES

The Parlour Lite Elong Pendant is a hybrid of the Lite suspension with the Elong glass shade.

PARLOUR LITE CURVE



Textured White / White
LR.i02.26.WH + LR.A01.006.WH



Textured White / Clear
LR.i02.26.WH + LR.A01.006.CL



Textured White / Smoke
LR.i02.26.WH + LR.A01.006.SM



Textured Black / White
LR.i02.26.BL + LR.A01.006.WH



Textured Black / Clear
LR.i02.26.BL + LR.A01.006.CL



Textured Black / Smoke
LR.i02.26.BL + LR.A01.006.SM

DESCRIPTION

The compact suspension is sleek and contemporary while the shade could be seen as ample due to its shape but in contrast, is subtle in personality.

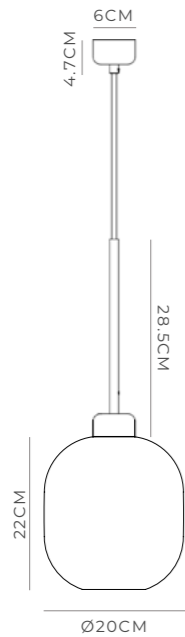

PRODUCT DETAILS

Application
Indoor Pendant Light

Dimensions
Shade: H22 x W20cm
Fixture: H7 x Ø6cm

Materials
Shade: Glass
Fixture: Aluminium

Finishes
Shade: White, Clear
or Smoke
Fixture: Textured Black
or Textured White

Light Source
E27 Max 9W LED

Cord
Max 200cm

NOTES

The Parlour Lite Curve is a hybrid of the Lite suspension with the Curve glass shade.



Parlour Lite Curve
Textured Black, White



ParLOUR Lite Glass
Textured White, Round Round

PARLOUR LITE GLASS



Textured Black / Round - Round
LR.i02.26.BL + LR.A01.003



Textured Black / Square - Round
LR.i02.26.BL + LR.A01.002



Textured Black / Square - Square
LR.i02.26.BL + LR.A01.001



Textured White / Round - Round
LR.i02.26.WH + LR.A01.003



Textured White / Square - Round
LR.i02.26.WH + LR.A01.002



Textured White / Square - Square
LR.i02.26.WH + LR.A01.001

DESCRIPTION

The ParLOUR Lite Glass Pendant reveals a contrast of vintage flair but with a modern twist. Timeless in its design, the ParLOUR Lite Glass is a superb selection to complement luxurious motifs within any space.

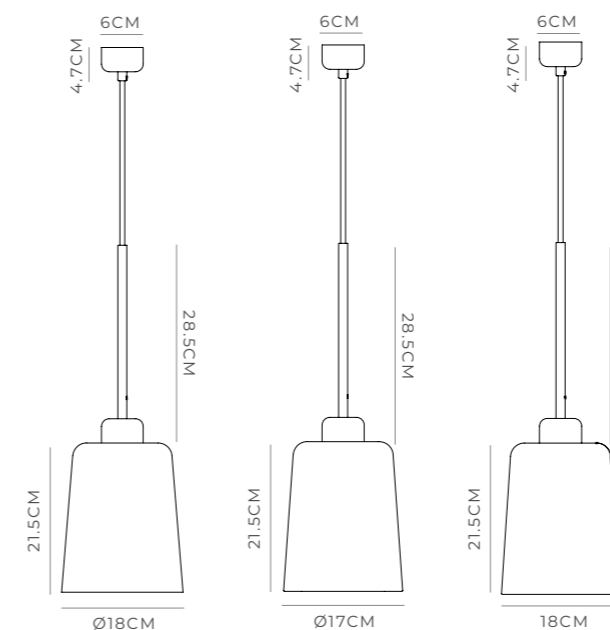

PRODUCT DETAILS

Application
Indoor Pendant Light

Dimensions
Round - Round:
H21.5 x Ø18cm
Square - Round:
H21.5 x Ø17cm
Square - Square:
H21.5 x W18cm
Fixture: H7 x Ø6cm

Materials
Shade: Glass
Fixture: Aluminium

Finishes
Shade: Clear Vintage
Fixture: Textured Black
or Textured White

Light Source
E27 Max 9W LED

Cord
Max 200cm

NOTES

The ParLOUR Lite Glass is a hybrid of the Lite suspension with one of the three differently shaped glass shades.

PARLOUR LITE GEO



Textured Black / White
LR.i02.26.BL + LR.A01.005.WH



Textured Black / Clear
LR.i02.26.BL + LR.A01.005.CL



Textured White / White
LR.i02.26.WH + LR.A01.005.WH



Textured White / Clear
LR.i02.26.WH + LR.A01.005.CL

DESCRIPTION

The compact suspension is sleek and contemporary while the shade features a geometric shape that has been streamlined by its smooth curves to counteract its angularity.

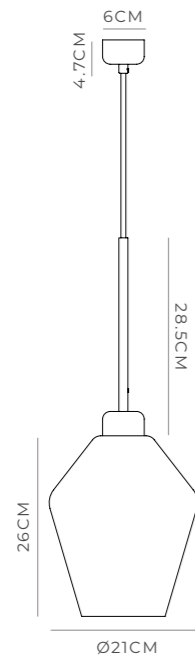

PRODUCT DETAILS

Application
Indoor Pendant Light

Dimensions
Shade: H26 x W21cm
Fixture: H7x Ø6cm

Materials
Shade: Glass
Fixture: Aluminium

Finishes
Shade: White or Clear
Fixture: Textured Black
or Textured White

Light Source
E27 Max 9W LED

Cord
Max 200cm

NOTES

The ParLOUR Lite Geo is a hybrid of the Lite suspension with the Geo glass shade.



ParLOUR Lite Geo
Textured Black, Clear



LIGHTING REPUBLIC

Dover Collection

The Dover Collection features a timeless and universal design that brings a sense of modernity to what would be considered a traditional lantern style of lighting.

The Dover Collection's large scale and Old Bronze finish elicit robust characteristics. This is contrasted by the airiness that is seen in the spaciousness within the shade. The delicateness from diffusion of the light becomes the focal point of this substantial collection.

Dover Lantern
4 Light, Clear



Dover Linear
4 Light, Clear

DOVER 3lt LINEAR



3 Light / Clear
LR.i02.73.009.CL



3 Light / Frosted
LR.i02.73.009.FR

DESCRIPTION

The Dover linear pendant is produced by hand in solid brass and incorporates quality tempered glass fixed panels. Available in either clear or a modernised frosted version.

PRODUCT DETAILS

Application
Indoor Pendant Light

Dimensions
H25 x W90 x L18cm

Materials
Shade: Tempered Glass
Fixture: Brass

Finishes
Shade: Clear or Frosted
Fixture: Old Bronze

Light Source
3 x E27 Max 9W LED

Rods
Max 200cm

NOTES

Item supplied with set of rods – 6 x 50cm and 4 x 25cm

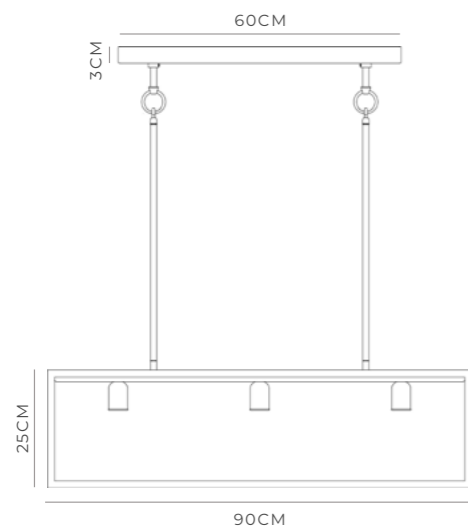

DOVER 4lt LINEAR



4 Light / Clear
LR.i02.73.008.CL

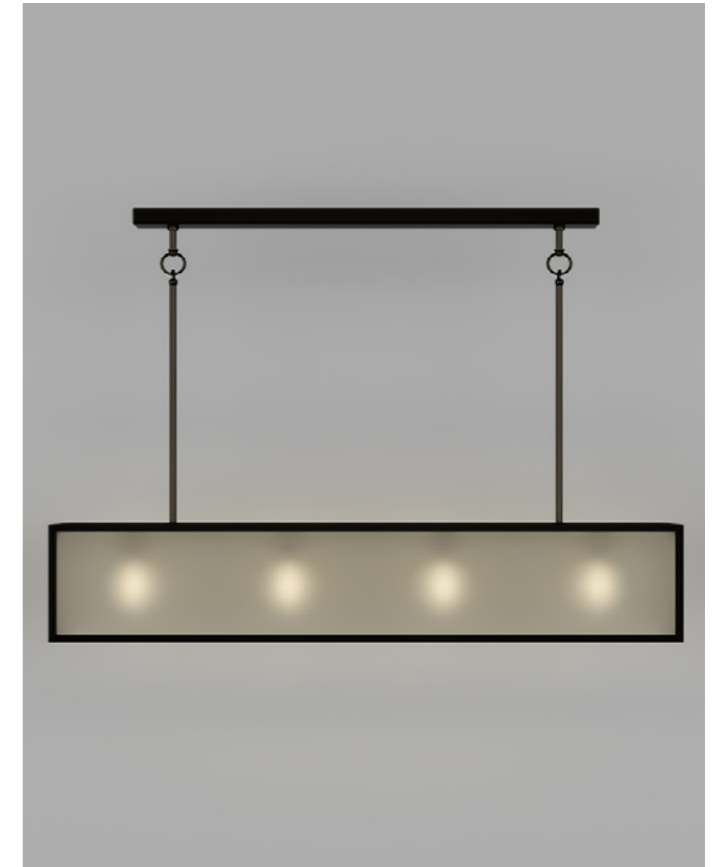

4 Light / Frosted
LR.i02.73.008 FR

DESCRIPTION

The Dover linear pendant is produced by hand in solid brass and incorporates quality tempered glass fixed panels. The impressive 120cm length creates an instant statement in any environment.

PRODUCT DETAILS

Application
Indoor Pendant Light

Dimensions
H25 x W120 x L18cm

Materials
Shade: Tempered Glass
Fixture: Brass

Finishes
Shade: Clear or Frosted
Fixture: Old Bronze

Light Source
4 x E27 Max 9W LED

Rods
Max 200cm

NOTES

Item supplied with set of rods – 6 x 50cm and 4 x 25cm

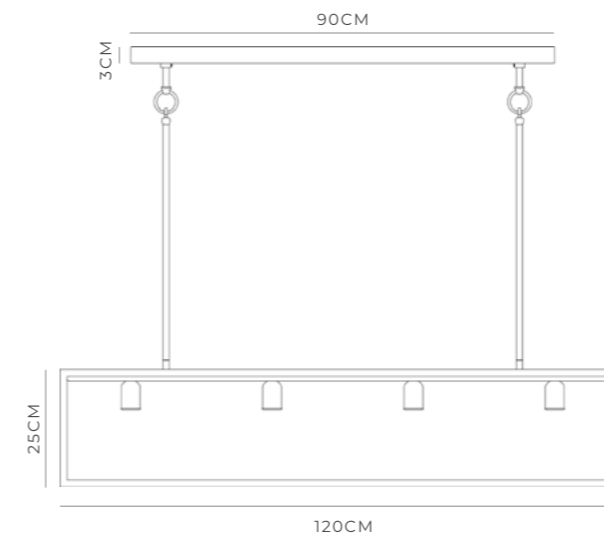

DOVER LANTERN



2 Light / Clear
LR.i03.73.002.CL



2 Light / Frosted
LR.i03.73.002 FR



4 Light / Clear
LR.i03.73.003.CL



4 Light / Frosted
LR.i03.73.003 FR

DESCRIPTION

The Dover Lantern Pendant Light was inspired by the pre-electric gas lights of towns in 19th century England and France. A beautiful addition to living areas, above kitchen islands or to the entrance of a home.

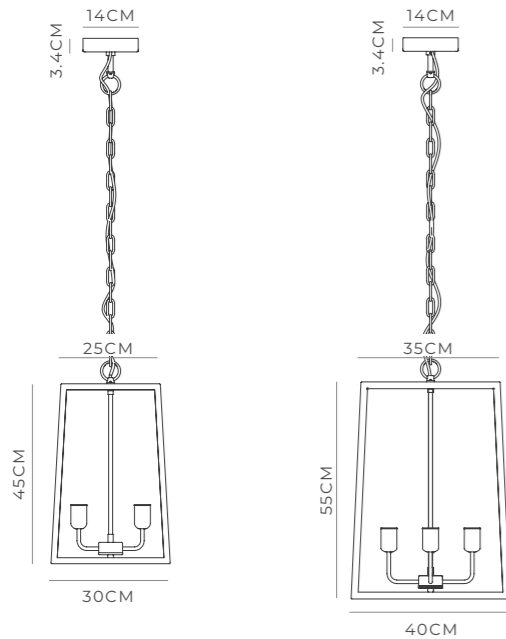

PRODUCT DETAILS

Application
Indoor Pendant Light

Dimensions
2 Light: H45 x Base W30
x Top W25 x L30cm
4 Light: H55 x Base W40
x Top W35 x L40cm

Materials
Shade: Tempered Glass
Fixture: Brass

Finishes
Shade: Clear or Frosted
Fixture: Old Bronze

Light Source
2 x E27 Max 9W LED
4 x E27 Max 9W LED

Chain
Max 200cm

NOTES

Fittings are all hand-crafted using traditional artisan techniques then skillfully aged to achieve the beautiful patina.



Dover Lantern
4 Light, Frosted



LIGHTING REPUBLIC

Bode Collection

The Bode Collection imbues a sense of strength and solidity balanced with a delicately elegant silhouette. Incorporating minimal elongated shapes and simple metal accents, this collection has a timeless allure with a modern twist. Crafted from glass and aluminium and presented with an Iron or Old Brass finish for a multi-faceted aesthetic.

The versatility of this wall light collection allows it to successfully blur the lines between traditional and contemporary settings.

BODE



Old Brass
LR.i01.85.OB



Iron
LR.i01.85.IRN

DESCRIPTION

Bode Wall Light utilises quality materials to create a fixture that has both a simple and effortless elegance combined with an enduring charm and longevity. A beautiful wall light that will comfortably sit in any interior setting from modern and minimalist to the more traditional aesthetic.

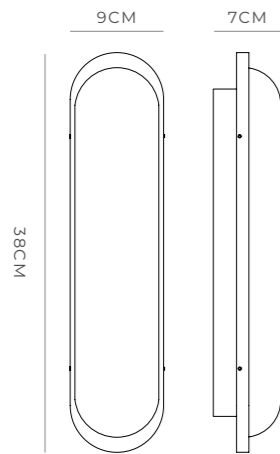

PRODUCT DETAILS

Application
Indoor Wall Light

Dimensions
H38 x W9 x L7cm

Materials
Shade: Glass
Fixture: Aluminium

Finishes
Shade: White
Fixture: Old Brass or Iron

Light Source
LED 10W 2700K

CRI
+90

Dimming
TRIAC

IP Rating
IP65

NOTES

The elongated white glass shade is encased by an aluminium frame available in either an Old Brass or Iron finish.



Bode
Old Brass



LIGHTING REPUBLIC

Shadow Collection

The Shadow Collection is a superb architectural addition to any contemporary space. The Shadow Wall Light adorns any space as it lights up celestially. The diffused light exerts a halo-like illumination from behind the flat shade to create soft and comfortable light.

For spaces that require minimal decor, the Shadow Wall Light is the perfect way to captivate with soft lighting. Like the Orb Collection, Shadow's glowing illumination lightens not just the room but the mood.

Shadow Ceiling & Mini
Satin White

SHADOW MINI

NEW

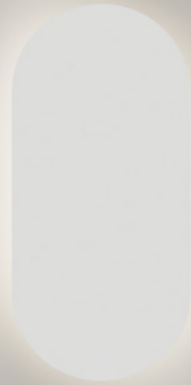

Mini
LR.i01.60.MINI.WH

DESCRIPTION

Shadow Mini Wall Light features a diffused light that exerts a halo-like illumination from behind the elongated flat shade to create soft and comfortable light. The Shadow Mini fitting can be installed horizontally or vertically to Shadow is the perfect way to captivate soft lighting within any space.

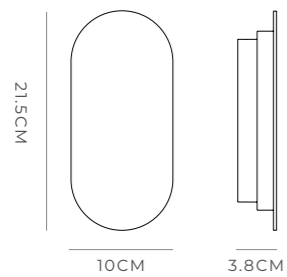

PRODUCT DETAILS

Application
Indoor Wall Light

Dimensions
H21.5 x W10 x D3.8cm

Materials
Aluminium

Finish
Satin White

Light Source
LED 6W 3000K

CRI
+90

Dimming
TRIAC

NOTES

The Shadow Mini Wall Light is dimmable with leading edge and trailing edge dimmers.

The Shadow fitting can also be installed on the ceiling to be used as an indirect light source that is close to ceiling.



Shadow Mini
Satin White



Shadow Long
Satin White

SHADOW LONG

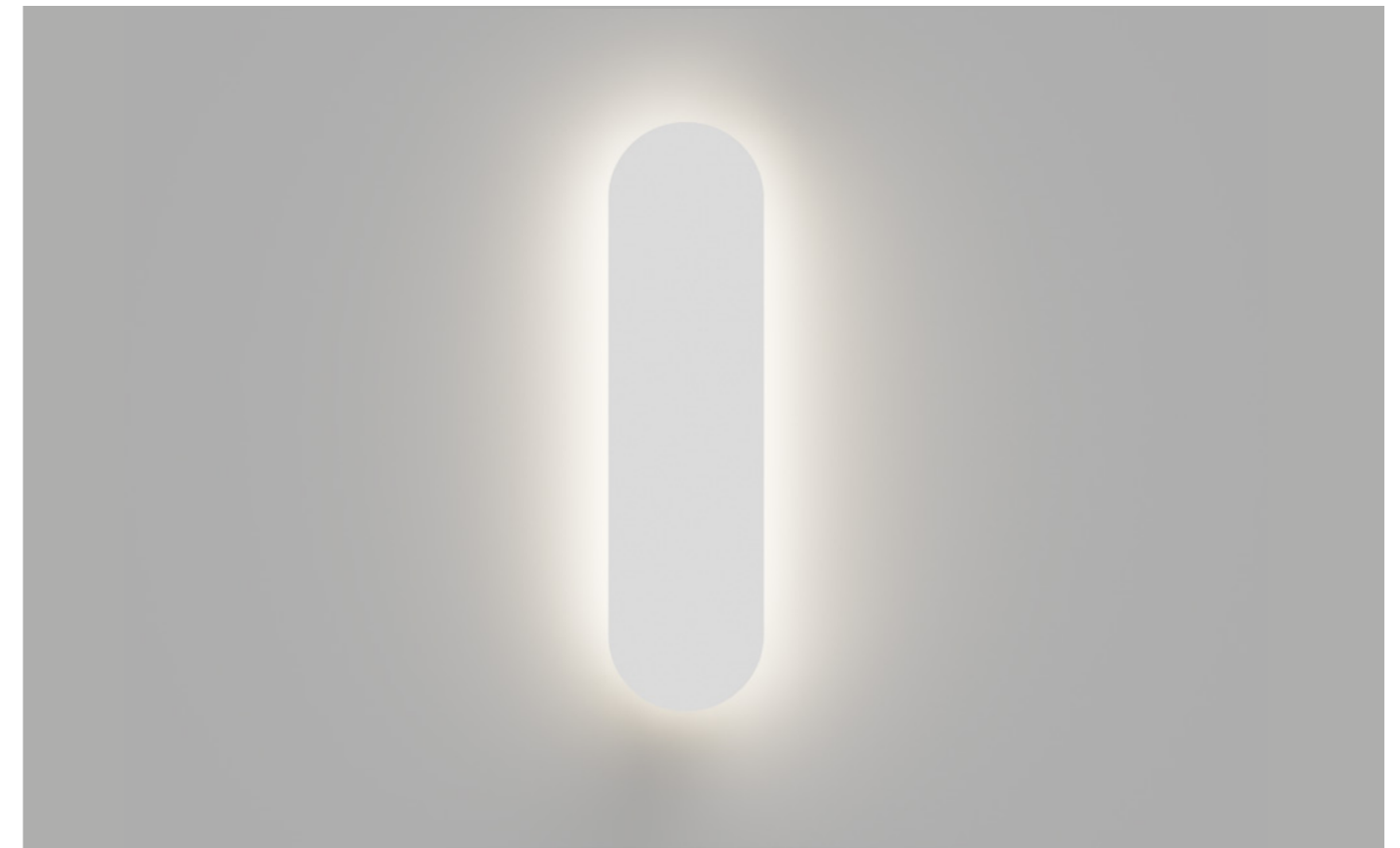

Long
LR.i01.60.LNG.WH

DESCRIPTION

Shadow Long Wall Light features a diffused light that exerts a halo-like illumination from behind the elongated flat shade to create soft and comfortable light. The Shadow Long fitting can be installed horizontally or vertically. Shadow is the perfect way to captivate soft lighting within any space.

PRODUCT DETAILS

Application
Indoor Wall Light

Dimensions
H38.5 x W10 x D3.8

Materials
Aluminium

Finish
Satin White

Light Source
LED 10W 3000K

CRI
+90

Dimming
TRIAC

NOTES

The Shadow Long Wall Light is dimmable with leading edge and trailing edge dimmers.

The Shadow fitting can also be installed on the ceiling to be used as an indirect light source that is close to ceiling.

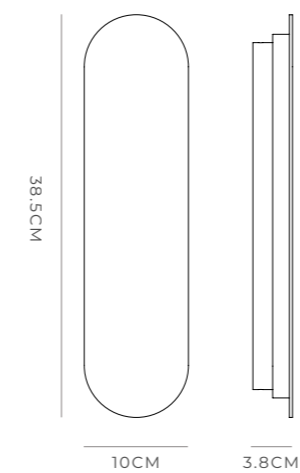



Shadow Long
Satin White

Parlour Curve
Iron, Clear

SHADOW

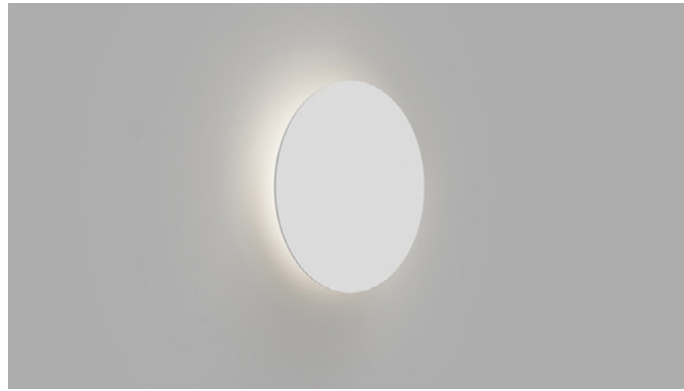

Medium | Wall
LR.i01.60.M.WH

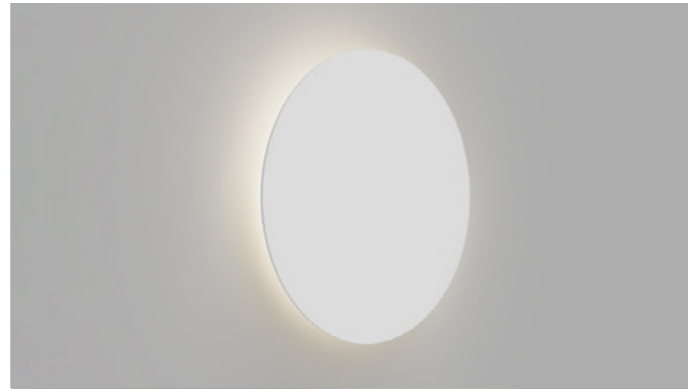

Large | Wall
LR.i01.60.L.WH

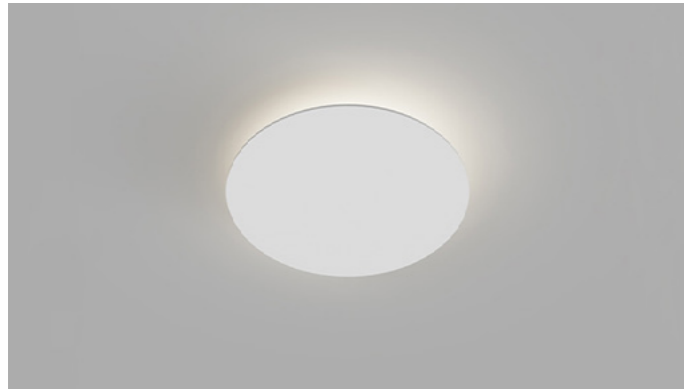

Medium | Ceiling
LR.i01.60.M.WH

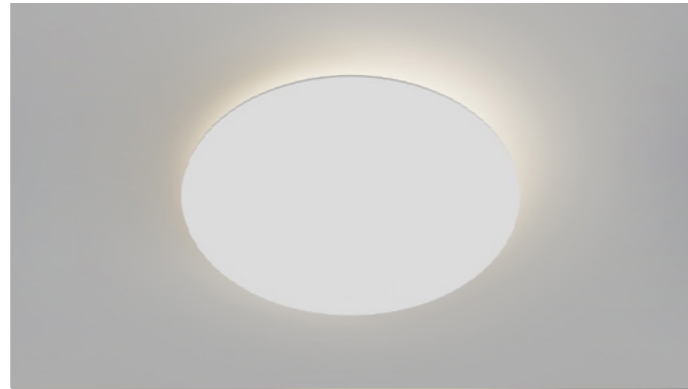

Large | Ceiling
LR.i01.60.L.WH

DESCRIPTION

Shadow Wall Light adorns any space as it lights up celestially. The diffused light exerts a halo-like illumination from behind the flat sphere shade to create soft and comfortable light. Shadow is the perfect way to captivate soft lighting within any space.

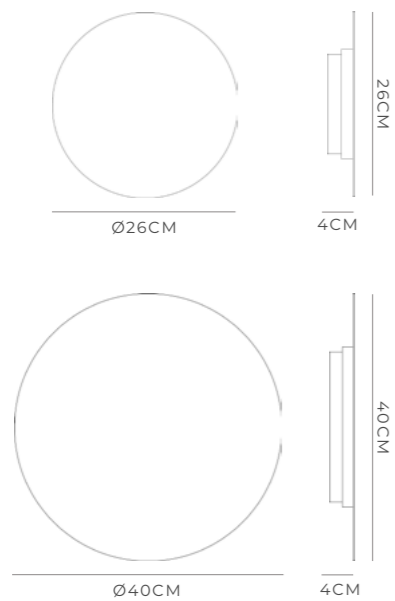

PRODUCT DETAILS

Application
Indoor Wall Light or Ceiling Light

Dimensions
Medium: Ø26cm
Large: Ø40cm

Materials
Aluminium

Finish
White

Light Source
LED 10W 3000K

CRI
+90

Dimming
TRIAC

NOTES

The Shadow Wall Light is dimmable with leading edge and trailing edge dimmers.

The Shadow fitting can also be installed on the ceiling to be used as an indirect light source that is close to ceiling.



Shadow
Medium & Large

Orb Collection

The Orb Collection emphasises the curvature and smoothness of simple spheres. Contemporary and minimal in the collection's design, this series is perfect to bring softness and tranquility to any room's ambience.

Minimal, not only in its form but its style, the glowing illumination lightens not just the room but the mood. The Orb Collection allows for endless possibilities whether it's a single impactful Orb or a cluster to create a statement interior wall composition.



Orb Mirror
Medium, White

Orb Mirror
Medium, White

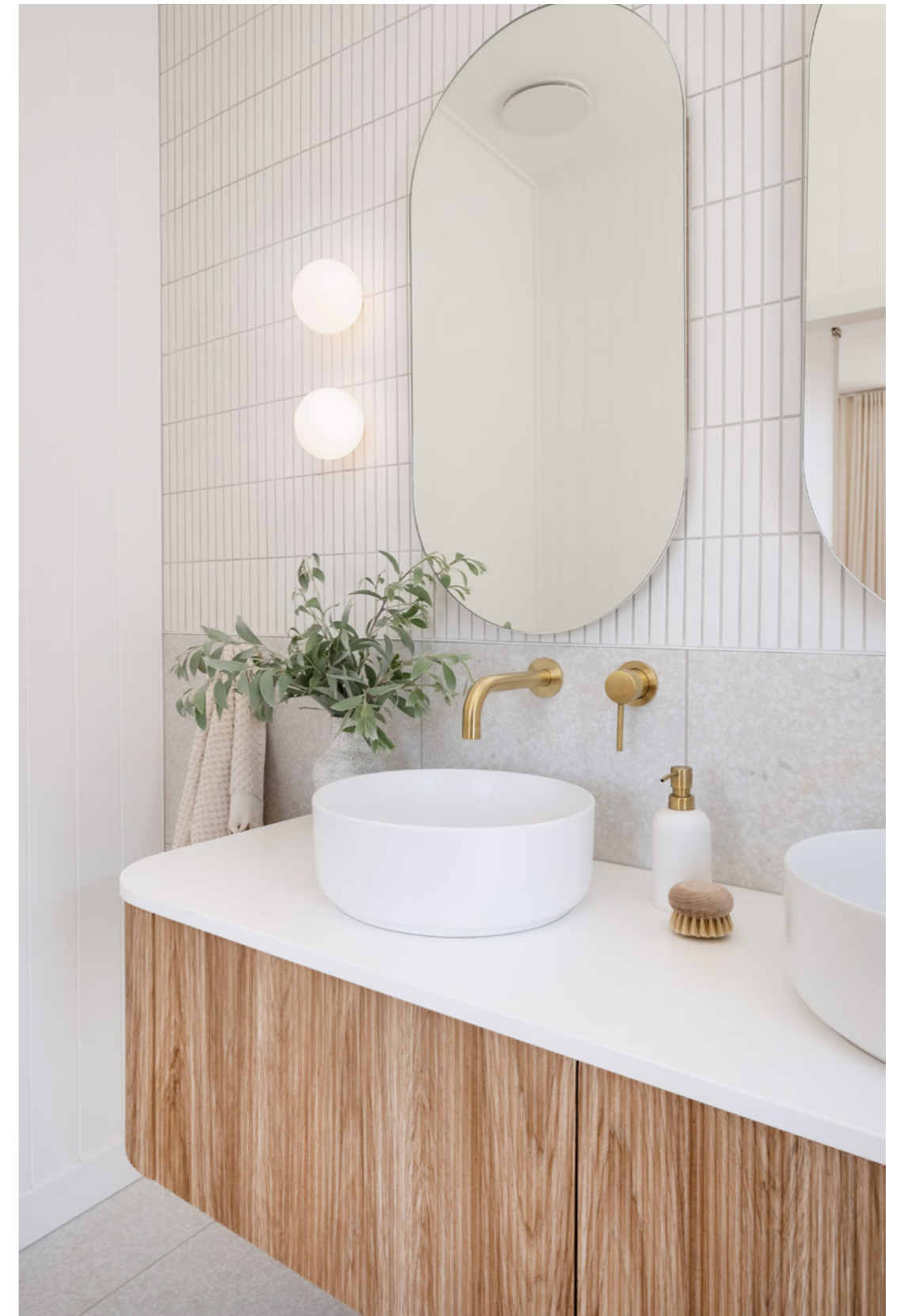

Orb Mirror
Medium, White

ORB MIRROR

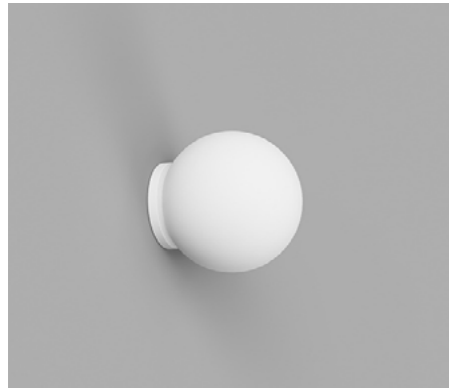

Small / White
LR.i01.54M.WH +LR.A03.S.WH

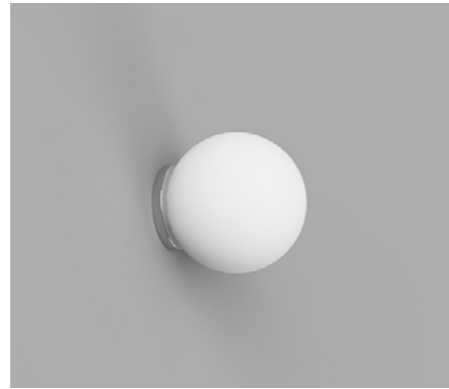

Small / Chrome
LR.i01.54M.CH +LR.A03.S.WH

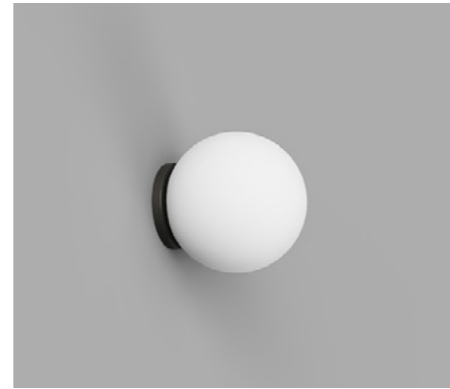

Small / Dark Bronze
LR.i01.54M.DB +LR.A03.S.WH

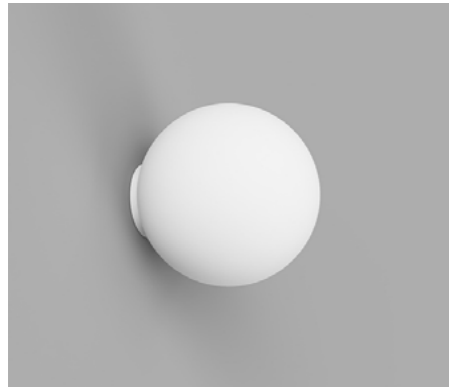

Medium / White
LR.i01.54M.WH +LR.A03.M.WH

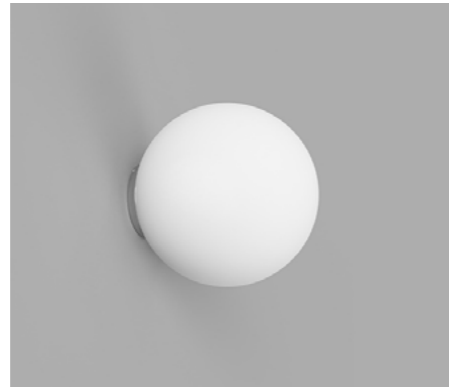

Medium / Chrome
LR.i01.54M.CH +LR.A03.M.WH

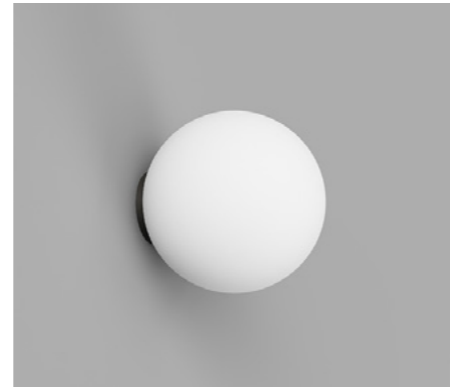

Medium / Dark Bronze
LR.i01.54M.DB +LR.A03.M.WH

DESCRIPTION

Simultaneously contemporary and classic, the Orb Mirror Wall Light is versatile enough to compliment any space. Minimal, not only in its form but its style, the glowing illumination lightens not just the room but the mood. With its sphere, the white glass softens and diffuses the light. Suitable to use in bathrooms.

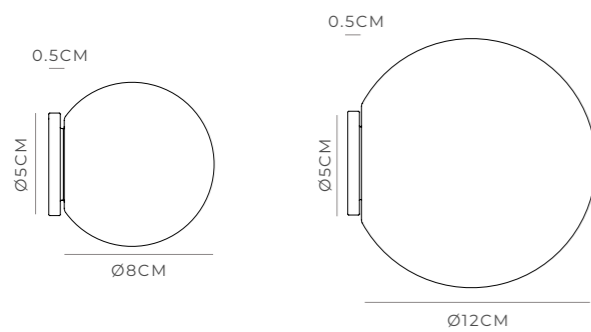

PRODUCT DETAILS

Application
Indoor Wall Light

Dimensions
Shade: Ø8cm (Small) or
Ø12cm (Medium)
Fixture: Ø5 x L0.5cm

Materials
Shade: Glass
Fixture: Aluminium

Finishes
Shade: Satin White
Fixture: White, Chrome
or Dark Bronze

Light Source
G9 Max 3W LED

IP Rating
IP44

NOTES

The Orb mirror has a micro base and as such the electrical connection will need to be located in the wall behind the fitting.



Orb Mirror
Medium, White

ORB SHORT ARM

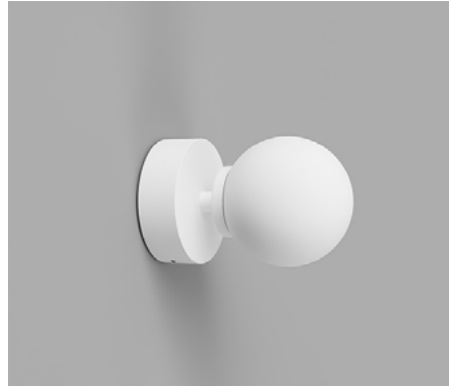

Small / White
LR.i01.54A.WH +LR.A03.S.WH

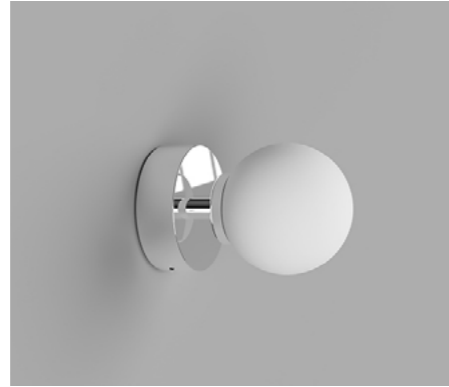

Small / Chrome
LR.i01.54M.CH +LR.A03.S.WH

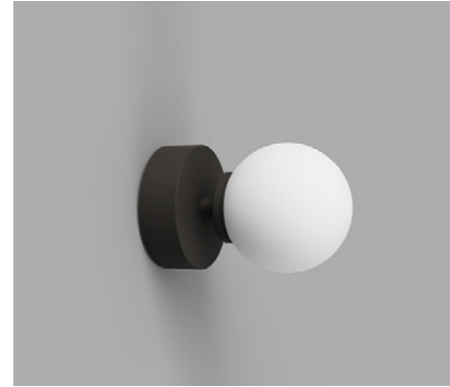

Small / Dark Bronze
LR.i01.54A.DB +LR.A03.S.WH

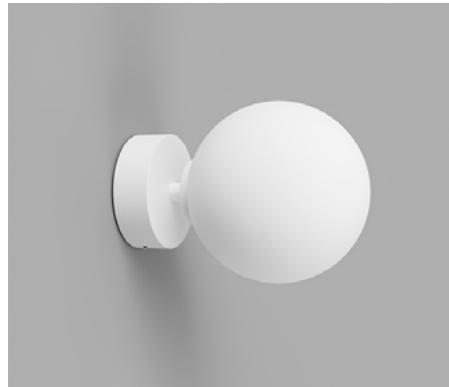

Medium / White
LR.i01.54A.WH +LR.A03.M.WH

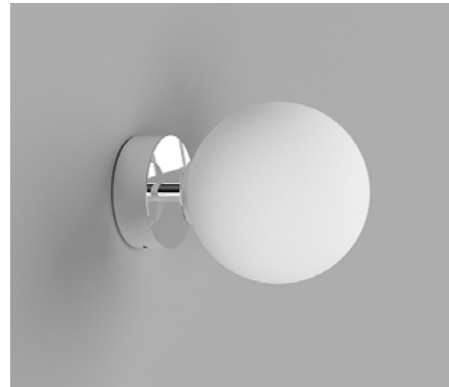

Medium / Chrome
LR.i01.54A.CH +LR.A03.M.WH

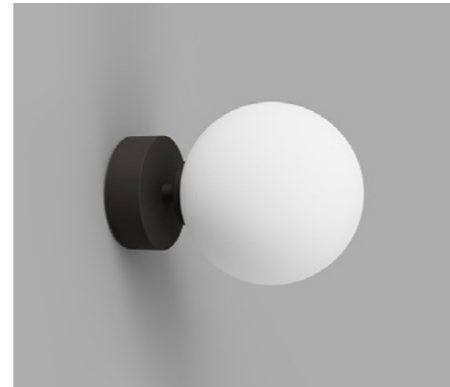

Medium / Dark Bronze
LR.i01.54A.DB +LR.A03.M.WH

DESCRIPTION

This variation of the Orb features a rounded base that protrudes from the wall in comparison to the Mirror Wall variation which sits flush onto the wall. Minimal in not only its form but style, the glowing sphere lightens not just the room but the mood. Suitable to use in bathrooms.

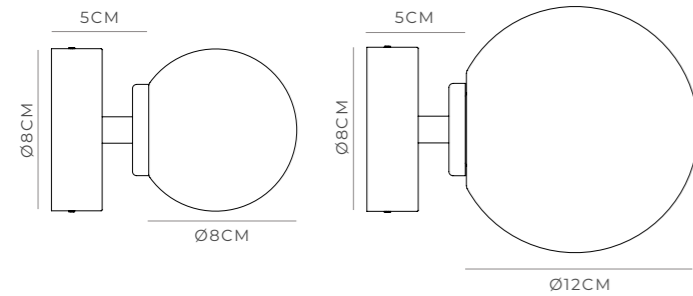

PRODUCT DETAILS

Application
Indoor Wall Light

Dimensions
Shade: Ø8cm (Small) or
Ø12cm (Medium)
Fixture: Ø8 x L5cm

Materials
Shade: Glass
Fixture: Aluminium

Finishes
Shade: Satin White
Fixture: White, Chrome
or Dark Bronze

Light Source
G9 Max 3W LED

IP Rating
IP44

NOTES

The Orb Short Arm Wall light can also be used as a ceiling light to add ambience to small bathrooms and nooks.



Orb Short Arm
Medium, White



Orb Long Arm
Medium, White

ORB LONG ARM



Small / White
LR.i01.54B.WH + LR.A03.S.WH

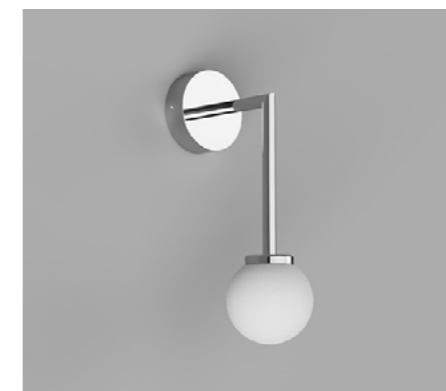

Small / Chrome
LR.i01.54B.CH + LR.A03.S.WH



Small / Dark Bronze
LR.i01.54B.DB + LR.A03.S.WH

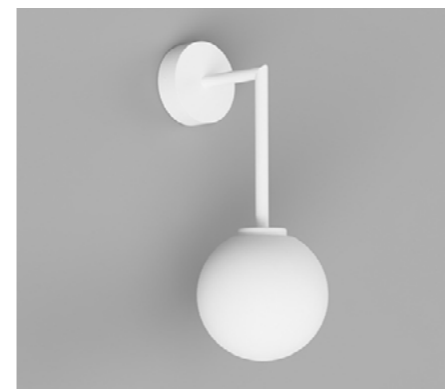

Medium / White
LR.i01.54B.WH + LR.A03.M.WH

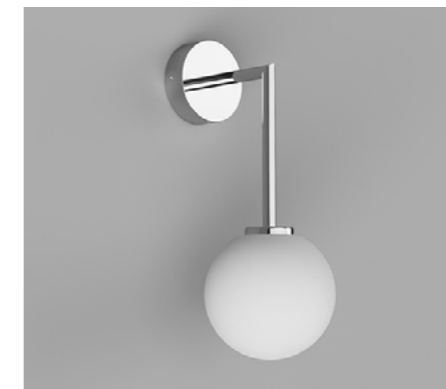

Medium / Chrome
LR.i01.54B.CH + LR.A03.M.WH



Medium / Dark Bronze
LR.i01.54b.DB + LR.A03.M.WH

DESCRIPTION

With its long arm, this variation from the Orb collection accentuates its placement within a space. It makes a statement yet still allows the focus to stay on the smoothness of the sphere. Its proportions showcase the harmonious balance between its diametrical forms. Suitable to use in bathrooms.

PRODUCT DETAILS

Application
Indoor Wall Light

Dimensions
Shade: Ø8cm (Small) or Ø12cm (Medium)
Fixture: H19.5 x Ø8 x L12.5cm

Materials
Shade: Glass
Fixture: Aluminium

Finishes
Shade: Satin White
Fixture: White, Chrome or Dark Bronze

Light Source
G9 Max 3W LED

IP Rating
IP44

NOTES

The long arm allows you to extend the light source placement which is especially useful when replacing existing wall lights. It can be used either up or downward facing.

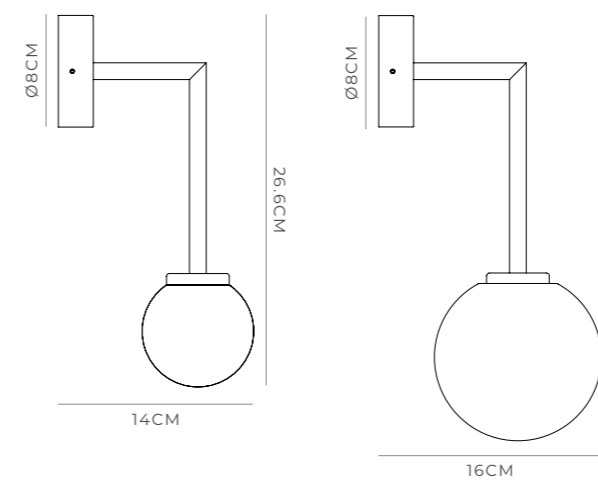

Orb Sur Collection

The Orb Sur collection is set to command a place in the arena of classics. This collection of wall lights has the quintessential characteristics of the style and quality expected from a timeless and enduring design. Exuding poise and an understated charm, the metal frame encircles the perfect glass orb with variations in size and finish adding the necessary versatility required of such a multi-functional light.

A beautiful collection that carries an aura of sophistication and ease, lending its allure to any interior environment in which it is placed.



Orb Sur
Small, White

Orb Sur
Small, White



Orb Sur
Small, White

ORB SUR

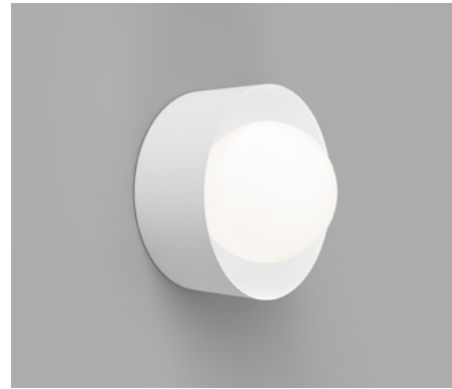

Small / White
LR.i01.54e.M.WH
LR.i01.54M.WH + LR.A03.S.WH



Small / Old Brass
LR.i01.54e.M.OB
+ LR.i01.54M.WH + LR.A03.S.WH



Small / Iron
LR.i01.54e.M.IRN
+ LR.i01.54M.DB + LR.A03.S.WH

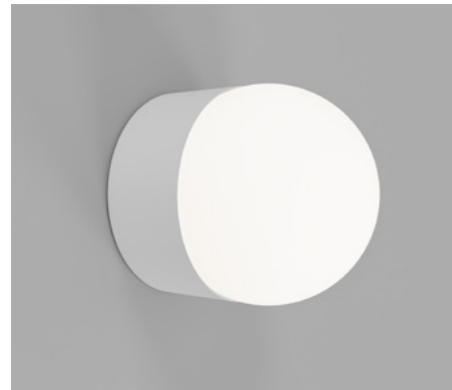

Medium / White
LR.i01.54e.M.WH
LR.i01.54M.WH + LR.A03.M.WH

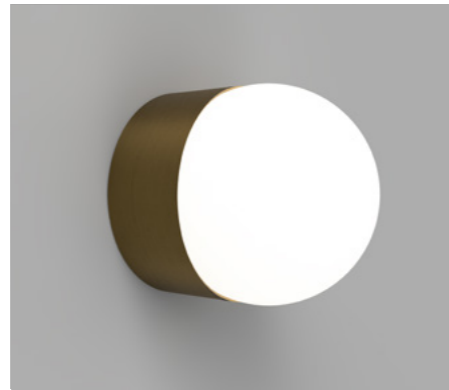

Medium / Old Brass
LR.i01.54e.M.OB
+ LR.i01.54M.WH + LR.A03.M.WH



Medium / Iron
LR.i01.54e.M.IRN
+ LR.i01.54M.DB + LR.A03.M.WH

DESCRIPTION

Orb Sur Wall Light takes the classic glass sphere of the Orb collection and incorporates an aluminium frame, adding an extra element of depth to this most versatile wall light. The perfect sphere of opal glass emits a soft and diffused light and will sit comfortably in any interior setting.

PRODUCT DETAILS

Application
Indoor Wall Light

Dimensions
Shade: Ø8cm (Small) or
Ø12cm (Medium)
Fixture: Ø12cm x L5cm

Materials
Shade: Glass
Fixture: Aluminium (White)
Brass (Old Brass & Iron)

Finishes
Shade: White
Fixture: White, Old Brass
or Iron

Light Source
G9 Max 3W LED

IP Rating
IP44

NOTES

Minimal and versatile enough to be fitted with an assortment of accessories. The Orb Collection is modular with a wide range of possibilities.

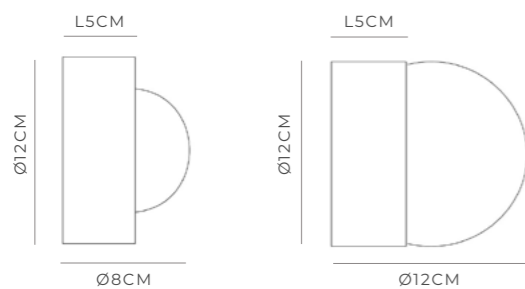

Orb Sur
Small, Old Brass



Orb Sur Mini
Iron

ORB SUR MINI



White
LR.i01.54e.S.WH
+ LR.i01.54M.WH + LR.A03.S.WH



Old Brass
LR.i01.54e.S.OB
+ LR.i01.54M.WH + LR.A03.S.WH



Iron
LR.i01.54e.S.IRN
+ LR.i01.54M.DB + LR.A03.S.WH

DESCRIPTION

Orb Sur Mini Wall Light is miniature in form and exudes a contemporary and minimal aesthetic. Taking the classic glass sphere of the Orb Collection, it incorporates a sleek aluminium frame. The perfect sphere of opal glass emits a soft and diffused light, ideal for any interior that requires discreet lighting.

PRODUCT DETAILS

Application

Indoor Wall Light

Dimensions

Shade: Ø8cm (Small) or
Ø12cm (Medium)
Fixture: Ø12cm x L5cm

Materials

Shade: Glass
Fixture: Aluminium (White)
Brass (Old Brass & Iron)

Finishes

Shade: White
Fixture: White, Old Brass
or Iron

Light Source

G9 Max 3W LED

IP Rating

IP44

NOTES

Minimal and versatile enough to be fitted with an assortment of accessories. The Orb Collection is modular with a wide range of possibilities.

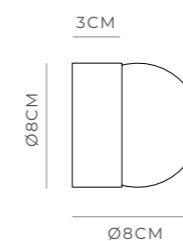

Orb Dome Collection

Expanding on the timeless Orb Collection is the Orb Dome, where a half-sphere shade takes centre stage. The Dome evokes a slightly more impactful appearance. Notably in size, but also in the way in which the form of the Dome presents a contrasting buoyant character.

While the emphasis remains on the curvature and smoothness of simple spheres, the Orb Dome collection is a perfect way to incorporate statement pieces to any interior while maintaining a contemporary and minimal flair.





Orb Max
Extra Large, Textured Black

Orb Dome Mirror
White

ORB DOME MIRROR

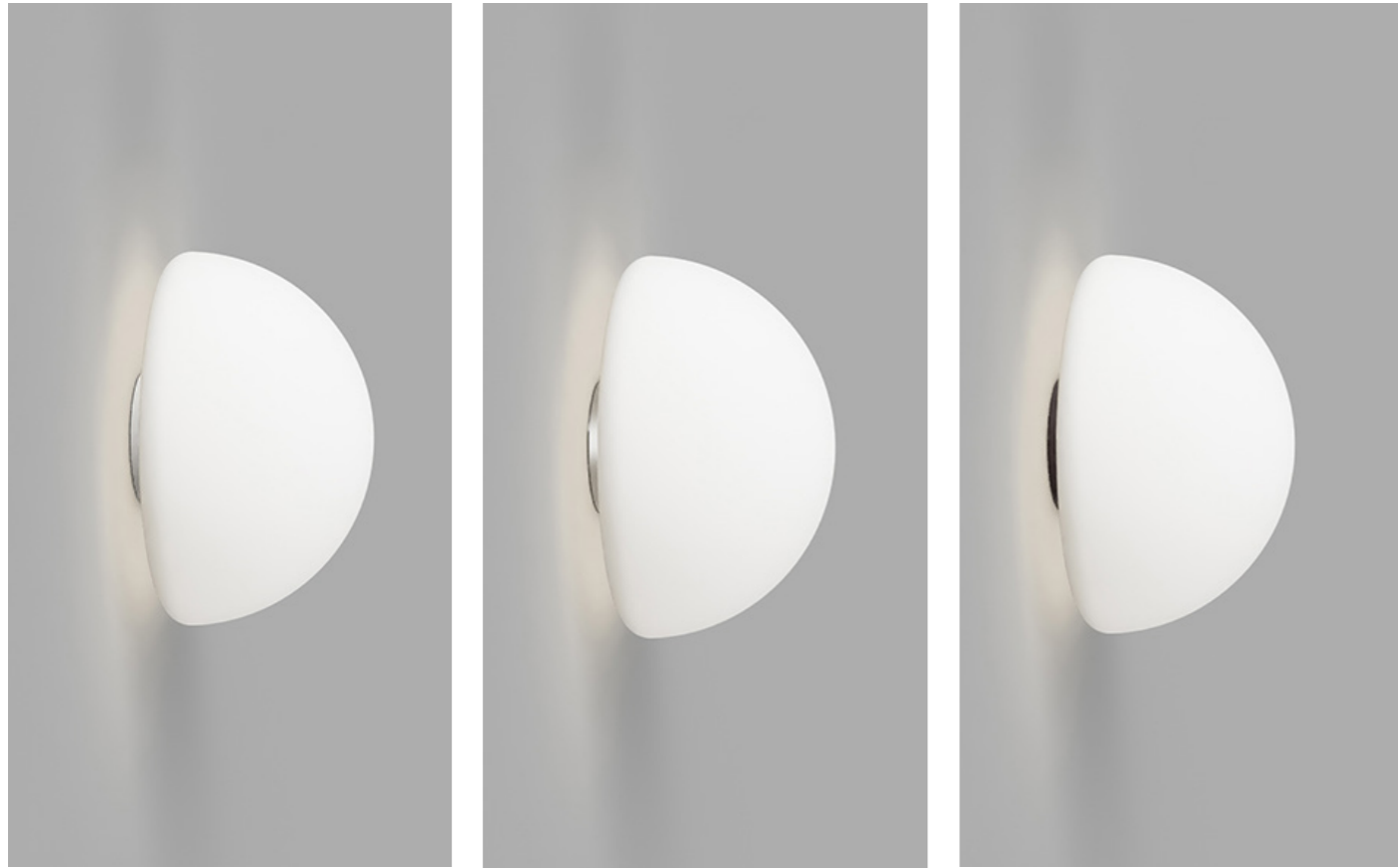

White
LR.i01.54M.WH + LR.A03.DM.WH

Chrome
LR.i01.54M.CH + LR.A03.DM.WH

Dark Bronze
LR.i01.54M.DB + LR.A03.DM.WH

DESCRIPTION

The Orb Dome Mirror Wall Light features a half-sphere shade and is versatile enough to complement any space. Minimal, not only in its form but its style, the glowing illumination lightens not just the room but the mood. With its dome, the white glass softens and diffuses the light beautifully. Suitable to use in bathrooms.

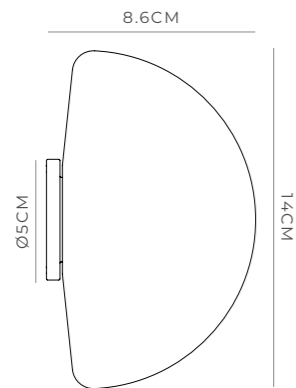

PRODUCT DETAILS

Application
Indoor Wall Light

Dimensions
Shade: H14 x W14 x L8.6cm
Fixture: Ø5 x L0.5cm

Materials
Shade: Glass
Fixture: Aluminium

Finishes
Shade: Satin White
Fixture: White, Chrome or Dark Bronze

Light Source
G9 Max 3W LED

IP Rating
IP44

NOTES

The Orb Dome Mirror allows for endless possibilities whether its one single impactful Orb Dome or a cluster to create a statement interior wall composition.

ORB DOME SHORT ARM

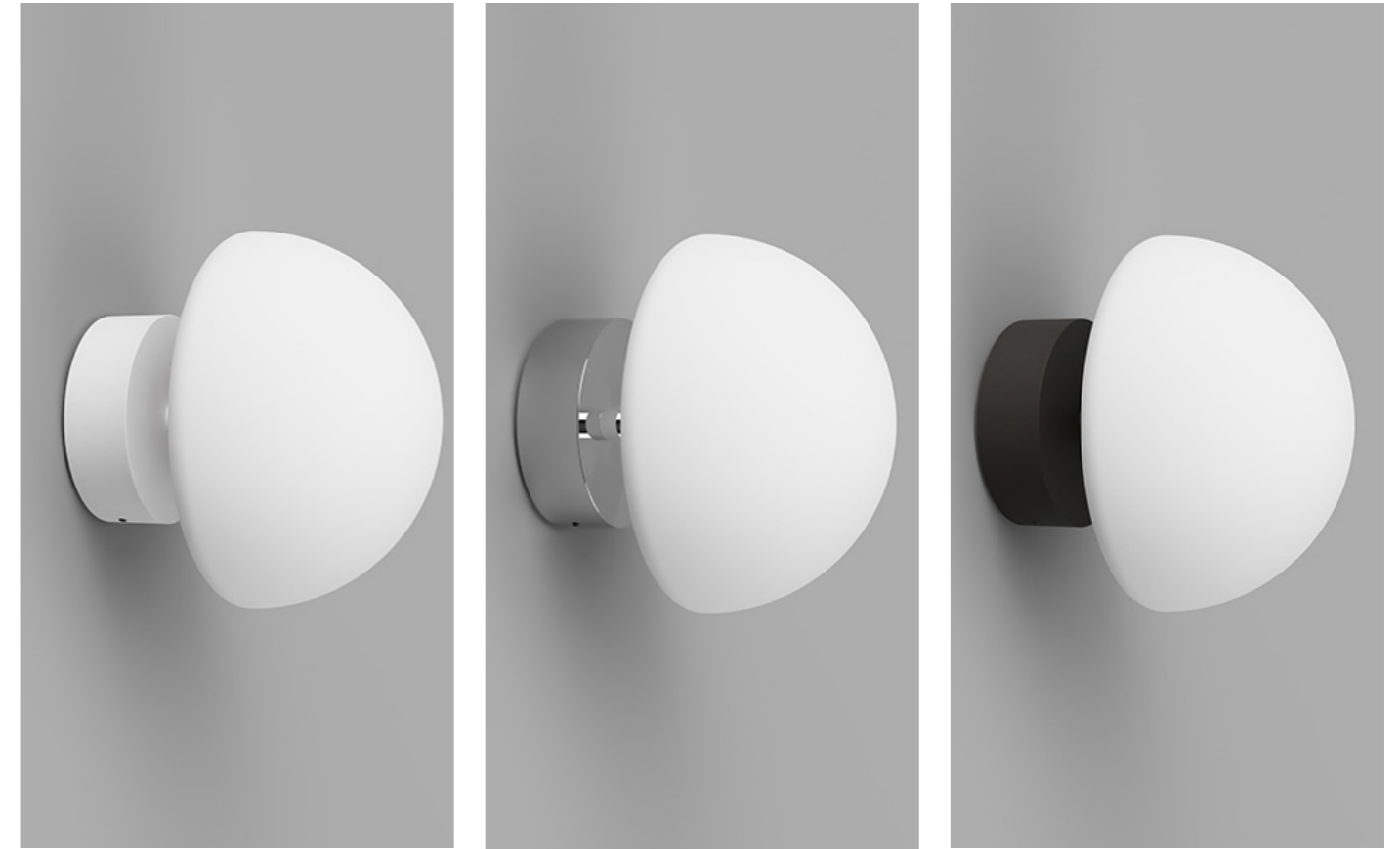

White
LR.i01.54A.WH + LR.A03.DM.WH

Chrome
LR.i01.54A.CH + LR.A03.DM.WH

Dark Bronze
LR.i01.54A.DB + LR.A03.DM.WH

DESCRIPTION

The Orb Dome Short Arm Wall Light features a rounded base that protrudes from the wall in comparison to the Mirror Wall variation which sits flush onto the wall. Minimal in not only its form but style, the glowing illumination lightens not just the room but the mood. Suitable to use in bathrooms.

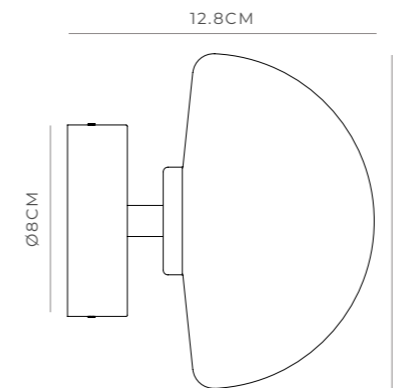

PRODUCT DETAILS

Application
Indoor Wall Light

Dimensions
Shade: H14 x W14 x L12.8cm
Fixture: Ø8 x L5cm

Materials
Shade: Glass
Fixture: Aluminium

Finishes
Shade: Satin White
Fixture: White, Chrome or Dark Bronze

Light Source
G9 Max 3W LED

IP Rating
IP44

NOTES

Versatile enough to compliment to any space, the Orb Dome Short Arm is simultaneously contemporary and classic.

ORB DOME LONG ARM



White
LR.i01.54B.WH + LR.A03.DM.WH



Chrome
LR.i01.54B.CH + LR.A03.DM.WH



Dark Bronze
LR.i01.54B.DB + LR.A03.DM.WH

DESCRIPTION

With its long arm, this variation from the Orb collection features a half sphere shade. It makes a statement yet still allows the focus to stay on the smoothness of the dome. Its proportions showcase the harmonious balance between its diametrical forms. Suitable to use in bathrooms.

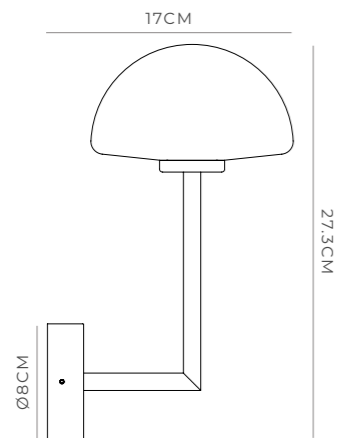

PRODUCT DETAILS

Application
Indoor Wall Light

Dimensions
Shade: H14 x W14 x L8.6cm
Fixture: H19.5 x Ø8 x L12.5cm

Materials
Shade: Glass
Fixture: Aluminium

Finishes
Shade: Satin White
Fixture: White, Chrome or Dark Bronze

Light Source
G9 Max 3W LED

IP Rating
IP44

NOTES

The long arm transforms the Orb Dome from being an understated fixture to a statement piece by accentuating its craftsmanship and finish.

Can be installed with diffuser up or down facing.



Orb Dome Long Arm
White

LIGHTING REPUBLIC

Lumina Collection



Lumina
Textured Black

The Lumina Ceiling Light exemplifies modern elegance with its sleek profile and minimalist design. Each component is carefully designed to enhance a refined, sophisticated aesthetic. The Lumina collection is highly versatile, suitable for a variety of interior and exterior settings thanks to its IP65 rating, ensuring durability without sacrificing style.

Marrying form and function, the Lumina Ceiling Light effortlessly combines contemporary design with practical usability. Its minimalist style brings a touch of sophistication to any space, whether it's enhancing the ambiance of a living room or providing reliable illumination outdoors.

LUMINA



Textured Black
LR.i04.16.S.BL



Textured White
LR.i04.16.S.WH

DESCRIPTION

Lumina Ceiling Light embodies modern elegance with its sleek profile and minimalist aesthetic. This contemporary range is designed for versatility, and suitable for indoor and outdoor setting with its IP65 rating.

Lumina seamlessly combines design and durability, enhancing any environment with its sophisticated presence.

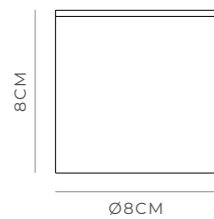

PRODUCT DETAILS

Application
Indoor or Outdoor
Ceiling Light

Dimensions
H8 x Ø8cm

Materials
Aluminium

Finishes
Textured Black or
Textured White

Light Source
GU10 Max 8W

IP-Rating
IP65

NOTES

Whether adorning your living room or enhancing your outdoor patio, Lumina delivers both style and functionality in a seamless package.



Lumina
Textured White



LIGHTING REPUBLIC

Orb Ledge Collection

The Orb Ledge collection is as enchanting as it is robust and as elegant as it is striking. The compact brass shelf and the flawless orb of glass strike the perfect balance between gravitas and grace. Smoothly contoured with a solidity at its core, it is a superlative contemporary piece.

Comfortable in any outdoor situation, it emits a welcoming wash of light that reaches out from its white glass shade. A truly versatile design, the Orb Ledge collection has a captivating charisma and timeless appeal.

Orb Ledge
Medium, Old Bronze

ORB LEDGE



Small / Old Bronze
LR.E01.54.DB + LR.A03.S.WH



Medium / Old Bronze
LR.E01.54.DB + LR.A03.M.WH

DESCRIPTION

Orb Ledge Wall Light is a striking addition to the iconic Orb collection. A versatile light that allows for an up or down configuration where the perfect white glass sphere is either perched above or hung below a simple ledge. A solid contemporary fixture with an Old Bronze finish that displays all the attributes of classic and enduring design.

PRODUCT DETAILS

Application

Indoor Wall or Outdoor Wall Light

Dimensions

Small: H10 x W9 x L14cm
Medium: H14 x W12 x L15cm

Materials

Shade: Glass
Fixture: Brass

Finishes

Shade: White
Fixture: Old Bronze

Light Source

G9 Max 3W LED

IP Rating

IP44

NOTES

Available in a small and medium size and with an IP44 rating, making it ideal for outdoor and bathroom use.

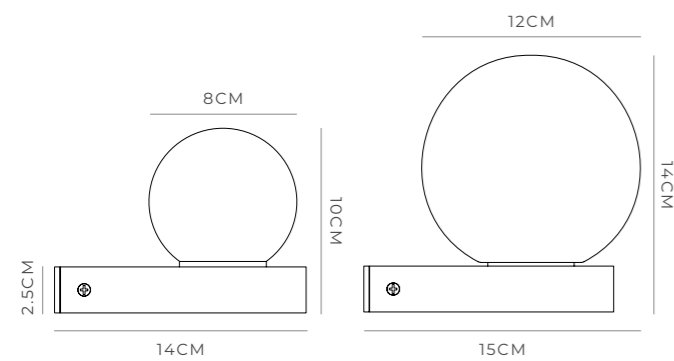

Orb Ledge
Small & Medium
Old Bronze

LIGHTING REPUBLIC

Tuva Collection



Tuva
Round, Clear

The Tuva collection draws inspiration from history. A vintage lantern reimagined for the modern day, with effortless beauty and functionality brought to the fore. Smooth curved lines bound with strong angular edges, simple shapes are at the core of this collection's abiding appeal and attraction. Crafted from solid brass, it has multiple glass options for added variety of style.

A sleek design with a timeless silhouette, the Tuva collection welcomes us to an elevated level of outdoor charm and sophistication.

TUVA



Round / Clear
LR.E01.77.ST + LR.E01.77.RND.CL



Round / Gloss White
LR.E01.77.ST + LR.E01.77.RND.WH



Flat / Clear
LR.E01.77.ST + LR.E01.77.FLT.CL



Flat / Gloss White
LR.E01.77.ST + LR.E01.77.FLT.WH

DESCRIPTION

Tuva Wall Light is a very modern take on a vintage marine style lantern light. With its solid brass fixture from which the glass shade hangs, this contemporary wall light provides a perfectly proportioned and impressive feature.

PRODUCT DETAILS

Application
Indoor and Outdoor Wall Light

Dimensions
H28 x W13 x L14cm

Materials
Shade: Glass
Fixture: Brass

Finishes
Shade: Clear or White
Fixture: Old Bronze

Light Source
E27 Max 9W LED

IP Rating
IP44

NOTES

With options for clear or white glass and a round or flat shade, this versatile wall light is almost industrial in style yet carries an air of understated refinement.

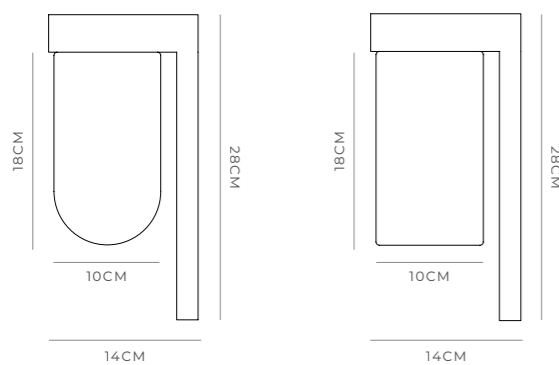

Tuva
Round, White

LIGHTING REPUBLIC

Lille Collection



Lille
Small, Clear

The Lille Collection was inspired by traditional wall and pendant lights but puts a modern spin on this recognisable design. A contemporary interpretation of boxed lighting, the Lille collection is bold yet ambrosial with an Industrial allure.

The archetypal design of this collection leans towards a contemporary motif as seen by the Industrial-style brass finish. The bold lines seen in this design have been counteracted by soft curves. Strong and sturdy in its construction yet refined and versatile for a variety of spaces.

LILLE



Small / Clear
LR.E01.73.004.CL



Small / Frosted
LR.E01.73.004.FR



Medium / Clear
LR.E01.73.005.CL



Medium / Frosted
LR.E01.73.005.FR

DESCRIPTION

The Lille Wall Light is a modern interpretation of a classic wall light. Its archetypal design leans towards a contemporary motif as seen by the Industrial-style brass finish.

PRODUCT DETAILS

Application
Indoor and Outdoor
Wall Light

Dimensions
Small: H35 x W13 x L13cm
Medium: H35 x W17 x L13cm

Materials
Shade: Tempered Glass
Fixture: Brass

Finishes
Shade: Clear or Frosted
Fixture: Old Bronze

Light Source
E27 Max 9W LED

IP Rating
IP44

NOTES

Strong and sturdy in its construction yet refined and versatile for a variety of interiors.

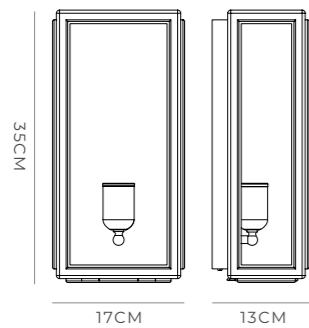
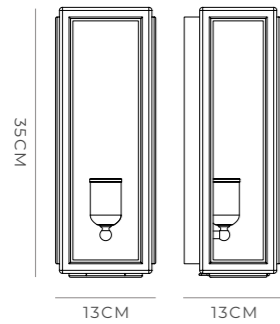

Lille
Medium, Clear



Lille 2lt
Clear

LILLE 2lt



Clear
LR.i04.73.006.CL

DESCRIPTION

The Lille 2Lt Wall/Ceiling Light is a modern interpretation of a classic box light. Its archetypal design leans towards a contemporary motif as seen by the Industrial-style brass finish.

PRODUCT DETAILS

Application
Indoor Wall
or Ceiling Light

Dimensions
H30 x W30 x L13cm

Materials
Shade: Tempered Glass
Fixture: Brass

Finishes
Shade: Clear
Fixture: Old Bronze

Light Source
2 x E27 Max 9W LED

NOTES

Lamp holders can be easily relocated to be side-by-side for wall light applications

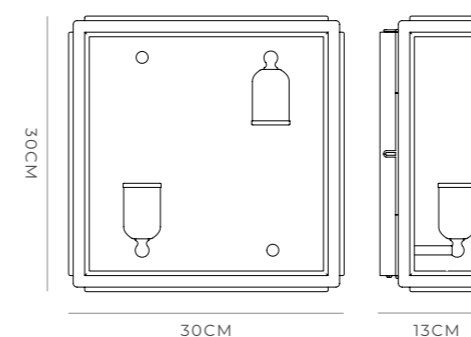

Ceiling Canopy Collection

When we look for solutions to customise elements of our spaces, sometimes all it takes are some pretty smart accessories.

Elevate your lighting design with our selection of ceiling canopies, expertly crafted to enhance the functionality and aesthetics of your pendant lights. These versatile fixtures serve as the foundation for your lighting arrangements, providing essential support while adding a touch of elegance to your space.

CEILING CANOPIES



Single Canopy
LR.A02.SCC.WH

PRODUCT DETAILS

A sleek and versatile solution to elevate your lighting setup. Designed with simplicity and functionality in mind, this canopy offers a minimalist aesthetic while providing essential support for your pendant light.

Application
Indoor Ceiling Canopy

Materials
Aluminium

Dimensions
H4 x W6CM

Finish
Satin White

Maximum Load
2.5kg

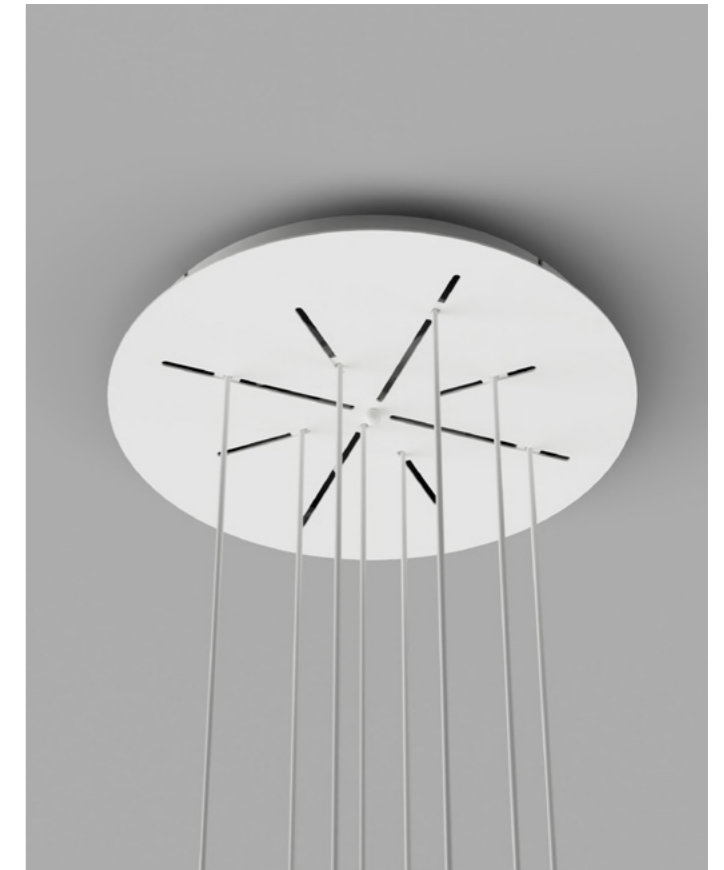
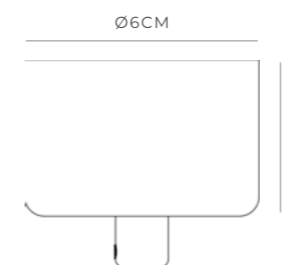

Ceiling Plate
LR.A02.CP.WH

PRODUCT DETAILS

The plate can accommodate up to 8 pendant lights and the maximum fixture weight should not exceed 25kg. Ensure sufficient support is provided in the ceiling for the plate and pendants.

Application
Indoor Ceiling Canopy

Materials
Steel

Dimensions
H4 x W50CM

Finish
Satin White

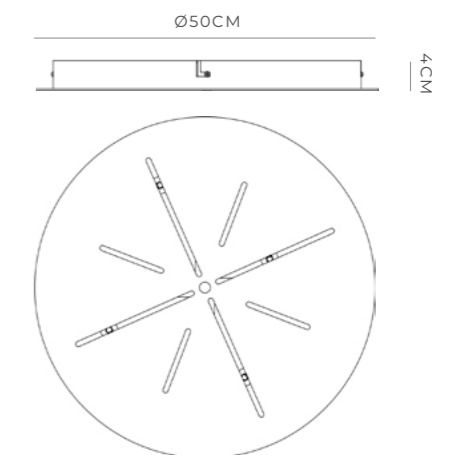

RECESSED CANOPY

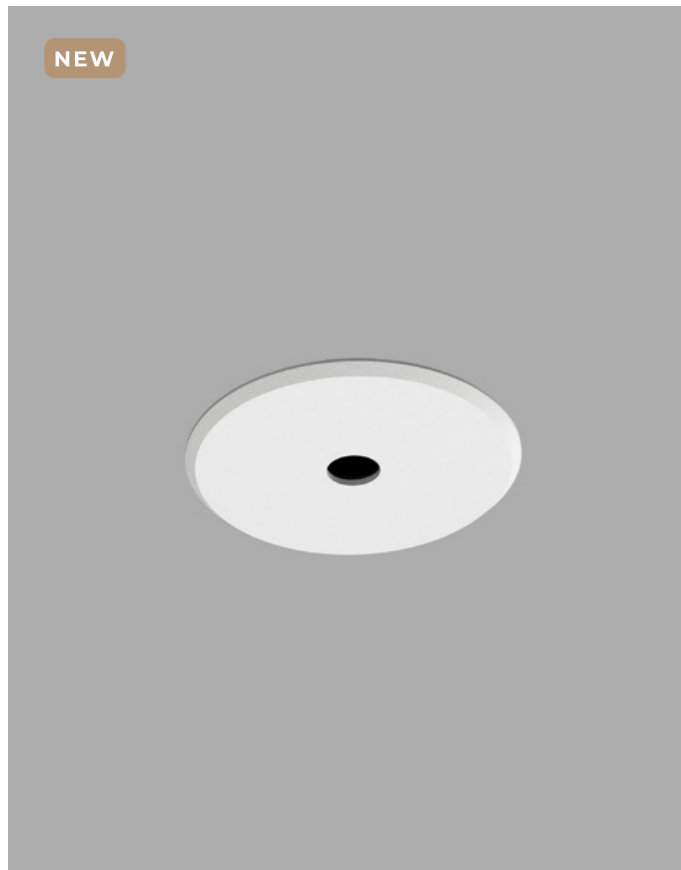

Recessed Canopy
LR.A02.RRC.WH



DESCRIPTION

Nestled discreetly within your ceiling, the Recessed Canopy provides a sleek aesthetic that not only elevates the visual appeal of your pendant lights but also ensures a seamless installation. Particularly ideal for cluster installations, its unobtrusive presence allows your chosen pendant to shine as the focal point.

PRODUCT DETAILS

Application
Indoor Pendant Light

Dimensions
Ø5CM

Materials
Aluminium, Metal

Finish
White

Maximum Load
8kg

Cut out size
3.5CM - 4.4CM

Ceiling Thickness
1CM - 2CM

NOTES

This lighting solution effortlessly combines form and function, bringing a touch of modern elegance to your lighting selection.

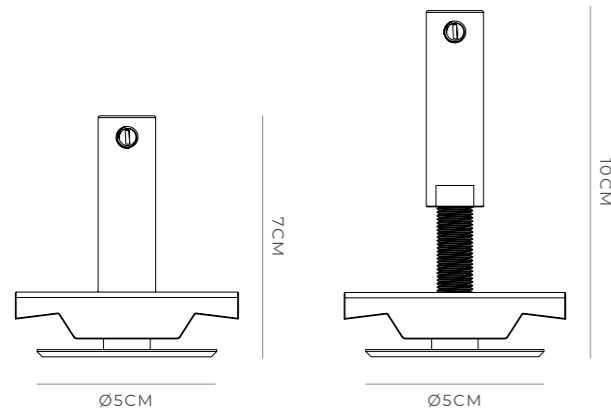

Recessed Canopy
White

CREDITS



ORB MAX PENDANT LIGHT

Pages: 14, 18
Photographer: Simon Whitbread
Interior Design: Arthouse Projects

Pages: 16, 17
Photographer: Coastpark Creative
Interior Design: Loni Parker

PARLOUR PENDANT LIGHT

Page: 31
Photographer: Sue Ferris
Interior Design: Heidi Alberiti

DOVER PENDANT LIGHT

Page: 58
Photographer: Hayley Haynes
Interior Design: Life Home Builders

BODE WALL LIGHT

Pages: 66, 69
Photographer: Pablo Veiga
Interior Design: Tom Mark Henry

SHADOW WALL LIGHT

Page: 74
Photographer: Joel Noon
Interior Design: Vision Design Studio

ORB MIRROR WALL LIGHT

Pages: 77, 81
Photographer: Villa Styling
Interior Design: Studio Lux

Pages: 78, 79
Photographer: Coastpark Creative
Interior Design: Loni Parker

ORB LONG ARM WALL LIGHT

Page: 84
Photographer: Sue Ferris
Interior Design: Heidi Alberiti

ORB SUR WALL LIGHT

Pages: 90, 91
Photographer: Coastpark Creative
Interior Design: Loni Parker

LILLE WALL LIGHT

Page: 113
Photographer: Sue Ferris
Interior Design: Heidi Alberiti

LILLE 2LT WALL LIGHT

Page: 114
Photographer: Pamment Projects
Interior Design: Pamment Projects

LIGHTING
REPUBLIC.

lightingrepublic.com.au

